

Proportional-pressure regulators VPPE

FESTO

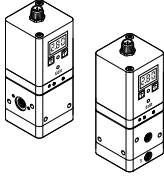

Product range overview

Function	Design	Pneumatic connection	Nominal width pressurisation/exhaust [mm]	Pressure regulation range		Setpoint input		→ Page/ Internet
				[MPa]	[bar]	Voltage type 0 ... 10 V	Current type 4 ... 20 mA	
Proportional- pressure regulator		G1/8	5/2.5	0.002 ... 0.2	0.02 ... 2	■	■	6
				0.006 ... 0.6	0.06 ... 6			
				0.01 ... 1	0.1 ... 10			

Peripherals overview

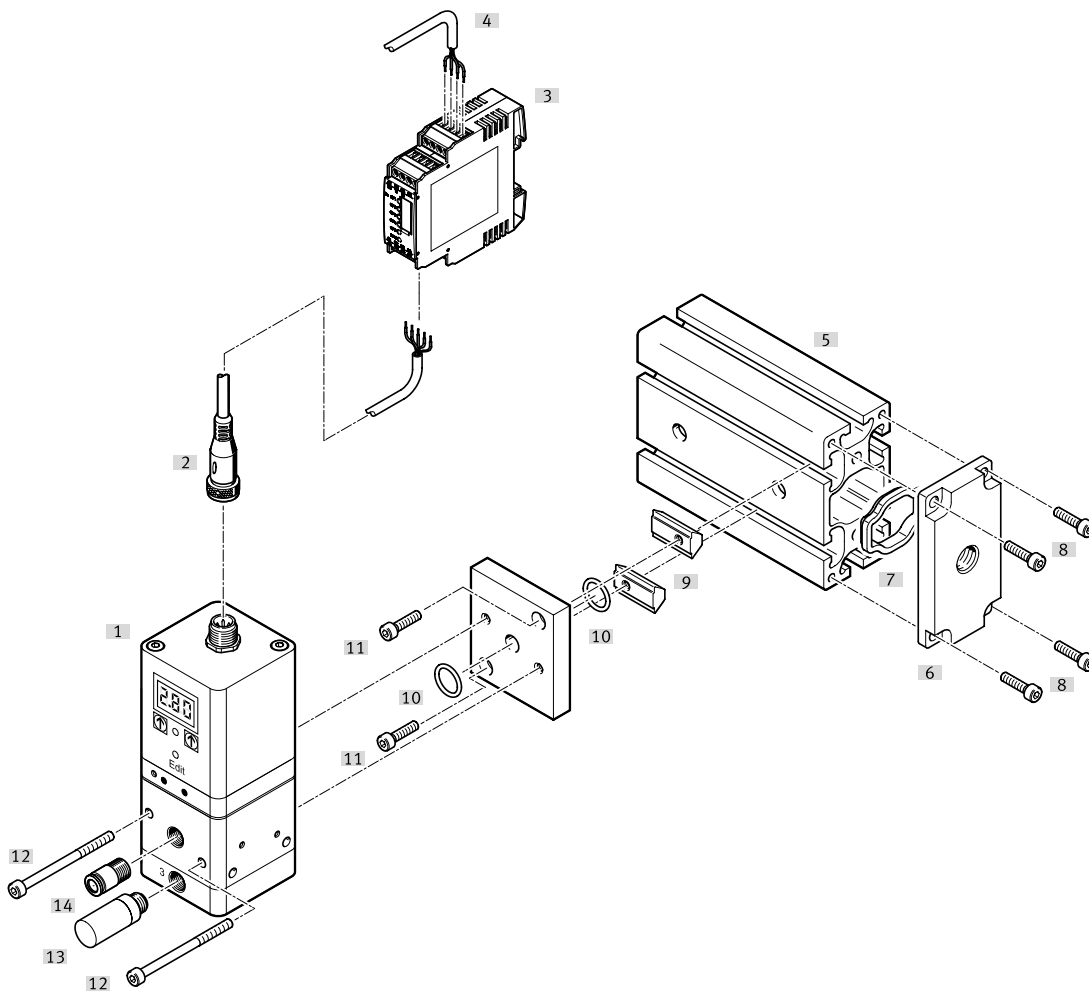

Accessories		Type	Description	→ Page/Internet
[1]	Prop.-pressure regulator	VPPE...	–	6
[2]	Connecting cable	SIM-M12-5GD-...-PU	With straight plug socket for actuating the VPPE	10
[3]	Setpoint module	MPZ	For generating 6+1 analogue voltage signals	10
[4]	Digital input/output	–	For actuating the setpoint module	–
[5]	Profile strip	–	Standard profile strip as central air supply	12
[6]	Compressed air supply plate (set)	VABF-P5-P3A3...	For supplying compressed air (consists of compressed air supply plate, screws and seal)	12
[7]	Seal	–	–	12
[8]	Socket head screw M5x12	–	For screwing the compressed air supply plate to the profile strip	12
[9]	Slot nuts	–	For clamp fastening on the profile strip	12
[10]	O-ring	–	For sealing	12
[11]	Socket head screw M4x16	–	For screwing the mounting plate to the slot nut	12
[12]	Socket head screw M4x55	–	For screwing the VPPE to the mounting plate	12
[13]	Silencer	U	For mounting in exhaust ports	u
[14]	Push-in fitting	QS	For connecting compressed air tubing with standard O.D.	quick star

Peripherals overview – Additional supply

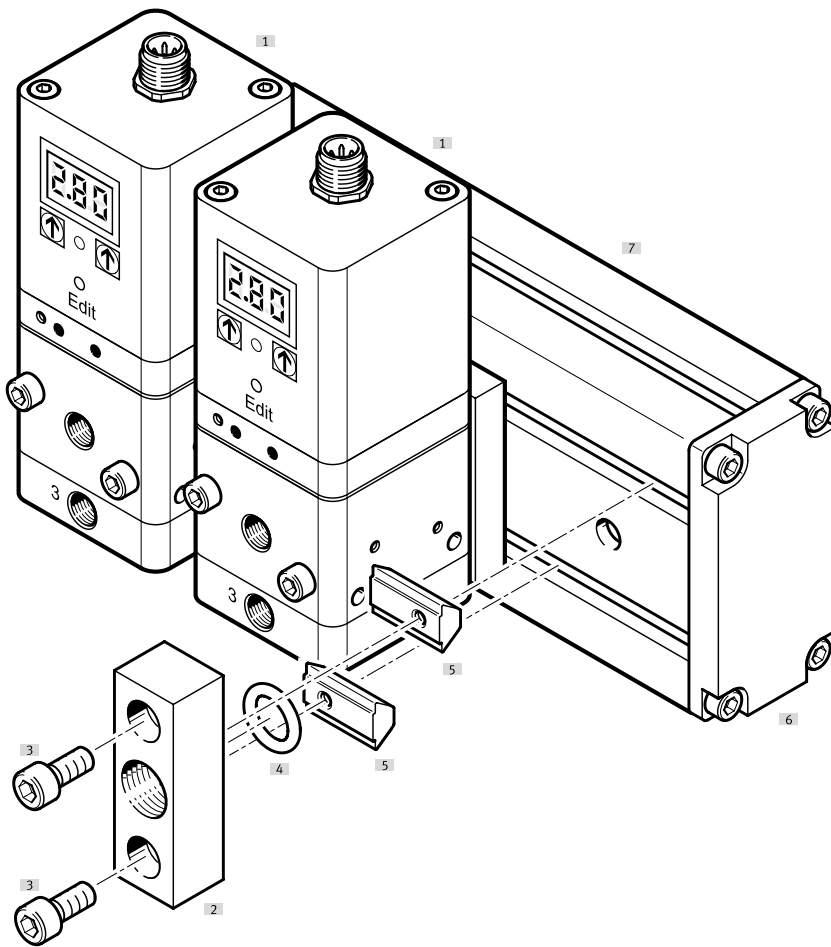

Accessories		Type	Description	→ Page/Internet
[1]	Prop.-pressure regulator	VPPE...	–	10
[2]	Additional supply (set)	VABF-P5-P1A3...	For supplying compressed air (consists of compressed air supply plate, screws and seal)	12
[3]	Socket head screw M6x20	–	For screwing the compressed air supply plate to the slot nut	12
[4]	O-ring	–	For sealing	12
[5]	Slot nuts	–	For clamp fastening on the profile strip	12
[6]	End plate (set)	VABE-P5-C	For sealing the profile strip (consists of an end plate, screws and seal)	12
[7]	Profile strip	–	Standard profile strip as central air supply	12

Type codes

001	Series	
VPPE	Proportional pressure regulator	

002	Valve function	
3	3-way valve	

003	Valve function	
1	Normally closed	

004	Pneumatic connection	
1/8	Female thread G1/8	

005	Pressure regulation range	
2	0.02 ... 2 bar	
6	0.06 ... 6 bar	
10	0.1 ... 10 bar	



006	Setpoint input for individual valves	
005	0 ... 5 V	
010	0 ... 10 V	
420	4 ... 20 mA	

007	Operator unit/interface	
E1	LED display, 7-segment	

008	Mounting	
	In-line valve	
T	Common supply manifold mounting (mounting rail)	

009	Special material properties	
	None	
F1A	Recommended for production facilities for the manufacture of lithium-ion batteries	

Data sheet

-  Flow rate
310 ... 1250 l/min
-  Voltage
21.6 ... 26.4 V DC
-  Pressure regulation ranges
0.002 ... 0.2 MPa
0.006 ... 0.6 MPa
0.01 ... 1 MPa

- Variants
- Setpoint input as analogue voltage signal 0 ... 10 V
 - Setpoint input as analogue current signal 4 ... 20 mA
 - Assembly as in-line valve or on profile strip
 - 3-digit LED display



General technical data

Pneumatic connection 1, 2, 3	G1/8		
Design, valve function	Piloted diaphragm regulator, 3-way prop.-pressure regulator		
Safety remark	Safety position VPPE		
Sealing principle	Soft		
Actuation type	Electrical		
Reset method	Mechanical spring		
Type of control	Piloted via 2/2-way valves		
Type of mounting	Via through-hole		
Mounting position	Any, preferably upright		
Nominal width	Pressurisation	[mm]	5
	Exhaust	[mm]	2.5
Standard nominal flow rate		[l/min]	→ graphs
Product weight		[g]	390

Flow rate qn as a function of output pressure p2

VPPE- ... -2- ...

qn 1 → 2

qn 2 → 3

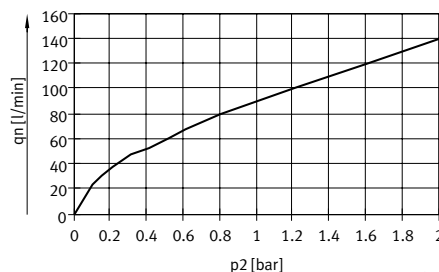
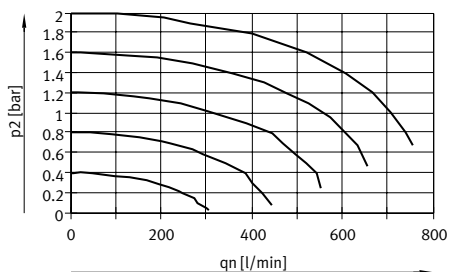

VPPE- ... -6- ...

qn 1 → 2

qn 2 → 3

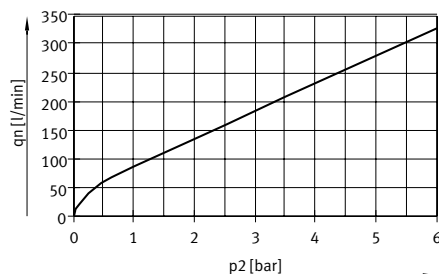
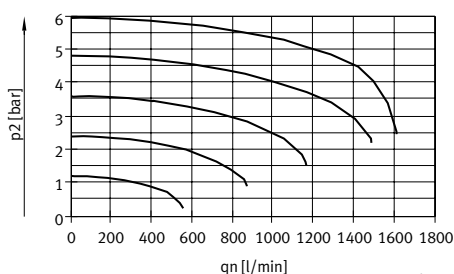

VPPE- ... -10- ...

qn 1 → 2

qn 2 → 3

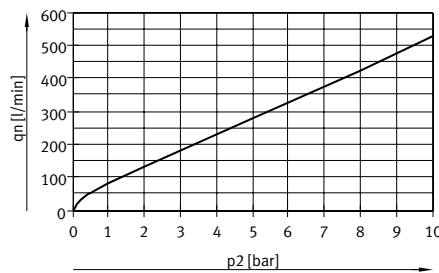
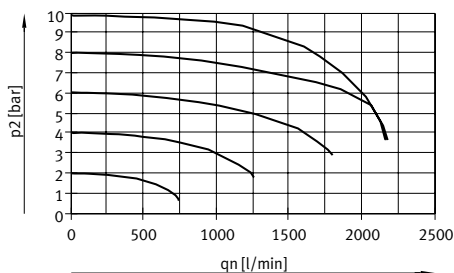

Data sheet

Electrical data				
Electrical connection	Plug, round design, 5-pin, M12x1			
Operating voltage range	[V DC]	21.6 ... 26.4		
Operating voltage indicator	LED			
Residual ripple	[%]	10		
Max. electrical power consumption	[W]	4.2		
Max. current consumption	[mA]	160		
Signal range for analogue output/input	Voltage	[V DC]	0 ... 10	
	Current	[mA]	4 ... 20	
Short circuit current rating	For all electrical connections			
Switching output	PNP			
Reverse-polarity protection	For all electrical connections			
Degree of protection	IP65			
Operating and environmental conditions				
Pressure regulation range	[MPa]	0.002 ... 0.2	0.006 ... 0.6	0.01 ... 1
	[bar]	0.02 ... 2	0.06 ... 6	0.1 ... 10
Operating medium	Compressed air to ISO 8573-1:2010 [7:4:4] Inert gases			
Note on the operating/pilot medium	Lubricated operation not possible			
Input pressure 1 ¹⁾	[MPa]	0.3 ... 0.4	0.6 ... 0.8	0.6 ... 1.1
	[bar]	3 ... 4	6 ... 8	6 ... 11
Max. pressure hysteresis	[MPa]	0.002	0.003	0.005
	[bar]	0.02	0.03	0.05
Hysteresis FS (full scale)	[%]	1	0.5	
Linearity error FS (full scale)	[%]	1		
Repetition accuracy FS (full scale)	[%]	0.5		
Overall accuracy FS (full scale)	[%]	1.5	1.25	
Temperature coefficient	[%/K]	0.04		
Duty cycle	[%]	100		
Ambient temperature	[°C]	0 ... 60		
Temperature of medium	[°C]	10 ... 50		
Corrosion resistance class	[CRC]	2 ²⁾		
CE marking (see declaration of conformity)	To EU EMC Directive ³⁾			
UKCA marking (see declaration of conformity)	To UK instructions for EMC			
Certification	RCM			
	c UL us listed (OL)			

1) Input pressure 1 should always be 1 bar greater than the maximum regulated output pressure.

2) More information: www.festo.com/x/topic/kbk

3) For information about the area of use, see the EC declaration of conformity at: www.festo.com/catalogue/... → Support/Downloads.

If the devices are subject to usage restrictions in residential, commercial or light-industrial environments, further measures for the reduction of the emitted interference may be necessary.

Data sheet

Pin allocation for VPPE, M12x1

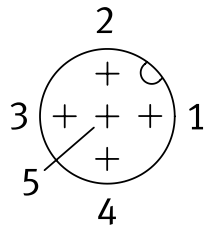

- 1 Supply
21.6 ... 26.4 V DC
- 2 Setpoint value (-)
- 3 GND (-)
- 4 Setpoint value (+) 0 ... 10 V DC /
4 ... 20 mA
- 5 Actual value output or switching
output (can be selected on the
operator panel)

Circuit symbol

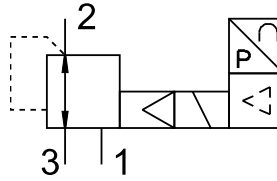

Materials

Housing	Anodised wrought aluminium alloy
Note on materials	RoHS-compliant Free of copper and PTFE
PWIS conformity	VDMA24364-B2-L

 **Note**

Output pressure remains unregulated if the supply cable is interrupted.

Data sheet

Dimensions

Download CAD data → www.festo.com

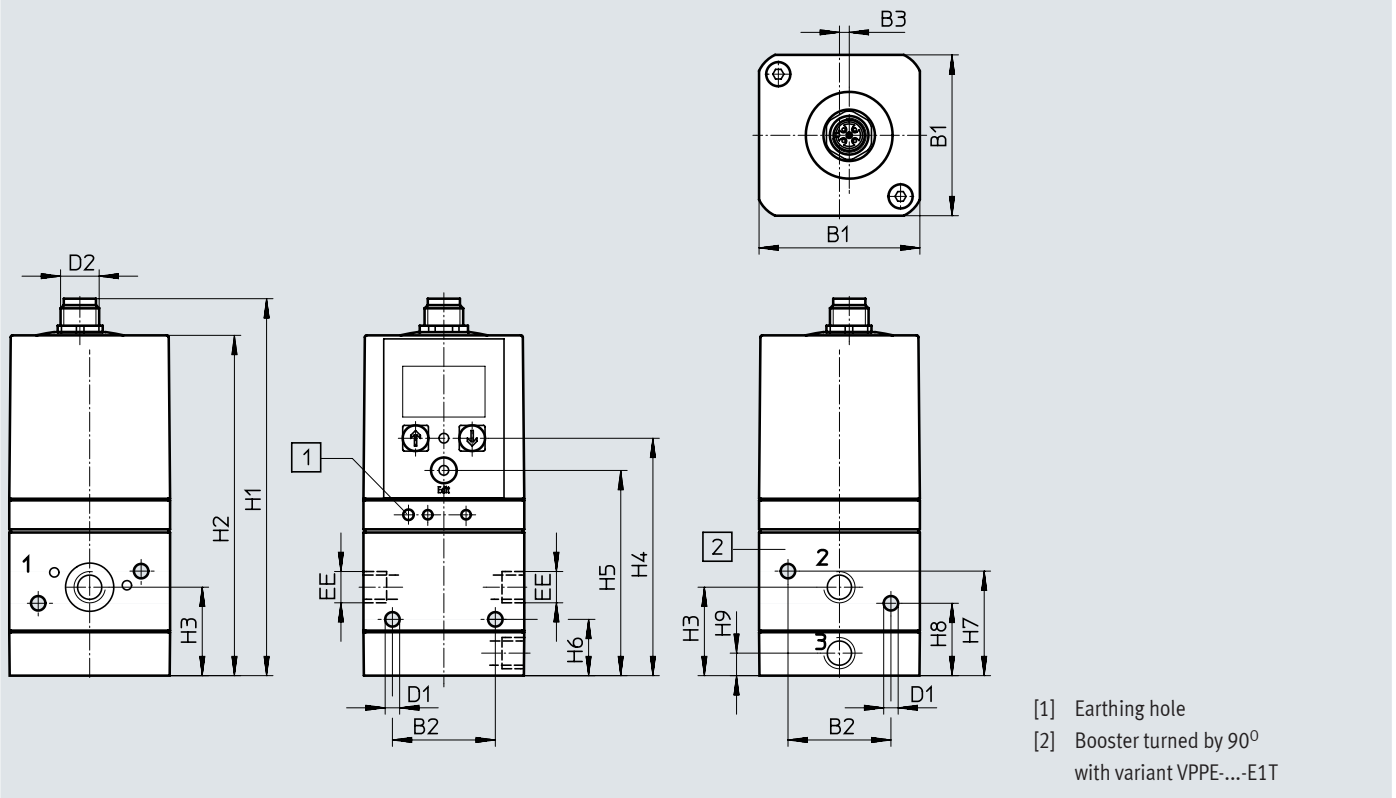

Type	B1	B2	B3	@ D1	D2	EE	H1	H2	H3	H4	H5	H6	H7	H8	H9
VPPE-3-1/8- ... E1 ...	50	32	3.1	4.5	M12x1	G1/8	117.2	105.8	27.5	73.8	63.8	17.5	32.5	22.5	7
VPPE-3-1/8- ... E1-F1A															

Ordering data

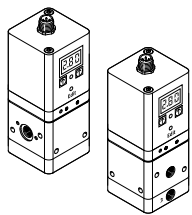
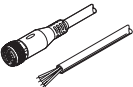
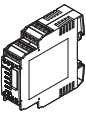
Ordering data		Description	Part no.	Type	
Proportional-pressure regulator VPPE					
	Voltage type 0 ... 10 V				
	Pressure regulation range 0.02 ... 2 bar	In-line valve	–	557771	VPPE-3-1-1/8-2-010-E1
		P manifold rail	–	557777	VPPE-3-1-1/8-2-010-E1T
	Pressure regulation range 0.06 ... 6 bar	In-line valve	–	557772	VPPE-3-1-1/8-6-010-E1
			Recommended for production systems for manufacturing lithium-ion batteries	8156419	VPPE-3-1-1/8-6-010-E1-F1A
		P manifold rail	–	567539	VPPE-3-1-1/8-6-010-E1T
	Pressure regulation range 0.1 ... 10 bar	In-line valve	–	557773	VPPE-3-1-1/8-10-010-E1
			Recommended for production systems for manufacturing lithium-ion batteries	8156420	VPPE-3-1-1/8-10-010-E1-F1A
		P manifold rail	–	557778	VPPE-3-1-1/8-10-010-E1T
	Voltage type 0 ... 5 V				
	Pressure regulation range 0.06 ... 6 bar	In-line valve	Recommended for production systems for manufacturing lithium-ion batteries	8156421	VPPE-3-1-1/8-6-005-E1-F1A
	Pressure regulation range 0.1 ... 10 bar			8156422	VPPE-3-1-1/8-10-005-E1-F1A
	Current type 4 ... 20 mA				
	Pressure regulation range 0.02 ... 2 bar	In-line valve	–	557774	VPPE-3-1-1/8-2-420-E1
		P manifold rail	–	557779	VPPE-3-1-1/8-2-420-E1T
Pressure regulation range 0.06 ... 6 bar	In-line valve	–	557775	VPPE-3-1-1/8-6-420-E1	
		Recommended for production systems for manufacturing lithium-ion batteries	8156423	VPPE-3-1-1/8-6-420-E1-F1A	
	P manifold rail	–	567540	VPPE-3-1-1/8-6-420-E1T	
Pressure regulation range 0.1 ... 10 bar	In-line valve	–	557776	VPPE-3-1-1/8-10-420-E1	
		Recommended for production systems for manufacturing lithium-ion batteries	8156424	VPPE-3-1-1/8-10-420-E1-F1A	
P manifold rail	–	557780	VPPE-3-1-1/8-10-420-E1T		
Connecting cable				Data sheets → Internet: nebu	
	Straight socket, M12x1, 5-pin Open end, 5-wire	2.5 m	175715	SIM-M12-5GD-2,5-PU	
		5 m	175716	SIM-M12-5GD-5-PU	
Setpoint module				Data sheets → Internet: mpz	
	Setpoint module for generating 6 + 1 analogue voltage signals		546224	MPZ-1-24DC-SGH-6-SW	

Data sheet

General information

Design

Some selected types of the pressure regulator VPPE can be screwed to a profile strip. This has the advantage that the profile strip can be used to create a central compressed air supply.

The air can be fed into the profile strip:

- at one end or
- at both ends through end plates,
- using an intermediate air supply module (in applications where an increased air rate is required).

The holes for the profile strip must be drilled according to the assembly instructions. The pressure regulators VPPE are screwed to the profile strip using the mounting plate. The end plates are screwed to the left and right end faces of the profile strip. See the

assembly instructions for further information:

→ Internet: vppe

Compressed air supply on the profile strip

When using the profile strip as a central compressed air supply, make sure that the required compressed air supply is guaranteed. Bear in mind that an intermediate air supply module needs

a valve position. The intermediate air supply module takes up one VPPE valve position.

Recommendation for compressed air supply

For example, with tubing diameter \varnothing 16 mm with simultaneous max. flow rate for all valves, the following applies:

Compressed air supply – number of valves:

- At one end – max. 5 valves
- At both ends – max. 10 valves
- With intermediate air supply module – max. 5 valves each

Note

- Intermediate air supply modules must always be centred on the profile strip.
- Multiple intermediate air supply modules must be evenly distributed.

Note

Only the following types of proportional-pressure regulators VPPE can be mounted on profile strips using a mounting plate:

- Valve VPPE with display and top part rotated by 90° VPPE-...

Further information on mounting proportional-pressure regulators VPPE as well as intermediate air supply modules on profile strips can be found in the assembly instructions:

→ Internet: vppe

Mounting plate (set) materials

Plate	Wrought aluminium alloy
Seals	NBR
Screws	Steel
Note on materials	RoHS-compliant
Corrosion resistance class	[CRC] 2 ¹⁾

1) More information: www.festo.com/x/topic/kbk

Mounting plate dimensions

Download CAD data → www.festo.com

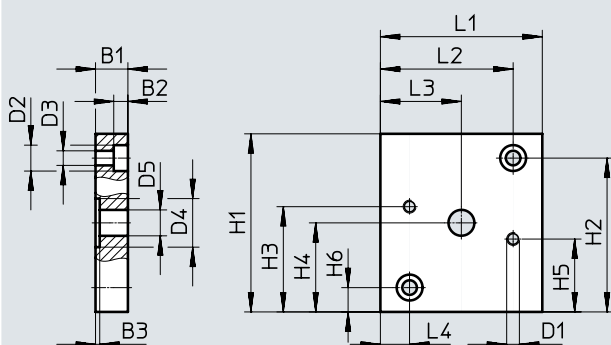

Type	B1	B2	B3	D1	@ D2	@ D3	@ D4	@ D5	H1	H2	H3	H4	H5	H6	L1	L2	L3	L4
VAME-P5-MK	10	4.6	1.3	M4	8	4.5	15	8	55	47.5	32.5	27.5	22.5	7.5	50	41	25	9

Ordering data

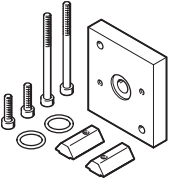
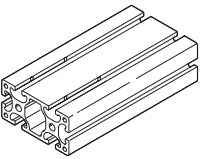
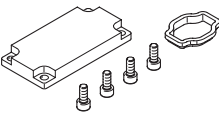
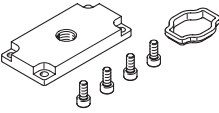
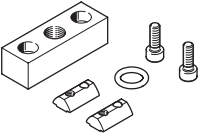
Ordering data	Description	Part no.	Type
Mounting plate set			
	Set comprising: <ul style="list-style-type: none"> • 1x mounting plate, weight: 110 g • 2x socket head screws M4X55 • 2x socket head screws M4X16 • 2x slot nuts • 2x O-rings 	570966	VAME-P5-MK
Profile column (profile strip)			
	Made from aluminium, as central air supply, length: individually adaptable	175964	HMBS-8 0/40- -
End plate set (closed)			
	For sealing the profile strip, consisting of: <ul style="list-style-type: none"> • 1x plate • 1x seal • 4x socket head screws M5x12 	8021858	VABE-P5-C
Compressed air supply plate set			
	With connecting thread G1/4, consisting of: <ul style="list-style-type: none"> • 1x plate with connecting thread G1/4 • 1x seal • 4x socket head screws M5x12 	8021859	VABF-P5-P3A3-G14
	With connecting thread G3/8, consisting of: <ul style="list-style-type: none"> • 1x plate with connecting thread G3/8 • 1x seal • 4x socket head screws M5x12 	8021860	VABF-P5-P3A3-G38
	With connecting thread G1/2, consisting of: <ul style="list-style-type: none"> • 1x plate with connecting thread G1/2 • 1x seal • 4x socket head screws M5x12 	8021861	VABF-P5-P3A3-G12
Additional supply set			
	Connection G1/4, consisting of: <ul style="list-style-type: none"> • 1x plate with connecting thread G1/4 • 1x O-ring • 2x slot nuts • 2x socket head screws M6x20 	8021862	VABF-P5-P1A3-G14
	Connection G3/8, consisting of: <ul style="list-style-type: none"> • 1x plate with connecting thread G3/8 • 1x O-ring • 2x slot nuts • 2x socket head screws M6x20 	8021863	VABF-P5-P1A3-G38

Festo - Your Partner in Automation



1 Festo Inc.
5300 Explorer Drive
Mississauga, ON L4W 5G4
Canada

Festo Customer Interaction Center
Tel: 1 877 463 3786
Fax: 1 877 393 3786
Email: customer.service.ca@festo.com



2 Festo Pneumatic
Av. Ceylán 3,
Col. Tequesquináhuac
54020 Tlalneptla,
Estado de México

Multinational Contact Center
01 800 337 8669
ventas.mexico@festo.com



3 Festo Corporation
1377 Motor Parkway
Suite 310
Islandia, NY 11749

Festo Customer Interaction Center
1 800 993 3786
1 800 963 3786
customer.service.us@festo.com



4 Regional Service Center
7777 Columbia Road
Mason, OH 45040

Connect with us



www.festo.com/socialmedia



www.festo.com

Subject to change