

Signal converter SVE4

FESTO



Product range and peripherals overview

Product range overview						
Type	Signal range	Switching output	Switching function	Electrical connection		→ Page
				Input	Output	
SVE4-US	0 ... 10 V	2x PNP	Freely programmable	Socket M8x1, 4-pin, to EN 60947-5-2	Plug M8x1, 4-pin, to EN 60947-5-2	4
SVE4-IS	0 ... 20 mA	2x NPN				
SVE4-HS	Adapted for position sensors SMH-S1-HG					

Peripherals overview

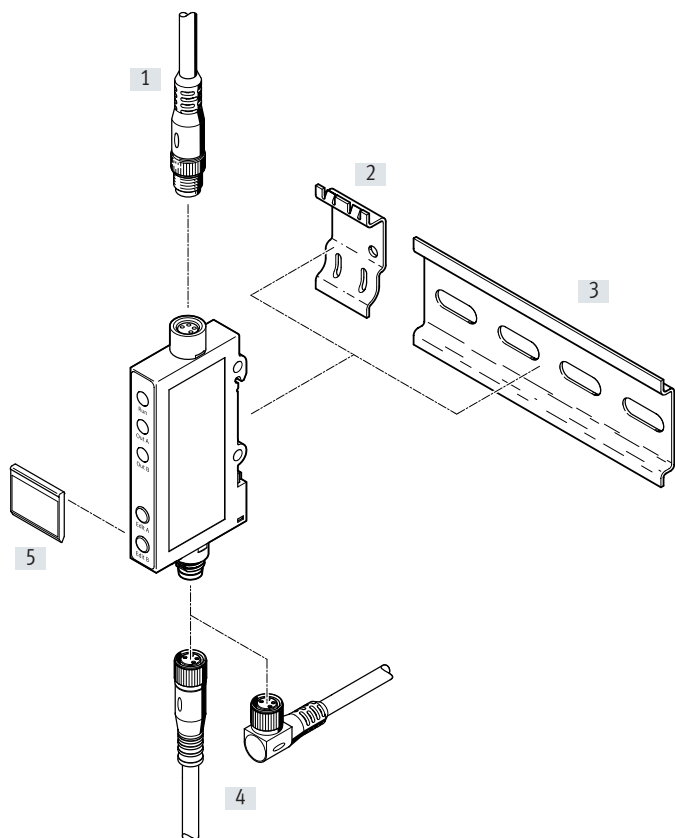

Mounting attachments and accessories			→ Page
[1]	Connecting cable for signal input NEBU		7
[2]	Adapter plate SXE3-W		7
[3]	Mounting rail to DIN EN 60715 NRH-35-2000		7
[4]	Connecting cable for switching output NEBU		7
[5]	Inscription label holder SXE3 (included in the scope of delivery)		-

Type codes

001	Series
SVE4	Signal converter

002	Signal range
US	0 ... 10 V
IS	0 ... 20 mA
HS	Adapted for position sensors SMH-S1-HG

003	Display and operation
R	Switching status indication with LED; teach-in buttons

004	Assembly
H	H-rail mounting

005	Electrical connection (signal input)
M8	Socket M8x1, 4-pin

006	Switching output
2P	2x PNP
2N	2x NPN

007	Electrical connection (switching output)
M8	Plug M8x1, 4-pin

Data sheet

Function

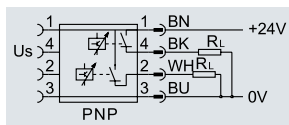

e.g. with switching output 2x PNP and signal range 0 ... 10 V

- Switching function freely programmable
- Choice of switching functions: N/O or N/C
- Switching points can be taught in
- Mounting via H-rail or adapter plate



General technical data

Certification	c UL us listed (OL) C-Tick
UL ambient temperature [°C]	-20 ... 60
CE marking (see declaration of conformity) ¹⁾	To EU EMC Directive
Note on materials	Free of copper and PTFE

¹⁾ For information about the area of use, see the EC declaration of conformity at: www.festo.com/catalogue/SVE4 → Support/Downloads.
If the devices are subject to usage restrictions in residential, commercial or light-industrial environments, further measures for the reduction of the emitted interference may be necessary.

Input signal/measuring element

Type	SVE4-US	SVE4-IS	SVE4-HS
Signal range	0 ... 10 ± 0.3 V	0 ... 20 ± 0.6 mA	Adapted for position sensors SMH-S1-HG
Ambient temperature [°C]	-20 ... +70		

Switching output

Switching output	2x PNP 2x NPN
Switching function	Freely programmable
Switching element function	Switchable

Output, additional data

Short circuit current rating	Pulsed
Overload protection	Available

Electronics

Type	SVE4-US	SVE4-IS	SVE4-HS
Operating voltage range [V DC]	10 ... 30		
Reverse polarity protection	For all electrical connections		For operating voltage and switching outputs

Electromechanics

Electrical connection, input	Socket M8x1, 4-pin, to EN 60947-5-2
Electrical connection output	Plug M8x1, 4-pin, to EN 60947-5-2

Mechanics

Product weight [g]	19
Information on materials: Housing	ABS

Data sheet

Display/operation	
Setting options	Teach-in
Immission/emission	
Degree of protection	IP65
Corrosion resistance class CRC ¹⁾	2

1) Corrosion resistance class CRC 2 to Festo standard FN 940070

Moderate corrosion stress. Indoor applications in which condensation can occur. External visible parts with primarily decorative surface requirements which are in direct contact with a normal industrial environment.

Signal range 0 ... 10 V¹⁾

Switching output 2x PNP

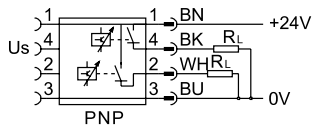

Switching output 2x NPN

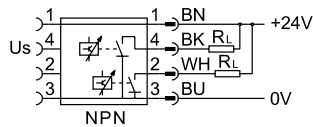

Pin allocation for input

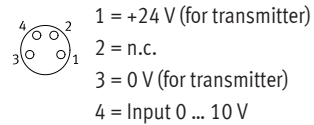

Pin allocation for output

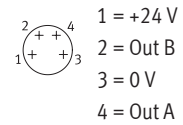
**Signal range 0 ... 20 mA¹⁾**

Switching output 2x PNP

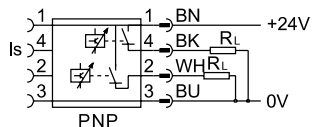

Switching output 2x NPN

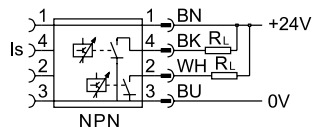

Pin allocation for input

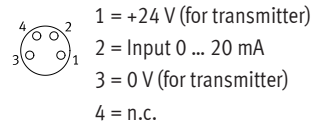

Pin allocation for output

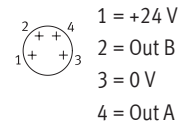
**Signal range adapted for position sensors SMH-S1-HG...¹⁾**

Switching output 2x PNP

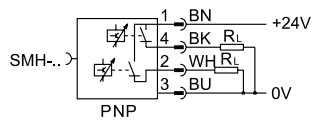

Switching output 2x NPN

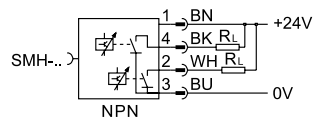

Adapted for position sensors
SMH-S1-HG

Pin allocation for output

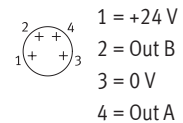

1) Wire colours as indicated apply when using plug sockets with cable NEBU-M8 or SIM-M8

Data sheet

Dimensions

Download CAD data → www.festo.com

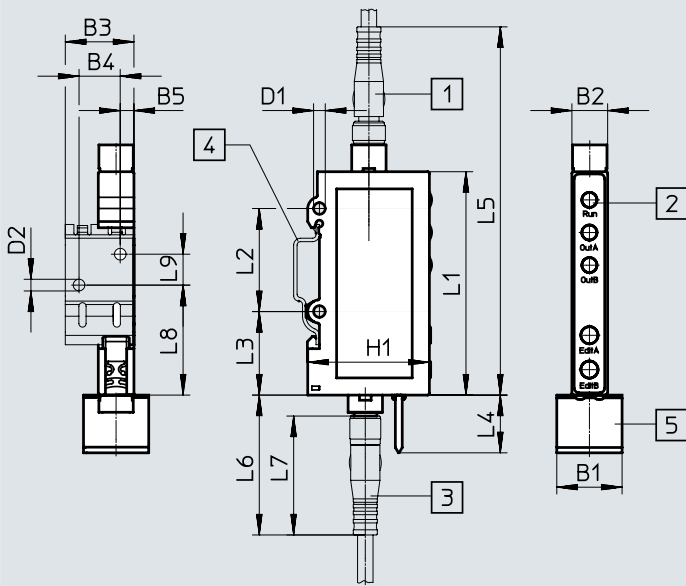

- [1] Plug M8x1, 4-pin
- [2] LED indicator
- [3] Socket M8x1, 4-pin
- [4] Adapter plate for wall mounting
- [5] Inscription label holder

Type	B1	B2	B3	B4	B5	D1 ∅	D2 ∅	H1	L1	L2	L3	L4	L5	L6	L7	L8	L9
SVE-...	20	10.4	20	12	4	3.4	3.4	35.4	65	30	24.3	17	108	40.7	34.6	32	9

Ordering data

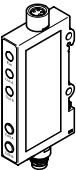
Design	Signal range	Switching output PNP		Switching output NPN	
		Part no.	Type	Part no.	Type
	0 ... 10 ± 0.3 V	544217	SVE4-HS-R-HM8-2P-M8	544220	SVE4-US-R-HM8-2N-M8
	0 ... 20 ± 0.6 mA	544218	SVE4-IS-R-HM8-2P-M8	544221	SVE4-IS-R-HM8-2N-M8
	Adapted for position sensors SMH-S1-HG	544216	SVE4-HS-R-HM8-2P-M8	544219	SVE4-HS-R-HM8-2N-M8

Accessories

Ordering data – Connecting cables for signal input

Data sheets → Internet: nebu

	Number of wires	Cable length [m]	Part no.	Type
M8x1, straight plug				
	4	2.5	554033	NEBU-M12G5-E-2.5-W3-M8G4-V2 ¹⁾
			554034	NEBU-M12G5-E-2.5-W2-M8G4-V1 ²⁾
			554035	NEBU-M8G4-K-2.5-M8G4 ³⁾



1) For connecting the signal converter SVE4-US to pressure transmitter SPTW....VD-M12.

2) For connecting the signal converter SVE4-IS to pressure transmitter SPTW....A-M12.

3) For connecting to position transmitter SMAF-8M.

Ordering data – Connecting cables for switching output

Data sheets → Internet: nebu

	Number of wires	Cable length [m]	Part no.	Type
M8x1, straight socket				
	4	2.5	541342	NEBU-M8G4-K-2.5-LE4
		5	541343	NEBU-M8G4-K-5-LE4
M8x1, angled socket				
	4	2.5	541344	NEBU-M8W4-K-2.5-LE4
		5	541345	NEBU-M8W4-K-5-LE4

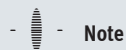

**Note**

Convenient configurator for easy selection of connecting cables

NEBU

→ www.festo.com/catalogue

Ordering data

		Part no.	Type
Adapter plate			
	For mounting the signal converter SVE4	540214	SXE3-W
DIN mounting rail			
	For mounting the signal converter SVE4	35430	NRH-35-2000

Festo - Your Partner in Automation



1 Festo Inc.
5300 Explorer Drive
Mississauga, ON L4W 5G4
Canada

Festo Customer Interaction Center
Tel: 1 877 463 3786
Fax: 1 877 393 3786
Email: customer.service.ca@festo.com

2 Festo Pneumatic
Av. Ceylán 3,
Col. Tequesquináhuac
54020 Tlalneantla,
Estado de México

Multinational Contact Center
01 800 337 8669
ventas.mexico@festo.com

3 Festo Corporation
1377 Motor Parkway
Suite 310
Islandia, NY 11749

Festo Customer Interaction Center
1 800 993 3786
1 800 963 3786
customer.service.us@festo.com

4 Regional Service Center
7777 Columbia Road
Mason, OH 45040

Connect with us



www.festo.com/socialmedia



www.festo.com

Subject to change