

## Pressure sensors SPAN

**FESTO**



Festo Core Range  
Solves the majority of your automation tasks

With the Festo Core Range, we have selected the most important products and functions from our broad product catalogue, and added the quickest delivery.

Worldwide: Quickest delivery – wherever, whenever  
Simply good: Expected high Festo quality  
Fast: Easy and fast to select

The Core Range offers you the best value for your automation tasks.

Just look  
for the  
star!

## Key features

### At a glance

#### Communication interface



#### Practical design

- Compact design 30x30 mm
- Degree of protection IP40
- Weight reduction with QS4

#### Universal pressure measurement

- Pressure and vacuum
- 14 pressure measuring ranges
- All standard pressure units
- Optional test report



#### Easy operation

- Clear display
- Configurable red surround for the entire display
- Intuitive menu navigation

#### Quick installation

- L1 plug for fast commissioning
- M8 electrical adapters allow maximum flexibility
- Wide range of mounting options
- QS4 quick connector

#### Switchable electrical outputs

- Various switching functions
- Switching outputs (PNP/NPN, NO/NC)
- Analogue outputs (0 ... 10 V, 1 ... 5 V, 4 ... 20 mA)

#### Product description

The pressure sensor SPAN is suitable for monitoring compressed air and non-corrosive gases. The sensor can be used in many industries thanks to its compact design. The measuring method is based on a piezoresistive measuring cell for relative pressure measurement. The pressure value is transmitted to the connected controller as a switching signal, as an analogue signal or via IO-Link depending on the sensor variant and selected parameters.

#### Area of application

- Network monitoring (pressure present)
- Regulator monitoring (pressure in the setpoint range)
- Vacuum (part picked up)
- Leak test (pressure drop over time)
- Object detection (back pressure present)

#### Functions

- Monitoring and setting a pressure threshold, a pressure range or differential pressure monitoring with teach-in function or by entering values
- ECO function with option to switch off the display
- Optional security code can be freely chosen (4-digit code)
- Adjustable low-pass filter to smooth the pressure signal
- Scaling the analogue output to increase the signal dynamics
- Offset compensation possible
- Min./max. value memory for monitoring compressed air
- All settings that have been carried out on one sensor (master) can be transferred (replication) to identical sensors (device)

#### Variants with IO-Link

- Serial communication integrated using IO-Link 1.1
- Cyclical transfer of two operating statuses and the measured pressure value
- The sensor can be parameterised remotely using an IO-Link master
- Sensor can be changed easily using automatic parameterisation (hot swap)
- Sensor identification, diagnostics and teach-in via IO-Link possible

#### 2-step connection

- [1] Push in L1 plug
- [2] Push in tubing

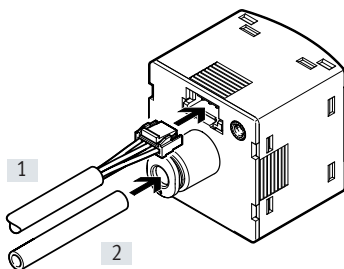

## Key features

### Mounting options

Front panel mounting

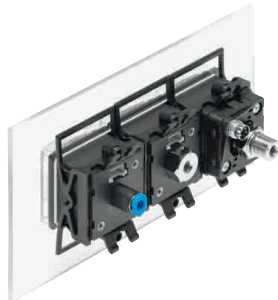

Manifold mounting with mounting bracket

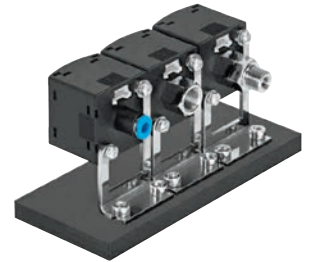
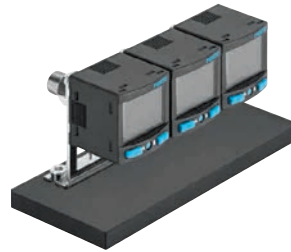

Threaded mounting with M8 adapter



Wall mounting

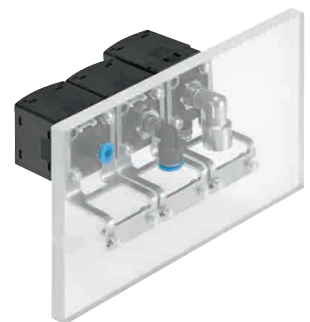
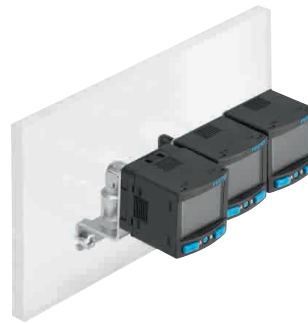

### Ordering data – Product options

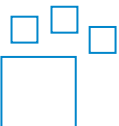

Configurable product  
This product and all its product options can be ordered using the configurator.

The configurator can be found under  
Products on the DVD or at  
→ [www.festo.com/catalogue/...](http://www.festo.com/catalogue/...)

Part no.	Type
8003300	SPAN

Product range overview

		<b>Basic variant</b> SPAN-B-...-PN-...	<b>Standard variant</b> <b>Switch</b> SPAN-...-PN-PN-...	<b>Standard variant</b> <b>IO-Link/analogue output</b> SPAN-...-PNLK-PNVBA-...
Pressure range		V1R, B2R, B11R	V1R, P10, B2R, B11R	All possible, see type codes for pressure measuring range
Switching output		1	2	2
Analogue output		-	-	Yes
IO-Link		-	-	Yes
Displayable units		6	9	9
Auto difference Monitoring		-	Yes	Yes
Pressure supply port	G18M/ R18M	Nickel-plated brass, short Without M5 female thread	Stainless steel, long With M5 female thread	Stainless steel, long With M5 female thread
	N18M-	-	Stainless steel, long With M5 female thread	Stainless steel, long With M5 female thread
	G18F-	Polymer	Stainless steel	Stainless steel
	M5F	Aluminium	Stainless steel	Stainless steel
	QS4-	Polymer/stainless steel	Polymer/brass	Polymer/brass
Mounting thread for Accessories		Polymer	Stainless steel	Stainless steel
Test report		-	Yes	Yes

Peripherals overview

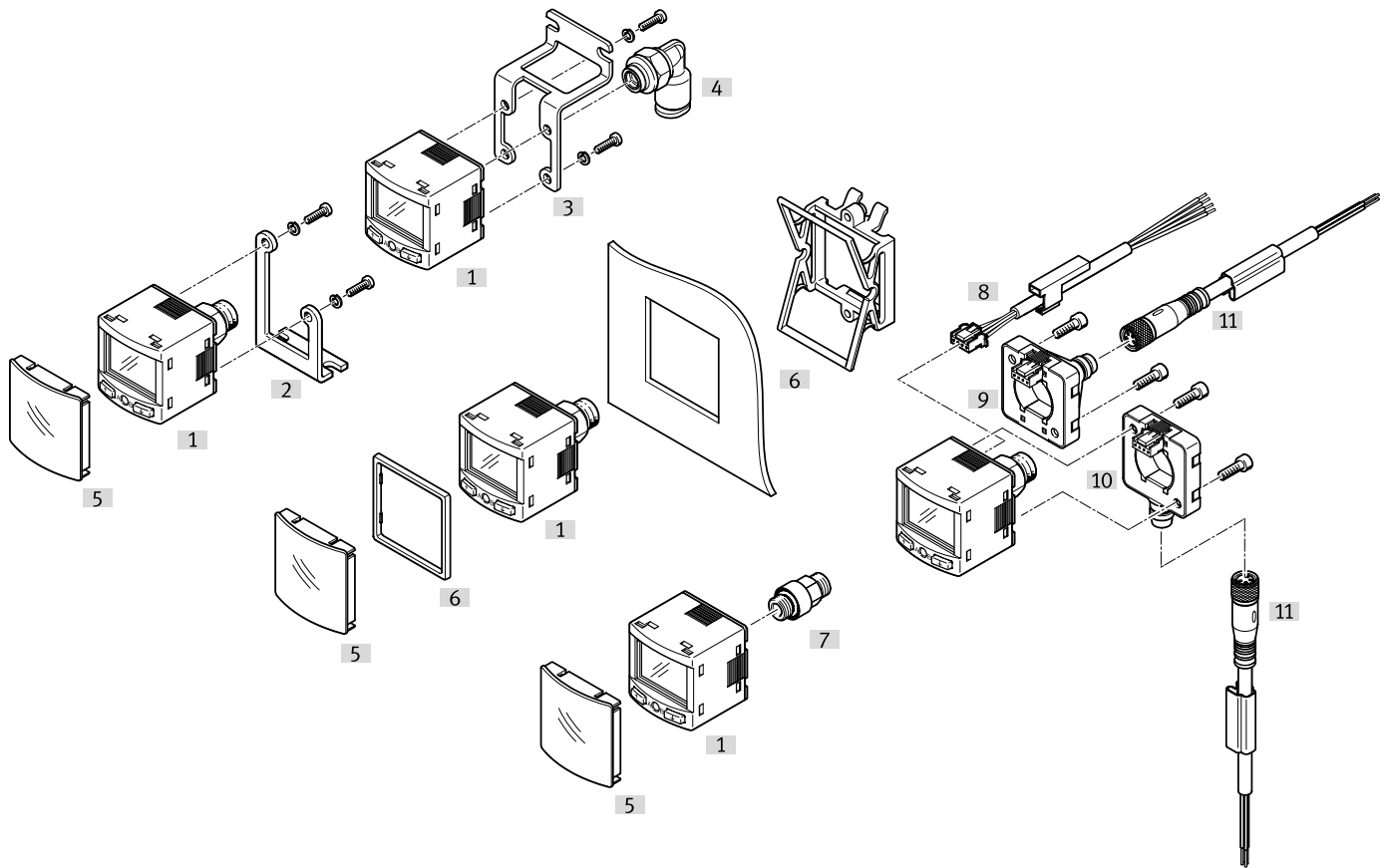

Accessories		→ Page	Accessories		→ Page
[1]	Pressure sensors SPAN-/SPAN-B-	7	[7]	Adapter (for -G18FPM- with electrical adapter) SASA-PN-A-MG18	18
[2]	Mounting bracket SAMH-PU-A	15	[8]	Connecting cable NEBS-L1G4	19
[3]	Wall mounting SAMH-PN-W	15	[9]	Electrical adapter SASC-P4-A-M8-S	17
[4]	Push-in fitting QSML-M5	19	[10]	Electrical adapter SASC-P4-A-M8-A	17
[5]	Safety guard SACC-PN-G	16	[11]	Connecting cable NEBU-M8	19
[6]	Panel mounting kit SAMH-PN-F	16			

## Type codes

<b>001</b>	<b>Series</b>
<b>SPAN</b>	Pressure sensor

<b>002</b>	<b>Product version</b>
	Standard
<b>B</b>	Basic

<b>003</b>	<b>Pressure measuring range</b>
<b>B2</b>	-1 ... 1 bar
<b>B02</b>	-0.1 ... 0.1 bar
<b>B11</b>	-1 ... 10 bar
<b>P025</b>	0 ... 0.25 bar
<b>P05</b>	0 ... 0.5 bar
<b>P1</b>	0 ... 1 bar
<b>P2</b>	0 ... 2 bar
<b>P6</b>	0 ... 6 bar
<b>P10</b>	0 ... 10 bar
<b>P12</b>	0 ... 12 bar
<b>P16</b>	0 ... 16 bar
<b>V025</b>	0 ... -0.25 bar
<b>V05</b>	0 ... -0.5 bar
<b>V1</b>	0 ... -1 bar

<b>004</b>	<b>Pressure inlet</b>
<b>R</b>	Relative pressure

<b>005</b>	<b>Pneumatic connection</b>
<b>G18</b>	G1/8
<b>R18</b>	R1/8
<b>N18</b>	1/8 NPT
<b>M5</b>	M5
<b>Q4</b>	Push-in connector 4 mm

<b>006</b>	<b>Thread type</b>
	None
<b>F</b>	Female
<b>M</b>	Male

<b>007</b>	<b>Thread material</b>
	Standard
<b>AL</b>	Aluminium
<b>PM</b>	Polymer

<b>008</b>	<b>Electrical output 1</b>
<b>PN</b>	PNP/NPN
<b>PNLK</b>	PNP/NPN/IO-Link

<b>009</b>	<b>Electrical output 2</b>
	None
<b>PN</b>	PNP or NPN
<b>PNVBA</b>	PNP or NPN or 0 ... 10 V or 1 ... 5 V or 4 ... 20 mA

<b>010</b>	<b>Electrical connection</b>
<b>L1</b>	Plug type L1

<b>011</b>	<b>Mounting accessories</b>
	None
<b>A</b>	Mounting bracket
<b>W</b>	Wall mounting
<b>FP</b>	Front panel mounting kit

<b>012</b>	<b>Electrical adapter</b>
	None
<b>EA</b>	Electrical adapter, angled
<b>ES</b>	Electrical adapter, straight

<b>013</b>	<b>Electrical accessories</b>
	None
<b>5S</b>	Straight socket, cable 5 m
<b>2.5S</b>	Straight socket, cable 2.5 m
<b>5A</b>	Angled socket, cable 5 m
<b>2.5A</b>	Angled socket, cable 2.5 m

<b>014</b>	<b>Protective devices</b>
	None
<b>G</b>	Protective hood

<b>015</b>	<b>Certificate</b>
	None
<b>T</b>	Test report

## Data sheet

Variant with IO-Link and analogue outputs ... -PNLK-PNVBA

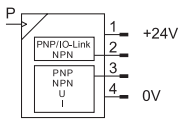

Variant with 2 switching outputs ... -PN-PN

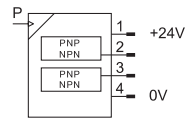

Variant with 1 switching output ... -B...-PN

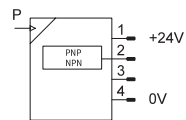

- Compact design 30x30
- 14 pressure measuring ranges  
-1 ... +16 bar available
- Voltage 12/24 V DC
- Temperature range 0 ... +50°C
- Degree of protection IP40



### General technical data

Certification	RCM c UL us - Listed (OL) <sup>1)</sup>
Certificate issuing authority	UL E322346
CE marking (see declaration of conformity)	To EU EMC Directive To EU RoHS Directive
UKCA marking (see declaration of conformity)	To UK instructions for EMC To UK RoHS instructions
Note on materials	RoHS-compliant

1) Not valid for SPAN-B

Input signal, measuring element		-B02	-B2	-B11	-V025	-V05	-V1	-P025	-P05	-P1	-P2	-P6	-P10	-P12	P16
Measured variable		Relative pressure													
Measurement method		Piezoresistive pressure sensor													
Pressure measuring range start value	[MPa]	-0.01	-0.1	-0.1	0										
	[bar]	-0.1	-1	-1	0										
	[psi]	-1.45	-14.5	-14.5	0										
Pressure measuring range end value	[MPa]	0.01	0.1	1	-0.025	-0.05	-0.1	0.025	0.05	0.1	0.2	0.6	1	1.2	1.6
	[bar]	0.1	1	10	-0.25	-0.5	-1	0.25	0.5	1	2	6	10	12	16
	[psi]	1.45	14.5	145	-3.62	-7.25	-14.5	3.62	7.25	14.5	29	87	145	174	232
Max. overload pressure	[MPa]	0.1	0.5	1.5	0.1	0.2	0.5	0.1	0.2	0.5	0.6	1.5	1.5	1.5	2.0
	[bar]	1	5	15	1	2	5	1	2	5	6	15	15	15	20
	[psi]	14.5	72.5	217.5	14.5	29	72.5	14.5	29	72.5	87	217.5	217.5	217.5	290
Operating medium		Compressed air to ISO 8573-1:2010 [7:4:4]													
		Inert gases													
Note on the operating/pilot medium		Lubricated operation possible													
Temperature of medium	[°C]	0 ... +50													
Ambient temperature	[°C]	0 ... +50													

Output, general		-B02	-B2	-B11	-V025	-V05	-V1	-P025	-P05	-P1	-P2	-P6	-P10	-P12	P16
Accuracy FS	[%]	±1.5													
Repetition accuracy	[%]	±0.3													
Temperature coefficient	[%FS/K]	±0.05 <sup>1)</sup>													

1) For SPAN-B: ±0.1 [%FS/K]

## Data sheet

Switching output		-PNLK-PNVBA	-PN-PN	-B-...-PN
SPAN-...				
Switching output		2x PNP or 2x NPN, switchable		1x PNP/NPN, switchable
Switching function		Window comparator		
		Threshold value comparator		
		Auto difference monitoring	-	
Switching element function		N/C or N/O, switchable		
Max. output current	[mA]	100	80	
Short circuit current rating		Yes		

Analogue output		-PNLK-PNVBA	-PN-PN	-B-...-PN
SPAN-...				
Analogue output	[V]	0 ... 10	-	-
	[V]	1 ... 5		
	[mA]	4 ... 20		
Max. load resistance of current output	[Ω]	500		
Min. load resistance of voltage output	[kΩ]	20		

IO-Link device to IEC 61131-9		-PNLK
SPAN-...		
Protocol		IO-Link
IO-Link		
Protocol version		Device V 1.1
Profile		Smart sensor profile
Function classes		Binary data channel (BDC)
		Process data variable (PDV)
		Identification
		Diagnostics
		Teach channel
Communication mode		COM2 (38.4 kBd)
SIO mode support		Yes
Port class		A
Process data width OUT		0 bytes
Process data width IN		2 bytes
Process data content IN		14 bit PDV (pressure measurement value)
		2 bit BDC (pressure monitoring)
Minimum cycle time		3 ms
Data memory required		0.5 KB

Electronics		SPAN-...	SPAN-B-...
Operating voltage range DC	[V]	15 ... 30	10.8 ... 30
Reverse polarity protection		For all electrical connections	
Electrical connection		Plug, 4-pin, square design	

Pin allocation		Pin	Wire colour	Allocation
	1	Brown	Operating voltage +24 V DC	
	2	Black	Switching output A / IO-Link	
	3	White	Switching output B / analogue output / not connected	
	4	Blue	0 V DC	



## Data sheet

Mechanics							
Pneumatic connection	Male thread G1/8	Male thread R1/8	Male thread R1/8, female thread M5	Male thread G1/8, female thread M5	Female thread M5	Female thread G1/8	For tubing O.D. 4 mm
Type of mounting	Front panel mounting, via thread, via wall/surface bracket						
Product weight	31 g		46 g		21 ... 34 g		21 ... 25 g
Mounting position	Any						
Information on materials: Housing	Reinforced PA						
Materials in contact with the media	FPM, brass, nickel-plated, reinforced PA		FPM, high-alloy stainless steel		Wrought aluminium alloy, anodised, FPM, reinforced PA, high-alloy stainless steel	FPM, reinforced PA, high-alloy stainless steel	FPM, NBR, reinforced PA
Suitable for the production of lithium-ion batteries <sup>1)</sup>	Metals with more than 1% copper, zinc or nickel by mass are excluded from use. Exceptions are nickel in steel, chemically nickel-plated surfaces, circuit boards, cables, electrical plug connectors and coils						

1) Not with variants SPAN-...-Q4, SPAN-B-...-G18M-..., SPAN-B-...-R18M-...

Materials in contact with the medium	SPAN						SPAN-B				
	-Q4	-M5F	-G18M	-R18M	-N18M	-G18F	-Q4	-M5F	-G18M	-R18M	-G18F
Anodised wrought aluminium alloy								•			
High-alloy stainless steel		•	•	•	•	•					
Nickel-plated brass									•	•	
Reinforced PA	•						•	•	•	•	•
FPM	•	•	•	•	•	•	•	•	•	•	•
NBR	•						•				

Display/operation			
SPAN	-PNLK	-PN-PN	-B-...-PN
Display type	Backlit LCD		
Displayable units <sup>1)</sup>	MPa		
	kPa		
	bar		
	mbar		–
	psi		
	inchH <sub>2</sub> O		–
	inchHg		
	kgf/cm <sup>2</sup>		–
Setting options	Teach-in		
	IO-Link	–	–
	Display and buttons		
Protection against tampering	IO-Link	–	–
	PIN code		
Threshold value setting range	[%]	0 ... 100	
Hysteresis setting range	[%]	0 ... 90	

1) Dependent on pressure measuring range

Immission/emission	
Degree of protection	IP40
PWIS conformity	VDMA24364-B1/B2-L
Corrosion resistance class CRC <sup>1)</sup>	2

1) Corrosion resistance class 2 to Festo standard 940070

Components subject to moderate corrosion stress. External visible parts with primarily decorative surface requirements which are in direct contact with the surrounding industrial environment or media such as coolants or lubricating agents.

Data sheet

Dimensions

Download CAD data → [www.festo.com](http://www.festo.com)

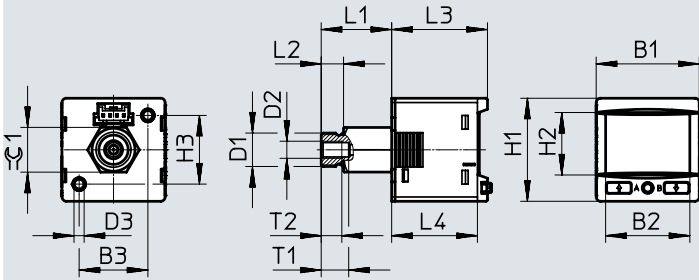

Type	B1	B2	B3	D1	D2	D3	H1	H2	H3	L1	L2	L3	L4	T1	T2	≅G1
SPAN-... -G18M-...	30	24.5	20	G1/8	M5	M3	30	18.2	20	20.5	6.5	~27.9	~25.3	8	6	13
SPAN-... -R18M-...				R1/8						22	8					
SPAN-... -N18M-...				1/8NPT						23.5	9.5					

Dimensions

Download CAD data → [www.festo.com](http://www.festo.com)

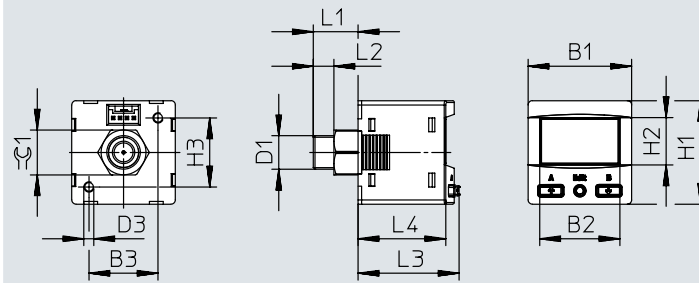

Type	B1	B2	B3	D1	D2	D3	H1	H2	H3	L1	L2	L3	L4	≅G1
SPAN-B-... -G18M-...	30	23.2	20	G1/8	-	M3	30	13.7	20	13	6	~29.3	~25.3	10
SPAN-B-... -R18M-...				R1/8						14	8			

Dimensions

Download CAD data → [www.festo.com](http://www.festo.com)

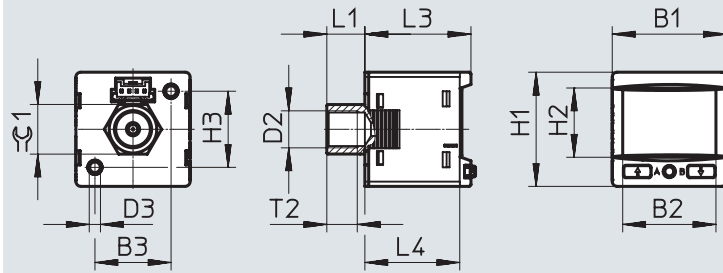

Type	B1	B2	B3	D2	D3	H1	H2	H3	L1	L3	L4	T2	≅G1
SPAN-... -G18F-...	30	24.5	20	G1/8	M3	30	18.2	20	10	~27.9	~25.3	8	13

## Data sheet

### Dimensions

Download CAD data → [www.festo.com](http://www.festo.com)

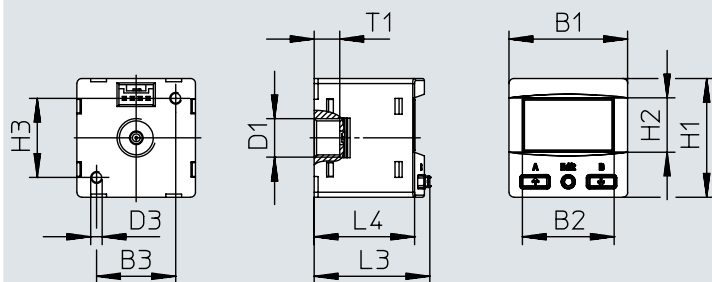

Type	B1	B2	B3	D1	D3	H1	H2	H3	L3	L4	T1
SPAN-B-...-G18FPM-...	30	23.2	20	G1/8	M3	30	13.7	20	~29.3	~25.3	6.5

### Dimensions

Download CAD data → [www.festo.com](http://www.festo.com)

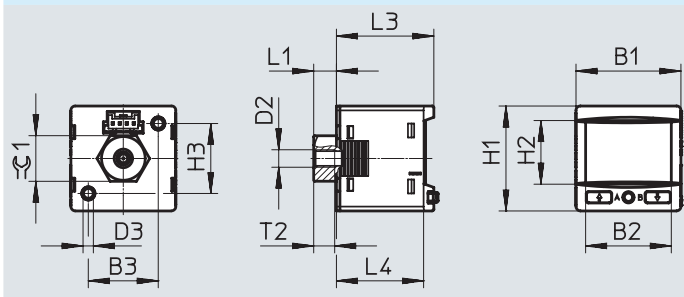

Type	B1	B2	B3	D2	D3	H1	H2	H3	L1	L3	L4	T2	~G1
SPAN-...-M5F-...	30	24.5	20	M5	M3	30	18.2	20	6.5	~27.9	~25.3	6	13

### Dimensions

Download CAD data → [www.festo.com](http://www.festo.com)

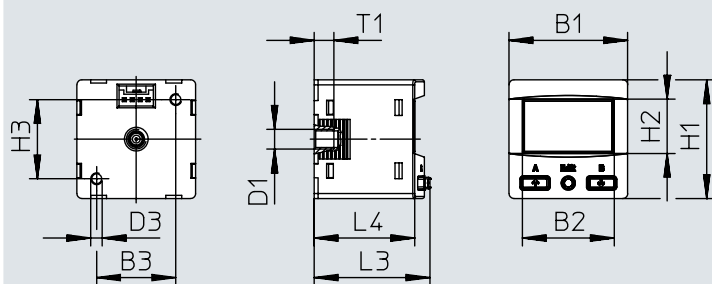

Type	B1	B2	B3	D1	D3	H1	H2	H3	L3	L4	T1
SPAN-B-...-M5FAL-...	30	23.2	20	M5	M3	30	13.7	20	~29.3	~25.3	5

Data sheet

Dimensions

Download CAD data → [www.festo.com](http://www.festo.com)

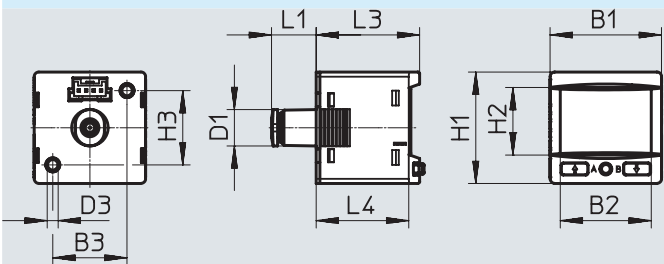

Type	B1	B2	B3	D1 ∅	D3	H1	H2	H3	L1	L3	L4
SPAN-...-Q4-...	30	24.5	20	9.8	M3	30	18.2	20	12	~27.9	~25.3

Dimensions

Download CAD data → [www.festo.com](http://www.festo.com)

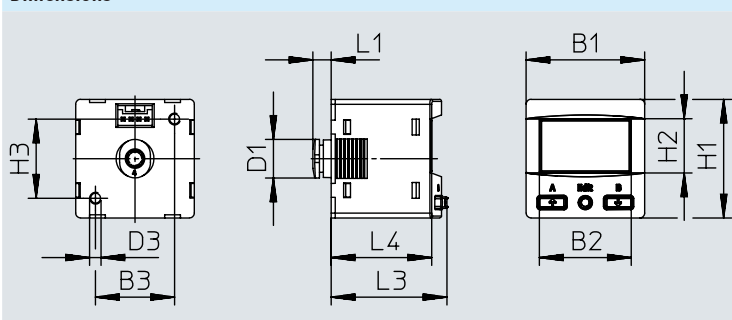

Type	B1	B2	B3	D1	D3	H1	H2	H3	L1	L3	L4
SPAN-B-...-Q4-PN-...	30	23.2	20	9.8	M3	30	13.7	20	4.6	~29.3	~25.3

## Data sheet

## ★ Core product range

Ordering data			Pneumatic connection	Part no.	Type
Switching output	Electrical output				
	Analogue output	Serial interface			
<b>Pressure measuring range -1 ... +1 bar</b>					
2x PNP/NPN, switchable	-	-	G1/8 male, M5 female	★ 8035545	SPAN-B2R-G18M-PN-PN-L1
			R1/8 male, M5 female	★ 8035548	SPAN-B2R-R18M-PN-PN-L1
			M5 female	★ 8035551	SPAN-B2R-M5F-PN-PN-L1
<b>Pressure measuring range 0 ... +10 bar</b>					
2x PNP/NPN, switchable	-	-	G1/8 male, M5 female	★ 8035544	SPAN-P10R-G18M-PN-PN-L1
			R1/8 male, M5 female	★ 8035547	SPAN-P10R-R18M-PN-PN-L1
<b>Ordering data</b>					
Ordering data			Pneumatic connection	Part no.	Type
Switching output	Electrical output				
	Analogue output	Serial interface			
<b>Pressure measuring range 0 ... -1 bar</b>					
2x PNP/NPN, switchable	-	-	G1/8 male, M5 female	8035546	SPAN-V1R-G18M-PN-PN-L1
			R1/8 male, M5 female	8035549	SPAN-V1R-R18M-PN-PN-L1
			Push-in connector 4 mm	8035554	SPAN-V1R-Q4-PN-PN-L1
	0 ... 10 V, 1 ... 5 V 4 ... 20 mA Switchable	IO-Link	G1/8 male, M5 female	8035535	SPAN-V1R-G18M-PNLK-PNVBA-L1
			R1/8 male, M5 female	8035538	SPAN-V1R-R18M-PNLK-PNVBA-L1
			Push-in connector 4 mm	8035543	SPAN-V1R-Q4-PNLK-PNVBA-L1
<b>Pressure measuring range -1 ... +1 bar</b>					
2x PNP/NPN, switchable	-	-	Push-in connector 4 mm	8035553	SPAN-B2R-Q4-PN-PN-L1
			0 ... 10 V, 1 ... 5 V 4 ... 20 mA Switchable	IO-Link	G1/8 male, M5 female
	R1/8 male, M5 female	8035537			SPAN-B2R-R18M-PNLK-PNVBA-L1
	M5 female	8035540			SPAN-B2R-M5F-PNLK-PNVBA-L1
	Push-in connector 4 mm	8035542	SPAN-B2R-Q4-PNLK-PNVBA-L1		
<b>Pressure measuring range 0 ... +10 bar</b>					
2x PNP/NPN, switchable	-	-	M5 female	8035550	SPAN-P10R-M5F-PN-PN-L1
			Push-in connector 4 mm	8035552	SPAN-P10R-Q4-PN-PN-L1
			G1/8 female	8134896	SPAN-P10R-G18F-PN-PN-L1
	0 ... 10 V, 1 ... 5 V 4 ... 20 mA Switchable	IO-Link	G1/8 male, M5 female	8035533	SPAN-P10R-G18M-PNLK-PNVBA-L1
			R1/8 male, M5 female	8035536	SPAN-P10R-R18M-PNLK-PNVBA-L1
			G1/8 female	8134897	SPAN-P10R-G18F-PNLK-PNVBA-L1
			M5 female	8035539	SPAN-P10R-M5F-PNLK-PNVBA-L1
			Push-in connector 4 mm	8035541	SPAN-P10R-Q4-PNLK-PNVBA-L1
			<b>Pressure measuring range: -1 ... +10 bar</b>		
2x PNP/NPN, switchable	-	-	R1/8 male, M5 female	8134891	SPAN-B11R-R18M-PN-PN-L1
			G1/8 male, M5 female	8134892	SPAN-B11R-G18M-PN-PN-L1
			M5 female	8134893	SPAN-B11R-M5F-PN-PN-L1
			Push-in connector 4 mm	8134894	SPAN-B11R-Q4-PN-PN-L1
	0 ... 10 V, 1 ... 5 V 4 ... 20 mA Switchable	IO-Link	G1/8 male, M5 female	609149	SPAN-B11R-G18M-PNLK-PNVBA-L1
			R1/8 male, M5 female	609554	SPAN-B11R-R18M-PNLK-PNVBA-L1
			M5 female	610282	SPAN-B11R-M5F-PNLK-PNVBA-L1
			Push-in connector 4 mm	8134895	SPAN-B11R-Q4-PNLK-PNVBA-L1

Data sheet SPAN-B

Ordering data					
Electrical output	Accessories	Pneumatic connection	Part no.	Type	
Switching output	Connecting cable				
<b>Pressure measuring range: 0 ... -1 bar</b>					
1x PNP/NPN, switchable	-	G1/8 male	8114752	SPAN-B-V1R-G18M-PN-L1	
		R1/8 male	8114755	SPAN-B-V1R-R18M-PN-L1	
		M5 female	8114758	SPAN-B-V1R-M5FAL-PN-L1	
		Tubing O.D. 4 mm	8114761	SPAN-B-V1R-Q4-PN-L1	
		G1/8 female	8114764	SPAN-B-V1R-G18FPM-PN-L1	
	NEBS-L1G4-K-2.5-LE4	G1/8 male	8114767	SPAN-B-V1R-G18M-PN-L1+2.5S	
		R1/8 male	8114770	SPAN-B-V1R-R18M-PN-L1+2.5S	
		M5 female	8114773	SPAN-B-V1R-M5FAL-PN-L1+2.5S	
		Tubing O.D. 4 mm	8114776	SPAN-B-V1R-Q4-PN-L1+2.5S	
		G1/8 female	8114779	SPAN-B-V1R-G18FPM-PN-L1+2.5S	
	<b>Pressure measuring range -1 ... +1 bar</b>				
	1x PNP/NPN, switchable	-	G1/8 male	8114751	SPAN-B-B2R-G18M-PN-L1
			R1/8 male	8114754	SPAN-B-B2R-R18M-PN-L1
			M5 female	8114757	SPAN-B-B2R-M5FAL-PN-L1
Tubing O.D. 4 mm			8114760	SPAN-B-B2R-Q4-PN-L1	
G1/8 female			8114763	SPAN-B-B2R-G18FPM-PN-L1	
NEBS-L1G4-K-2.5-LE4		G1/8 male	8114766	SPAN-B-B2R-G18M-PN-L1+2.5S	
		R1/8 male	8114769	SPAN-B-B2R-R18M-PN-L1+2.5S	
		M5 female	8114772	SPAN-B-B2R-M5FAL-PN-L1+2.5S	
		Tubing O.D. 4 mm	8114775	SPAN-B-B2R-Q4-PN-L1+2.5S	
		G1/8 female	8114778	SPAN-B-B2R-G18FPM-PN-L1+2.5S	
<b>Pressure measuring range: -1 ... +10 bar</b>					
1x PNP/NPN, switchable		-	G1/8 male	8114750	SPAN-B-B11R-G18M-PN-L1
			R1/8 male	8114753	SPAN-B-B11R-R18M-PN-L1
			M5 female	8114756	SPAN-B-B11R-M5FAL-PN-L1
	Tubing O.D. 4 mm		8114759	SPAN-B-B11R-Q4-PN-L1	
	G1/8 female		8114762	SPAN-B-B11R-G18FPM-PN-L1	
	NEBS-L1G4-K-2.5-LE4	G1/8 male	8114765	SPAN-B-B11R-G18M-PN-L1+2.5S	
		R1/8 male	8114768	SPAN-B-B11R-R18M-PN-L1+2.5S	
		M5 female	8114771	SPAN-B-B11R-M5FAL-PN-L1+2.5S	
		Tubing O.D. 4 mm	8114774	SPAN-B-B11R-Q4-PN-L1+2.5S	
		G1/8 female	8114777	SPAN-B-B11R-G18FPM-PN-L1+2.5S	

## Accessories – Ordering data

### Mounting bracket SAMH-PU-A

Type of mounting: via through-hole and screw. For mounting devices (standing or suspended) on even surfaces.

Material: High-alloy stainless steel

Note on materials: RoHS-compliant

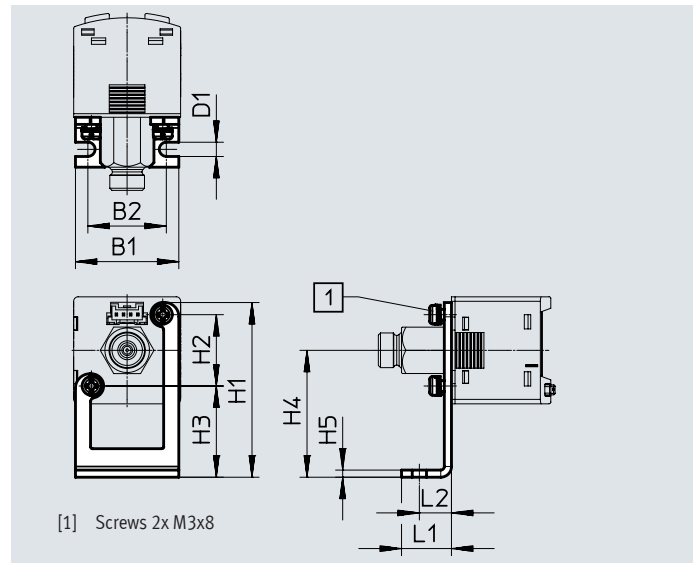

Ordering data													
Type	B1	B2	D1 ∅	H1	H2	H3	H4	H5	L1	L2	CRC <sup>1)</sup>	Part no.	Type
SAMH-PU-A	29	22	4	49	20	25.6	35.6	2	14	9	2	8003354	SAMH-PU-A

1) Corrosion resistance class 2 to Festo standard 940070

Components subject to moderate corrosion stress. External visible parts with primarily decorative surface requirements which are in direct contact with the surrounding industrial environment or media such as coolants or lubricating agents.

### Wall mounting SAMH-PN-W

Type of mounting: via through-hole and screw. For mounting devices on vertical surfaces.

Material: high-alloy stainless steel

Note on materials: RoHS-compliant

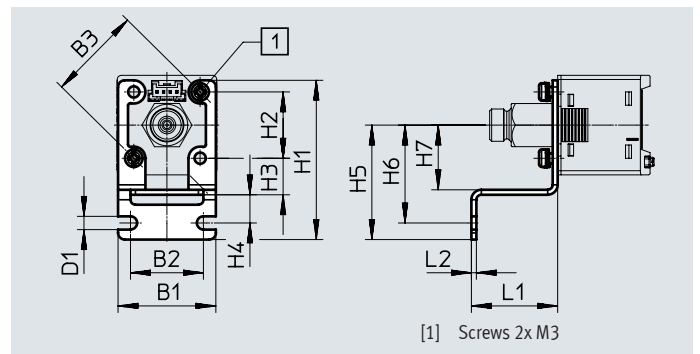
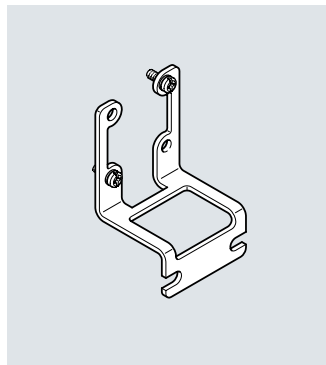

Dimensions and ordering data																
Type	B1	B2	B3	D1 ∅	H1	H2	H3	H4	H5	H6	H7	L1	L2	CRC <sup>1)</sup>	Part no.	Type
	±0.15		±0.3			±0.1							±0.05			
SAMH-PN-W	29.5	22	28.3	4	48	20	11	8.5	34.5	29.5	19.5	26	1.5	2	★ 8035563	SAMH-PN-W

1) Corrosion resistance class 2 to Festo standard 940070

Components subject to moderate corrosion stress. External visible parts with primarily decorative surface requirements which are in direct contact with the surrounding industrial environment or media such as coolants or lubricating agents.

## Accessories – Ordering data

### Safety guard

#### SACC-PN-G

To protect the display and control elements

Material: PA

Note on materials:

RoHS-compliant

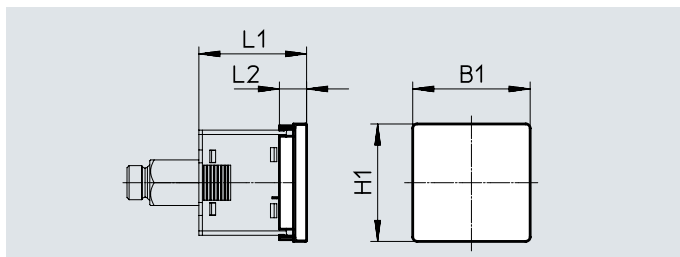

#### Dimensions and ordering data

Type	B1	H1	L1	L2	Part no.	Type
SACC-PN-G	33.5	33.5	-31	7.7	★ 8035560	SACC-PN-G

### Front panel mounting kit

#### SAMH-PN-F

Mounting kit for front panel

Material: PA, POM

Note on materials:

RoHS-compliant

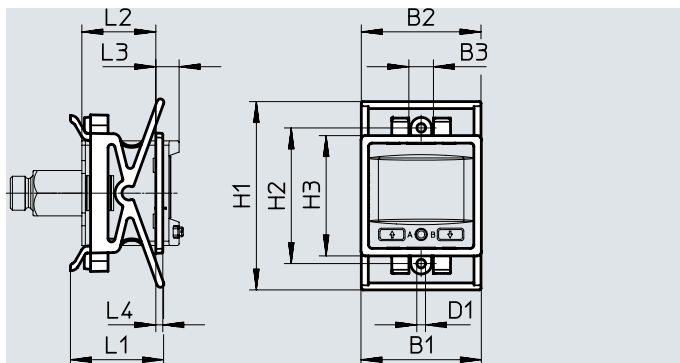

#### Dimensions and ordering data

Type	B1	B2	B3	D1 ø	H1		H2	H3	L1	L2	L3	L4	Part no.	Type
					min.	max.								
SAMH-PN-F	34.5	34.3	7	2.5	54	57.5	38.9	34.5	26.8	~21.2	~6.7	2	★ 8035561	SAMH-PN-F



## Accessories – Ordering data

### Electrical adapter SASC-P4-A-M8-A

For outlet direction underneath<sup>1)</sup>

Material of housing: Reinforced PA

Plug housing: Brass, nickel-plated

Note on materials:

RoHS-compliant

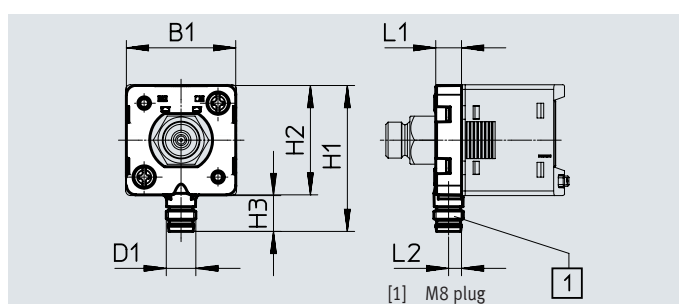

#### Dimensions and ordering data

Type	B1	D1	H1	H2	H3	L1	L2	CRC <sup>2)</sup>	Part no.	Type
SASC-P4-A-M8-A	29.6	M8x1	39.5	29.6	9.7	7	3.5	2	8000326	SASC-P4-A-M8-A

1) Only with connecting cable NEBU-M8-...

2) Corrosion resistance class CRC 2 to Festo standard FN 940070

Moderate corrosion stress. Indoor applications in which condensation can occur. External visible parts with primarily decorative surface requirements which are in direct contact with a normal industrial environment.

#### Pin allocation

Plug, 4-pin, M8x1

Round design	Pin	Core colour	Allocation
	1	Brown	Operating voltage +24 V DC
	2	White	Switching output B / analogue output / not connected
	3	Blue	0 V DC
	4	Black	Switching output A / IO-Link

### Electrical adapter SASC-P4-A-M8-S

For outlet direction to the rear<sup>1)</sup>

Material of housing: Reinforced PA

Plug housing: Brass, nickel-plated

Note on materials:

RoHS-compliant

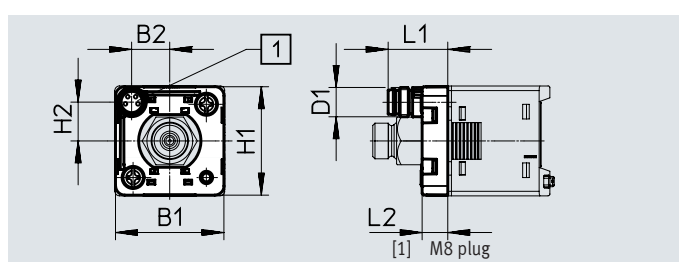

#### Dimensions and ordering data

Type	B1	B2	D1	H1	H2	L1	L2	CRC <sup>2)</sup>	Part no.	Type
SASC-P4-A-M8-S	29.6	10.4	M8x1	29.6	10.6	16.3	7	2	8000327	SASC-P4-A-M8-S

1) Only with connecting cable NEBU-M8-...

2) Corrosion resistance class CRC 2 to Festo standard FN 940070

Moderate corrosion stress. Indoor applications in which condensation can occur. External visible parts with primarily decorative surface requirements which are in direct contact with a normal industrial environment.

#### Pin allocation

Plug, 4-pin, M8x1

Round design	Pin	Core colour	Allocation
	1	Brown	Operating voltage +24 V DC
	2	White	Switching output B / analogue output / not connected
	3	Blue	0 V DC
	4	Black	Switching output A / IO-Link

## Accessories – Ordering data

### Adapters

#### SASA-PN-A-MG18

Material: Nickel-plated brass

Note on materials: RoHS-compliant

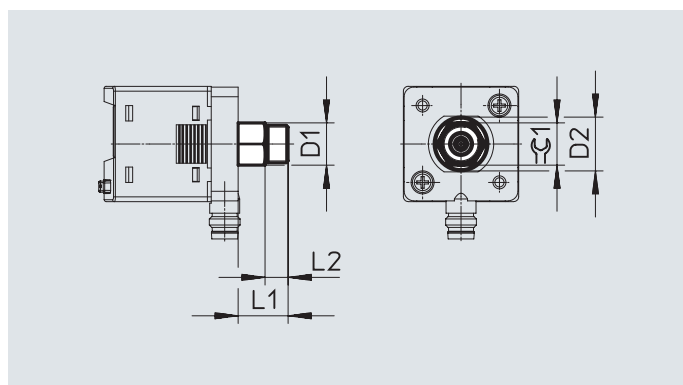









Dimensions and ordering data								
Type	D1	D2 ∅	L1	L2	CRC <sup>1)</sup>	≅ <sub>1</sub>	Part no.	Type
SASA-PN-A-MG18	G1/8	14	13	6	1	11	<b>8133310</b>	<b>SASA-PN-A-MG18</b>

1) Corrosion resistance class CRC 1 to Festo standard FN 940070

Low corrosion stress. Dry indoor application or transport and storage protection. Also applies to parts behind covers, in the non-visible interior area, and parts which are covered in the application (e.g. drive trunnions).

## Accessories – Ordering data

Ordering data – Connecting cables				
	Number of wires	Cable length [m]	Part no.	Type
<b>Socket, rectangular design L1</b> <span style="float: right;">Data sheets → Internet: nebs</span>				
	4	2.5	572576	NEBS-L1G4-K-2.5-LE4
		5	572577	NEBS-L1G4-K-5-LE4
<b>M8x1, straight socket</b> <span style="float: right;">Data sheets → Internet: nebu</span>				
	4	2.5	541342	NEBU-M8G4-K-2.5-LE4
		5	541343	NEBU-M8G4-K-5-LE4
<b>M8x1, angled socket</b>				
	4	2.5	541344	NEBU-M8W4-K-2.5-LE4
		5	541345	NEBU-M8W4-K-5-LE4
Ordering data – Push-in fittings <span style="float: right;">Data sheets → Internet: qs</span>				
	Pneumatic connection 1 With thread	Pneumatic connection 2 For tubing O.D. / with thread	Part no.	Type
<b>Straight connection</b>				
	M5	4 mm	★ 153304	QSM-M5-4
		6 mm	★ 153306	QSM-M5-6
	G1/8	4 mm	★ 186264	QSM-G1/8-4
		6 mm	★ 186265	QSM-G1/8-6
<b>90° connection</b>				
	M5	4 mm	★ 153333	QSML-5-4
		6 mm	★ 153335	QSML-5-6
	G1/8	4 mm	★ 186268	QSML-G1/8-4
		6 mm	★ 186269	QSML-G1/8-6
<b>90° connection</b> <span style="float: right;">Data sheets → Internet: npfc</span>				
	G1/8	G1/8	8030209	NPFC-L-2G18-F
	R1/8	R1/8	8030223	NPFC-L-2R18-M
	M5	M5	8030215	NPFC-L-2M5-MF
<b>Straight connection</b>				
	G1/8	G1/8	8133311	NPFC-D-2G18-M-F1A

# Festo - Your Partner in Automation



**1 Festo Inc.**  
5300 Explorer Drive  
Mississauga, ON L4W 5G4  
Canada

**Festo Customer Interaction Center**  
Tel: 1 877 463 3786  
Fax: 1 877 393 3786  
Email: [customer.service.ca@festo.com](mailto:customer.service.ca@festo.com)



**2 Festo Pneumatic**  
Av. Ceylán 3,  
Col. Tequesquináhuac  
54020 Tlalnepantla,  
Estado de México

**Multinational Contact Center**  
01 800 337 8669  
[ventas.mexico@festo.com](mailto:ventas.mexico@festo.com)



**3 Festo Corporation**  
1377 Motor Parkway  
Suite 310  
Islandia, NY 11749

**Festo Customer Interaction Center**  
1 800 993 3786  
1 800 963 3786  
[customer.service.us@festo.com](mailto:customer.service.us@festo.com)



**4 Regional Service Center**  
7777 Columbia Road  
Mason, OH 45040

Connect with us



[www.festo.com/socialmedia](http://www.festo.com/socialmedia)



[www.festo.com](http://www.festo.com)

Subject to change