

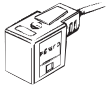
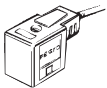
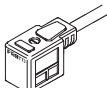
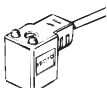
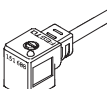
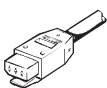
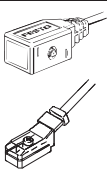

Plug sockets with cable

Product range overview

Design	Type	For solenoid coil (valves with solenoid coil)											→ Page
		D	E	EB	F	N1	N2	V	Y	Z	ZB	ZC	
	KMF	-	-	-	■	-	-	-	-	-	-	-	2 / 7.3-29
	KMC	■	-	-	-	■	-	-	-	-	-	2 / 7.3-30	
	KMV	-	-	-	-	-	-	■	-	-	-	2 / 7.3-31	
	KME	-	■	-	-	-	-	-	-	-	-	2 / 7.3-32	
	KMEB	-	-	■	-	-	■	-	-	-	-	2 / 7.3-33	
	KMY-1 - 1 KMYZ-1 - 1	-	-	-	-	-	-	-	■	■	-	2 / 7.3-35	
	KMYZ-2	-	-	-	-	-	-	-	-	-	■	2 / 7.3-36	
	KMYZ-3	-	-	-	-	-	-	-	-	-	■	2 / 7.3-37	
	KMYZ-4	-	-	-	-	-	-	-	-	-	■	2 / 7.3-38	
	KMYZ-4-...-B	-	-	-	-	-	-	-	-	-	■	2 / 7.3-38	
	KMYZ-6 - 1	-	-	-	-	-	-	-	-	-	■	2 / 7.3-40	
	KMYZ-9	-	-	-	-	-	-	-	-	-	■	2 / 7.3-41	

- 1 - To be discontinued

 Note
Allocation of solenoid coils to valve types → 2 / 7.1-1





Plug sockets with cable

Product range overview

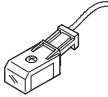

Valve accessories
Cables with sockets

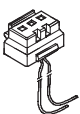
7.3

Design	Type	For miniature valves	For fast-switching valves	For proportional valves	For valves with central plug M12x1		→ Page
		MHA1...-PI/ MHP1...-PI	MH2/MH3	MPPE/MPPES	ISO 15 407-1	ISO 5599-1	
	KMYZ-3	-	■	-	-	-	2 / 7.3-37
	KMYZ-4-...-B	-	■	-	-	-	2 / 7.3-38
	KMH	■	-	-	-	-	2 / 7.3-42
	KMPPE-B	-	-	■	-	-	2 / 7.3-44
	KM12-M12-GSWD-1-4	-	-	-	■	■	2 / 7.3-45

Plug sockets with cable KMF

Technical data

-  - Temperature range
-20 ... +80°C

• For valves with F solenoid coils

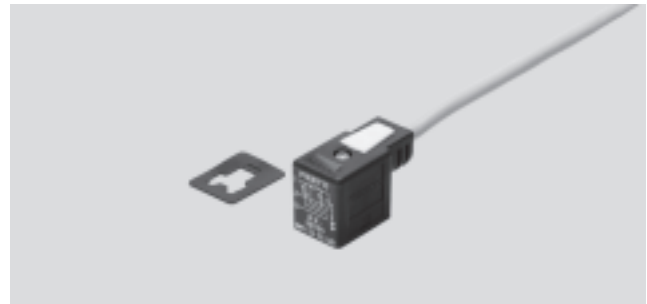



General technical data						
Operating voltage	24 V DC			0 ... 240 V DC/AC		
Cable length	[m]	2.5	5	10	2.5	5
Wire cross section	[mm ²]	3x0.75				
Number of pins	3					
Switching status display	LED					-
Type of mounting	M3 central screw					
Protection class to EN 60 529	IP67 (assembled)					
Mounting position	Any					
CE symbol	-					73/23/EEC (low voltage)
Ambient temperature	[°C]	-20 ... +80				
Product weight	[g]	170	320	460	170	320
Material	Housing	Polymer				
	Cable sheath	Polyvinyl chloride				

Dimensions

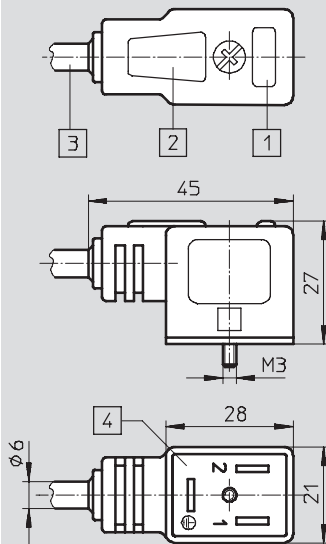
Download CAD data → www.festo.com/en/engineering

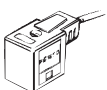

- 1 LED illuminated area
- 2 Location for inscription label
- 3 3-wire cable
- 4 Connection pattern for F solenoid coil

Ordering data						
	Description	Operating voltage	Switching status display with LED	Cable length [m]	Part No.	Type
	Plug socket with cable for valves with F solenoid coils	24 V DC		2.5	30 935	KMF-1-24DC-2,5-LED
				5	30 937	KMF-1-24DC-5-LED
				10	193 458	KMF-1-24-10-LED
		0 ... 240 V DC/AC	-	2.5	30 936	KMF-1-230AC-2,5
				5	30 938	KMF-1-230AC-5

Plug sockets with cable KMC

Technical data



- - Temperature range
-20 ... +80°C
- For valves with D and N1 solenoid coils

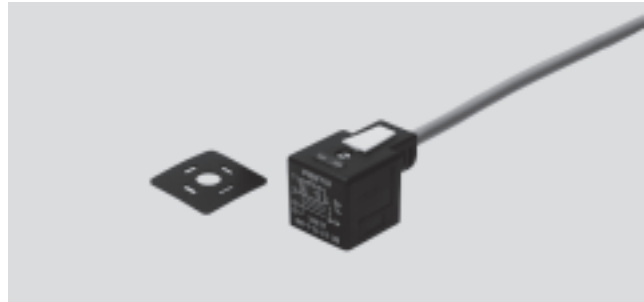

General technical data						
Operating voltage	24 V DC			0 ... 240 V DC/AC		
Cable length	[m]	2.5	5	10	2.5	5
Wire cross section	[mm ²]	3x0.75				
Number of pins	3					
Switching status display	LED					-
Type of mounting	M3 central screw					
Protection class to EN 60 529	IP67 (assembled)					
Mounting position	Any					
CE symbol	-				73/23/EEC (low voltage)	
Ambient temperature	[°C]	-20 ... +80				
Product weight	[g]	110	315	725	110	315
Material	Housing	Polymer				
	Cable sheath	Polyvinyl chloride				

Valve accessories
Cables with sockets

7.3

Dimensions Download CAD data → www.festo.com/en/engineering

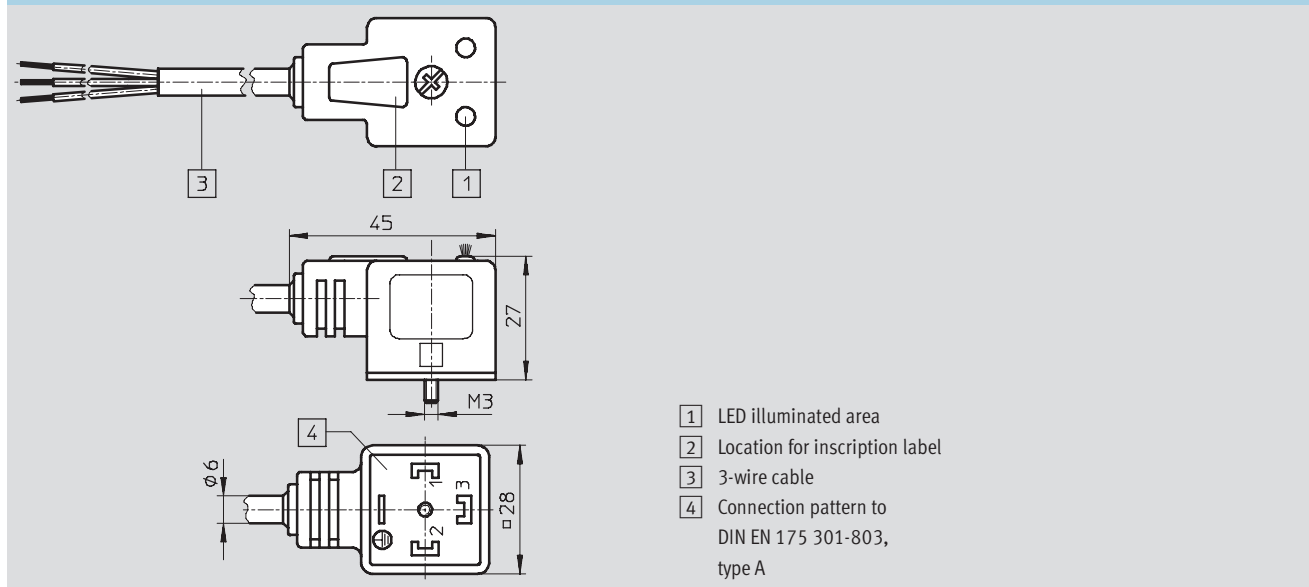

Ordering data						
	Description	Operating voltage	Switching status display with LED	Cable length [m]	Part No.	Type
	Plug socket with cable for valves with D and N1 solenoid coils	24 V DC		2.5	30 931	KMC-1-24DC-2,5-LED
				5	30 933	KMC-1-24DC-5-LED
				10	193 459	KMC-1-24-10-LED
		0 ... 240 V DC/AC	-	2.5	30 932	KMC-1-230AC-2,5
				5	30 934	KMC-1-230AC-5

Plug sockets with cable KMV

Technical data

Temperature range
-20 ... +80°C

• For valves with V solenoid coils

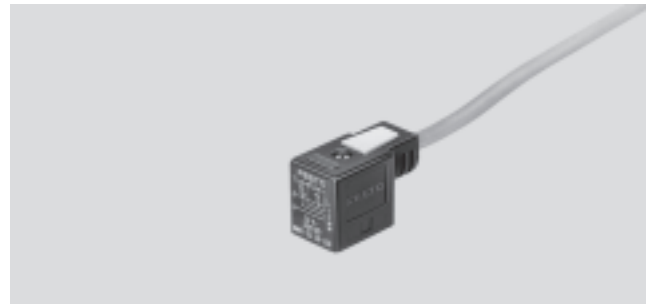

General technical data						
Operating voltage	24 V DC			0 ... 240 V DC/AC		
Cable length	[m]	2.5	5	10	2.5	5
Wire cross section	[mm ²]	3x0.75				
Number of pins		3				
Switching status display		LED			-	
Type of mounting		M3 central screw				
Protection class to EN 60 529		IP67 (assembled)				
Mounting position		Any				
CE symbol		-			73/23/EEC (low voltage)	
Ambient temperature	[°C]	-20 ... +80				
Product weight	[g]	165	320	630	165	320
Material	Housing	Polymer				
	Cable sheath	Polyvinyl chloride				

Dimensions

Download CAD data → www.festo.com/en/engineering

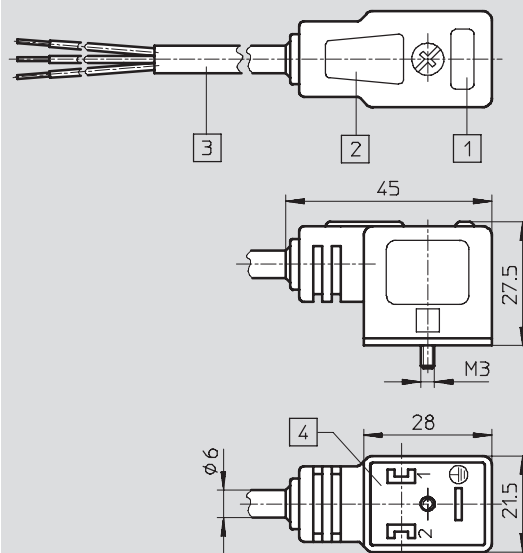

- 1 LED illuminated area
- 2 Location for inscription label
- 3 3-wire cable
- 4 Connection pattern to DIN EN 175 301-803, type B

Ordering data						
	Description	Operating voltage	Switching status display with LED	Cable length [m]	Part No.	Type
	Plug socket with cable for valves with V solenoid coils	24 V DC	■	2.5	30 939	KMV-1-24DC-2,5-LED
				5	30 941	KMV-1-24DC-5-LED
				10	193 456	KMV-1-24-10-LED
		0 ... 240 V DC/AC	-	2.5	30 940	KMV-1-230AC-2,5
				5	30 942	KMV-1-230AC-5

Plug sockets with cable KME

Technical data



Temperature range
 -20 ... +80°C

• For valves with E solenoid coils

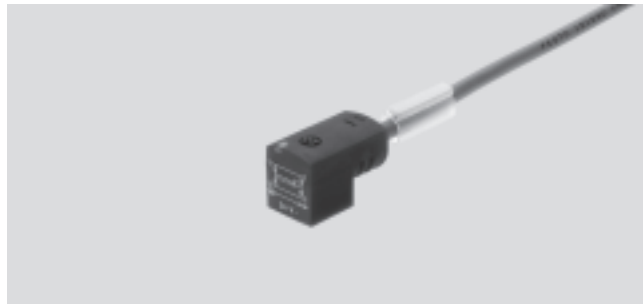

General technical data				
Cable length	[m]	2.5	5	10
Wire cross section	[mm ²]	2x0.75		
Number of pins		2		
Switching status display		LED		
Type of mounting		M3 central screw		
Mounting position		Any		
Protection class to EN 60 529		IP67 (assembled)		
Ambient temperature	[°C]	-20 ... +80		
Product weight	[g]	135	280	570
Material	Housing	Polymer		
	Cable sheath	Polyvinyl chloride		

Valve accessories
 Cables with sockets

7.3

Dimensions Download CAD data → www.festo.com/en/engineering

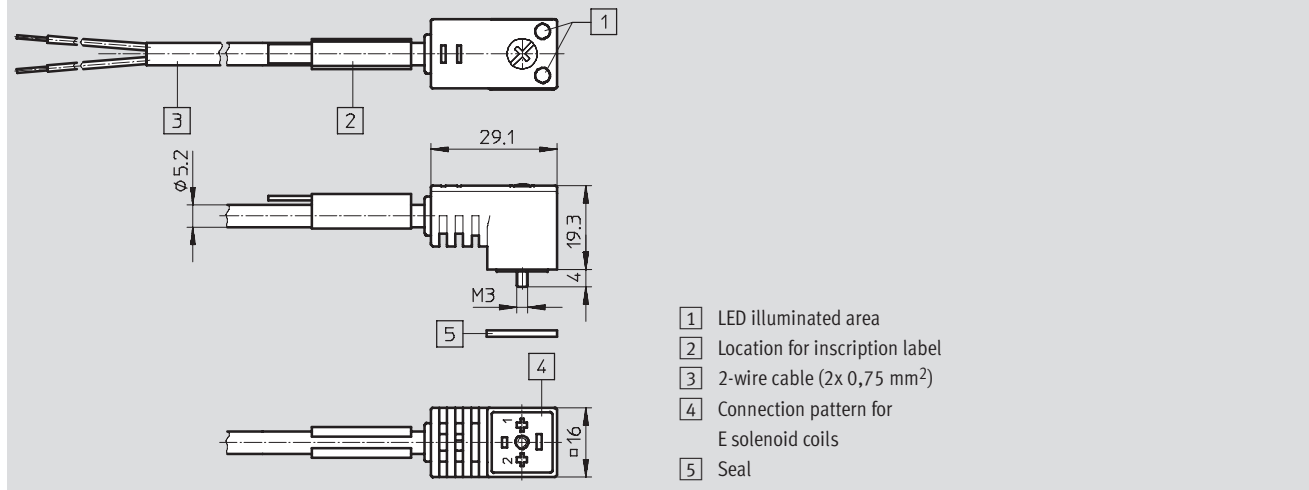

Ordering data						
	Description	Operating voltage	Switching status display with LED	Cable length [m]	Part No.	Type
	Plug socket with cable for valves with E solenoid coils	24 V DC		2.5	30 943	KME-1-24DC-2,5-LED
				5	30 945	KME-1-24DC-5-LED
				10	193 455	KME-1-24-10-LED

Plug sockets with cable KMEB

Technical data

-  - Temperature range
-20 ... +80°C

- For valves with EB solenoid coils
- KMEB-1 with PVC cable
- KMEB-2 with PUR cable

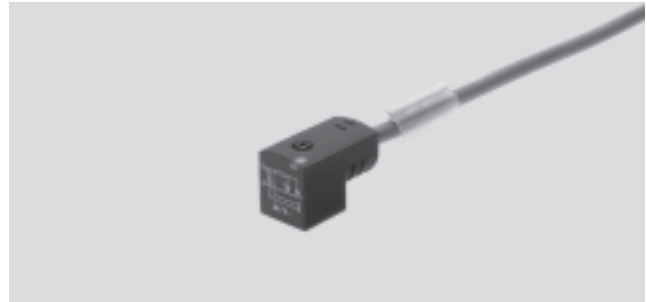

General technical data – KMEB-1						
Operating voltage	24 V DC			0 ... 240 V DC/AC		
Cable length	[m]	2.5	5	10	2.5	5
Wire cross section	[mm ²]	3x0.5				
Number of pins	3					
Switching status display	LED					-
Type of mounting	M2.5 central screw					
Protection class to EN 60 529	IP65 (assembled)					
Mounting position	Any					
CE symbol	-					73/23/EEC (low voltage)
Ambient temperature	[°C]	-20 ... +80				
Product weight	[g]	125	230	460	125	230
Material	Housing	Polymer				
	Cable sheath	Polyvinyl chloride				

Dimensions – KMEB-1

Download CAD data → www.festo.com/en/engineering

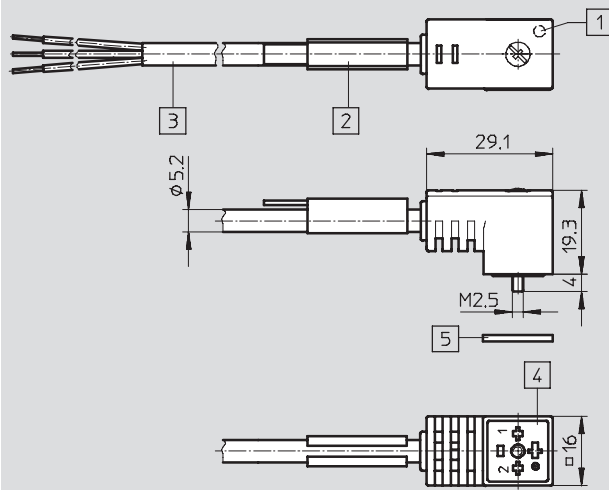

- 1 LED illuminated area
- 2 Location for inscription label
- 3 3-wire cable
- 4 Connection pattern to
DIN EN 175 301-803,
type C
- 5 Seal

Plug sockets with cable KMEB

Technical data



Valve accessories
Cables with sockets

7.3

General technical data – KMEB-2					
Operating voltage		24 V DC		0 ... 240 V DC/AC	
Cable length	[m]	2.5	5	2.5	5
Wire cross section	[mm ²]	3x0.75			
Number of pins		3			
Switching status display		LED	-		
Type of mounting		M2.5 central screw			
Protection class to EN 60 529		IP65 (assembled)			
Mounting position		Any			
CE symbol		-	73/23/EEC (low voltage)		
Ambient temperature	[°C]	-20 ... +80			
Product weight	[g]	200	400	200	400
Material	Housing	Polymer			
	Cable sheath	Polyurethane			

Dimensions – KMEB-2 Download CAD data → www.festo.com/en/engineering

- 1 LED illuminated area
- 2 Location for inscription label
- 3 3-wire cable
- 4 Connection pattern to DIN EN 175 301-803, type C

Ordering data

	Description	Operating voltage	Switching status display with LED	Cable length [m]	Part No.	Type
KMEB-1 (PVC cable)						
	Plug socket with cable for valves with EB solenoid coils	24 V DC	■	2.5	151 688	KMEB-1-24-2,5-LED
				5	151 689	KMEB-1-24-5-LED
				10	193 457	KMEB-1-24-10-LED
		0 ... 240 V DC/AC	-	2.5	151 690	KMEB-1-230AC-2,5
				5	151 691	KMEB-1-230AC-5
KMEB-2 (PUR cable)						
	Plug socket with cable for valves with EB solenoid coils	24 V DC	■	2.5	174 844	KMEB-2-24-2,5-LED
				5	174 845	KMEB-2-24-5-LED
		0 ... 240 V DC/AC	-	2.5	174 846	KMEB-2-230-2,5
				5	174 847	KMEB-2-230-5

Do not use for new designs!
 Type to be discontinued

Plug sockets with cable KMY-1/KMYZ-1

FESTO

Technical data



-  Temperature range
 -25 ... +80 (KMY-1)
 5 ... 50°C (KMYZ-1)
- For valves with Y and Z solenoid coils



General technical data					
Type		KMY-1	KMYZ-1		
Cable length	[m]	0.5	2.5	5	15
Wire cross section	[mm ²]	2x0.34			
Number of pins		2			
Type of mounting		Clip			
Protection class to EN 60 529		IP40 (assembled)			
Mounting position		Any			
Ambient temperature	[°C]	-20 ... +80	5 ... 50		
Product weight	[g]	4	70	155	325
Material	Housing	Polymer			
	Cable sheath	Polyvinyl chloride			

Valve accessories
 Cables with sockets

7.3

Dimensions		Download CAD data → www.festo.com/en/engineering
KMY-1	KMYZ-1	
 2-wire cable	 2-wire cable	

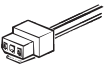
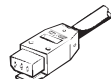
Ordering data						
		Description	Operating voltage	Cable length [m]	Part No.	Type
 	Plug socket with cable for valves with Y and Z solenoid coils	24 V DC	0.5	34 347	KMY-1-24-0,5	
			2.5	30 446	KMYZ-1-24-2,5	
			5	30 447	KMYZ-1-24-5	
			15	193 454	KMYZ-1-24-15	

Plug sockets with cable KMYZ-2

Technical data



Temperature range
-10 ... +50 °C

• For valves with ZB solenoid coils



General technical data		
Wire cross section	[mm ²]	2x0.25
Number of pins		2
Switching status display		LED
Type of mounting		Self-tapping central screw
Protection class to EN 60 529		IP65 (assembled)
Mounting position		Any
Ambient temperature	[°C]	-10 ... +50
Material	Housing	Polymer
	Cable sheath	Polyvinyl chloride

Dimensions Download CAD data → www.festo.com/en/engineering

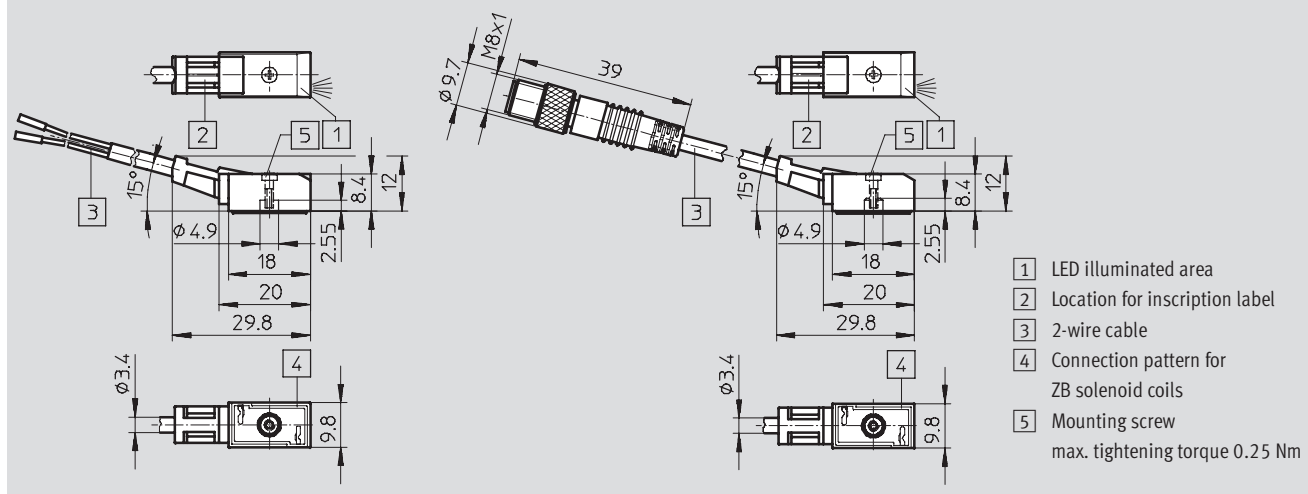

Ordering data							
	Description	Operating voltage	Switching status display with LED	Cable length [m]	Product weight [g]	Part No.	Type
	Plug socket with cable for valves with ZB solenoid coils	24 V DC	■	2.5	80	34 997	KMYZ-2-24-2,5-LED
				5	150	34 998	KMYZ-2-24-5-LED
				10	290	193 443	KMYZ-2-24-10-LED
	Plug socket with cable and plug M8x1 for valves with ZB solenoid coils	24 V DC	■	0.5		177 676	KMYZ-2-24-M8-0,5-LED
				2.5		177 678	KMYZ-2-24-M8-2,5-LED

Plug sockets with cable KMYZ-3

Technical data

Temperature range
-10 ... +50 °C

- For fast-switching valves MH2/MH3 with metric ZC solenoid coils



General technical data				
Cable length	[m]	2.5	5	10
Wire cross section	[mm ²]	2x0.25		
Number of pins		2		
Switching status display		LED		
Type of mounting		M2 central screw		
Protection class to EN 60 529		IP65 (assembled)		
Mounting position		Any		
Ambient temperature	[°C]	-10 ... +50		
Product weight	[g]	44	82	154
Material	Housing	Polymer		
	Cable sheath	Polyurethane		

Dimensions

Download CAD data → www.festo.com/en/engineering

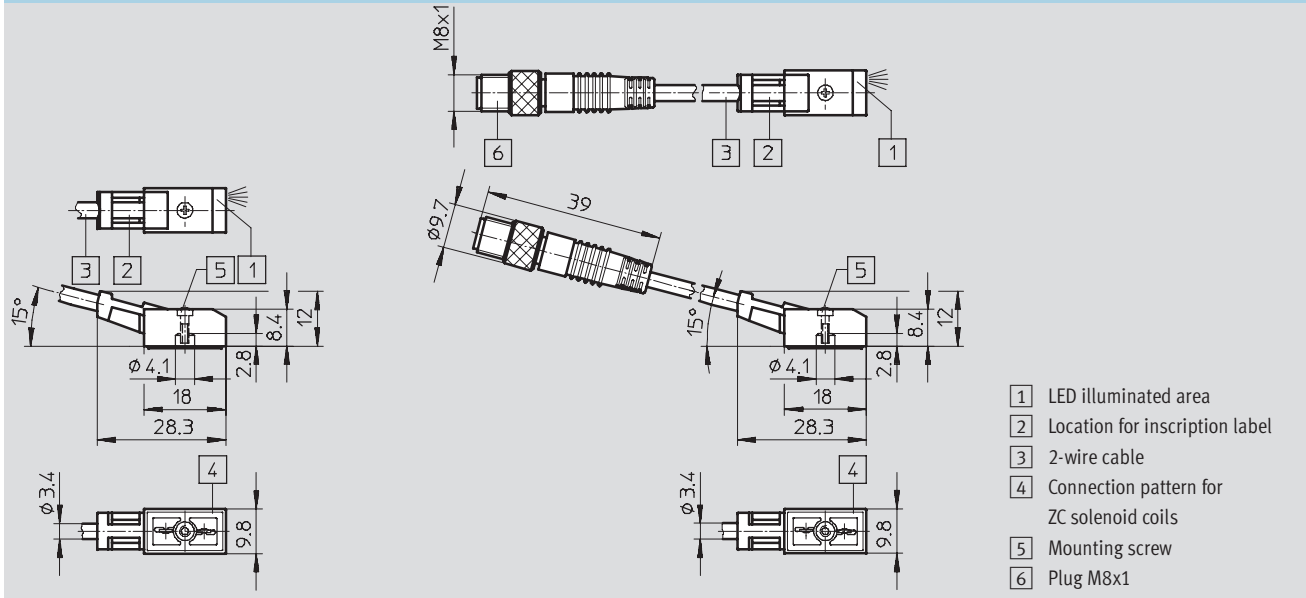

Ordering data

	Description	Operating voltage	Electrical connection	Switching status display with LED	Cable length [m]	Part No.	Type
	Plug socket with cable for fast-switching valves MH2/MH3 with metric ZC solenoid coils	24 V DC	Cable	■	2.5	193 693	KMYZ-3-24-2,5-LED-PUR-B
					5	193 695	KMYZ-3-24-5-LED-PUR-B
					10	196 066	KMYZ-3-24-10-LED-PUR-B
		Plug M8x1	■	0,5	525 654	KMYZ-3-24-M8-0,5-LED-PUR	
				2,5	525 655	KMYZ-3-24-M8-2,5-LED-PUR	

Plug sockets with cable KMYZ-4

Technical data



Temperature range
-10 ... +50 °C

- For valves with ZB and ZC solenoid coils
- Variant KMYZ-4-...-B for fast-switching valves MH2/MH3
- Variant KMYZ-4-...-B-EX for use with intrinsically safe CPV valve terminals

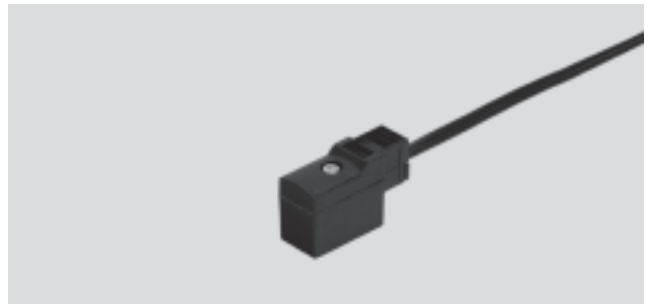

General technical data			
Type	KMYZ-4-...-B	KMYZ-4	KMYZ-4-...-B-EX
Electrical connection	Angled socket, square design MSZB		
Cable design	[mm ²]	2x0.35	
Number of pins	2		
Type of mounting	Central screw M2	Self-tapping central screw	
Protection class to EN 60529	IP40 (assembled)		
Operating voltage range	[V DC]	3 ... 36	
Nominal operating voltage	[V DC]	24	
Mounting position	Any		
Ambient temperature	[°C]	-10 ... +50	
Material	Housing	Polyamide	
	Cable sheath	Polyvinyl chloride	
Note on material	Conforms to RoHS		
Corrosion resistance class CRC ¹⁾	1		
Certification	-		Germanischer Lloyd

1) Corrosion resistance class 1 to Festo standard 940 070
Components requiring low corrosion resistance. Transport and storage protection. Parts that do not have primarily decorative surface requirements, e.g. in internal areas that are not visible or behind covers.

Valve accessories
Cables with sockets

7.3

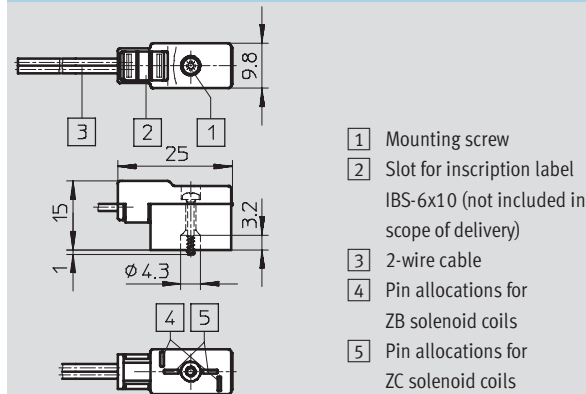

Dimensions Download CAD data → www.festo.com/en/engineering



Plug sockets with cable KMYZ-4

Technical data

FESTO

Ordering data					
	Description	Product weight [g]	Cable length [m]	Part No.	Type
With central screw M2					
	Plug socket with cable for valves with ZB and ZC solenoid coils	10	0.5	193 690	KMYZ-4-24-0,5-B
		33	2.5	193 691	KMYZ-4-24-2,5-B
With self-tapping central screw					
	Plug socket with cable for valves with ZB and ZC solenoid coils	10	0.5	185 519	KMYZ-4-24-0,5
		33	2.5	185 520	KMYZ-4-24-2,5
With self-tapping central screw for use with intrinsically safe CPV valve terminals					
	Plug socket with cable for CPV valves	12	0.5	550 324	KMYZ-4-0.5-B-EX
		34.5	2.5	550 481	KMYZ-4-2.5-B-EX
		62.5	5	550 482	KMYZ-4-5.0-B-EX

-  - Type discontinued
Available up until 2006

FESTO

Plug sockets with cable KMYZ-6

Technical data

-  - Temperature range
-10 ... +50°C

• For valves with ZB solenoid coils



General technical data				
Cable length	[m]	2.5	5	10
Wire cross section	[mm ²]	2x0.25		
Number of pins		3		
Switching status display		LED		
Type of mounting		Self-tapping central screw		
Protection class to EN 60 529		IP65 (assembled)		
Mounting position		Any		
Coil management at 24 V DC		24 mA in 23 ms		
CE symbol		89/336/EEC (EMC)		
Ambient temperature	[°C]	-10 ... +50		
Product weight	[g]	44	81	154
Material	Housing	Polymer		
	Cable sheath	Polyurethane		

Valve accessories
Cables with sockets

7.3

Dimensions

Download CAD data → www.festo.com/en/engineering

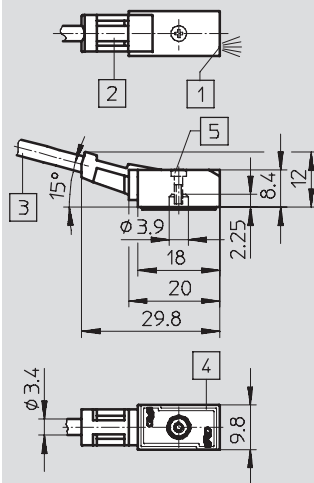

- 1 LED illuminated area
- 2 Location for inscription label
- 3 2-wire cable
- 4 Connection pattern for ZB solenoid coils
- 5 Mounting screw

Ordering data

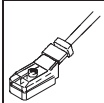
	Description	Operating voltage	Switching status display with LED	Cable length [m]	Part No.	Type
	Plug socket with cable for valves with ZB solenoid coils	24 V DC	■	2.5	193 679	KMYZ-6-24-2,5-LED-PUR
				5	193 681	KMYZ-6-24-5-LED-PUR
				10	196 068	KMYZ-6-24-10-LED-PUR

Plug sockets with cable KMYZ-9



Technical data

Temperature range
-10 ... +50°C

For valves with ZC solenoid coils
(CPE10/CPE14)



General technical data			
Wire cross section	[mm ²]	2x0.25	
Number of pins		2	
Switching status display		LED	
Type of mounting		M2 central screw	
Protection class to EN 60 529		IP65 (assembled)	
Mounting position		Any	
CE symbol		89/336/EEC (EMC)	
Coil management at 24 V DC		23 mA in 24 ms	
Ambient temperature	[°C]	-10 ... +50	
Product weight	[g]	46	82
Material	Housing	Polymer	
	Cable sheath	Polyurethane	

Dimensions

Download CAD data → www.festo.com/en/engineering

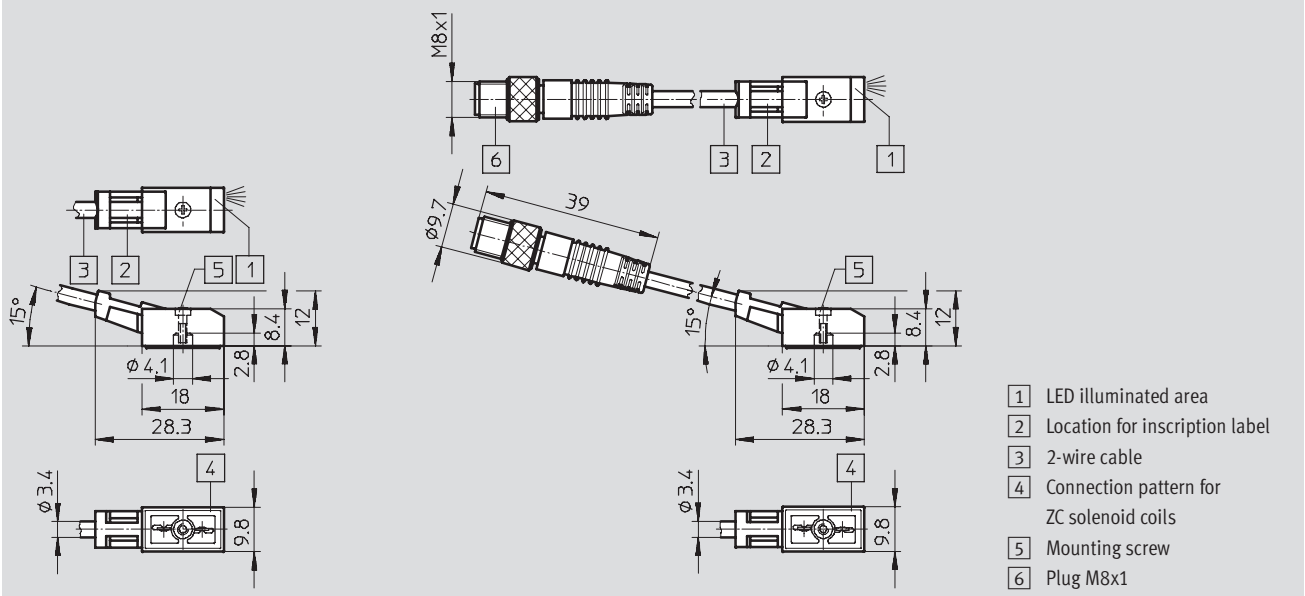

Ordering data							
	Description	Operating voltage	Electrical connection	Switching status display with LED	Cable length [m]	Part No.	Type
	Plug socket with cable for valves with ZC solenoid coils	24 V DC	Cable	■	2.5	193 687	KMYZ-9-24-2,5-LED-PUR-B
					5	193 689	KMYZ-9-24-5-LED-PUR-B
					10	196 063	KMYZ-9-24-10-LED-PUR-B
			Plug M8x1	■	0,5	196 064	KMYZ-9-24-M8-0,5-LED-PUR-B
					2,5	196 065	KMYZ-9-24-M8-2,5-LED-PUR-B

Plug sockets with cable KMH

Technical data



Temperature range
-40 ... +80°C

- For miniature valves MHA1 and MHP1
- For fast-switching valves MHA2 and MHP2



General technical data					
Cable length	[m]	0.5	1	2.5	5
Number of pins		2			
Type of mounting		Clip			
Protection class to EN 60 529		IP40 (assembled)			
Mounting position		Any			
Ambient temperature	[°C]	-40 ... +80			
Product weight	[g]	4	7	17	31
Material	Housing	Polyacetal			
	Cable sheath	Polyvinyl chloride			

Dimensions Download CAD data → www.festo.com/en/engineering

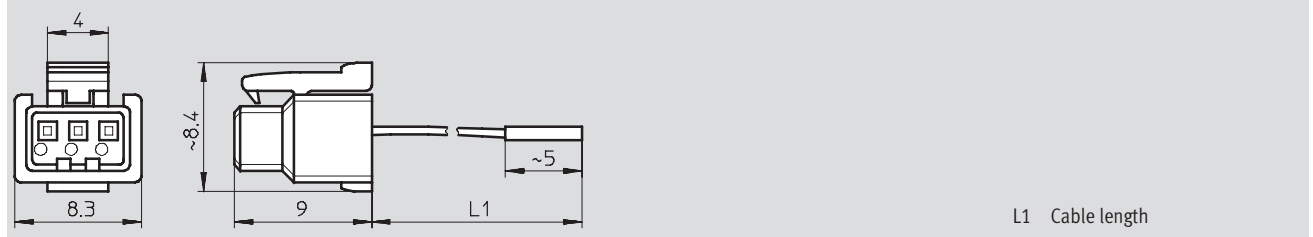

Ordering data					
	Description	Operating voltage	Cable length [m]	Part No.	Type
	Plug socket with cable for miniature valves MHA1 and MHP1 and fast-switching valves MHA2 and MHP2	24 V DC	0.5	197 263	KMH-0,5
			1	197 264	KMH-1
			2.5	527 400	KMH-2,5
			5	527 401	KMH-5

Valve accessories
Cables with sockets

7.3

Plug sockets with cable NEBV

Technical data

 Temperature range
-20 ... +70°C

• For miniature valves MHA1 and MHP1

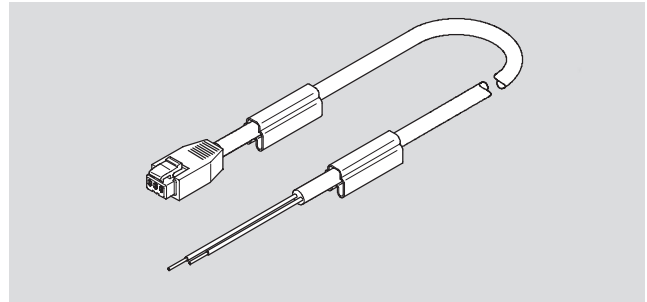

General technical data		NEBV-H1G2-P-...	NEBV-H1G2L-P-...
Electrical connection		Socket, 2-pin	
Output current	[A]	2	
Protection class to EN 60 529		IP40 (assembled)	
Operating voltage	[V AC]	0 ... 30	4.5 ... 26.4
	[V DC]	0 ... 30	4.5 ... 26.4
Corrosion resistance class CRC		4 ¹⁾	
Ambient temperature	[°C]	-20 ... +70	
Material	Housing	Polyacetal	
	Cable sheath	Polyvinyl chloride	

1) CRC4: Corrosion resistance class to Festo standard 940 070

Components with very heavy corrosion exposure. Components in contact with aggressive media, e.g. in food or chemical industries. These applications must, if necessary, be verified by special tests with the media concerned.

Dimensions

Download CAD data → www.festo.com/en/engineering

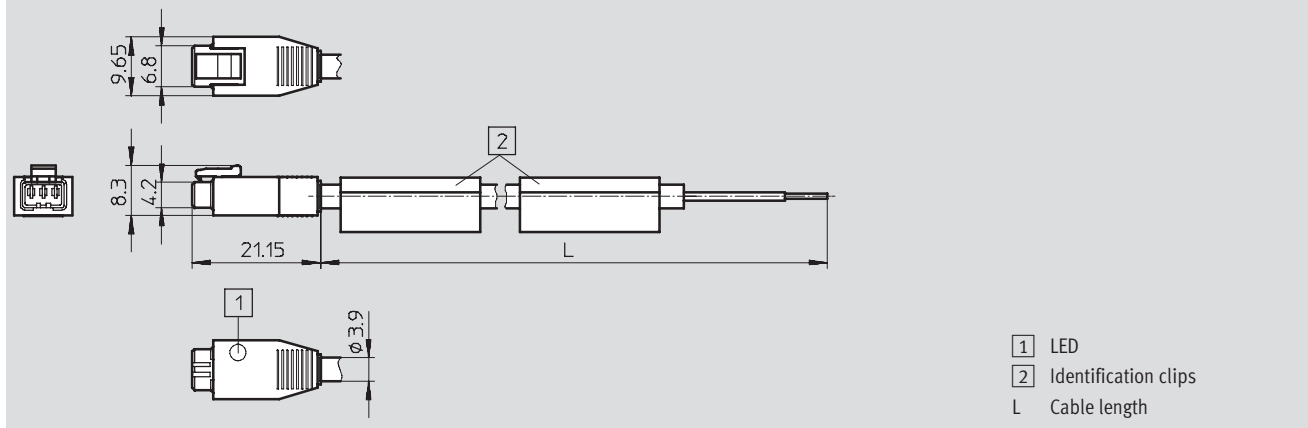

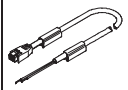
Ordering data						
	Description	LED	Cable length [m]	Product weight [g]	Part No.	Type
	Plug socket with cable for miniature valves MHA1 and MHP1	–	0.5	12	552 001	NEBV-H1G2-P-0.5-LE2
		–	1	24	552 002	NEBV-H1G2-P-1-LE2
		–	2.5	60	552 003	NEBV-H1G2-P-2.5-LE2
		–	5	120	552 004	NEBV-H1G2-P-5-LE2
		■	0.5	12	554 029	NEBV-H1G2L-P-0.5-LE2
		■	1	24	554 030	NEBV-H1G2L-P-1-LE2
		■	2.5	60	554 031	NEBV-H1G2L-P-2.5-LE2
		■	5	120	554 032	NEBV-H1G2L-P-5-LE2

Plug sockets with cable KMPPE

Technical data



- - Temperature range
-30 ... +80°C

- For proportional pressure regulators MPPE and MPPEs



General technical data			
Cable length	[m]	2.5	5
Wire cross section	[mm ²]	8x0.25	
Number of pins		8	
Type of mounting		Knurled locknut M16x0.75	
Mounting position		Any	
Ambient temperature	[°C]	-30 ... +80	
Product weight	[g]	243	459
Material	Cable sheath	Polyvinyl chloride	

Dimensions Download CAD data → www.festo.com/en/engineering

1 PVC cable

Ordering data					
	Description	Operating voltage	Cable length [m]	Part No.	Type
	Plug socket with cable for proportional pressure regulators MPPE and MPPEs	24 V DC	2.5	161 879	KMPPE-B-2,5
			5	161 878	KMPPE-B-5

Plug sockets with cable KM12

Technical data

Temperature range
-30 ... +70°C

- For valves to ISO 15 407-1 (VDMA 24 563) and ISO 5599-1 with central plug M12x1



General technical data		
Wire cross section	[mm ²]	4x0.34
Number of pins		4
Cable length	[m]	1
Type of mounting		Knurled locknut M12x1
Protection class to EN 60 529		IP67 (assembled)
Mounting position		Any
Operating voltage range	[V AC]	Max. 60
Operating voltage range	[V DC]	Max. 75
Ambient temperature	Fixed cable installation	[°C] -30 ... +70
	Flexible cable installation	[°C] -5 ... +70
Product weight	[g]	66
Material	Housing	Polyurethane
	Cable sheath	Polyurethane

Dimensions

Download CAD data → www.festo.com/en/engineering

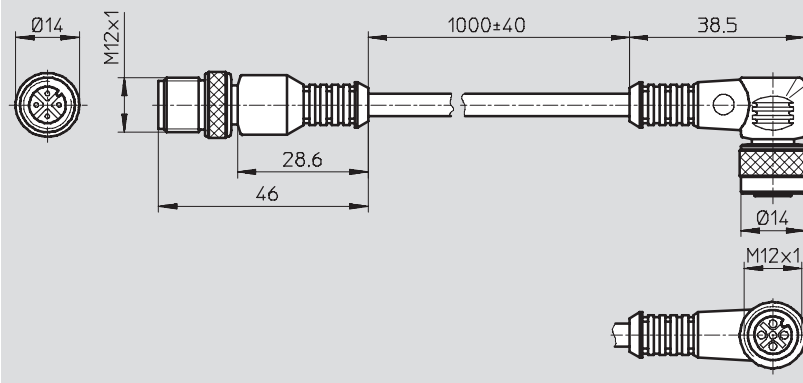

Ordering data				
	Description	Cable length [m]	Part No.	Type
	Plug socket with cable for valves to ISO 15 407-1 (VDMA 24 563) and ISO 5599-1 with central plug M12x1	1	185 499	KM12-M12-GSWD-1-4

Plug sockets with cable NEBU

Technical data



• Temperature range
-25 ... +90 °C

• For proportional valves from the
VPPM series



General technical data		
Electrical connection		Angled socket, 8-pin, M12x1
Cable design	[mm ²]	8x0.25, screened
Current-carrying capacity	[A]	1.5
Protection class to EN 60529		IP67 (assembled)
Minimum cable bending radius	[mm]	66
Operating voltage range	[V AC]	0 ... 30
	[V DC]	0 ... 36
Corrosion resistance class CRC ¹⁾		2
Ambient temperature	[°C]	-25 ... +90
Material	Housing	Polyurethane
	Cable sheath	Polyurethane
	Wire ends	Tin-plated

1) Corrosion resistance class 2 to Festo standard 940 070

Components subject to moderate corrosion stress. Externally visible parts with primarily decorative surface requirements which are in direct contact with a normal industrial environment or media such as coolants or lubricating agents.

Dimensions Download CAD data → www.festo.com/en/engineering

Ordering data					
	Description	Product weight [g]	Cable length [m]	Part No.	Type
	Plug socket with cable for proportional valves	140	2	542 256	NEBU-M12W8-2-N-LE8
		320	5	542 257	NEBU-M12W8-5-N-LE8