

## Pressure sensors SDE1, with display

**FESTO**



# Pressure sensors SDE1, with display

Product range overview

Method of measurement	Operating voltage [V DC]	Measured variable	Pressure measuring range [bar]	Pneumatic connection	Type of mounting	Electrical output	
						Digital	Analogue
Piezoresistive pressure sensor with display	15 ... 30	Relative pressure Differential and relative pressure	-1 ... 0, -1 ... +1, 0 ... 2, 0 ... 6, 0 ... 10	Male thread R1/8, R1/4 Female thread G1/8 Push-in fitting for tubing O.D. 4 mm	On service unit, via H-rail, via wall/surface bracket, front panel mounting	PNP	-
						2x PNP	-
						PNP	0 ... 10 V
						PNP	4 ... 20 mA
						2x PNP	4 ... 20 mA
						NPN	-
						2x NPN	-
						NPN	0 ... 10 V
NPN	4 ... 20 mA						

## Variants

- LCD display with backlighting (optimised operation)
- Illuminated LCD display (optimised reading)
- Electrical output PNP, 2x PNP, NPN, 2x NPN, 0 ... 10 V analogue, 4 ... 20 mA analogue and combinations thereof
- Electrical connection with plug M8x1 or M12x1
- Connecting cable

# Pressure sensors SDE1, with display

Peripherals overview

FESTO

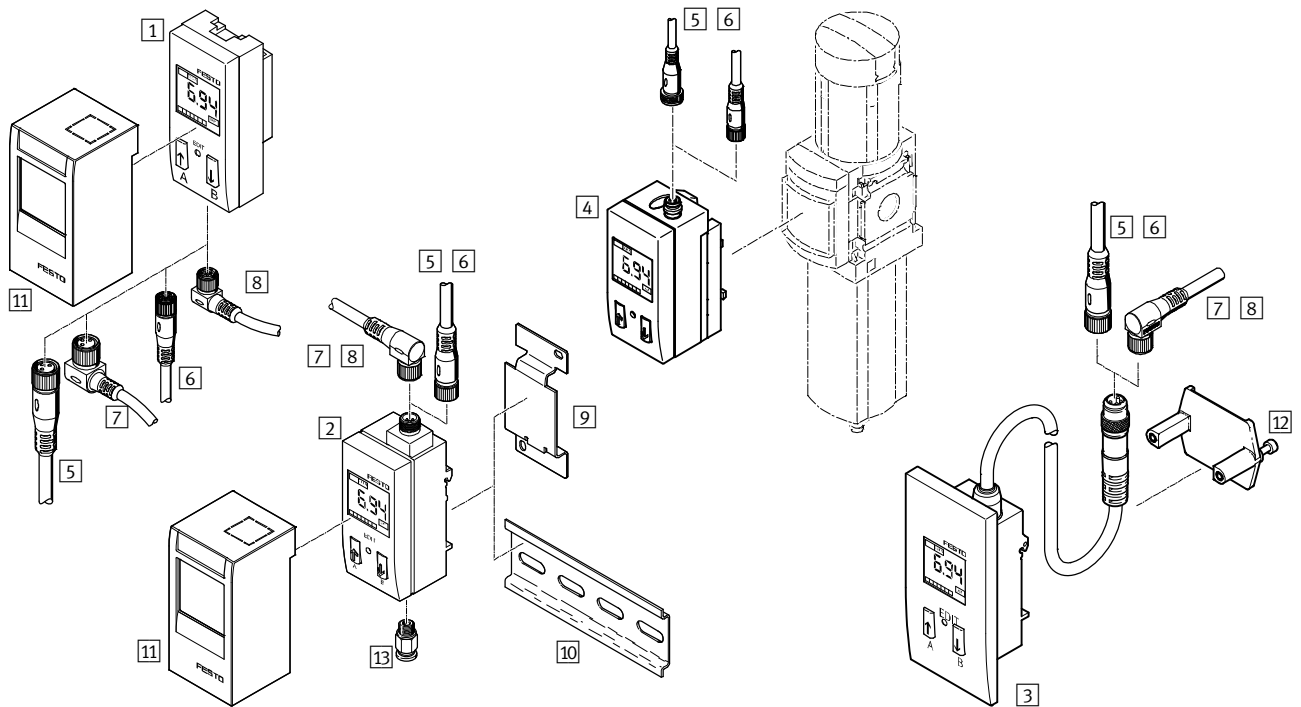

Mounting attachments and accessories	→ Page/Internet
1 Pressure sensor SDE1-...-R18, SDE1-...-R14	5
2 Pressure sensor SDE1-...-H18, SDE1-...-W18	5
3 Pressure sensor SDE1-...-FQ4	5
4 Pressure sensor SDE1-...-MS...	5
5 Connecting cable NEBU-M12G...	14
6 Connecting cable, straight socket NEBU-M8G...	14
7 Connecting cable, angled socket NEBU-M12W...	14

Mounting attachments and accessories	→ Page/Internet
8 Connecting cable NEBU-M8W... with angled socket	14
9 Adapter plate SDE1-...-W-...	14
10 Mounting rail to DIN EN 60715	nrh
11 Protective cover SDE1-SH	14
12 Clamping plate (included in the scope of delivery with SDE1-...-FQ4)	-
13 Push-in fitting QS-1/8	14

# Pressure sensors SDE1, with display

Type codes

SDE1 - D10 - G2 - W18 - L - P1 - M12 - G5

## Function

SDE1	Pressure sensor with display
------	------------------------------

## Pressure measuring range

V1	-1 ... 0 bar
B2	-1 ... +1 bar
D2	0 ... 2 bar
D6	0 ... 6 bar
D10	0 ... 10 bar

## Absolute accuracy

G2	Accuracy 2%
----	-------------

## Pneumatic connection and mounting

Measured variable: relative pressure

R18	Male thread R1/8, mounting on service unit
R14	Male thread R1/4, mounting on service unit
MS4	Direct connection to MS4 series service units
MS6	Direct connection to MS6 series service units
H18	Female thread G1/8, H-rail mounting
W18	Female thread G1/8, wall or surface mounting

Measured variable: differential pressure and relative pressure

FQ4	Push-in connector QS-4, front panel mounting
HQ4	Push-in connector QS-4, DIN H-rail mounting
WQ4	Push-in connector QS-4, wall or surface mounting

## Display and setting

C	LCD display with backlighting (optimised operation)
L	Illuminated LCD display (optimised reading)

## Electrical output

P1	1 switching output PNP
P2	2 switching outputs PNP
PU	1 switching output PNP and 0 ... 10 V analogue
PI	1 switching output PNP and 4 ... 20 mA analogue
2I	2 switching outputs PNP and 4 ... 20 mA analogue
N1	1 switching output NPN
N2	2 switching outputs NPN
NU	1 switching output NPN and 0 ... 10 V analogue
NI	1 switching output NPN and 4 ... 20 mA analogue

## Electrical connection

M8	Plug M8x1
M12	Plug M12x1

## Electric accessories

Connecting cable, straight plug socket	
G	2.5 m long
G5	5 m long
Connecting cable, angled plug socket	
W	2.5 m long
W5	5 m long

# Pressure sensors SDE1, with display

Technical data

Function<sup>1)</sup>

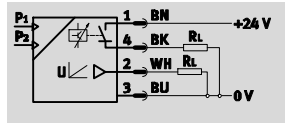

1) e.g. with 1 switching output PNP and 0 ... 10 V analogue

Voltage  
15 ... 30 V DC

Pressure  
-1 ... +10 bar

Temperature range  
0 ... 50 °C

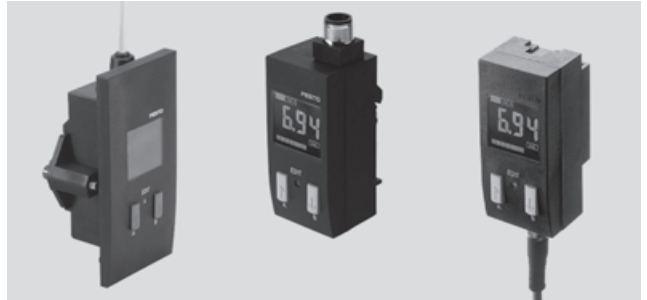

General technical data					
SDE1-...	-R...	-MS...	-H...	-W...	-F...
Certification	cULus recognized (OL) RCM trademark				-
CE mark (see declaration of conformity) <sup>1)</sup>	To EU EMC Directive				
Note on materials	Free of copper and PTFE RoHS-compliant				

1) For information about the applicability of the component see the manufacturer's EC declaration of conformity at: [www.festo.com/sp](http://www.festo.com/sp) → User documentation.  
If the component is subject to restrictions on usage in residential, office or commercial environments or small businesses, further measures to reduce the emitted interference may be necessary.

Input signal/measuring element					
SDE1	-B2	-V1	-D2	-D6	-D10
Measured variable	Relative pressure Differential pressure <sup>2)</sup>				
Method of measurement	Piezoresistive pressure sensor with display				
Operating medium	Compressed air in accordance with ISO 8573-1:2010 [7:4:4]				
Note on operating/pilot medium	Operation with lubricated medium possible (in which case lubricated operation will always be required)				
Pressure measuring range [bar]	-1 ... +1	0 ... -1	0 ... 2	0 ... 6	0 ... 10
Temperature of medium [°C]	0 ... 50				
Ambient temperature [°C]	0 ... 50				

2) Versions with push-in connector QS-4

Output, general		
Accuracy FS <sup>3)</sup>	[%]	2

3) % FS = % of the measuring range (full scale)

Switching output		
Switching output		PNP NPN
Switching function		Freely programmable
Switching element function		Switchable
Reproducibility of switching value [%]		0.3
Max. output current [mA]		150

Analogue output		
Analogue output	[V]	0 ... 10
	[mA]	4 ... 20

Output, additional data	
Protection against short circuit	Pulsed

# Pressure sensors SDE1, with display

Technical data

Electronic components		
Operating voltage range DC	[V]	15 ... 30
Reverse polarity protection		For all electrical connections

Electromechanical components		
SDE1-...	-M8	-M12
Electrical connection	Plug M8x1, 3-pin	Plug M12x1, 3-pin
	Plug M8x1, 4-pin	Plug M12x1, 4-pin
	–	Plug M12x1, 5-pin
	Round design	
	To EN 60947-5-2	

Mechanical components	
Type of mounting	Via H-rail
	Via wall/surface bracket
	On service unit
	Front panel mounting
Pneumatic connection	R1/8
	R1/4
	G1/8
	QS-4
Housing materials	PA, POM-reinforced

• Note: This product conforms to ISO 1179-1 and to ISO 228-1

Display/operation	
Display type	Back illuminated LCD
	Illuminated LCD
Setting options	Teach-in
Threshold value setting range	[%] 2 ... 99.8
Hysteresis setting range	[%] 0 ... 90

Immissions/emissions	
Protection class	IP65
Corrosion resistance class CRC <sup>4)</sup>	2

4) Corrosion resistance class 2 according to Festo standard 940 070  
Components subject to moderate corrosion stress. Externally visible parts with primarily decorative surface requirements which are in direct contact with a normal industrial environment or media such as coolants or lubricating agents.

# Pressure sensors SDE1, with display

Technical data

Electrical outputs <sup>1)</sup>		Pin allocations	
<b>1 switching output PNP</b>			
Variant P1 with plug M8		1 = +24 V 3 = 0 V 4 = Output A	
Variant P1 with plug M12		1 = +24 V 3 = 0 V 4 = Output A	
<b>2 switching outputs PNP</b>			
Variant P2 with plug M8		1 = +24 V 2 = Output B 3 = 0 V 4 = Output A	
Variant P2 with plug M12		1 = +24 V 2 = Output A 3 = 0 V 4 = Output B	
<b>1 switching output PNP and 0 ... 10 V analogue</b>			
Variant PU with plug M8		1 = +24 V 2 = Output B (0 ... 10 V analogue) 3 = 0 V 4 = Output A	
Variant PU with plug M12		1 = +24 V 2 = Output A 3 = 0 V 4 = Output B (0 ... 10 V analogue)	
<b>1 switching output PNP and 4 ... 20 mA analogue</b>			
Variant PI with plug M8		1 = +24 V 2 = Output B (4 ... 20 mA analogue) 3 = 0 V 4 = Output A	
Variant PI with plug M12		1 = +24 V 2 = Output A 3 = 0 V 4 = Output B (4 ... 20 mA analogue)	
<b>2 switching outputs PNP and 4 ... 20 mA analogue</b>			
Variant 2I with plug M12		1 = +24 V 2 = Output B 3 = 0 V 4 = Output A 5 = Output C (4 ... 20 mA analogue)	

1) Core colours indicated apply when using connecting cable NEBU.

# Pressure sensors SDE1, with display

Technical data

Electrical outputs <sup>1)</sup>	Pin allocations	
<b>1 switching output NPN</b>		
Variant N1 with plug M8		<p>1 = +24 V 3 = 0 V 4 = Output A</p>
Variant N1 with plug M12		<p>1 = +24 V 3 = 0 V 4 = Output A</p>
<b>2 switching outputs NPN</b>		
Variant N2 with plug M8		<p>1 = +24 V 2 = Output B 3 = 0 V 4 = Output A</p>
Variant N2 with plug M12		<p>1 = +24 V 2 = Output A 3 = 0 V 4 = Output B</p>
<b>1 switching output NPN and 0 ... 10 V analogue</b>		
Variant NU with plug M8		<p>1 = +24 V 2 = Output B (0 ... 10 V analogue) 3 = 0 V 4 = Output A</p>
Variant NU with plug M12		<p>1 = +24 V 2 = Output A 3 = 0 V 4 = Output B (0 ... 10 V analogue)</p>
<b>1 switching output NPN and 4 ... 20 mA analogue</b>		
Variant NI with plug M8		<p>1 = +24 V 2 = Output B (4 ... 20 mA analogue) 3 = 0 V 4 = Output A</p>
Variant NI with plug M12		<p>1 = +24 V 2 = Output A 3 = 0 V 4 = Output B (4 ... 20 mA analogue)</p>

1) Core colours indicated apply when using connecting cable NEBU.



# Pressure sensors SDE1, with display

Technical data

## Dimensions – Mounting via male thread R1/8 or R1/4

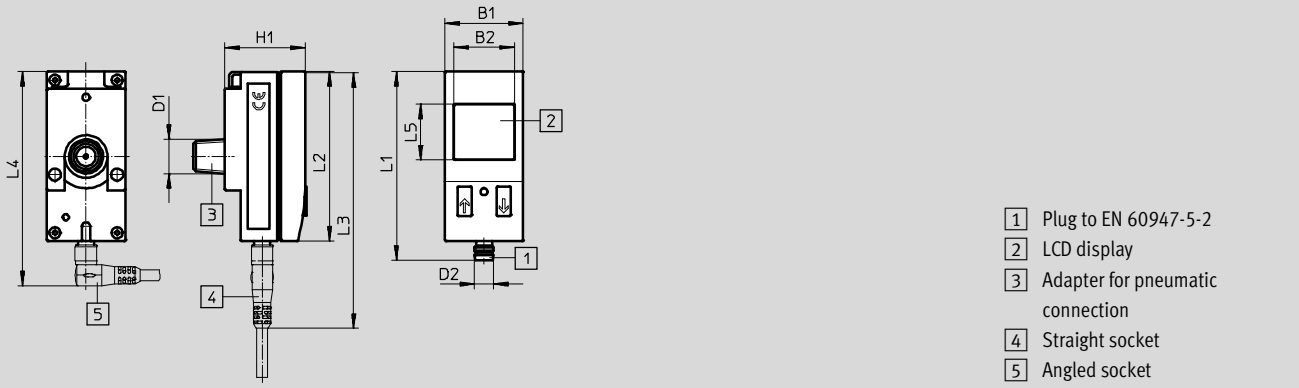

Type	B1	B2	D1	D2	H1	L1	L2	L3	L4	L5
SDE1-...-R18-M8	32.3	25	R1/8	M8	33	78	70	107	89	23
SDE1-...-R14-M8			R1/4							
SDE1-...-R18-M12	32.3	25	R1/8	M12	33	87	70	125	103	23
SDE1-...-R14-M12			R1/4							

## Dimensions – Direct connection to MS4/6 series service units

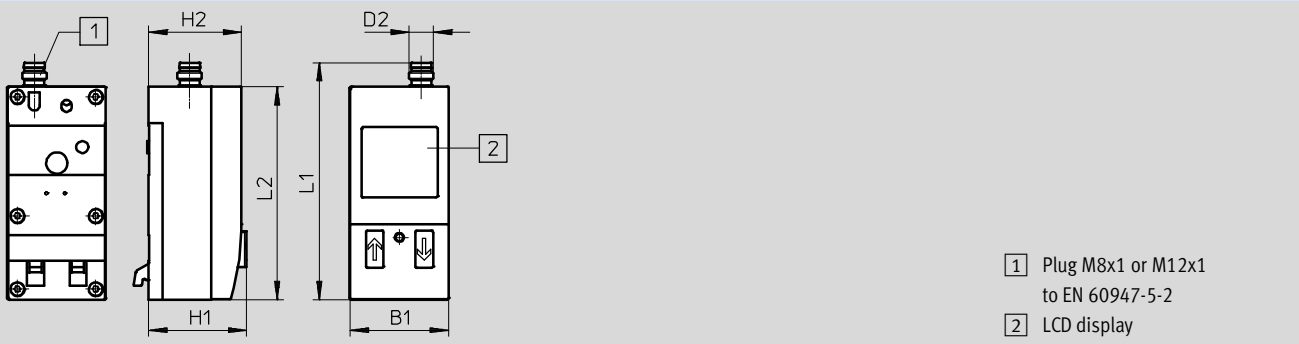

Type	B1	D2	H1	H2	L1	L2
SDE1-...-MS-...-M8	32.3	M8	32.1	30.4	78	70
SDE1-...-MS-...-M12		M12		32.3		

# Pressure sensors SDE1, with display

Technical data

## Dimensions – H-rail, wall or surface mounting

Pneumatic connection G1/8

Pneumatic connection QS-4

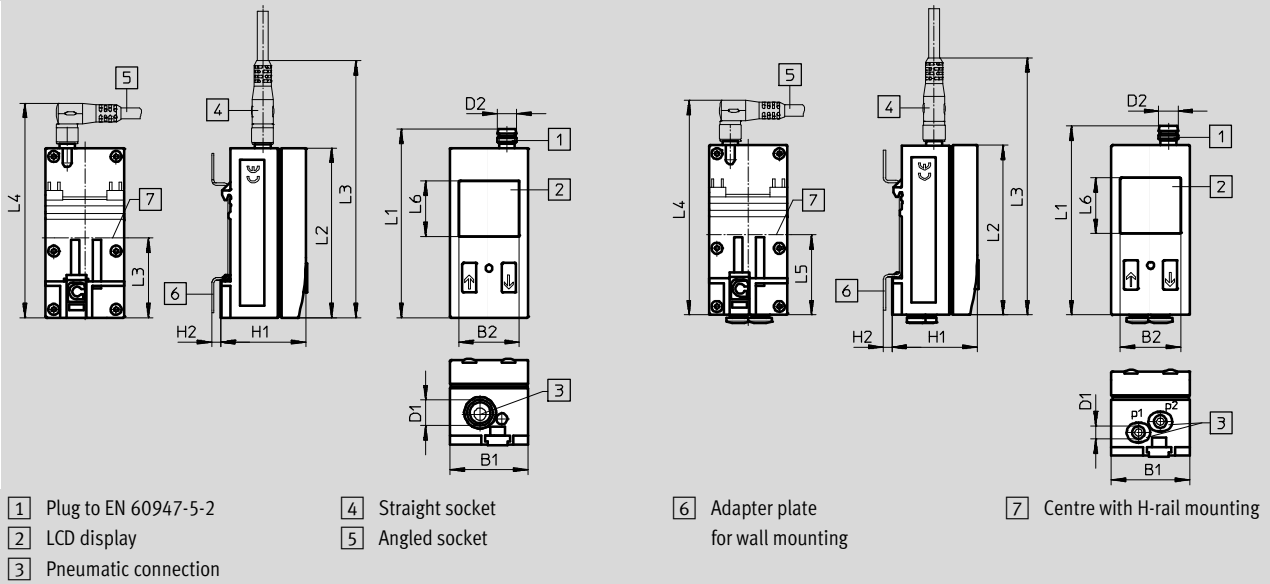

Type	B1	B2	D1	D2	H1	H2	L1	L2	L3	L4	L5	L6
SDE1...-H18...-M8	32.3	25	G1/8	M8	35.2	3.6	78	70	107	89	33	23
SDE1...-W18...-M8												
SDE1...-H18...-M12	32.3	25	G1/8	M12	35.2	3.6	87	70	125	103	33	23
SDE1...-W18...-M12												
SDE1...-HQ4...-M8	32.3	25	QS-4	M8	35.2	3.6	78	70	107	89	33	23
SDE1...-WQ4...-M8												

## Dimensions – Panel mounting

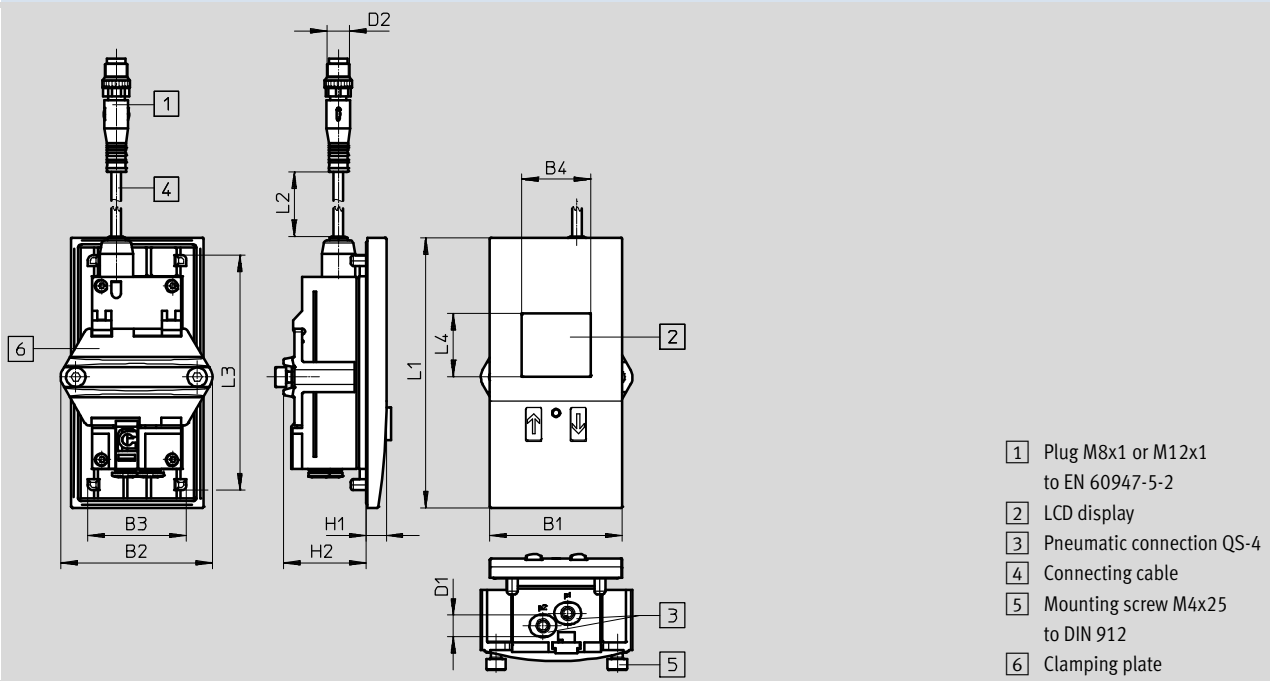

Type	B1	B2	B3	B4	D1	D2	H1	H2	L1	L2	L3	L4
SDE1...-FQ4-M8	48	55	35.8	25	QS-4	M8x1	8	30	98	320	85.3	23
SDE1...-FQ4-M12						M12x1						

# Pressure sensors SDE1, with display

Modular product system

FESTO

M Mandatory data								O Options
Module No.	Function	Pressure range	Absolute accuracy	Pneumatic connection and mounting	Display and setting	Electrical output	Electrical connection	Accessories: plug socket
192766	SDE1	B2, V1, D2, D6, D10	G2	R18, R14, MS4, MS6, H18, W18, HQ4, WQ4, FQ4	C, L	P1, P2, PU, PI, N1, N2, NU, NI	M8, M12	G, W, G5, W5
<b>Ordering example</b>								
192766	SDE1	- D6	- G2	- W18	- L	- P2	- M12	- W5

Ordering table					
			Condi- tions	Code	Enter code
M	Module No.	192766			192766
	Function	Pressure sensor		SDE1	SDE1
	Pressure range	Pressure range -1 ... 1 bar		-B2	
		Pressure range 0 ... -1 bar		-V1	
		Pressure range 0 ... 2 bar		-D2	
		Pressure range 0 ... 6 bar		-D6	
		Pressure range 0 ... 10 bar		-D10	
	Absolute accuracy	Accuracy 2%		-G2	-G2
	Pneumatic connection and mounting	Mounting R1/8 (service units)		-R18	
		Mounting R1/4 (service units)		-R14	
		Direct connection on MS4 series service units		-MS4	
		Direct connection on MS6 series service units		-MS6	
		Relative pressure with G1/8 connection for H-rail mounting		-H18	
		Relative pressure with G1/8 connection for wall/surface mounting		-W18	
		H-rail mounting, 4 mm push-in connector		-HQ4	
		Wall mounting, 4 mm push-in connector		-WQ4	
		Front panel mounting, 4 mm push-in connector		-FQ4	
	Display and setting	LCD display (optimised operation)		-C	
		Illuminated LCD (optimised reading)		-L	
	Electrical output	1 switch (PNP)		-P1	
		2 switches (PNP)		-P2	
		1 switch (PNP) and 0 ... 10 V analogue		-PU	
		1 switch (PNP) and 4 ... 20 mA analogue		-PI	
		1 switch (NPN)		-N1	
		2 switches (NPN)		-N2	
		1 switch (NPN) and 0 ... 10 V analogue		-NU	
		1 switch (NPN) and 4 ... 20 mA analogue		-NI	
	Electrical connection	Plug M8		-M8	
		Plug M12		-M12	
O	Accessories			-	-
	Electric accessories	Connecting cable, straight plug socket, 2.5 m		<sup>1</sup> G	
		Connecting cable, angled plug socket, 2.5 m		<sup>1</sup> W	
		Connecting cable, straight plug socket, 5 m		G5	
		Connecting cable, angled plug socket, 5 m		W5	

<sup>1</sup> G, W Not with electrical connection M12 in combination with electrical output P2, PU, PI, N2, NU, NI.



## Transfer order code



192766 SDE1 - [ ] - G2 - [ ] - [ ] - [ ] - [ ] - [ ]



# Pressure sensors SDE1, with display

Accessories



Ordering data – Connecting cables				Technical data → Internet: nebu	
	Number of wires	Cable length [m]	Part No.	Type	
<b>M8x1, straight socket</b>					
	3	2.5	541333	NEBU-M8G3-K-2.5-LE3	
		5	541334	NEBU-M8G3-K-5-LE3	
	4	2.5	541342	NEBU-M8G4-K-2.5-LE4	
		5	541343	NEBU-M8G4-K-5-LE4	
<b>M8x1, angled socket</b>					
	3	2.5	541338	NEBU-M8W3-K-2.5-LE3	
		5	541341	NEBU-M8W3-K-5-LE3	
	4	2.5	541344	NEBU-M8W4-K-2.5-LE4	
		5	541345	NEBU-M8W4-K-5-LE4	

Ordering data – Connecting cables				Technical data → Internet: nebu	
	Number of wires	Cable length [m]	Part No.	Type	
<b>M12x1, straight socket</b>					
	3	2.5	541363	NEBU-M12G5-K-2.5-LE3	
		5	541364	NEBU-M12G5-K-5-LE3	
	4	2.5	550326	NEBU-M12G5-K-2.5-LE4	
		5	541328	NEBU-M12G5-K-5-LE4	
	5	2.5	541330	NEBU-M12G5-K-2.5-LE5	
		5	541331	NEBU-M12G5-K-5-LE5	
<b>M12x1, angled socket</b>					
	3	2.5	541367	NEBU-M12W5-K-2.5-LE3	
		5	541370	NEBU-M12W5-K-5-LE3	
	4	2.5	550325	NEBU-M12W5-K-2.5-LE4	
		5	541329	NEBU-M12W5-K-5-LE4	

Ordering data – Accessories		
	Part No.	Type
<b>Adapter plate</b>		
	194297	SDE1-...-W-...
<b>Protective cover</b>		
	537074	SDE1-SH

Ordering data – Push-in fittings				Technical data → Internet: qs	
	For tubing O.D. [mm]	Part No.	Type		
	4	186095	QS-G1/8-4		
	6	186096	QS-G1/8-6		
	8	186098	QS-G1/8-8		

# Festo - Your Partner in Automation



**1 Festo Inc.**  
5300 Explorer Drive  
Mississauga, ON L4W 5G4  
Canada

**Festo Customer Interaction Center**  
Tel: 1 877 463 3786  
Fax: 1 877 393 3786  
Email: [customer.service.ca@festo.com](mailto:customer.service.ca@festo.com)



**2 Festo Pneumatic**  
Av. Ceylán 3,  
Col. Tequesquináhuac  
54020 Tlalnepantla,  
Estado de México

**Multinational Contact Center**  
01 800 337 8669  
[ventas.mexico@festo.com](mailto:ventas.mexico@festo.com)



**3 Festo Corporation**  
1377 Motor Parkway  
Suite 310  
Islandia, NY 11749

**Festo Customer Interaction Center**  
1 800 993 3786  
1 800 963 3786  
[customer.service.us@festo.com](mailto:customer.service.us@festo.com)



**4 Regional Service Center**  
7777 Columbia Road  
Mason, OH 45040

Connect with us



[www.festo.com/socialmedia](http://www.festo.com/socialmedia)



[www.festo.com](http://www.festo.com)

Subject to change