

Connecting cables, universal

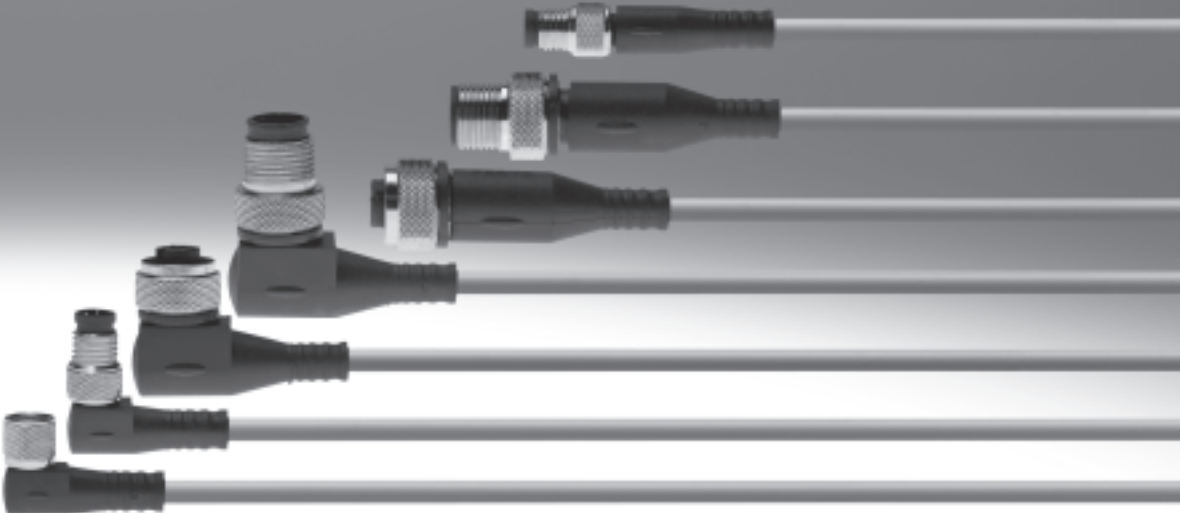

Connecting cables, universal

Key features

FESTO

Cable attributes

The connecting cables NEBU can be configured using the modular system. You can choose from attributes that

are suited to basic, standard, energy chain or robot applications.

Basic application

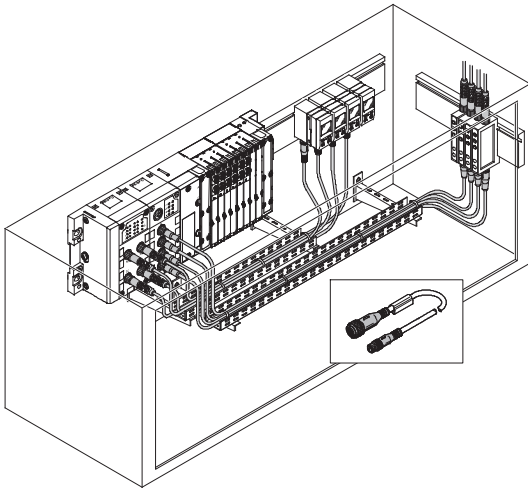

Basic applications are characterised by fixed cable installation with no mechanical loads.

Standard application

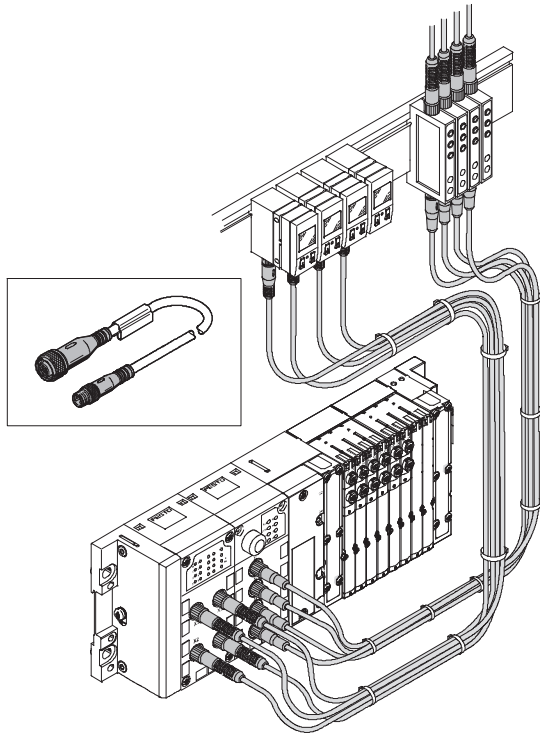

Standard applications are characterised by fixed cable

installation or small to medium mechanical loads.

Energy chain application

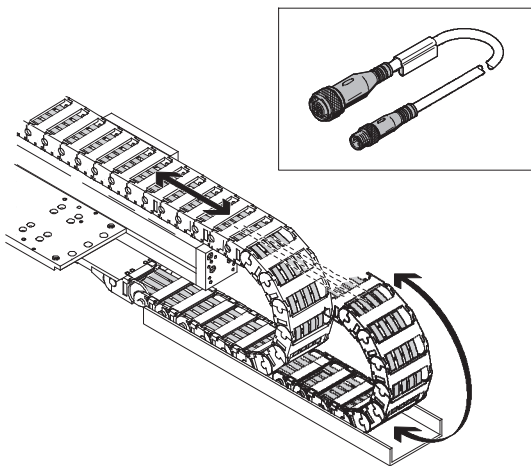

Energy chain applications involve high mechanical loads, particularly if very small radii are required.

Robot application

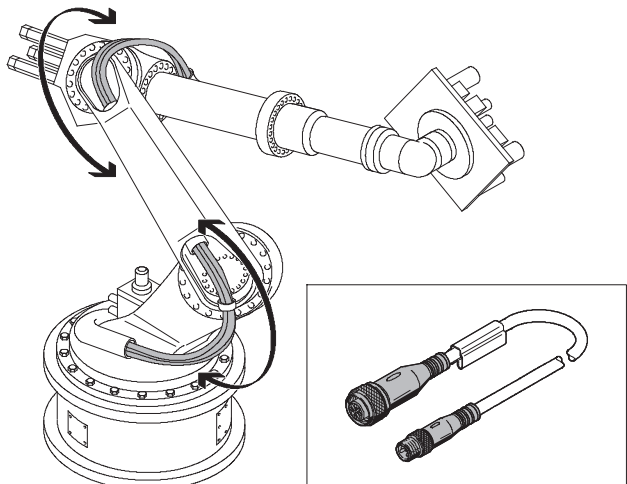

Robot applications involve high mechanical loads that are primarily caused by torsion.

Connecting cables, universal

Product range overview

FESTO

Type	Electrical connection		Number of wires	Cable length [m]	→ Page/ Internet
	Left-hand end	Right-hand end			
Cable property: Basic					
NEBU-LE	Open end	Plug M8x1	3, 4, 5	0.1 ... 30	12
		Plug M12x1			
NEBU-M8	Socket M8x1	Open end	2, 3, 4	0.1 ... 30	12
		Plug M8x1			
		Plug M12x1			
NEBU-M12	Socket M12x1	Open end	3, 4, 5	0.1 ... 30	12
		Plug M8x1			
		Plug M12x1			
Cable property: Standard					
NEBU-LE	Open end	Plug M8x1	3, 4, 5	0.1 ... 30	12
		Plug M12x1			
NEBU-M5	Socket M5x0.5	Open end	3	5	6
		Plug M8x1	3	1	
		Plug M12x1	4	1	
NEBU-M8	Socket M8x1	Open end	2, 3, 4	0.1 ... 30	12
		Plug M8x1			
		Plug M12x1			
SIM-M8	Socket M8x1	Open end	3	2.5/5/10	27
			4	2.5/5	
NEBU-M12	Socket M12x1	Open end	3, 4, 5	0.1 ... 30	12
		Plug M8x1			
		Plug M12x1			
		Open end	8	2/5	24
SIM-M12	Socket M12x1	Open end	3	2.5/5	27
			4	5	
			5	2.5/5	
			8	2/5/10	
KM12-8	Socket M12x1	Plug M12x1	8	2	33
Cable property: Suitable for use with energy chains					
NEBU-M8	Socket M8x1	Open end	3, 4	0.1 ... 30	12
		Plug M8x1			
		Plug M12x1			
NEBU-M12	Socket M12x1	Open end	3, 4, 5	0.1 ... 30	12
		Plug M8x1			
		Plug M12x1			
Cable property: Suitable for robots					
NEBU-M8	Socket M8x1	Open end	3, 4	0.1 ... 30	12
		Plug M8x1			
		Plug M12x1			
NEBU-M12	Socket M12x1	Open end	3, 4, 5	0.1 ... 30	12
		Plug M8x1			
		Plug M12x1			

Connecting cables, universal

Product range overview



Type	Electrical connection		Number of wires	Cable length [m]	→ Page/ Internet
	Left-hand end	Right-hand end			
With switching status display					
NEBU-M8	Socket M8x1	Open end	3	0.1 ... 30	12
		Plug M8x1			
		Plug M12x1			
SIM-M8	Socket M8x1	Open end	3	2.5/5	27
Welding field immune					
NEBU-M12	Socket M12x1	Open end	3	0.1 ... 30	12
		Plug M8x1			
		Plug M12x1			
SIM-M12	Socket M12x1	Open end	3	2.5/5	27
Clip-on					
SIM-K	Clip-on socket	Open end	3	2.5/5/10	37
			4	2.5/5	
Clean Design					
SIM-K-CDN	Clip-on socket	Open end	3	2.5/5	39

Connecting cables NEBU-M5

Type codes

NEBU - M5 G 4 - K - 1 - Q3 - M8 G 3

Function

NEBU Connecting cable

Connection technology, left-hand end

M5 Socket with connecting thread

Socket design

G Straight

Number of pins/wires (left-hand end)

4 4-pin

Cable property

K Standard

Cable length

1 1 m

5 5 m

Alternative wire cross section

Q3 0.14 mm²

Connection technology, right-hand end

Cable length 5 m

LE Open end

Cable length 1 m

M8 Plug with connecting thread

M12 Plug with connecting thread,
A-coded

Plug design

Open end

G Straight

Number of pins/wires (right-hand end)

Connection technology, right-hand end, LE or M8

3 3-pin

Connection technology, right-hand end, M12

4 4-pin

Connecting cables NEBU-M5

Technical data

FESTO

Connecting cable NEBU-M5

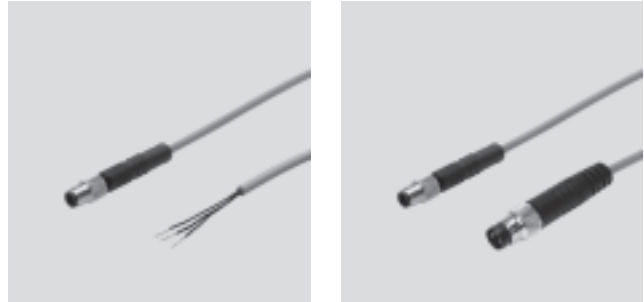

Electronic components		
Operating voltage range	[V AC]	30
Operating voltage range	[V DC]	30

Electromechanical components – Connection technology				
Type	NEBU-M5G4-K-5-Q3-LE3	NEBU-M5G4-K-1-Q3-M8G3	NEBU-M5G4-K-1-Q3-M12G4	
Connection technology, left-hand end				
Electrical connection	Straight socket			
	M5x0.5			
	4-pin			
Connection technology, right-hand end				
Electrical connection	Open end	Straight plug	Straight plug	
	–	M8x1	M12x1	
	3-wire	4-pin	4-pin	
Max. tightening torque, socket	[Nm]	0.3	0.3	0.3
Max. tightening torque, plug	[Nm]	–	0.3	0.5
Cable property	Standard		Standard	
Cable test conditions, standard	Energy chain: 5 million cycles, bending radius 75 mm			
	Resistance to bending: to Festo standard			
	Test conditions on request			
Cable length	[m]	5	1	1
Cable sheath colour	Grey		Grey	
Cable composition	3x0.14 mm ²		4x0.14 mm ²	
Cable type	LiFY11Y		LiFY11Y	
Information on cable sheath materials	TPE-U(PU)		TPE-U(PU)	
Information on pin contact materials	Gold-plated brass			
Cable diameter	[mm]	2.9	2.9	3.4
Conductor nominal cross section	[mm ²]	0.14	0.14	0.14
Wire ends	Wire end sleeve		–	
Acceptable current load	[A]	1.7	1.7	1.7

Connecting cables NEBU-M5

Technical data

Mechanical components			
Type	NEBU-M5G4-K-5-Q3-LE3	NEBU-M5G4-K-1-Q3-M8G3	NEBU-M5G4-K-1-Q3-M12G4
Min. cable bending radius [mm]	30	30	35
Type of mounting	Via knurled nut Via union nut		
Housing colour	Black		
Information on housing materials	TPE-U(PU)		
Information on union nut materials	Nickel-plated brass		

Immissions/emissions	
Protection class	IP65, IP67
Degree of contamination	3

Pin allocation		
NEBU-M5G4-K-5-Q3-LE3		
Socket M5x0.5, 4-pin	Pin	Wire colour
	1	Brown
	3	Blue
	4	Black

NEBU-M5G4-K-1-Q3-M8G3					
Socket M5x0.5, 4-pin	Pin	Wire colour	Plug M8x1, 3-pin	Pin	Wire colour
	1	Brown		1	Brown
	3	Blue		3	Blue
	4	Black		4	Black

NEBU-M5G4-K-1-Q3-M12G4					
Socket M5x0.5, 4-pin	Pin	Wire colour	Plug M12x1, 4-pin	Pin	Wire colour
	1	Brown		1	Brown
	2	White		2	White
	3	Blue		3	Blue
	4	Black		4	Black

Dimensions		Download CAD Data → www.festo.com/us/cad				
NEBU-M5G4-K-5-Q3-LE3						
<div style="border: 1px solid black; padding: 2px; display: inline-block;">1</div> Socket M5x0.5, 4-pin						

Type	D1	D2	D3	L1	L2	L3
	∅		∅	[m]		±2
NEBU-M5G4-K-5-Q3-LE3	2.9	M5x0.5	6	5	27.5	50

Connecting cables NEBU-M5

Technical data

Dimensions Download CAD Data → www.festo.com/us/cad

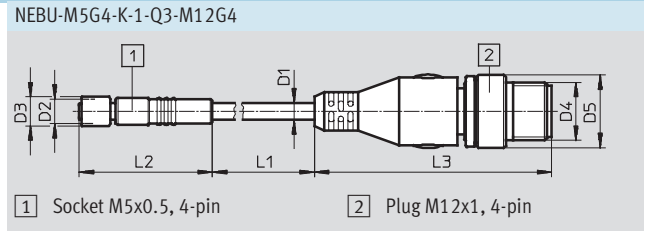
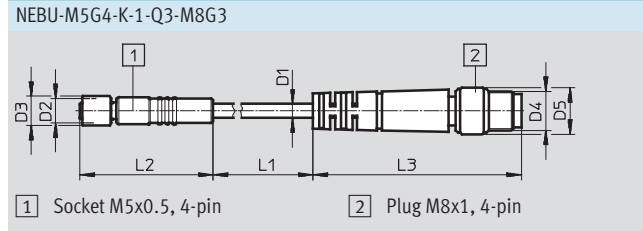

Type	D1 ∅	D2	D3 ∅	D4	D5 ∅	L1 [m]	L2	L3
NEBU-M5G4-K-1-Q3-M8G3	2.9	M5x0.5	6	M8x1	9.6	1	27.5	43
NEBU-M5G4-K-1-Q3-M12G4	3.4	M5x0.5	6	M12x1	15	1	27.5	49

Electrical connection		Number of wires	Cable length [m]	Part No.	Type
Left-hand end	Right-hand end				
Cable property: Standard					
Socket M5x0.5, straight, 4-pin	Open end, 3-wire	3	5	539508	NEBU-M5G4-K-5-Q3-LE3
	Plug M8x1, straight, 3-pin	3	1	539510	NEBU-M5G4-K-1-Q3-M8G3
	Plug M12x1, straight, 4-pin	4	1	539512	NEBU-M5G4-K-1-Q3-M12G4

Connecting cables NEBU-LE

Type codes

	NEBU	-	LE	5	-	K	-	1	-		-	M12	G	5
Function														
NEBU	Connecting cable													
Connection technology, left-hand end														
LE	Open end													
Number of pins/wires (left-hand end)														
3	3-pin													
4	4-pin													
5	5-pin													
Cable characteristics														
P	Basic													
K	Standard													
E	Suitable for use with energy chains													
R	Suitable for robot applications													
Cable length														
0.1 ... 30	0.1 ... 30 m													
Cable designation														
	With inscription label holder (standard)													
N	Without inscription label holder													
Connection technology, right-hand end														
M8	Plug with connecting thread													
M12	Plug with connecting thread, A-coded													
Plug design														
G	Straight													
W	Angled													
Number of pins/wires (right-hand end)														
3	3-pin													
4	4-pin													
5	5-pin													

Additional variants can be ordered using the modular product system → 21

- Number of pins/wires (left-hand end)
- Cable characteristics
- Cable designation
- Connection technology, right-hand end
- Plug design
- Number of pins/wires (right-hand end)

Connecting cables NEBU-M8

Type codes

NEBU - M8 G 3 - K - 2.5 - M8 G 3

Function

NEBU	Connecting cable
------	------------------

Connection technology, left-hand end

M8	Socket with connecting thread
----	-------------------------------

Socket design

G	Straight
W	Angled
R	Rotatable

Number of pins/wires (left-hand end)

3	3-pin
4	4-pin

Display

	Without LED (standard)
P	LED, PNP
N	LED, NPN
L	LED, DC

Cable characteristics

P	Basic
K	Standard
E	Suitable for use with energy chains
R	Suitable for robot applications

Cable length

0.1 ... 30	0.1 ... 30 m
------------	--------------

Cable designation

	With inscription label holder (standard)
N	Without inscription label holder

Connection technology, right-hand end

LE	Open end
M8	Plug with connecting thread
M12	Plug with connecting thread, A-coded

Plug design

	Open end
G	Straight
W	Angled

Number of pins/wires (right-hand end)

2	2-pin
3	3-pin
4	4-pin

Additional variants can be ordered using the modular product system → 22

- Display
- Cable characteristics
- Number of pins/wires (right-hand end)

Connecting cables NEBU-M12

Type codes

NEBU - M12 G 5 - K - 5 - - LE - 4

Function

NEBU	Connecting cable
------	------------------

Connection technology, left-hand end

M12	Socket with connecting thread, A-coded
-----	--

Socket design

G	Straight
W	Angled

Number of pins/wires (left-hand end)

5	5-pin
---	-------

Display

	Without LED (standard)
P	LED, PNP
N	LED, NPN
P2	2x LED, PNP

Cable characteristics

P	Basic
K	Standard
E	Suitable for use with energy chains
R	Suitable for robot applications

Cable length

0.1 ... 30	0.1 ... 30 m
------------	--------------

Cable designation

	With inscription label holder (standard)
N	Without inscription label holder

Connection technology, right-hand end

LE	Open end
M8	Plug with connecting thread
M12	Plug with connecting thread, A-coded

Plug design

	Open end
G	Straight
W	Angled

Number of pins/wires (right-hand end)

3	3-pin
4	4-pin
5	5-pin

Additional variants can be ordered using the modular product system → 23

- Display
- Cable characteristics

Connecting cables NEBU-LE/M8/M12

Technical data

Connecting cable
NEBU-M8/M12
2, 3, 4 and 5-pin

NEBU-M8R
• Socket rotatable 360°,
engages in 15°-increments

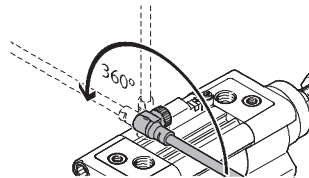

General technical data		NEBU-LE	
Type	NEBU-LE		
Conforms to	EN 61076-2-101		
	EN 61076-2-104		
	EN 61984		
Note on materials	Free of copper and PTFE RoHS-compliant		
Cable characteristics	NEBU-...-E	Halogen-free and oil-resistant	
	NEBU-...-R	Halogen-free and oil-resistant	

General technical data		NEBU-M8			
Type	NEBU-M8				
Cable composition	2x0.25 mm ²	3x0.25 mm ²	4x0.25 mm ²	4x0.25 mm ²	
Display	L	-	P, N	-	P, N
Conforms to	EN 61076-2-104 ¹⁾				
	EN 61984				
CE marking (see declaration of conformity)	-	To EU Low Voltage Directive	-	-	-
Note on materials	Free of copper and PTFE RoHS-compliant				
Cable characteristics	NEBU-...-E	Halogen-free and oil-resistant			
	NEBU-...-R	Halogen-free and oil-resistant			

General technical data		NEBU-M12			
Type	NEBU-M12				
Cable composition	3x0.25 mm ²	4x0.25 mm ²	5x0.25 mm ²	5x0.25 mm ²	
Display	-	P, N	-	P2	-
Conforms to	EN 61076-2-101				
	EN 61984				
CE marking (see declaration of conformity)	To EU Low Voltage Directive	-	To EU Low Voltage Directive	-	To EU Low Voltage Directive
Note on materials	Free of copper and PTFE RoHS-compliant				
Cable characteristics	NEBU-...-E	Halogen-free and oil-resistant			
	NEBU-...-R	Halogen-free and oil-resistant			

1) For NEBU-M8R: Conforms to EN 61076-2-104.

Electronic components		NEBU-M8			
Type	NEBU-M8				
Cable composition	2x0.25 mm ²	3x0.25 mm ²	4x0.25 mm ²	4x0.25 mm ²	
Display	L	-	P, N	-	P, N
Operating voltage range ²⁾ [V AC]	-	0 ... 60	-	0 ... 30	-
Operating voltage range ²⁾ [V DC]	21.6 ... 30	0 ... 60	10 ... 30	0 ... 30	10 ... 30

2) When different connection technologies are combined the lower value applies.

Connecting cables NEBU-LE/M8/M12

Technical data

Type	NEBU-M12					
Cable composition	3x0.25 mm ²		4x0.25 mm ²		5x0.25 mm ²	
Display	–	P, N	–	P2	–	
Operating voltage range ²⁾ [V AC]	0 ... 250	–	0 ... 250	–	0 ... 60	
Operating voltage range ²⁾ [V DC]	0 ... 250	10 ... 30	0 ... 250	10 ... 30	0 ... 60	

2) When different connection technologies are combined the lower value applies.

Electromechanical components									
Type	NEBU-LE			NEBU-M8			NEBU-M12		
Electrical connection	Open end			Socket M8x1			Socket M12x1		
Connection technology, left-hand end									
Electrical connection ³⁾	–			Straight		Rotatable	Straight		
	–			Angled		–	Angled		
	3-wire	–		3-pin		3-pin	–		
	4-wire	–		4-pin		–	–		
	5-wire	–		–		–	5-pin		
Plug coding	–			–			–	A	
Connection technology, right-hand end									
Electrical connection ³⁾	Plug M8x1	Plug M12x1	Open end	Plug M8x1	Plug M12x1	Plug M8x1	Open end	Plug M8x1	Plug M12x1
	Straight		–	Straight		–	Straight		
	Angled		–	Angled		–	Angled		
	–	–	2-wire	–	–	–	–	–	–
	3-pin	3-pin	3-wire	3-pin	3-pin	3-pin	3-wire	3-pin	3-pin
	4-pin	4-pin	4-wire	4-pin	4-pin	–	4-wire	4-pin	4-pin
	5-pin	–	–	–	–	5-wire	–	5-pin	
Plug coding	–	A	–	–	A	–	–	A	
Acceptable current load at 40 °C ²⁾ [A]	–		3 ⁴⁾			0.5	4 ⁵⁾		

Type	NEBU-...-P	NEBU-...-K	NEBU-...-E	NEBU-...-R
Cable characteristics	Basic	Standard	Suitable for use with energy chains	Suitable for robot applications
Cable test conditions	Resistance to bending: to Festo standard			
	–	Energy chain: 5 million cycles, bending radius 75 mm	Energy chain: 5 million cycles, bending radius 28 mm	Energy chain: 5 million cycles, bending radius 28 mm
	–	–	–	Torsional strength: ±270°, test length 0.1 m
	Test conditions on request			
Cable length [m]	0.1 ... 30			
Cable sheath colour	Grey			
Cable composition	M8x1	2x0.25 mm ²		
		3x0.25 mm ²		
		4x0.25 mm ²		
	M12x1	3x0.25 mm ²		
		5x0.25 mm ²		
Cable type	LiYY	LiFY11Y ⁶⁾	Li12Y11Y	Li12Y11Y
Cable sheath materials	PVC-P	TPE-U(PU)	TPE-U(PU)	TPE-U(PU)
Insulating sheath materials	PVC-P	PVC-P ⁶⁾	TPE-E	TPE-E
Pin contact materials	Gold-plated brass			
Cable diameter∅ [mm]	4.5	4.5 ⁶⁾	4.5	4.5
Nominal conductor cross section [mm ²]	0.25			

2) When different connection technologies are combined the lower value applies.

3) Depending on the combination of connection technology.

4) Also applies to display L.

5) Also applies to display P2.

6) For NEBU-...-K with display L and LE connection technology at right-hand end:

Cable type: LiFY11Y, cable diameter∅: 3.4 mm

For NEBU-...-K with display L and M8 or M12 connection technology at right-hand end:

Cable type: LiF9Y11Y

Note on materials: Insulating sheath PP

Cable diameter∅: 3.4 mm

Connecting cables NEBU-LE/M8/M12

Technical data

Mechanical components			
Socket design	Straight	Angled	Rotatable
Rotation range of socket [°]	–	–	360
Housing colour	Black		
Housing materials	TPE-U(PU)		
Union nut materials	Nickel-plated brass		

Display/operation				
Type	NEBU-...P	NEBU-...N	NEBU-...L	NEBU-...P2
Display	LED, PNP	LED, NPN	LED, DC	2x LED, PNP
Ready status display	Green LED	Green LED	–	Green LED
Switching status display	Yellow LED	Yellow LED	Yellow LED	Yellow LED
	–	–	–	Blue LED

Immissions/emissions				
Type	NEBU-...-P	NEBU-...-K	NEBU-...-E	NEBU-...-R
Cable characteristics	Basic	Standard	Suitable for use with energy chains	Suitable for robot applications
Ambient temperature [°C]	–25 ... +70	–25 ... +70	–25 ... +80	–25 ... +80
Ambient temperature with flexible cable installation [°C]	–5 ... +80	–5 ... +70	–5 ... +80	–5 ... +80
Protection class	IP65, IP68			

Type	NEBU-M8				
Cable composition	2x0.25 mm ²	3x0.25 mm ²		4x0.25 mm ²	
Display	L	–	P, N	–	P, N
Surge capacity ²⁾ [kV]	0.8	1.5 ⁷⁾	0.8	0.8	0.8
Degree of contamination	3				

Type	NEBU-M12				
Cable composition	3x0.25 mm ²		4x0.25 mm ²		5x0.25 mm ²
Display	–	P, N	–	P2	–
Surge capacity ²⁾ [kV]	2.5	0.8	2.5	0.8	1.5
Degree of contamination	3				

2) When different connection technologies are combined the lower value applies.

7) For NEBU-M8R: Surge capacity 0.8 kV.

Connecting cables NEBU-LE/M8/M12



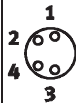

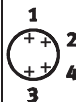
Technical data

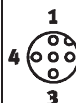
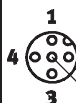
Pin allocation to EN 60947-5-2					
Socket M8x1					
3-pin	Pin	Wire colour	4-pin	Pin	Wire colour
	1	Brown		1	Brown
	3	Blue		2	White
	4	Black		3	Blue
				4	Black

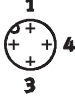
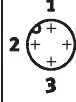
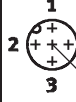
Plug M8x1					
3-pin	Pin	Wire colour	4-pin	Pin	Wire colour
	1	Brown		1	Brown
	3	Blue		2	White
	4	Black		3	Blue
				4	Black

Socket M12x1								
3-pin	Pin	Wire colour	4-pin	Pin	Wire colour	5-pin	Pin	Wire colour
	1	Brown		1	Brown		1	Brown
	3	Blue		2	White		2	White
	4	Black		3	Blue		3	Blue
				4	Black		4	Black
							5	Grey

Plug M12x1								
3-pin	Pin	Wire colour	4-pin	Pin	Wire colour	5-pin	Pin	Wire colour
	1	Brown		1	Brown		1	Brown
	3	Blue		2	White		2	White
	4	Black		3	Blue		3	Blue
				4	Black		4	Black
							5	Grey

Pin allocation – Display L								
Socket M8x1			Plug M8x1				Plug M12x1	
4-pin	Pin	Wire colour	3-pin	Pin	4-pin	Pin	2-pin	Pin
	3	Black		3		3		3
	4	Black		4		4		4

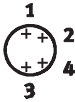
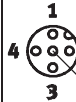
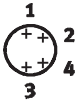
Pin allocation – NEBU-M12 suitable for use with energy chains					
NEBU-M12G5-E-2.5-W2-M8G4-V1			NEBU-M12G5-E-2.5-W3-M8G4-V2		
Socket M12x1, 5-pin	Pin → pin	Plug M8x1, 4-pin	Socket M12x1, 5-pin	Pin → pin	Plug M8x1, 4-pin
	1 → 1			1 → 1	
	3 → 2			3 → 3	
				4 → 4	

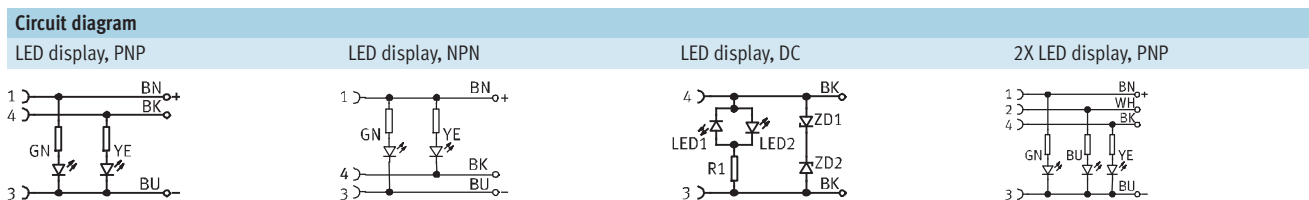

Connecting cables NEBU-LE/M8/M12

Technical data

FESTO

Dimensions – Connection technology at left-hand end

Download CAD Data → www.festo.com/us/cad

Open end

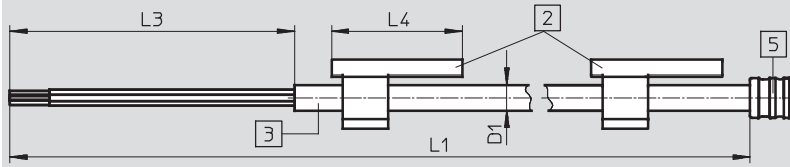

- 2 Inscription label holder
- 3 Cable
- 5 Socket

Socket M8x1, straight

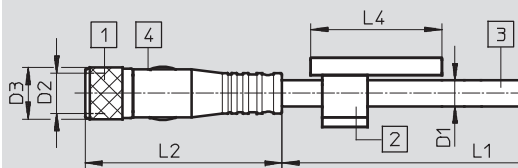

- 1 Socket M8x1, straight
- 2 Inscription label holder
- 3 Cable
- 4 Display field with version P, N or L

Socket M8x1, angled

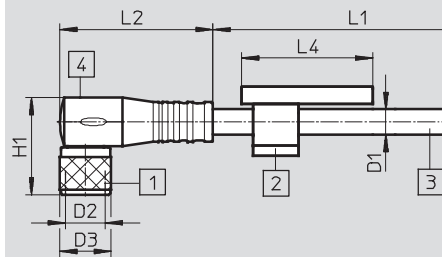

- 1 Socket M8x1, angled
- 2 Inscription label holder
- 3 Cable
- 4 Display field with version P, N or L

Socket M8x1, rotatable

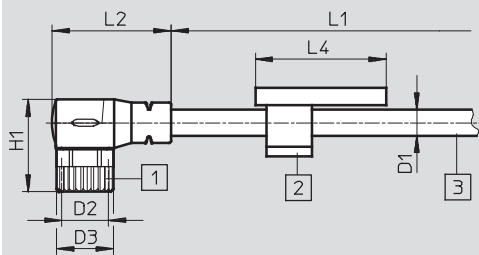

- 1 Socket M8x1, rotatable
- 2 Inscription label holder
- 3 Cable

Type	Connection technology, left-hand end	D1 Ø	D2	D3 Ø	L1 [m]	L2	L3	L4	H1
NEBU-LE	Open end	4.5	-	-	0.1 ... 30	-	50	23	-
NEBU-M8G	Socket M8x1, straight	4.5	M8x1	9	0.1 ... 30	34.6	-	23	-
NEBU-M8W	Socket M8x1, angled					26.9			17
NEBU-M8R	Socket M8x1, rotatable					20.9			16.3
With display									
NEBU-M8GP/-...N/-...L	Socket M8x1, straight	3.4	M8x1	9	0.1 ... 30	34.6	-	23	-
NEBU-M8WP/-...N/-...L	Socket M8x1, angled					26.9			17

Connecting cables NEBU-LE/M8/M12

Technical data

Dimensions – Connection technology at left-hand end

Download CAD Data → www.festo.com/us/cad

Socket M12x1, straight

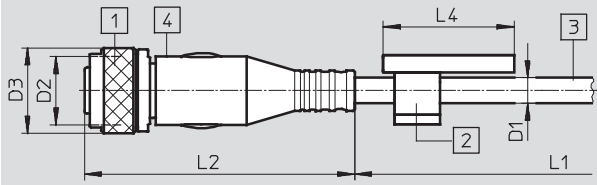

- 1 Socket M12x1, straight
- 2 Inscription label holder
- 3 Cable
- 4 Display field with version P, N or P2

Socket M12x1, angled

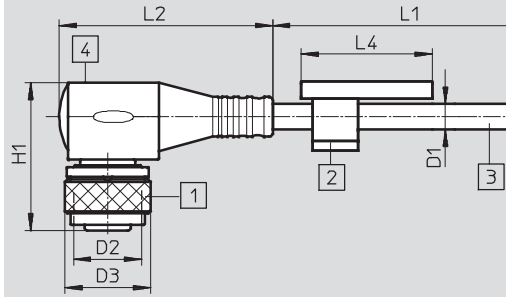

- 1 Socket M12x1, angled
- 2 Inscription label holder
- 3 Cable
- 4 Display field with version P, N or P2

Type	Connection technology, left-hand end	D1 Ø	D2	D3 Ø	L1 [m]	L2	L3	L4	H1
NEBU-M12G	Socket M12x1, straight	4.5	M12x1	15	0.1 ... 30	47.5	-	23	-
NEBU-M12W	Socket M12x1, angled					37.5			26
With display									
NEBU-M12GP/-...N/-...P2	Socket M12x1, straight	4.5	M12x1	15	0.1 ... 30	47.5	-	23	-
NEBU-M12WP/-...N/-...P2	Socket M12x1, angled					37.5			26

Connecting cables NEBU-LE/M8/M12

Technical data

FESTO

Dimensions – Connection technology at right-hand end

Download CAD Data → www.festo.com/us/cad

Open end

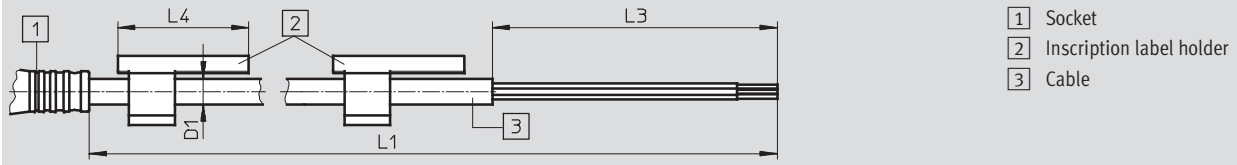

Plug M8x1, straight

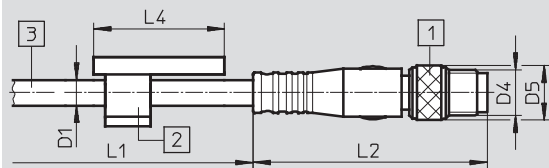

Plug M8x1, angled

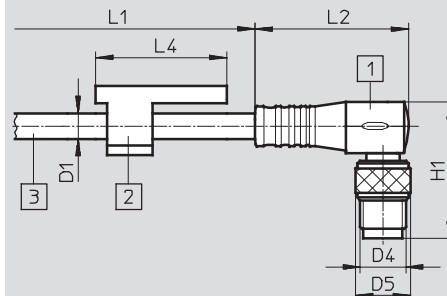

Plug M12x1, straight

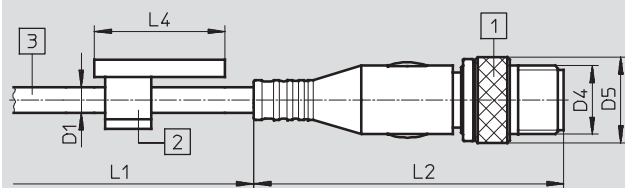

Plug M12x1, angled

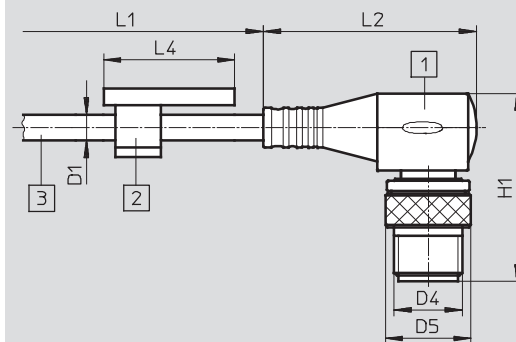

Type	Connection technology, right-hand end	D1 ∅	D4	D5 ∅	L1 [m]	L2	L3	L4	H1
NEBU-M...-LE	Open end	4.5	-	-	0.1 ... 30	-	50	23	-
NEBU-M...-M8G	Plug M8x1, straight	4.5	M8x1	9.6	0.1 ... 30	41.1	-	23	-
NEBU-M...-M8W	Plug M8x1, angled					26.9			24
NEBU-M...-M12G	Plug M12x1, straight	4.5	M12x1	15	0.1 ... 30	54.5	-	23	-
NEBU-M...-M12W	Plug M12x1, angled					37.5			33.2

Connecting cables NEBU-LE/M8/M12

Technical data

FESTO

Ordering data								
Electrical connection				Cable length	Part No.	Type		
Left-hand end		Right-hand end		[m]				
Cable characteristics: Standard								
5-wire	Open end	5-pin	Plug M12x1, straight	1	569840	NEBU-LE5-K-1-M12G5		
3-pin	Socket M8x1, straight	3-wire	Cable, open end	2.5	541333	NEBU-M8G3-K-2.5-LE3		
				5	541334	NEBU-M8G3-K-5-LE3		
				10	541332	NEBU-M8G3-K-10-LE3		
		3-pin	Plug M8x1, straight	0.5	541346	NEBU-M8G3-K-0.5-M8G3		
				1	541347	NEBU-M8G3-K-1-M8G3		
				2.5	541348	NEBU-M8G3-K-2.5-M8G3		
	5			541349	NEBU-M8G3-K-5-M8G3			
	10			569844	NEBU-M8G3-K-10-M8G3			
	4-pin			Plug M8x1, straight	2.5	554037	NEBU-M8G3-K-2.5-M8G4	
	3-pin	Socket M8x1, angled	3-wire	Cable, open end	2.5	541338	NEBU-M8W3-K-2.5-LE3	
					5	541341	NEBU-M8W3-K-5-LE3	
					10	541335	NEBU-M8W3-K-10-LE3	
4-pin			Plug M8x1, straight	2.5	554037	NEBU-M8G3-K-2.5-M8G4		
				5	541343	NEBU-M8G4-K-5-LE4		
				5	541345	NEBU-M8W4-K-5-LE4		
4-pin	Socket M8x1, straight	4-wire	Cable, open end	2.5	541342	NEBU-M8G4-K-2.5-LE4		
				5	541343	NEBU-M8G4-K-5-LE4		
				4-pin	Plug M8x1, straight	2.5	554035	NEBU-M8G4-K-2.5-M8G4
		Socket M8x1, angled	4-wire	Cable, open end	2.5	541344	NEBU-M8W4-K-2.5-LE4	
					5	541345	NEBU-M8W4-K-5-LE4	
					5-pin	Socket M12x1, straight	3-wire	Cable, open end
	5		541364	NEBU-M12G5-K-5-LE3				
	4-wire		2.5	550326	NEBU-M12G5-K-2.5-LE4			
			5	541328	NEBU-M12G5-K-5-LE4			
		5-wire	2.5	541330	NEBU-M12G5-K-2.5-LE5			
	5	541331	NEBU-M12G5-K-5-LE5					
	10	554038	NEBU-M12G5-K-10-LE5					
5-pin	Socket M12x1, angled	3-wire	Cable, open end	2.5	541367	NEBU-M12W5-K-2.5-LE3		
				5	541370	NEBU-M12W5-K-5-LE3		
				4-wire	2.5	550325	NEBU-M12W5-K-2.5-LE4	
		5	541329	NEBU-M12W5-K-5-LE4				
		10	569841	NEBU-M12W5-K-10-LE4				
		5-wire	2.5	567843	NEBU-M12W5-K-2.5-LE5			
	5	567844	NEBU-M12W5-K-5-LE5					
	Cable characteristics: Suitable for use with energy chains							
	3-pin	Socket M8x1, straight	3-wire	Cable, open end	5	569843	NEBU-M8G3-E-5-LE3	
					10	569842	NEBU-M8G3-E-10-LE3	
	5-pin	Socket M12x1, straight	4-pin	Plug M8x1, straight	2.5	554034	NEBU-M12G5-E-2.5-W2-M8G4-V1 ⁸⁾	
					5	554033	NEBU-M12G5-E-2.5-W3-M8G4-V2 ⁹⁾	
Cable characteristics: Suitable for robot applications								
3-pin	Socket M8x1, straight	3-wire	Cable, open end	2.5	569845	NEBU-M8G3-R-2.5-LE3		
				5	569846	NEBU-M8G3-R-5-LE3		
	Socket M8x1, angled	3-wire	Cable, open end	2.5	569847	NEBU-M8W3-R-2.5-LE3		
4-pin	Socket M8x1, straight	4-pin	Plug M8x1, straight	2	556946	NEBU-M8G4-R-2-M8G4		

8) Pin allocation designed for connecting the pressure transmitter SPTW...-A-M12 to the signal converter SVE4-IS

9) Pin allocation designed for connecting the pressure transmitter SPTW...-VD-M12 to the signal converter SVE4-US

Connecting cables NEBU-LE/M8/M12

Technical data

Ordering data							
Electrical connection				Switching output	Cable length [m]	Part No.	Type
Left-hand end		Right-hand end					
With switching status display							
3-pin	Socket M8x1, angled	3-wire	Cable, open end	PNP	2.5	541337	NEBU-M8W3P-K-2.5-LE3
					5	541340	NEBU-M8W3P-K-5-LE3
				NPN	2.5	541336	NEBU-M8W3N-K-2.5-LE3
					5	541339	NEBU-M8W3N-K-5-LE3
5-pin	Socket M12x1, angled	3-wire	Cable, open end	PNP	2.5	541366	NEBU-M12W5P-K-2.5-LE3
					5	541369	NEBU-M12W5P-K-5-LE3
				NPN	2.5	541365	NEBU-M12W5N-K-2.5-LE3
					5	541368	NEBU-M12W5N-K-5-LE3

Connecting cables NEBU-LE

Ordering data – Modular products

Ordering table		Condition	Code	Enter code
M	Module No.	539052		
	Function	Connecting cable	NEBU	NEBU
	Connection technology, left-hand end	Open end	-LE	-LE
M	Number of pins/wires (left-hand end)	3-pin (suitable for open end, M8 plug)	<input type="text" value="10"/>	3
		4-pin (suitable for open end, M8 plug)	<input type="text" value="10"/>	4
		5-pin (suitable for 3, 4 and 5-pin M12 plug)	<input type="text" value="10"/>	5
M	Cable characteristics	Basic		-P
		Standard		-K
		Suitable for use with energy chains		-E
		Suitable for robot applications		-R
	Cable length	0.1 ... 30 m (0.1 ... 2.5 m in 0.1 m increments, 2.5 ... 30 m in 0.5 m increments)		-...
O	Wire cross section	0.25 mm ² (standard)		
	Cable colour	Grey (standard)		
	Cable designation	With inscription label holder (standard)		
		Without inscription label holder		-N
M	Connection technology, right-hand end	Plug with connecting thread M8		-M8
		Plug with connecting thread M12, A-coded		-M12
M	Plug design	Straight		G
		Angled		W
M	Number of pins/wires (right-hand end)	3-pin (suitable for M8/M12 socket)	<input type="text" value="9"/>	3
		4-pin (suitable for M8/M12 socket)	<input type="text" value="9"/>	4
		5-pin (suitable for M12 socket)	<input type="text" value="9"/>	5

3, 4, 5 With LE connection technology at the left-hand end, the number of wires (left-hand end) must be copied over.

3, 4, 5 With LE connection technology at left-hand end, the number of wires chosen must be equal to the number of pins (right-hand end).

Transfer order code

- - - - -

Connecting cables NEBU-M12

Ordering data – Modular products



Ordering table		Conditions	Code	Enter code
M	Module No.	539052		
	Function	Connecting cable	NEBU	NEBU
	Connection technology, left-hand end	Socket with connecting thread M12, A-coded	-M12	-M12
M	Socket design	Straight	G	
		Angled	W	
M	Number of pins/wires (left-hand end)	5-pin (suitable for 3, 4 and 5-pin M12 plug)	5	5
O	Display	Without LED, DC (standard)		
		LED, PNP	1	P
		LED, NPN	1	N
		2x LED, PNP	12	P2
M	Cable characteristics	Basic	-P	
		Standard	-K	
		Suitable for use with energy chains	-E	
		Suitable for robot applications	-R	
	Cable length	0.1 ... 30 m (0.1 ... 2.5 m in 0.1 m increments, 2.5 ... 30 m in 0.5 m increments)	-...	
O	Wire cross section	0.25 mm ² (standard)		
	Cable colour	Grey (standard)		
	Cable designation	With inscription label holder (standard)		
		Without inscription label holder	-N	
M	Connection technology, right-hand end	Open end	-LE	
		Plug with connecting thread M8	-M8	
		Plug with connecting thread M12, A-coded	-M12	
O	Plug design	Straight	2	G
		Angled	2	W
M	Number of pins/wires (right-hand end)	3-pin (suitable for M8/M12 socket)	10	3
		4-pin (suitable for M8/M12 socket)	10	4
		5-pin (suitable for M12 socket)	10	5

- 1 **P, N** Can only be combined with socket design W and number of pins/wires (left-hand end) 5 and number of pins/wires (right-hand end) 3.
- 2 **G, W** Must be selected with M8, M12 connection technology at right-hand end. Cannot be combined with LE connection technology at right-hand end.

- 10 **3, 4, 5** With LE open end at right-hand end, the number of pins/wires must be less than or equal to the number of pins on the opposite side.
- 12 **P2** Can only be combined with socket design W. Can only be combined with number of pins/wires (right-hand end) 4.

Transfer order code

539052	NEBU	-	M12		5		-		-		-			
--------	------	---	-----	--	---	--	---	--	---	--	---	--	--	--

Connecting cables NEBU-M12...8

Technical data

FESTO

Connecting cable
NEBU-M12
8-pin



Electronic components		
Operating voltage range	[V AC]	0 ... 30
Operating voltage range	[V DC]	0 ... 36

Electromechanical components		
Connection technology, left-hand end		
Electrical connection	Angled socket	
	M12x1	
	8-pin	
Plug coding	A	
Connection technology, right-hand end		
Electrical connection	Open end	
	8-wire	
Cable length	[m]	2
		5
		10
Cable sheath colour	Grey	
Cable composition	8x0.25 mm ²	
	Screened	
Wire ends	Tin-plated	
Information on cable sheath materials	PUR	
Min. cable bending radius	[mm]	66
Acceptable current load	[A]	1.5

Immissions/emissions		
Ambient temperature	[°C]	-25 ... +90
Protection class	IP67	

Pin allocation		
Socket M12x1		
8-pin	Pin	Wire colour
	1	White
	2	Brown
	3	Green
	4	Yellow
	5	Grey
	6	Pink
	7	Blue
	8	Red

Connecting cables NEBU-M12...8

Technical data

Dimensions

Download CAD Data → www.festo.com/us/cad

Electrical connection, left-hand end
Socket M12x1, angled

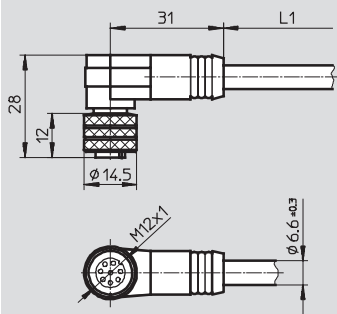

Electrical connection, right-hand end
Open end

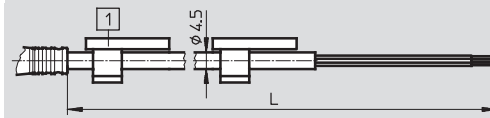

1 Inscription label holder
L Cable length

Ordering data

Electrical connection		Cable length L		Part No.	Type
Left-hand end	Right-hand end	[m]			
Cable property: Standard					
8-pin	Socket M12x1, angled	8-wire	Cable, open end	2	542256 NEBU-M12W8-2-N-LE8
				5	542257 NEBU-M12W8-5-N-LE8
				10	570007 NEBU-M12W8-10-N-LE8

Connecting cables SIM

Type codes

SIM – M8 – [] – 4 – WD – 2,5 – [] – [] – PU – []

Type	
SIM	Plug socket with cable for sensors

Electrical connection	
M8	Union nut M8x1
M12	Union nut M12x1
K	Clip-on plug

Welding field immunity	
	Basic type, no welding field immunity
RS	Welding field immune

Number of wires	
	3-wire
3	3-wire
4	4-wire
5	5-wire
8	8-wire

Connection direction	
GD	In-line
WD	Lateral

Cable length	
2	2 m
2,5	2.5 m
3	3 m
5	5 m
10	10 m

Switching output	
	PNP or NPN
PS	PNP
NS	NPN

Display	
L	LED

Cable sheath material	
PU	Polyurethane
	Polyvinyl chloride

Ease of cleaning	
	Basic version
CDN	Clean Design, suitable for the food industry

Connecting cables SIM-M8/M12

Technical data

Connecting cable
SIM-M8/M12,
3, 4 and 5-pin



General technical data		
Type	SIM-M8	SIM-M12
Conforms to	EN 61076-2-104 EN 61984	EN 61076-2-101
Note on materials	Free of copper and PTFE RoHS-compliant	

Electronic components							
Type	SIM-M8		SIM-M12			SIM-...-...L	
Electrical connection	3-pin	4-pin	3-pin	4-pin	5-pin	3-pin	
Operating voltage range [V AC]	0 ... 60	0 ... 30	0 ... 250	0 ... 250	0 ... 60	–	
Operating voltage range [V DC]	0 ... 60	0 ... 30	0 ... 250	0 ... 250	0 ... 60	10 ... 30	

Electromechanical components							
Type	SIM-M8		SIM-M12			SIM-M8-...-...L	SIM-M12-...-...L
Electrical connection	3-pin	4-pin	3-pin	4-pin	5-pin	3-pin	
Connection technology, left-hand end							
Electrical connection	Straight socket		Straight socket			–	
	Angled socket		Angled socket			–	Angled socket
	M8x1		M12x1			M8x1	M12x1
Electrical connection	3-pin	4-pin	3-pin	4-pin	5-pin	3-pin	
Plug coding	A		A			A	
Connection technology, right-hand end							
Electrical connection	Open end		Open end			Open end	
	3-wire	4-wire	3-wire	4-wire	5-wire	3-wire	
Cable property	Standard						
Cable test conditions	Energy chain: 5 million cycles, bending radius 75 mm						
	Resistance to bending: to Festo standard						
	Test conditions on request						
Cable length [m]	2.5	2.5	2.5	–	2.5	2.5	
	5	5	5	5	5	5	
	10	–	–	–	–	–	
Cable sheath colour	Grey					Grey	
Cable composition	3x0.25 mm ²	4x0.25 mm ²	3x0.25 mm ²	4x0.25 mm ²	5x0.25 mm ²	3x0.25 mm ²	
Information on cable sheath materials	TPE-U(PU)		TPE-U(PU)			TPE-U(PU)	
Information on insulating sheath materials	PVC		PVC			PVC	
Cable diameter [mm]	4.5		4.5			4.5	
Conductor nominal cross section [mm ²]	0.25		0.25			0.25	
Acceptable current load at 40 °C [A]	3		4			3	4



Mechanical components	
Housing colour	Black
Information on housing materials	TPE-U(PU)
Information on union nut materials	Nickel-plated brass



Connecting cables SIM-M8/M12

Technical data

Display/operation	
Type	SIM-...-...L
Ready status display	Green LED
Switching status display	Yellow LED

Immissions/emissions						
Type	SIM-M8		SIM-M12			SIM-...-...L
Electrical connection	3-pin	4-pin	3-pin	4-pin	5-pin	3-pin
Ambient temperature [°C]	-25 ... +70		-25 ... +70			-25 ... +70
Ambient temperature with flexible cable installation [°C]	-5 ... +70		-5 ... +70			-5 ... +70
Protection class	IP65, IP68		IP65, IP68			IP65, IP68
Surge capacity [kV]	1.5	0.8	2.5	2.5	1.5	0.8
Degree of contamination	3		3			3

Pin allocation to EN 60947-5-2						
M8x1						
Socket, 3-pin	Pin	Wire colour	Socket, 4-pin	Pin	Wire colour	
	1	Brown		1	Brown	
	3	Blue		2	White	
	4	Black		3	Blue	
				4	Black	

M12x1								
Socket, 3-pin	Pin	Wire colour	Socket, 4-pin	Pin	Wire colour	Socket, 5-pin	Pin	Wire colour
	1	Brown		1	Brown		1	Brown
	3	Blue		2	White		2	White
	4	Black		3	Blue		3	Blue
		4		Black	4		Black	
				5	Grey			

Dimensions Download CAD Data → www.festo.com/us/cad

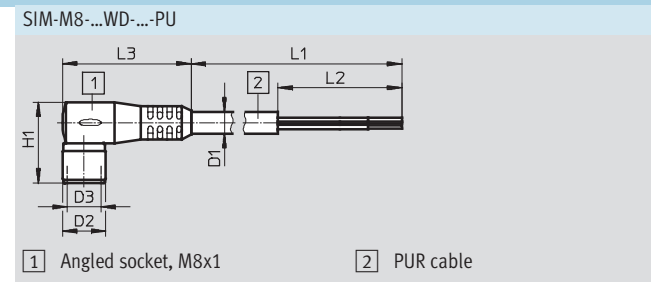
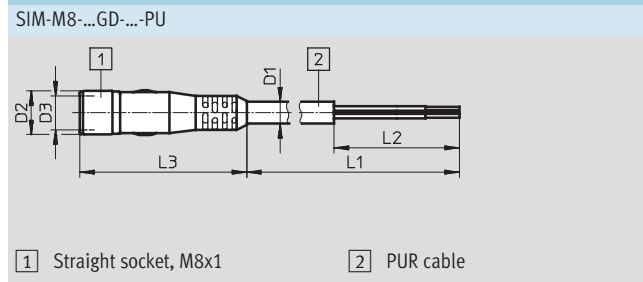

	D1	D2	D3	H1	L1	L2	L3
	∅	∅					
	±0.1	±0.1		+0.3/-0.4	+3%	±2	+0.4/-0.5
SIM-M8-...GD-2,5-PU	4.5	9	M8x1	-	2,500	50	34.4
SIM-M8-...GD-5-PU					5,000		
SIM-M8-...GD-10-PU					10,000		
SIM-M8-...WD-2,5-PU	4.5	9	M8x1	16.8	2,500	50	26.8
SIM-M8-...WD-5-PU					5,000		
SIM-M8-...WD-10-PU					10,000		

Connecting cables SIM-M8/M12

Technical data

Dimensions

Download CAD Data → www.festo.com/us/cad

SIM-M12-...GD-...-PU

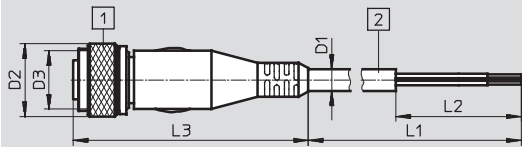

- 1 Straight socket, M12x1
- 2 PUR cable

SIM-M12-...WD-...-PU

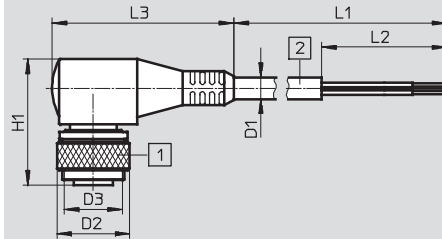

- 1 Angled socket, M12x1
- 2 PUR cable

	D1 ∅ ±0.1	D2 ∅	D3	H1	L1 +3%	L2 ±2	L3
SIM-M12-...GD-2,5-PU	4.5	15	M12x1	-	2,500	50	48.5
SIM-M12-...GD-5-PU					5,000		
SIM-M12-...WD-2,5-PU	4.5	15	M12x1	26	2,500	50	37.5
SIM-M12-...WD-5-PU					5,000		

Dimensions

Download CAD Data → www.festo.com/us/cad

SIM-M8-...WD-2,5-...L-PU

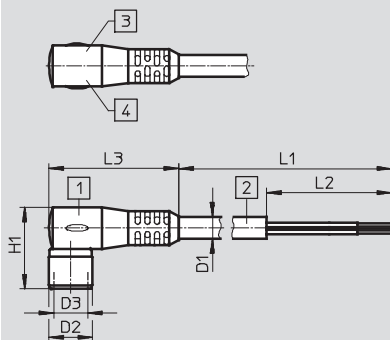

- 1 Angled socket, M8x1
- 2 PUR cable
- 3 Switching status display, yellow LED
- 4 Operating status display, green LED

SIM-M12-...WD-2,5-...L-PU

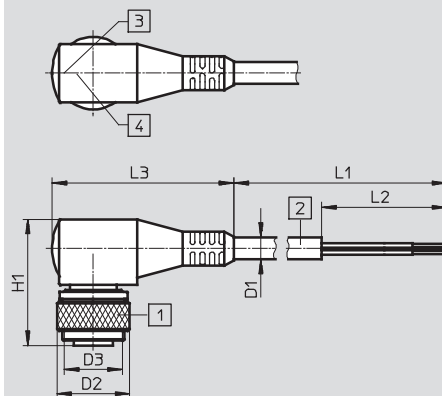

- 1 Angled socket, M12x1
- 2 PUR cable
- 3 Switching status display, yellow LED
- 4 Operating status display, green LED

	D1 ∅ ±0.1	D2 ∅ ±0.2	D3	H1 +0.3/-0.4	L1 +3%	L2 ±2	L3
SIM-M8-...WD-2,5-...L-PU	4.5	9	M8x1	16.8	2,500	50	26.8
SIM-M8-...WD-5-...L-PU					5,000		
SIM-M12-...WD-2,5-...L-PU	4.5	15	M12x1	26	2,500	50	37.5
SIM-M12-...WD-5-...L-PU					5,000		

Connecting cables SIM-M8/M12

Technical data

Ordering data					
Electrical connection		Number of wires	Cable length [m]	Part No.	Type
Left-hand end	Right-hand end				
Cable property: Standard					
Socket M8x1, straight	Open end	3	2.5	159420	SIM-M8-3GD-2,5-PU
			5	159421	SIM-M8-3GD-5-PU
			10	192964	SIM-M8-3GD-10-PU
		4	2.5	158960	SIM-M8-4GD-2,5-PU
			5	158961	SIM-M8-4GD-5-PU
			10	192965	SIM-M8-4GD-10-PU
Socket M8x1, angled	Open end	3	2.5	159422	SIM-M8-3WD-2,5-PU
			5	159423	SIM-M8-3WD-5-PU
			10	192965	SIM-M8-3WD-10-PU
		4	2.5	158962	SIM-M8-4WD-2,5-PU
			5	158963	SIM-M8-4WD-5-PU
			10	192966	SIM-M8-4WD-10-PU
Socket M12x1, straight	Open end	3	2.5	159428	SIM-M12-3GD-2,5-PU
			5	159429	SIM-M12-3GD-5-PU
			10	164259	SIM-M12-3GD-10-PU
		4	2.5	175715	SIM-M12-4GD-2,5-PU
			5	175716	SIM-M12-4GD-5-PU
			10	164260	SIM-M12-4GD-10-PU
Socket M12x1, angled	Open end	3	2.5	159430	SIM-M12-3WD-2,5-PU
			5	159431	SIM-M12-3WD-5-PU
			10	164258	SIM-M12-3WD-10-PU
		4	2.5	164258	SIM-M12-4WD-2,5-PU
			5	164259	SIM-M12-4WD-5-PU
			10	164260	SIM-M12-4WD-10-PU
With switching status display for sensor with switching output PNP					
Socket M8x1, angled	Open end	3	2.5	159424	SIM-M8-3WD-2,5-PSL-PU
			5	159425	SIM-M8-3WD-5-PSL-PU
Socket M12x1, angled	Open end	3	2.5	159432	SIM-M12-3WD-2,5-PSL-PU
			5	159433	SIM-M12-3WD-5-PSL-PU
With switching status display for sensor with switching output NPN					
Socket M8x1, angled	Open end	3	2.5	159426	SIM-M8-3WD-2,5-NSL-PU
			5	159427	SIM-M8-3WD-5-NSL-PU
Socket M12x1, angled	Open end	3	2.5	159434	SIM-M12-3WD-2,5-NSL-PU
			5	159435	SIM-M12-3WD-5-NSL-PU

Connecting cables SIM-M12-8

Technical data

FESTO

Connecting cable
SIM-M12,
8-pin



General technical data	
Note on materials	RoHS-compliant

Electronic components		
Operating voltage range	[V AC]	0 ... 45
Operating voltage range	[V DC]	0 ... 70

Electromechanical components		
Connection technology, left-hand end		
Electrical connection	Straight socket	
	M12x1	
	8-pin	
Connection technology, right-hand end		
Electrical connection	Open end	
	8-wire	
Cable length	[m]	2
		5
		10
Cable sheath colour	Grey	
Cable composition	8x0.25 mm ²	
Information on cable sheath materials	PUR	
Acceptable current load at 40 °C	[A]	1.5

Immissions/emissions		
Ambient temperature	[°C]	-25 ... +80
Protection class	IP68	

Pin allocation					
M12x1					
Socket, 8-pin	Pin	Wire colour	Pin	Wire colour	
	1	White	5	Grey	
	2	Brown	6	Pink	
	3	Green	7	Blue	
	4	Yellow	8	Red	

Connecting cables SIM-M12-8

Technical data

Dimensions Download CAD Data → www.festo.com/us/cad

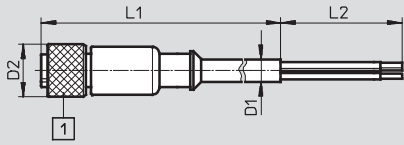

1 Union nut M12x1

	D1 Ø ±0.2	D2 Ø +0.5	L1 ±3%	L2 +20
SIM-M12-8GD-2-PU	6.2	14.6	2,000	50
SIM-M12-8GD-5-PU			5,000	
SIM-M12-8GD-10-PU			10,000	

Electrical connection		Number of wires	Cable length [m]	Part No.	Type
Left-hand end	Right-hand end				
Socket M12x1, straight	Open end	8	2	525616	SIM-M12-8GD-2-PU
			5	525618	SIM-M12-8GD-5-PU
			10	570008	SIM-M12-8GD-10-PU

Connecting cables KM12

Technical data

FESTO

Connecting cable
KM12,
8-pin



Electronic components		
Operating voltage range	[V AC]	0 ... 30
Operating voltage range	[V DC]	0 ... 36

Electromechanical components		
Connection technology, left-hand end		
Electrical connection		Straight plug
		M1 2x1
		8-pin
Connection technology, right-hand end		
Electrical connection		Straight socket
		M1 2x1
		8-wire
Information on pin contact materials		Nickel-plated and gold-plated bronze
Cable length	[m]	2
Cable composition		8x0.25 mm ²
Information on cable sheath materials		PUR
Cable diameter	[mm]	6.2
Acceptable current load	[A]	1.5

Mechanical components		
Type of mounting		Via threaded connector
		Via union nut
Mounting position		Any
Product weight	[g]	156
Information on union nut materials		Nickel-plated brass

Immissions/emissions		
Ambient temperature	[°C]	-25 ... +80
Protection class		IP68

Connecting cables KM12

Technical data

FESTO

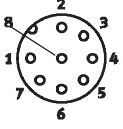
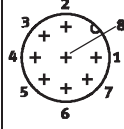
Pin allocation					
M12x1					
Socket, 8-pin	Pin	Wire colour	Plug, 8-pin	Pin	Wire colour
	1	White		1	White
	2	Brown		2	Brown
	3	Green		3	Green
	4	Yellow		4	Yellow
	5	Grey		5	Grey
	6	Pink		6	Pink
	7	Blue		7	Blue
	8	Red		8	Red
	Housing	Screened		Housing	Screened

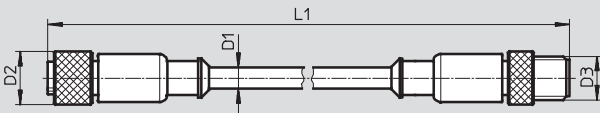
Dimensions	Download CAD Data → www.festo.com/us/cad			
				

	D1	D2	D3	L1
	∅	∅		
	±0.2			±3%
KM12-8GD8GS-2-PU	6.2	14.6	M12x1	2,000

Ordering data					
Electrical connection		Number of wires	Cable length [m]	Part No.	Type
Left-hand end	Right-hand end				
Straight socket, M12x1	Straight plug, M12x1	8	2	525617	KM12-8GD8GS-2-PU

Connecting cables SIM, welding field immune

Technical data

Connecting cable SIM-M12-RS,
3-pin, welding field immune

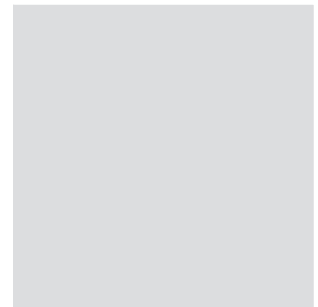

Electronic components		
Operating voltage range	[V AC]	0 ... 45
Operating voltage range	[V DC]	0 ... 70

Electromechanical components		
Type	SIM-...-...-3GD	SIM-...-...-3WD
Connection technology, left-hand end		
Electrical connection	Straight socket	Angled socket
	M12x1	
	3-pin	
Connection technology, right-hand end		
Electrical connection	Open end	
	3-wire	
Cable property	Standard	
Cable test conditions	Energy chain: 5 million cycles, bending radius 75 mm	
	Resistance to bending: to Festo standard	
	Test conditions on request	
Cable length	[m]	3
Cable sheath colour	Orange	
Cable composition	3x0.5 mm ²	
Information on cable sheath materials	PVC, radiation crosslinking	
Acceptable current load	[A]	4

Mechanical components	
Information on housing materials	TPE-U(PU)
Information on union nut materials	Nickel-plated brass

Immissions/emissions		
Ambient temperature	[°C]	-25 ... +80
Ambient temperature with flexible cable installation	[°C]	0 ... +80
Protection class	IP65, IP67	

Pin allocation to EN 60947-5-2		
M12x1		
Socket, 3-pin	Pin	Wire colour
	1	Brown
	3	Blue
	4	Black

Connecting cables SIM, welding field immune

Technical data

Download CAD Data → www.festo.com/us/cad

Dimensions
SIM-...-...-3GD

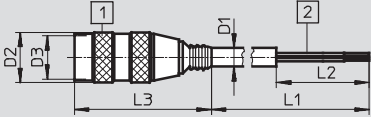

1 Union nut 2 PVC cable

Dimensions
SIM-...-...-3WD

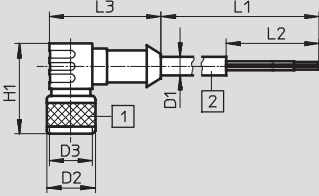

1 Union nut 2 PVC cable

	D1 ∅ ±0.3	D2 ∅	D3	H1 ±0.5	L1 ±3%	L2 ±8	L3 ±0.5
SIM-M12-RS-3GD-3	5.2	15 ±0.2	M12x1	-	3,000	50	38
SIM-M12-RS-3WD-3	5.2	13.5 ±0.3	M12x1	25	3,000	50	31

Electrical connection		Number of wires	Cable length [m]	Part No.	Type
Left-hand end	Right-hand end				
Welding field immune					
Straight socket, M12x1	Open end	3	3	30450	SIM-M12-RS-3GD-3
Angled socket, M12x1	Open end	3	3	30451	SIM-M12-RS-3WD-3

Connecting cables SIM, clip-on

Technical data

FESTO

Connecting cable
SIM-K,
3 and 4-pin, clip-on



General technical data	
Conforms to	EN 61076-2-104 EN 61984
Note on materials	Free of copper and PTFE RoHS-compliant

Electronic components			
Electrical connection		3-pin	4-pin
Operating voltage range	[V AC]	0 ... 60	0 ... 30
Operating voltage range	[V DC]	0 ... 60	0 ... 30

Electromechanical components			
Electrical connection		3-pin	4-pin
Connection technology, left-hand end			
Electrical connection	Straight socket		
	Angled socket		
	3-pin	4-pin	
	Clip-on		
Plug coding	A		
Connection technology, right-hand end			
Electrical connection	Open end		
	3-wire	4-wire	
Cable property	Standard		
Cable test conditions	Energy chain: 5 million cycles, bending radius 75 mm		
	Resistance to bending: to Festo standard		
	Test conditions on request		
Cable length [m]	2.5	2.5	
	5	5	
	10	-	
Cable sheath colour	Grey		
Cable composition	3x0.25 mm ²	4x0.25 mm ²	
Information on cable sheath materials	TPE-U(PU)		
Information on insulating sheath materials	PVC		
Cable diameter [mm]	4.5		
Conductor nominal cross section [mm ²]	0.25		
Acceptable current load at 40 °C [A]	3		

Mechanical components	
Housing colour	Black
Information on housing materials	TPE-U(PU)

Connecting cables SIM, clip-on

Technical data

Immissions/emissions		
Electrical connection	3-pin	4-pin
Ambient temperature [°C]	-25 ... +70	
Ambient temperature with flexible cable installation [°C]	-5 ... +70	
Protection class	IP65, IP67	
Surge capacity [kV]	1.5	0.8
Degree of contamination	3	

Pin allocation to EN 60947-5-2			Download CAD Data → www.festo.com/us/cad		
Socket, 3-pin	Pin	Wire colour	Socket, 4-pin	Pin	Wire colour
	1	Brown		1	Brown
	3	Blue		2	White
	4	Black		3	Blue
				4	Black

Dimensions

SIM-K-...-GD-...-PU

1 Straight socket 2 PUR cable

SIM-K-...-WD-...-PU

1 Angled socket 2 PUR cable

	D1 ∅	D2 ∅	H1	L1 +3% [m]	L2 ±2	L3 ±0.4
SIM-K-...-GD-2,5-PU	4.5	8.5	-	2.5	50	33.6
SIM-K-...-GD-5-PU				5		
SIM-K-...-GD-10-PU				10		
SIM-K-...-WD-2,5-PU	4.5	8.5	18.4	2.5	50	26.8
SIM-K-...-WD-5-PU				5		
SIM-K-...-WD-10-PU				10		

Ordering data						
Electrical connection		Number of wires	Cable length [m]	Part No.	Type	
Left-hand end	Right-hand end					
Clip-on						
Straight socket	Open end	3	2.5	164257	SIM-K-GD-2,5-PU	
			5	164256	SIM-K-GD-5-PU	
			10	192962	SIM-K-GD-10-PU	
Angled socket	Open end	3	2.5	164255	SIM-K-WD-2,5-PU	
			5	164254	SIM-K-WD-5-PU	
			10	192963	SIM-K-WD-10-PU	
Straight socket	Open end	4	2.5	164250	SIM-K-4-GD-2,5-PU	
			5	164251	SIM-K-4-GD-5-PU	
Angled socket	Open end	4	2.5	164252	SIM-K-4-WD-2,5-PU	
			5	164253	SIM-K-4-WD-5-PU	

Do not use for new designs!
 Type discontinued

FESTO

Connecting cables SIM, Clean Design

Technical data

Connecting cable
SIM-K-...-CDN,
3-pin, clip-on, Clean Design

Suitable for food, resistant to cleaning
and disinfecting agents to DIN 11483



General technical data	
Conforms to	EN 61076-2-104 EN 61984
Note on materials	Free of copper and PTFE RoHS-compliant

Electronic components		
Operating voltage range	[V AC]	0 ... 60
Operating voltage range	[V DC]	0 ... 60

Electromechanical components		
Connection technology, left-hand end		
Electrical connection		Straight socket
		Angled socket
		3-pin
		Clip-on
Plug coding		A
Connection technology, right-hand end		
Electrical connection		Open end
		3-wire
Cable property		Standard
Cable test conditions		Energy chain: 5 million cycles, bending radius 75 mm
		Resistance to bending: to Festo standard
		Test conditions on request
Cable length	[m]	2.5
		5
Cable sheath colour		Grey
Cable composition		3x0.25 mm ²
Information on cable sheath materials		PVC, radiation crosslinking
Information on insulating sheath materials		PVC, radiation crosslinking
Cable diameter	[mm]	4.5
Conductor nominal cross section	[mm ²]	0.25
Acceptable current load at 40 °C	[A]	3

Mechanical components	
Housing colour	Black
Information on housing materials	TPE-U(PU)

Do not use for new designs!

- I - Type discontinued

Connecting cables SIM, Clean Design

Technical data

FESTO

Immissions/emissions		
Ambient temperature	[°C]	-25 ... +70
Ambient temperature with flexible cable installation	[°C]	-5 ... +70
Protection class		IP65, IP67, IP69K
Surge capacity	[kV]	1.5
Degree of contamination		3

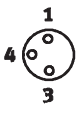
Pin allocation to EN 60947-5-2		
Socket, 3-pin	Pin	Wire colour
	1	Brown
	3	Blue
	4	Black

Dimensions

SIM-K-GD-...-CDN

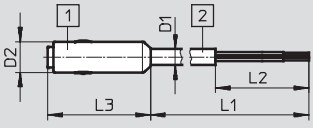

1 Straight socket 2 PUR cable

Download CAD Data → www.festo.com/us/cad

SIM-K-WD-...-CDN

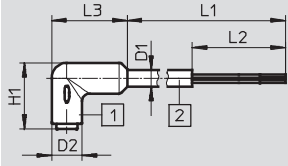

1 Angled socket 2 PUR cable



	D1 ∅ ±0.1	D2 ∅	H1	L1 +3% [m]	L2 ±2	L3
SIM-K-GD-2,5-CDN	4.5	8.5	-	2.5	50	28.5
SIM-K-GD-5-CDN				5		
SIM-K-WD-2,5-CDN	4.5	8.5	18.4	2.5	50	21
SIM-K-WD-5-CDN				5		

Ordering data						
Electrical connection		Number of wires	Cable length [m]	Part No.	Type	
Left-hand end	Right-hand end					
Clean Design						
Straight socket	Open end	3	2.5	525259	SIM-K-GD-2,5-CDN	
			5	525260	SIM-K-GD-5-CDN	
Angled socket	Open end	3	2.5	525261	SIM-K-WD-2,5-CDN	
			5	525262	SIM-K-WD-5-CDN	

Connecting cables, universal

Accessories

FESTO

Ordering data						
	Material	Use	Size	Part No.	Type	PU ¹⁾
Inscription label						
	Polycarbonate	For insertion in the inscription label holder	23x4 mm	541598	ASLR-L-423	34
Safety clip						
	Polyamide	For protecting against inadvertent disconnection of the union nuts (no tool needed) For captive attachment to the cable	M8	548067	NEAU-M8-GD	1
			M12	548068	NEAU-M12-GD	1

1) Packaging unit per frame

Product Range and Company Overview

A Complete Suite of Automation Services

Our experienced engineers provide complete support at every stage of your development process, including: conceptualization, analysis, engineering, design, assembly, documentation, validation, and production.



Custom Automation Components
Complete custom engineered solutions



Custom Control Cabinets
Comprehensive engineering support and on-site services

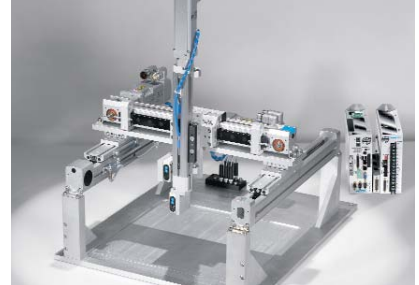

Complete Systems
Shipment, stocking and storage services

The Broadest Range of Automation Components

With a comprehensive line of more than 30,000 automation components, Festo is capable of solving the most complex automation requirements.



Electromechanical
Electromechanical actuators, motors, controllers & drives



Pneumatics
Pneumatic linear and rotary actuators, valves, and air supply



PLCs and I/O Devices
PLC's, operator interfaces, sensors and I/O devices

Supporting Advanced Automation... As No One Else Can!

Festo is a leading global manufacturer of pneumatic and electromechanical systems, components and controls for industrial automation, with more than 12,000 employees in 56 national headquarters serving more than 180 countries. For more than 80 years, Festo has continuously elevated the state of manufacturing with innovations and optimized motion control solutions that deliver higher performing, more profitable automated manufacturing and processing equipment. Our dedication to the advancement of automation extends beyond technology to the education and development of current and future automation and robotics designers with simulation tools, teaching programs, and on-site services.

Quality Assurance, ISO 9001 and ISO 14001 Certifications

Festo Corporation is committed to supply all Festo products and services that will meet or exceed our customers' requirements in product quality, delivery, customer service and satisfaction.

To meet this commitment, we strive to ensure a consistent, integrated, and systematic approach to management that will meet or exceed the requirements of the ISO 9001 standard for Quality Management and the ISO 14001 standard for Environmental Management.



© Copyright 2008, Festo Corporation. While every effort is made to ensure that all dimensions and specifications are correct, Festo cannot guarantee that publications are completely free of any error, in particular typing or printing errors. Accordingly, Festo cannot be held responsible for the same. For Liability and Warranty conditions, refer to our "Terms and Conditions of Sale", available from your local Festo office. All rights reserved. No part of this publication may be reproduced, distributed, or transmitted in any form or by any means, electronic, mechanical, photocopying or otherwise, without the prior written permission of Festo. All technical data subject to change according to technical update.



Printed on recycled paper at New Horizon Graphic, Inc., FSC certified as an environmentally friendly printing plant.

Festo North America

Festo Regional Contact Center

5300 Explorer Drive
Mississauga, Ontario L4W 5G4
Canada

USA Customers:

For ordering assistance,

Call: 1.800.99.FESTO (1.800.993.3786)

Fax: 1.800.96.FESTO (1.800.963.3786)

Email: customer.service@us.festo.com

For technical support,

Call: 1.866.GO.FESTO (1.866.463.3786)

Fax: 1.800.96.FESTO (1.800.963.3786)

Email: product.support@us.festo.com

Canadian Customers:

Call: 1.877.GO.FESTO (1.877.463.3786)

Fax: 1.877.FX.FESTO (1.877.393.3786)

Email: festo.canada@ca.festo.com

USA Headquarters

Festo Corporation
395 Moreland Road
P.O. Box 18023
Hauppauge, NY 11788, USA
www.festo.com/us

USA Sales Offices

Appleton

North 922 Tower View Drive, Suite N
Greenville, WI 54942, USA

Boston

120 Presidential Way, Suite 330
Woburn, MA 01801, USA

Chicago

1441 East Business Center Drive
Mt. Prospect, IL 60056, USA

Dallas

1825 Lakeway Drive, Suite 600
Lewisville, TX 75057, USA

Detroit – Automotive Engineering Center

2601 Cambridge Court, Suite 320
Auburn Hills, MI 48326, USA

New York

395 Moreland Road
Hauppauge, NY 11788, USA

Silicon Valley

4935 Southfront Road, Suite F
Livermore, CA 94550, USA

United States



USA Headquarters, East: Festo Corp., 395 Moreland Road, Hauppauge, NY 11788

Phone: 1.631.435.0800; Fax: 1.631.435.8026;

Email: info@festo-usa.com

www.festo.com/us

Canada



Headquarters: Festo Inc., 5300 Explorer Drive, Mississauga, Ontario L4W 5G4

Phone: 1.905.624.9000; Fax: 1.905.624.9001;

Email: festo.canada@ca.festo.com

www.festo.ca

Mexico



Headquarters: Festo Pneumatic, S.A., Av. Ceylán 3, Col. Tequesquahuac,
54020 Tlalneantla, Edo. de México

Phone: 011 52 [55] 53 21 66 00; Fax: 011 52 [55] 53 21 66 65;

Email: festo.mexico@mx.festo.com

www.festo.com/mx

Central USA

Festo Corporation
1441 East Business
Center Drive
Mt. Prospect, IL 60056, USA
Phone: 1.847.759.2600
Fax: 1.847.768.9480



Western USA

Festo Corporation
4935 Southfront Road,
Suite F
Livermore, CA 94550, USA
Phone: 1.925.371.1099
Fax: 1.925.245.1286



Festo Worldwide

Argentina Australia Austria Belarus Belgium Brazil Bulgaria Canada Chile China Colombia Croatia Czech Republic Denmark
Estonia Finland France Germany Great Britain Greece Hong Kong Hungary India Indonesia Iran Ireland Israel Italy Japan Latvia
Lithuania Malaysia Mexico Netherlands New Zealand Norway Peru Philippines Poland Romania Russia Serbia Singapore
Slovakia Slovenia South Africa South Korea Spain Sweden Switzerland Taiwan Thailand Turkey Ukraine United States Venezuela

www.festo.com