

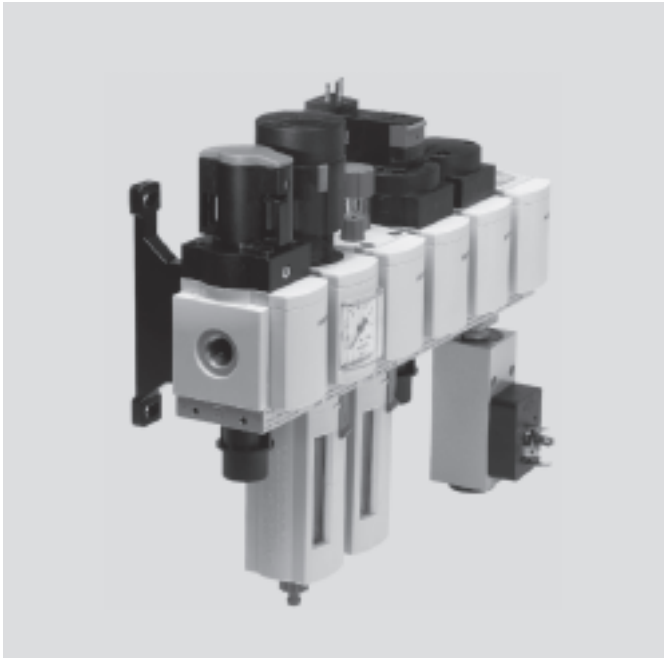







## Pre-configured Combination Units MSB4N – Inch Series

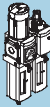

Ten different types of pre-configured and assembled combination units are available. They consist of up to six different individual units with options for filtration grade and condensate drain (see table below). Mounting brackets are included. MS Series combination units have a high resistance to corrosion in typical industrial environments and offer high flow rates with compact components.

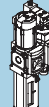
- Pneumatic connections: 1/8 NPT, 1/4 NPT (3/8 NPT with optional port plate)
- Flow rate: 19.4 ... 49.4 scfm\*
- Supply pressure: 12 ... 206 psi\*
- Pressure regulation range: 4.4 ... 176 psi\*
- Filtration grade: 5 µm and 40 µm

\* Individual combination units will vary depending on selected type and option.

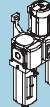
Combination Units											
		MSB4N-FRC	Unit 1	Unit 2	Unit 3	Unit 4	Unit 5	Unit 6	Unit 7	Unit 8	Unit 9
<b>Consisting of:</b>											
On-off valve (manually actuated)	EM1	-	■	-	■	■	-	■	■	■	-
Filter regulator with pressure gauge, lockable	LFR	■	■	■	■	■	■	■	■	■	-
Pressure regulator with pressure gauge, lockable	LR	-	-	-	-	-	-	-	-	-	■
Filter	LF	-	-	-	-	-	-	-	-	-	■
Lubricator	LOE	■	■	■	■	-	-	-	-	■	■
On-off valve (solenoid actuated)	EE	-	-	■	■	-	■	-	■	-	-
Soft-start valve (pneumatically actuated)	DL	-	-	■	■	-	■	-	■	-	-
Distribution block with pressure switch	FRM	-	■	-	■	-	-	■	■	-	-
Mounting bracket	WP	-	■	■	■	■	■	■	■	■	■
<b>Technical data → Page</b>		50	56	59	63	67	70	74	77	81	84

**Note**

Should you require a custom combination unit, please go to our online catalog at: [www.festo.com/catalog/msb4n](http://www.festo.com/catalog/msb4n). Click on the blue basket icon  next to P/N 532306. Then open the shopping basket on the right menu and click on the configuration icon . You can now configure your combination unit.

# Pre-configured Combination Units MSB4N-FRC – Inch Series

Technical Data

ISO Symbol

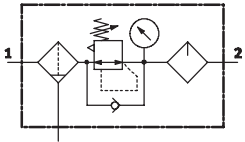

With manual bowl drain

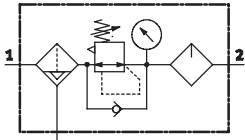

With fully automatic bowl drain

- Filter, regulator and lubricator function in a single unit
- High flow rate and highly efficient removal of contaminants
- Good regulating characteristics with minimal pressure hysteresis
- Setting values are secured by locking the rotary knob
- Lockable rotary knob
- Two pressure regulation ranges: 4.4 ... 103 psi and 7.4 ... 176 psi
- Choice of filter cartridges: 5 µm or 40 µm
- With manual or integrated, fully automatic bowl drain



General Technical Data		
Pneumatic connection 1, 2	1/8 NPT	1/4 NPT
Design	Filter regulator with pressure gauge Proportional standard mist lubricator	
Regulating function	With primary pressure compensation	
	With secondary venting	
	With return flow function	
	Output pressure constant	
Type of mounting	Via accessories	
Assembly position	Vertical ±5°	
Filtration grade	[µm]	5 (air purity class at the output 3.7.- to DIN ISO 8573-1)
		40 (air purity class at the output 5.7.- to DIN ISO 8573-1)
Bowl guard	Plastic bowl guard	
Bowl drains	Manual	
	Fully automatic	
Pressure adjustment	Rotary knob with integrated lock	
Pressure regulation range	[psi]	4.4 ... 103
		7.4 ... 176
Pressure indicator	With pressure gauge	

# Pre-configured Combination Units MSB4N-FRC – Inch Series

Technical Data

Standard Nominal Flow Rate $q_{nN}^{1)}$ [scfm]			
Pneumatic connection		1/8 NPT	1/4 NPT
Pressure regulation range 4.4... 103 psi			
Filtration grade	5 $\mu\text{m}$	31.8	45.9
	40 $\mu\text{m}$	33.5	49.4
Pressure regulation range 7.4... 176 psi			
Filtration grade	5 $\mu\text{m}$	28.2	30.0
	40 $\mu\text{m}$	30.0	31.8

1) Measured at  $p_1 = 147$  psi and  $p_2 = 88$  psi,  $\Delta p = 15$  psi.

Operating and Environmental Conditions		
Bowl drains	Manual	Fully automatic
Supply pressure [psi]	22 ... 206	22 ... 176
Operating medium	Compressed air	
Ambient temperature [°F]	14 ... 140	41 ... 140
Temperature of medium [°F]	14 ... 140	41 ... 140
Storage temperature [°F]	14 ... 140	14 ... 140
Corrosion resistance CRC <sup>2)</sup>	2	

2) Corrosion resistance class 2 according to Festo standard 940 070  
 Components requiring moderate corrosion resistance. Externally visible parts with primarily decorative surface requirements which are in direct contact with a normal industrial environment or media such as coolants or lubricating agents.

Weights [lb]	
With plastic bowl guard	1.00

• For spare parts go to: [www.festo.com/en/spare\\_parts\\_service](http://www.festo.com/en/spare_parts_service)

## Materials

Sectional view

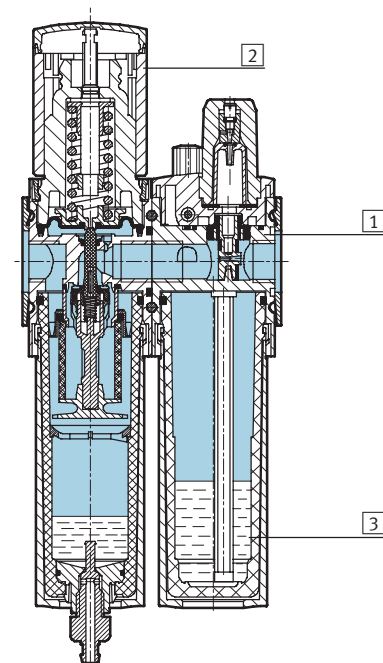

Service unit		
[1]	Body	Die-cast aluminum
[2]	Regulating knob	Polyamide/polyacetate
[3]	Plastic bowl guard	Polycarbonate
-	Seals	Nitrile rubber

# Pre-configured Combination Units MSB4N-FRC – Inch Series



Technical Data

## Standard Flow Rate $q_n$ as a Function of Output Pressure $p_2$

Pressure regulation range 4.4 ... 103 psi Filtration grade 5  $\mu\text{m}$

Filtration grade 40  $\mu\text{m}$

MSB4N- $\frac{1}{8}$

Primary pressure  $p_1 = 147$  psi

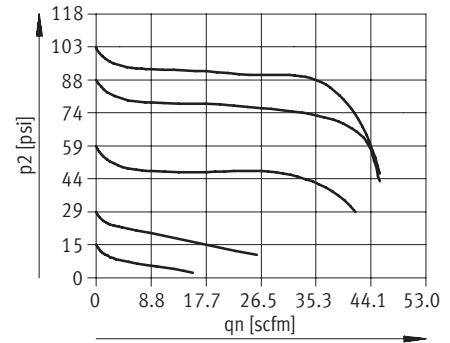
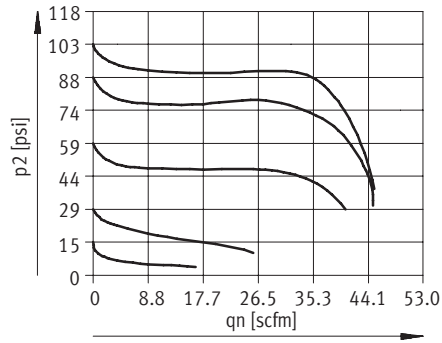

MSB4N- $\frac{1}{4}$

Primary pressure  $p_1 = 147$  psi

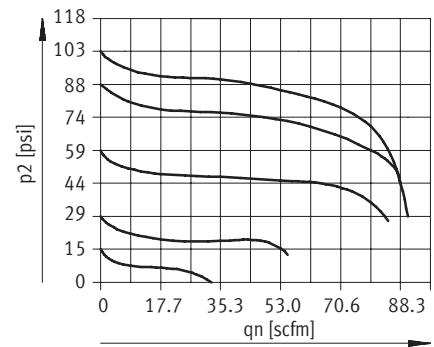
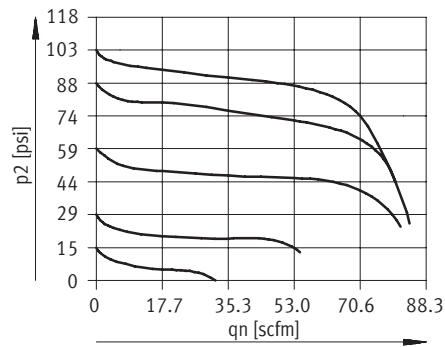

# Pre-configured Combination Units MSB4N-FRC – Inch Series



Technical Data

## Standard Flow Rate $q_n$ as a Function of Output Pressure $p_2$

Pressure regulation range 7.4 ... 176 psi Filtration grade 5  $\mu\text{m}$

Filtration grade 40  $\mu\text{m}$

MSB4N- $\frac{1}{8}$

Primary pressure  $p_1 = 147$  psi

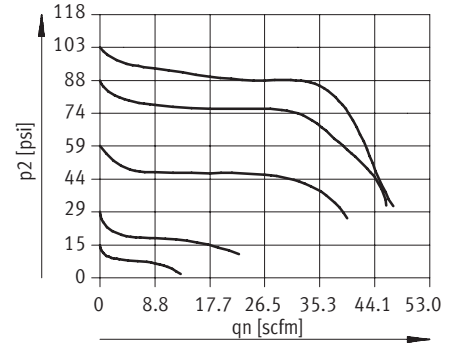
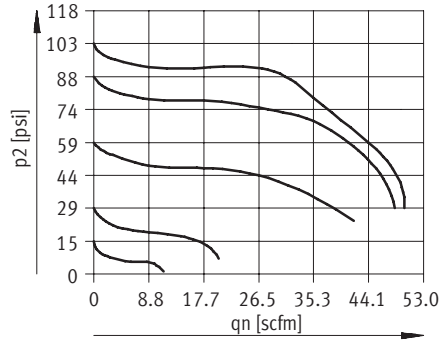

MSB4N- $\frac{1}{4}$

Primary pressure  $p_1 = 147$  psi

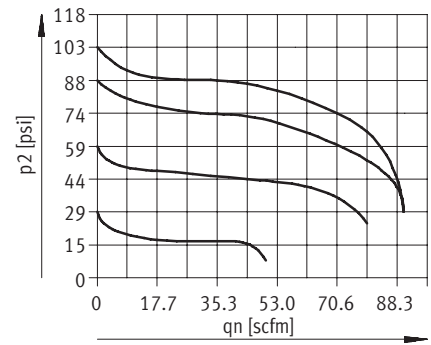
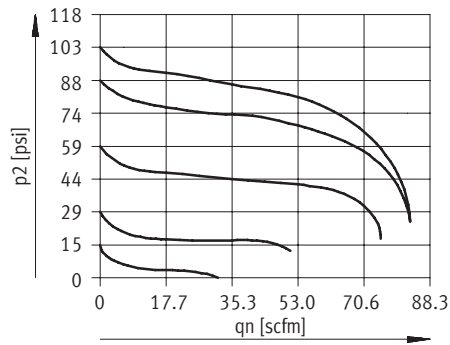

# Pre-configured Combination Units MSB4N-FRC – Inch Series

Dimensional Drawings

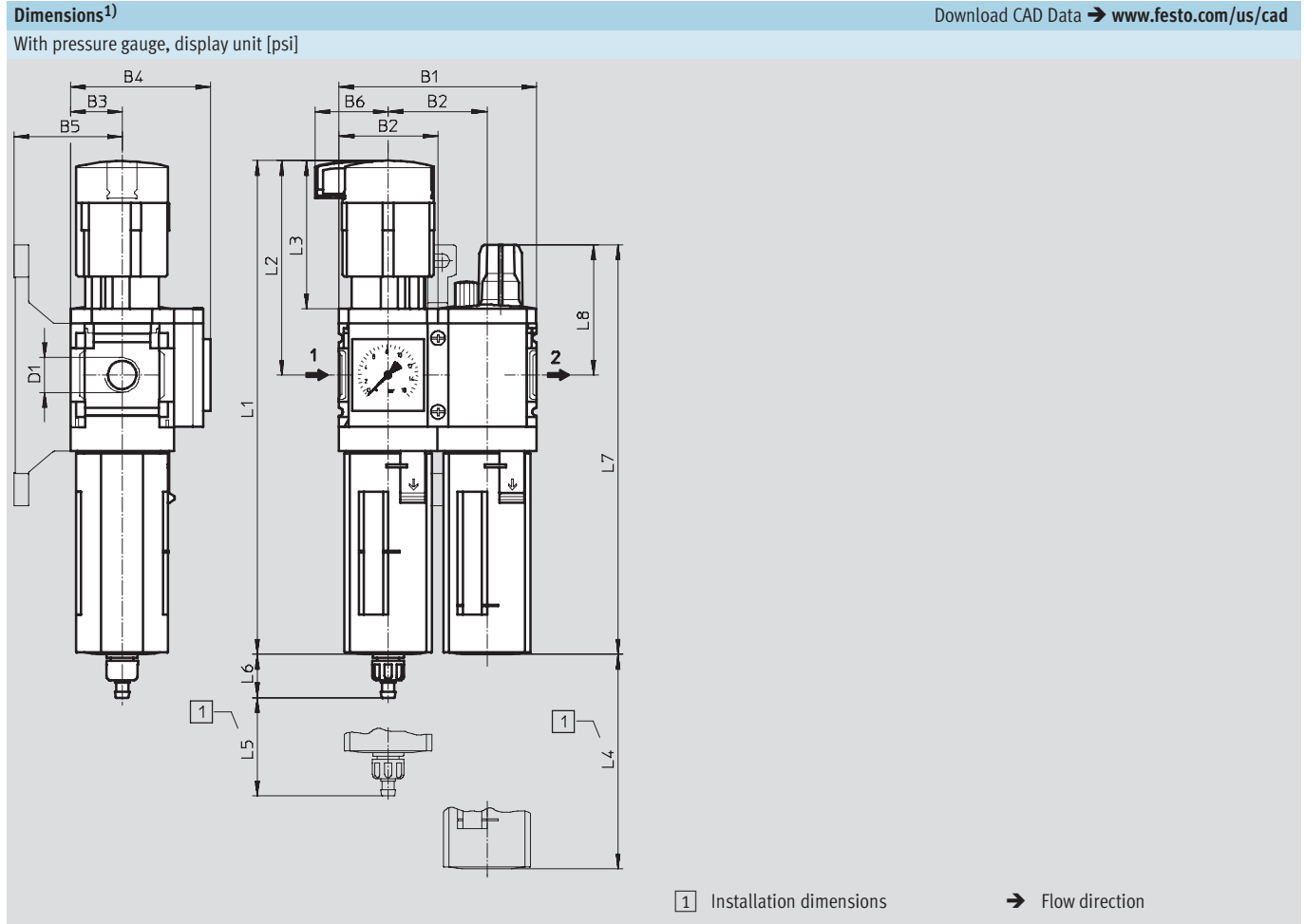

Type	B1	B2	B3	B4	B5	B6	D1	L1	L2	L3	L4	L5	L6		L7	L8
													manual	fully automatic		
MSB4N-1/8	3.17	1.58	0.83	2.24	1.73	1.17	1/8 NPT	7.91	3.43	2.36	3.15	0.98	0.7	0.8	6.57	2.09
MSB4N-1/4							1/4 NPT									

1) Dimensions are in inches, unless otherwise noted.

# Pre-configured Combination Units MSB4N-FRC – Inch Series



Ordering Data – Pre-configured Products

Ordering Data								
Pressure regulation range 4.4 ... 103 psi								
Bowl drain	Connection	Filtration grade 5 µm				Filtration grade 40 µm		
		Part No.	Type	LT	Part No.	Type	LT	
Plastic bowl guard								
Manual	1/8 NPT	533967	MSB4N-1/8-FRC3:J7M1	Q	533963	MSB4N-1/8-FRC1:J5M1	Q	
	1/4 NPT	533951	MSB4N-1/4-FRC3:J7M1	Q	533947	MSB4N-1/4-FRC1:J5M1	Q	
Fully automatic	1/8 NPT	533969	MSB4N-1/8-FRC4:J8M1	Q	533965	MSB4N-1/8-FRC2:J6M1	Q	
	1/4 NPT	533953	MSB4N-1/4-FRC4:J8M1	Q	533949	MSB4N-1/4-FRC2:J6M1	Q	

Ordering Data								
Pressure regulation range 7.4 ... 176 psi								
Bowl drain	Connection	Filtration grade 5 µm				Filtration grade 40 µm		
		Part No.	Type	LT	Part No.	Type	LT	
Plastic bowl guard								
Manual	1/8 NPT	533975	MSB4N-1/8-FRC7:J3M1	1D	533971	MSB4N-1/8-FRC5:J1M1	1D	
	1/4 NPT	533959	MSB4N-1/4-FRC7:J3M1	1W	533955	MSB4N-1/4-FRC5:J1M1	1W	
Fully automatic	1/8 NPT	533977	MSB4N-1/8-FRC8:J4M1	1D	533973	MSB4N-1/8-FRC6:J2M1	1D	
	1/4 NPT	533961	MSB4N-1/4-FRC8:J4M1	1W	533957	MSB4N-1/4-FRC6:J2M1	1W	

LT = Lead time      1D typically ships same day/next day      1W typically ships within 1 week      Q request a quote for lead time

# Pre-configured Combination Unit 1 – Inch Series

Technical Data

ISO Symbol

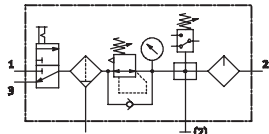

With manual bowl drain

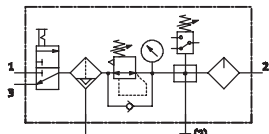

With fully automatic bowl drain

- For filtered and lubricated compressed air
- Supply pressure can be opened and closed
- Output pressure is infinitely adjustable within the pressure regulation range
- The unit is vented when switched off
- Electrical pressure monitoring with adjustable switching pressure
- Removal of filtered and unlubricated compressed air at the Distribution block connections



This combination consists of:

- On-off valve MS...-EM1 manually actuated
- Filter regulator MS...-LFR-D7
- Distribution block MS...-FRM-Y with pressure switch, without display
- Lubricator MS...-LOE-R
- Mounting bracket MS...-WP

General Technical Data	
Pneumatic connection 1, 2, 3	1/4 NPT
Regulating function	With primary pressure compensation
	With return flow function
	With secondary venting
	Output pressure constant
Type of mounting	Via accessories
Assembly position	Vertical ±5°
Filtration grade [µm]	5 (air purity class at the output 3.7.- to DIN ISO 8573-1)
	40 (air purity class at the output 5.7.- to DIN ISO 8573-1)
Bowl guard	Plastic bowl guard
Bowl drain	Manual
	Fully automatic
Pressure adjustment	Rotary knob with detent
	Lockable with accessories
Pressure regulation range [psi]	15 ... 176
Pressure indicator	With pressure gauge

Standard Nominal Flow Rate qnN [scfm]		
Filtration grade	5 µm	31.8
	40 µm	33.5



# Pre-configured Combination Unit 1 – Inch Series

Technical Data

Operating and Environmental Conditions		
Bowl drain	Manual	Fully automatic
Supply pressure [psi]	22 ... 206	22 ... 176
Operating medium	Filtered compressed air, lubricated or unlubricated, filtration grade 40 µm	
Ambient temperature [°F]	14 ... 140	41 ... 140
Temperature of medium [°F]	14 ... 140	41 ... 140
Storage temperature [°F]	14 ... 140	14 ... 140
Corrosion resistance CRC <sup>1)</sup>	2	

1) Corrosion resistance class 2 according to Festo standard 940 070  
 Components requiring moderate corrosion resistance. Externally visible parts with primarily decorative surface requirements which are in direct contact with a normal industrial environment or media such as coolants or lubricating agents.

Weights [lb]	
Service unit combination	3.40
Mounting bracket	0.08

- For spare parts go to: [www.festo.com/en/spare\\_parts\\_service](http://www.festo.com/en/spare_parts_service)

## Standard Flow Rate qn as a Function of Output Pressure p2

Pressure regulation range 15 ... 176 psi      Filtration grade 5 µm      Filtration grade 40 µm  
 MSB4N-¼

Primary pressure p1 = 147 psi

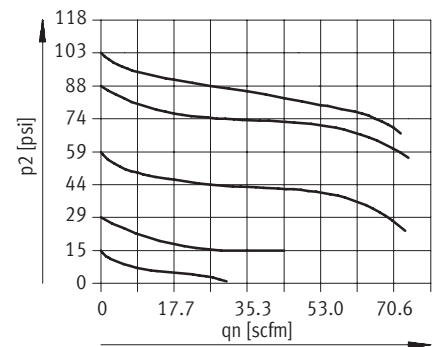
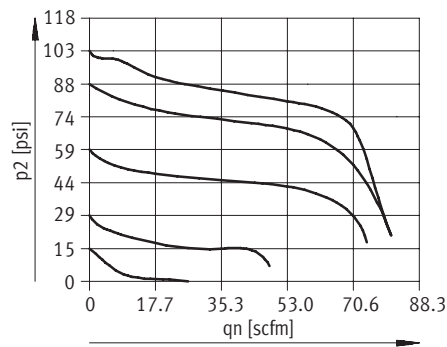

# Pre-configured Combination Unit 1 – Inch Series

Dimensional Drawings, Ordering Data – Pre-configured Products

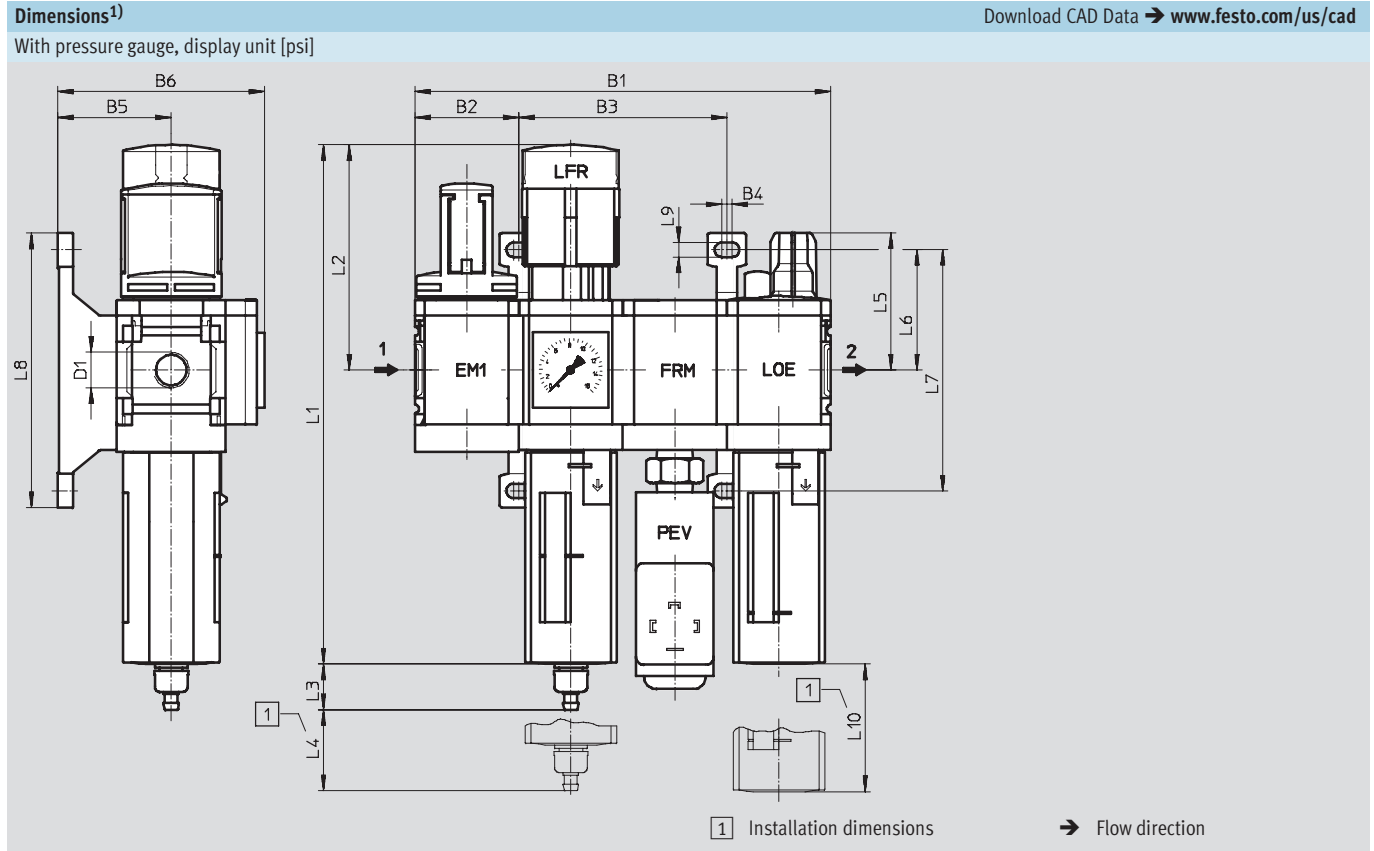

B1	B2	B3	B4	B5	B6	D1	L1	L2
6.33	1.58	3.17	0.16	1.73	3.15	¼ NPT	7.91	3.43

L3 Bowl drain		L4	L5	L6	L7	L8	L9	L10
manual	fully automatic							
0.70	0.80	0.98	2.09	1.83	3.67	4.17	0.22	3.15

1) Dimensions are in inches, unless otherwise noted.

Ordering Data									
Pressure regulation range 15... 176 psi									
Bowl drain	Connection	Filtration grade 5 µm				Filtration grade 40 µm			
		Part No.	Type	LT	Part No.	Type	LT		
Plastic bowl guard									
Manual	¼ NPT	543561	MSB4N-¼:C3J3F3M1-WP	Q	543549	MSB4N-¼:C3J1F3M1-WP	Q		
Fully automatic	¼ NPT	543567	MSB4N-¼:C3J4F3M1-WP	Q	543555	MSB4N-¼:C3J2F3M1-WP	Q		

LT = Lead time      1D typically ships same day/next day      1W typically ships within 1 week      Q request a quote for lead time

# Pre-configured Combination Unit 2 – Inch Series

Technical Data

ISO Symbol

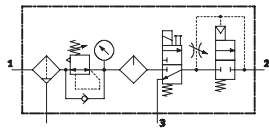

With manual bowl drain

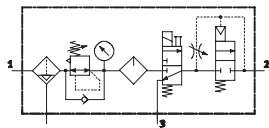

With fully automatic bowl drain

- For filtered and lubricated compressed air
- Output pressure is infinitely adjustable within the pressure regulation range
- Gradual pressure build-up prevents sudden, unpredictable movements
- When supply pressure is closed, quick venting ensures rapid pressure reduction



This combination consists of:

- Filter regulator MS...-LFR-D7
- Lubricator MS...-LOE-R
- On-off valve MS...-EE-10V24 or MS...-EE-V24 solenoid actuated
- Soft-start valve MS...-DL pneumatically actuated
- Mounting bracket MS...-WP

General Technical Data		
Pneumatic connection 1, 2, 3		1/4 NPT
Regulating function		With primary pressure compensation
		With return flow function
		With secondary venting
		Output pressure constant
Type of mounting		Via accessories
Assembly position		Vertical ±5°
Filtration grade	[µm]	5 (air purity class at the output 3.7.- to DIN ISO 8573-1)
		40 (air purity class at the output 5.7.- to DIN ISO 8573-1)
Bowl guard		Plastic bowl guard
Bowl drain		Manual
		Fully automatic
Pressure adjustment		Rotary knob with detent
		Lockable with accessories
Pressure regulation range	[psi]	59 ... 132 (with on-off valve MS...-EE-10V24)
	[psi]	59 ... 176 (with on-off valve MS...-EE-V24)
Pressure indicator		With pressure gauge
Coil characteristics	[V DC]	12
Supply voltage	[V DC]	24

Standard Nominal Flow Rate qnN [scfm]		
Filtration grade	5 µm	19.4
	40 µm	21.2

# Pre-configured Combination Unit 2 – Inch Series

Technical Data

Operating and Environmental Conditions				
	Pressure regulation range 59 ... 132 psi		Pressure regulation range 59 ... 176 psi	
Bowl drain	Manual	Fully automatic	Manual	Fully automatic
Supply pressure [psi]	66 ... 147	66 ... 147	66 ... 206	66 ... 176
Operating medium	Filtered compressed air, lubricated or unlubricated, filtration grade 40 µm			
Ambient temperature [°F]	14 ... 122	41 ... 122	14 ... 140	41 ... 140
Temperature of medium [°F]	14 ... 122	41 ... 122	14 ... 140	41 ... 140
Storage temperature [°F]	14 ... 140	14 ... 140	14 ... 140	14 ... 140
Corrosion resistance CRC <sup>1)</sup>	2			

1) Corrosion resistance class 2 according to Festo standard 940 070  
 Components requiring moderate corrosion resistance. Externally visible parts with primarily decorative surface requirements which are in direct contact with a normal industrial environment or media such as coolants or lubricating agents.

Weights [lb]	
Service unit combination	3.60
Mounting bracket	0.08

- For spare parts go to: [www.festo.com/en/spare\\_parts\\_service](http://www.festo.com/en/spare_parts_service)

## Standard Flow Rate qn as a Function of Output Pressure p2

Pressure regulation range 59 ... 132 psi / 59 ... 176 psi  
 MSB4N-1/4

Primary pressure p1 = 147 psi

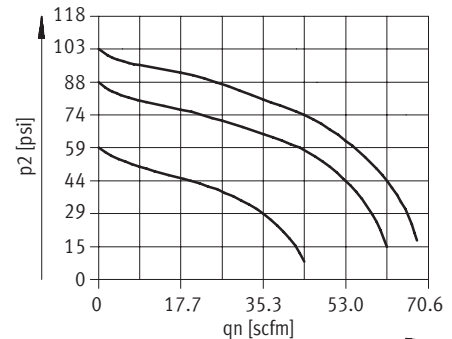
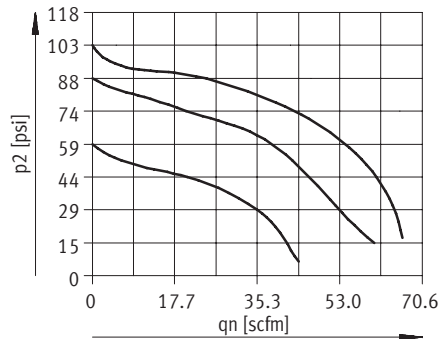

# Pre-configured Combination Unit 2 – Inch Series

Dimensional Drawings

**Dimensions<sup>1)</sup>**

Download CAD Data → [www.festo.com/us/cad](http://www.festo.com/us/cad)

With pressure gauge, display unit [psi]

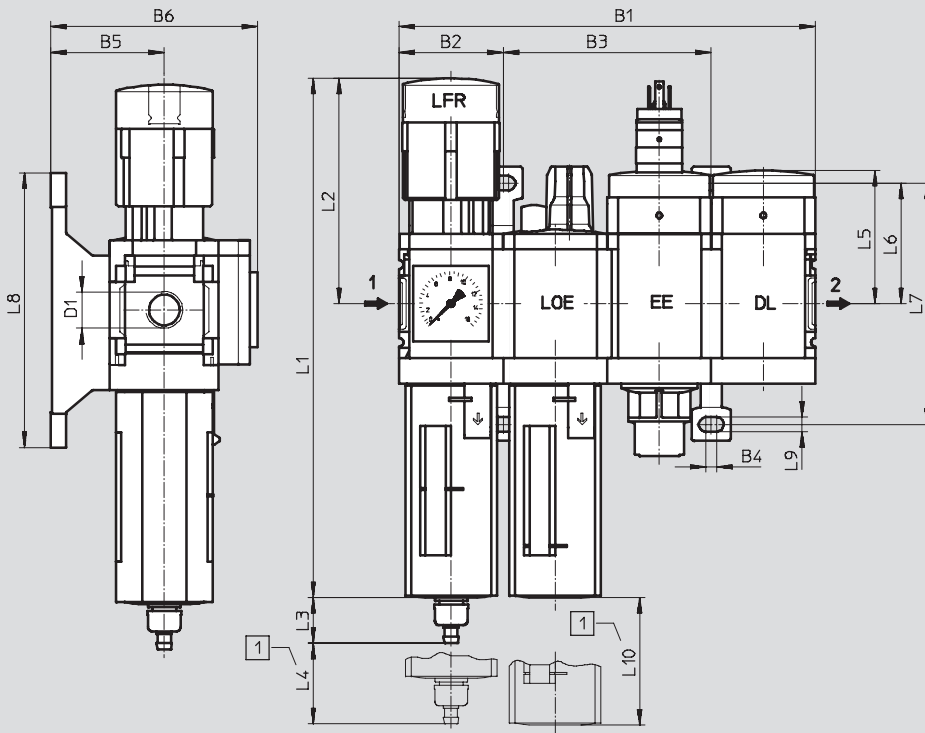

1 Installation dimensions

→ Flow direction

B1	B2	B3	B4	B5	B6	D1	L1	L2
6.33	1.58	3.17	0.16	1.73	3.15	¼ NPT	7.91	3.43

L3 Bowl drain		L4	L5	L6	L7	L8	L9	L10
manual	fully automatic							
0.70	0.80	0.98	2.04	1.83	3.67	4.17	0.22	3.15

1) Dimensions are in inches, unless otherwise noted.

## Pre-configured Combination Unit 2 – Inch Series

FESTO

Ordering Data – Pre-configured Products

Ordering Data									
Pressure regulation range 59 ... 132 psi									
Bowl drain	Connection	Filtration grade 5 µm				Filtration grade 40 µm			
		Part No.	Type	LT	Part No.	Type	LT		
Plastic bowl guard									
Manual	1/4 NPT	550496	MSB4N-1/4:J3M1D7A1-WP	Q	550492	MSB4N-1/4:J1M1D7A1-WP	Q		
Fully automatic	1/4 NPT	550498	MSB4N-1/4:J4M1D7A1-WP	Q	550494	MSB4N-1/4:J2M1D7A1-WP	Q		

Ordering Data									
Pressure regulation range 59 ... 176 psi									
Bowl drain	Connection	Filtration grade 5 µm				Filtration grade 40 µm			
		Part No.	Type	LT	Part No.	Type	LT		
Plastic bowl guard									
Manual	1/4 NPT	541440	MSB4N-1/4:J3M1D1A1-WP	1W	541436	MSB4N-1/4:J1M1D1A1-WP	Q		
Fully automatic	1/4 NPT	541442	MSB4N-1/4:J4M1D1A1-WP	1W	541438	MSB4N-1/4:J2M1D1A1-WP	1W		

LT = Lead time      1D typically ships same day/next day      1W typically ships within 1 week      Q request a quote for lead time

# Pre-configured Combination Unit 3 – Inch Series

Technical Data

ISO Symbol

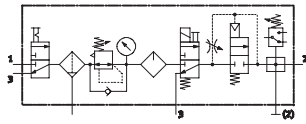

With manual bowl drain

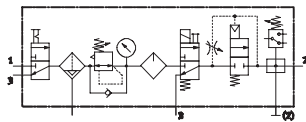

With fully automatic bowl drain

- For filtered and lubricated compressed air
- Supply pressure can be opened and closed
- Output pressure is infinitely adjustable within the pressure regulation range
- Gradual pressure build-up prevents sudden, unpredictable movements
- To shut-off and vent the following device or the system
- Electrical pressure monitoring with adjustable switching pressure



This combination consists of:

- On-off valve MS...-EM1 manually actuated
- Filter regulator MS...-LFR-D7
- Lubricator MS...-LOE-R
- On-off valve MS...-EE-10V24 or MS...-EE-V24 solenoid actuated
- Soft-start valve MS...-DL pneumatically actuated
- Distribution block MS...-FRM-Y with pressure switch, without display
- Mounting bracket MS...-WP

General Technical Data	
Pneumatic connection 1, 2, 3	1/4 NPT
Regulating function	With primary pressure compensation
	With return flow function
	With secondary venting
	Output pressure constant
Type of mounting	Via accessories
Assembly position	Vertical ±5°
Filtration grade [µm]	5 (air purity class at the output 3.7.– to DIN ISO 8573-1)
	40 (air purity class at the output 5.7.– to DIN ISO 8573-1)
Bowl guard	Plastic bowl guard
Bowl drain	Manual
	Fully automatic
Pressure adjustment	Rotary knob with detent
	Lockable with accessories
Pressure regulation range [psi]	59 ... 132 (with on-off valve MS...-EE-10V24)
	59 ... 176 (with on-off valve MS...-EE-V24)
Pressure indicator	With pressure gauge
Coil characteristics [V DC]	12
Supply voltage [V DC]	24

Standard Nominal Flow Rate qnN [scfm]		
Filtration grade	5 µm	19.4
	40 µm	21.2

# Pre-configured Combination Unit 3 – Inch Series

Technical Data



Operating and Environmental Conditions				
	Pressure regulation range 59 ... 132 psi		Pressure regulation range 59 ... 176 psi	
Bowl drain	Manual	Fully automatic	Manual	Fully automatic
Supply pressure [psi]	66 ... 147	66 ... 147	66 ... 206	66 ... 176
Operating medium	Filtered compressed air, lubricated or unlubricated, filtration grade 40 µm			
Ambient temperature [°F]	14 ... 122	41 ... 122	14 ... 140	41 ... 140
Temperature of medium [°F]	14 ... 122	41 ... 122	14 ... 140	41 ... 140
Storage temperature [°F]	14 ... 140	14 ... 140	14 ... 140	14 ... 140
Corrosion resistance	CRC <sup>1)</sup>		2	

1) Corrosion resistance class 2 according to Festo standard 940 070  
 Components requiring moderate corrosion resistance. Externally visible parts with primarily decorative surface requirements which are in direct contact with a normal industrial environment or media such as coolants or lubricating agents.

Weights [lb]	
Service unit combination	4.40
Mounting bracket	0.08

- For spare parts go to: [www.festo.com/en/spare\\_parts\\_service](http://www.festo.com/en/spare_parts_service)

## Standard Flow Rate qn as a Function of Output Pressure p2

Pressure regulation range 59 ... 132 psi / 59 ... 176 psi  
 MSB4N-¼

Primary pressure p1 = 147 psi

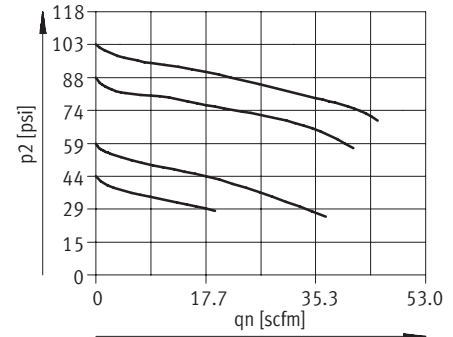
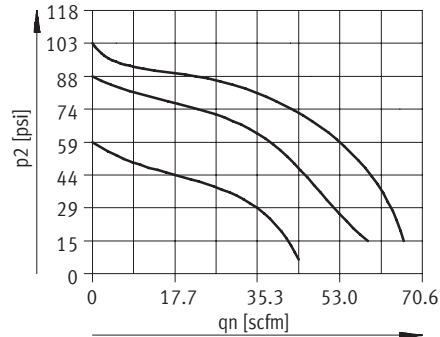



# Pre-configured Combination Unit 3 – Inch Series

Dimensional Drawings

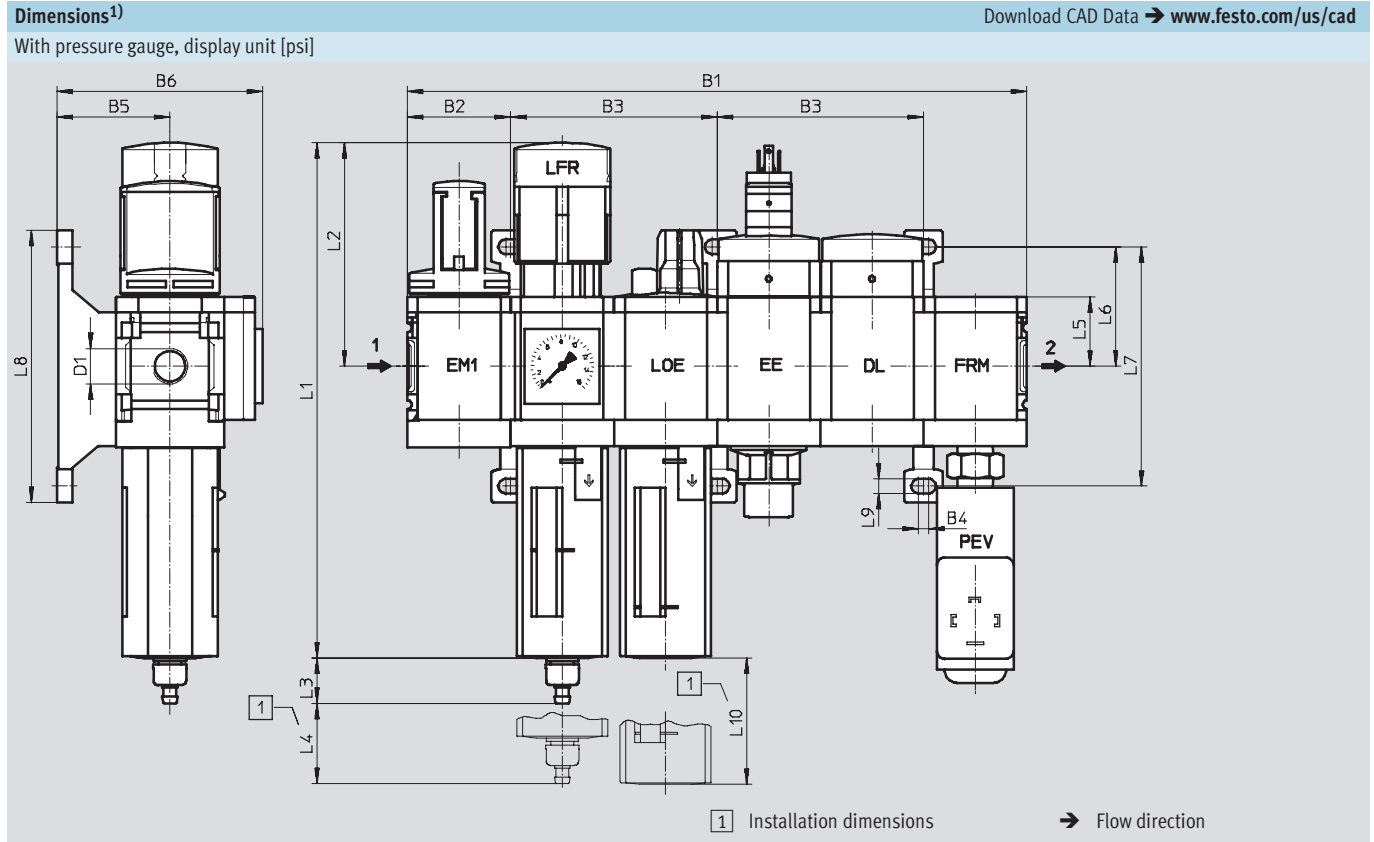

B1	B2	B3	B4	B5	B6	D1	L1	L2
9.50	1.58	3.17	0.16	1.73	3.15	¼ NPT	7.91	3.43

L3 Bowl drain		L4	L5	L6	L7	L8	L9	L10
manual	fully automatic							
0.70	0.80	0.98	1.06	1.83	3.67	4.17	0.22	3.15

1) Dimensions are in inches, unless otherwise noted.

## Pre-configured Combination Unit 3 – Inch Series

FESTO

Ordering Data – Pre-configured Products

Ordering Data									
Pressure regulation range 59 ... 132 psi									
Bowl drain	Connection	Filtration grade 5 µm				Filtration grade 40 µm			
		Part No.	Type	LT	Part No.	Type	LT		
Plastic bowl guard									
Manual	1/4 NPT	550488	MSB4N-1/4:C3J3M1D7A1F3-WP	Q	550484	MSB4N-1/4:C3J1M1D7A1F3-WP	Q		
Fully automatic	1/4 NPT	550490	MSB4N-1/4:C3J4M1D7A1F3-WP	Q	550486	MSB4N-1/4:C3J2M1D7A1F3-WP	Q		

Ordering Data									
Pressure regulation range 59 ... 176 psi									
Bowl drain	Connection	Filtration grade 5 µm				Filtration grade 40 µm			
		Part No.	Type	LT	Part No.	Type	LT		
Plastic bowl guard									
Manual	1/4 NPT	543563	MSB4N-1/4:C3J3M1D1A1F3-WP	Q	543551	MSB4N-1/4:C3J1M1D1A1F3-WP	Q		
Fully automatic	1/4 NPT	543569	MSB4N-1/4:C3J4M1D1A1F3-WP	Q	543557	MSB4N-1/4:C3J2M1D1A1F3-WP	Q		

LT = Lead time      1D typically ships same day/next day      1W typically ships within 1 week      Q request a quote for lead time

# Pre-configured Combination Unit 4 – Inch Series

Technical Data

ISO Symbol

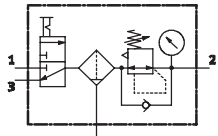

With manual bowl drain

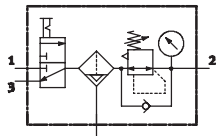

With fully automatic bowl drain

- For filtered and unlubricated compressed air
- Supply pressure can be opened and closed
- Output pressure is infinitely adjustable within the pressure regulation range



This combination consists of:

- On-off valve MS...-EM1 manually actuated
- Filter regulator MS...-LFR-D7
- Mounting bracket MS...-WP

General Technical Data	
Pneumatic connection 1, 2, 3	1/4 NPT
Regulating function	With primary pressure compensation
	With return flow function
	With secondary venting
	Output pressure constant
Type of mounting	Via accessories
Assembly position	Vertical ±5°
Filtration grade [µm]	5 (air purity class at the output 3.7.- to DIN ISO 8573-1)
	40 (air purity class at the output 5.7.- to DIN ISO 8573-1)
Bowl guard	Plastic bowl guard
Bowl drain	Manual
	Fully automatic
Pressure adjustment	Rotary knob with detent
	Lockable with accessories
Pressure regulation range [psi]	7.4 ... 176
Pressure indicator	With pressure gauge

Standard Nominal Flow Rate qnN [scfm]		
Filtration grade	5 µm	33.5
	40 µm	35.3

# Pre-configured Combination Unit 4 – Inch Series

Technical Data

Operating and Environmental Conditions		
Bowl drain	Manual	Fully automatic
Supply pressure [psi]	12 ... 206	22 ... 176
Operating medium	Filtered compressed air, lubricated or unlubricated, filtration grade 40 µm	
Ambient temperature [°F]	14 ... 140	41 ... 140
Temperature of medium [°F]	14 ... 140	41 ... 140
Storage temperature [°F]	14 ... 140	14 ... 140
Corrosion resistance CRC <sup>1)</sup>	2	

1) Corrosion resistance class 2 according to Festo standard 940 070  
 Components requiring moderate corrosion resistance. Externally visible parts with primarily decorative surface requirements which are in direct contact with a normal industrial environment or media such as coolants or lubricating agents.

Weights [lb]	
Service unit combination	2.60
Mounting bracket	0.08

- For spare parts go to: [www.festo.com/en/spare\\_parts\\_service](http://www.festo.com/en/spare_parts_service)

## Standard Flow Rate qn as a Function of Output Pressure p2

Pressure regulation range 7.4 ... 176 psi      Filtration grade 5 µm      Filtration grade 40 µm  
 MSB4N-¼

Primary pressure p1 = 147 psi

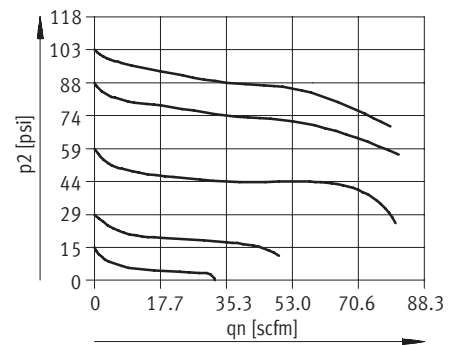
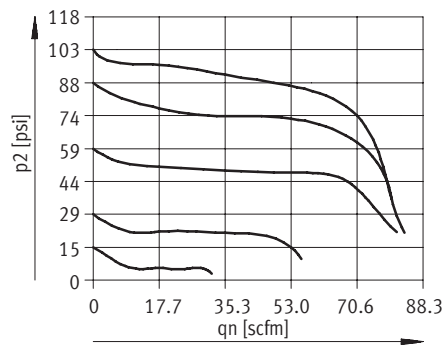

# Pre-configured Combination Unit 4 – Inch Series

Dimensional Drawings, Ordering Data – Pre-configured Products

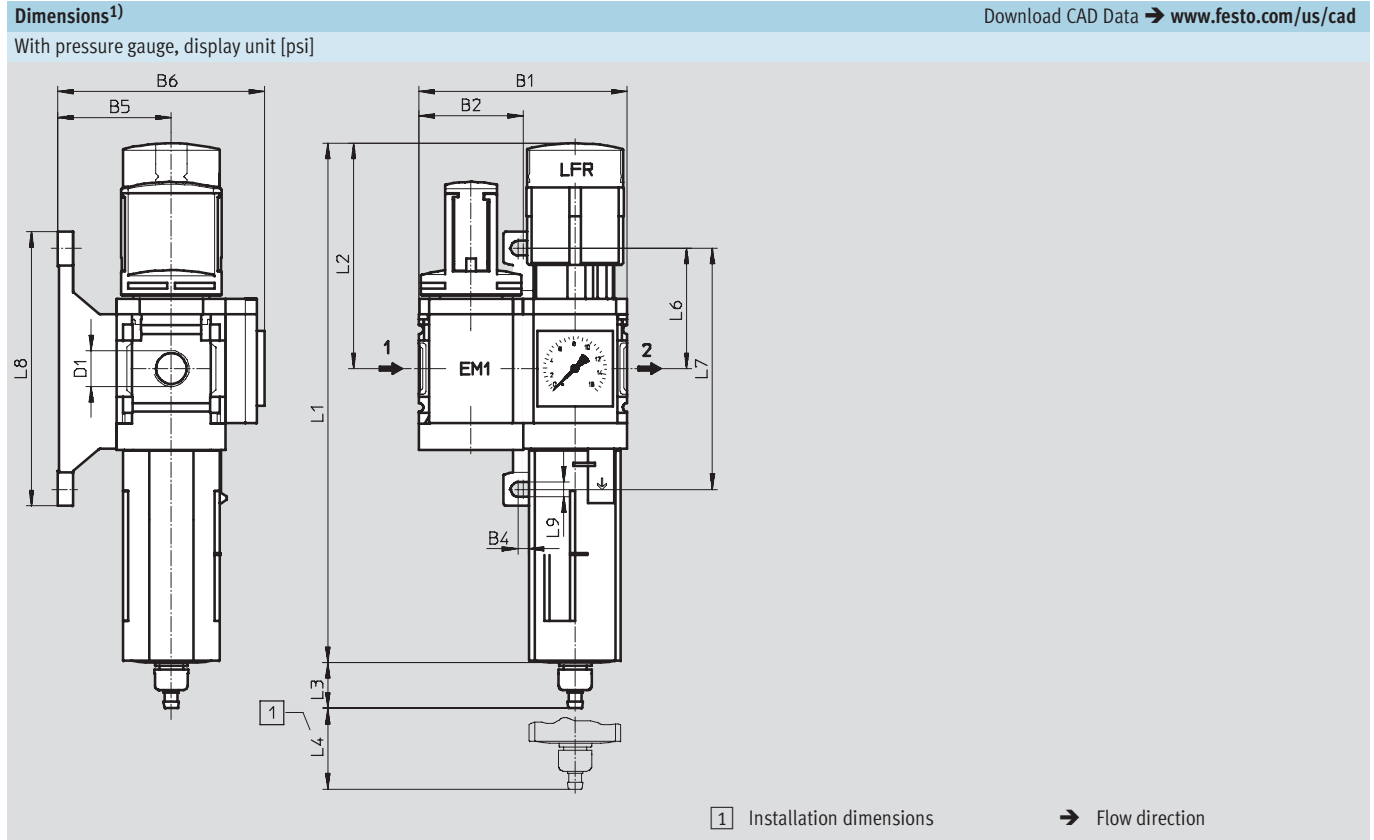

B1	B2	B4	B5	B6	D1	L1	L2
3.17	1.58	0.16	1.73	3.15	¼ NPT	7.91	3.43

L3 Bowl drain		L4	L6	L7	L8	L9
manual	fully automatic					
0.70	0.80	0.98	1.83	3.67	4.17	0.22

1) Dimensions are in inches, unless otherwise noted.

Ordering Data							
Pressure regulation range 7.4 ... 176 psi							
Bowl drain	Connection	Filtration grade 5 µm			Filtration grade 40 µm		
		Part No.	Type	LT	Part No.	Type	LT
Plastic bowl guard							
Manual	¼ NPT	543565	MSB4N-¼:C3J3-WP	Q	543553	MSB4N-¼:C3J1-WP	Q
Fully automatic	¼ NPT	543571	MSB4N-¼:C3J4-WP	Q	543559	MSB4N-¼:C3J2-WP	Q

LT = Lead time      1D typically ships same day/next day      1W typically ships within 1 week      Q request a quote for lead time

# Pre-configured Combination Unit 5 – Inch Series

Technical Data

ISO Symbol

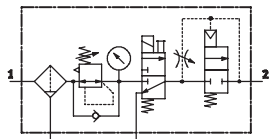

With manual bowl drain

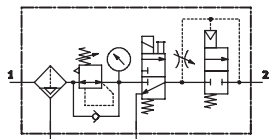

With fully automatic bowl drain

- For filtered and unlubricated compressed air
- Output pressure is infinitely adjustable within the pressure regulation range
- Gradual pressure build-up prevents sudden, unpredictable movements
- When supply pressure is closed, quick venting ensures rapid pressure reduction



This combination consists of:

- Filter regulator MS...-LFR-D7
- On-off valve MS...-EE-10V24 or MS...-EE-V24 solenoid actuated
- Soft-start valve MS...-DL pneumatically actuated
- Mounting bracket MS...-WP

General Technical Data	
Pneumatic connection 1, 2, 3	1/4 NPT
Regulating function	With primary pressure compensation
	With return flow function
	With secondary venting
	Output pressure constant
Type of mounting	Via accessories
Assembly position	Vertical ±5°
Filtration grade [µm]	5 (air purity class at the output 3.7.- to DIN ISO 8573-1)
	40 (air purity class at the output 5.7.- to DIN ISO 8573-1)
Bowl guard	Plastic bowl guard
Bowl drain	Manual
	Fully automatic
Pressure adjustment	Rotary knob with detent
	Lockable with accessories
Pressure regulation range [psi]	59 ... 132 (with on-off valve MS...-EE-10V24)
	59 ... 176 (with on-off valve MS...-EE-V24)
Pressure indicator	With pressure gauge
Coil characteristics [V DC]	12
Supply voltage [V DC]	24

Standard Nominal Flow Rate qnN [scfm]		
Filtration grade	5 µm	24.7
	40 µm	26.5

# Pre-configured Combination Unit 5 – Inch Series

Technical Data



Operating and Environmental Conditions				
	Pressure regulation range 59 ... 132 psi		Pressure regulation range 59 ... 176 psi	
Bowl drain	Manual	Fully automatic	Manual	Fully automatic
Supply pressure [psi]	66 ... 147	66 ... 147	66 ... 206	66 ... 176
Operating medium	Filtered compressed air, lubricated or unlubricated, filtration grade 40 µm			
Ambient temperature [°F]	14 ... 122	41 ... 122	14 ... 140	41 ... 140
Temperature of medium [°F]	14 ... 122	41 ... 122	14 ... 140	41 ... 140
Storage temperature [°F]	14 ... 140	14 ... 140	14 ... 140	14 ... 140
Corrosion resistance	CRC <sup>1)</sup> 2			

1) Corrosion resistance class 2 according to Festo standard 940 070  
 Components requiring moderate corrosion resistance. Externally visible parts with primarily decorative surface requirements which are in direct contact with a normal industrial environment or media such as coolants or lubricating agents.

Weights [lb]	
Service unit combination	3.20
Mounting bracket	0.08

- For spare parts go to: [www.festo.com/en/spare\\_parts\\_service](http://www.festo.com/en/spare_parts_service)

## Standard Flow Rate $q_n$ as a Function of Output Pressure $p_2$

Pressure regulation range 59 ... 132 psi / 59 ... 176 psi  
 MSB4N-1/4

Primary pressure  $p_1 = 147$  psi

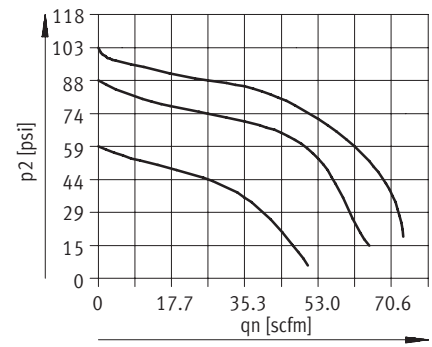
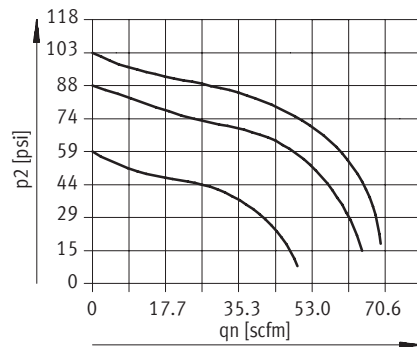

# Pre-configured Combination Unit 5 – Inch Series

Dimensional Drawings



## Dimensions<sup>1)</sup>

Download CAD Data → [www.festo.com/us/cad](http://www.festo.com/us/cad)

With pressure gauge, display unit [psi]

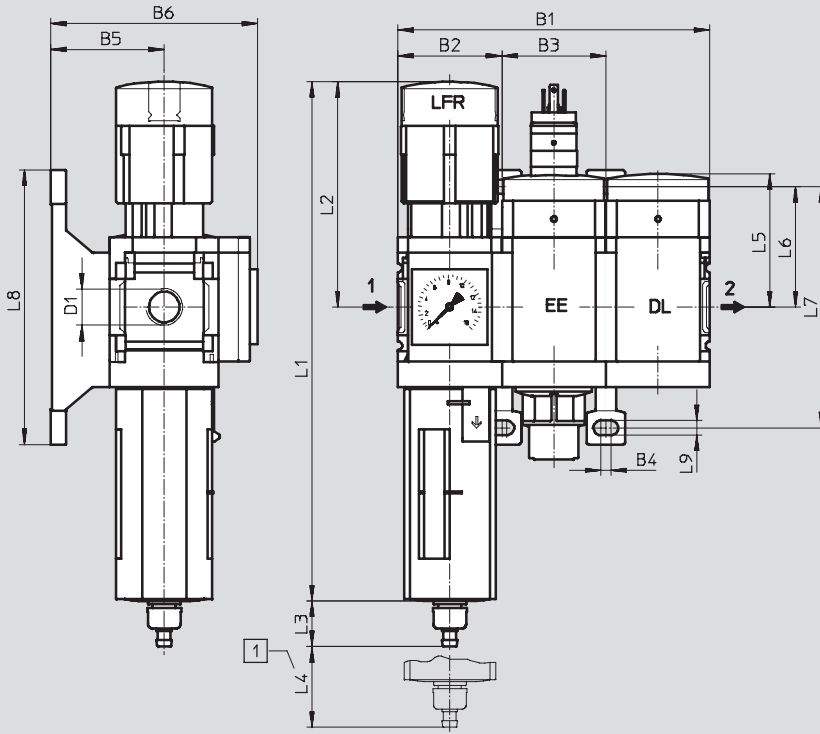

1 Installation dimensions

→ Flow direction

B1	B2	B3	B4	B5	B6	D1	L1	L2
4.75	1.58	1.58	0.16	1.73	3.15	¼ NPT	7.91	3.43

L3 Bowl drain		L4	L5	L6	L7	L8	L9
manual	fully automatic						
0.70	0.80	0.98	2.04	1.83	3.67	4.17	0.22

1) Dimensions are in inches, unless otherwise noted.



# Pre-configured Combination Unit 5 – Inch Series



Ordering Data – Pre-configured Products

Ordering Data									
Pressure regulation range 59 ... 132 psi									
Bowl drain	Connection	Filtration grade 5 µm				Filtration grade 40 µm			
		Part No.	Type	LT	Part No.	Type	LT		
Plastic bowl guard									
Manual	1/4 NPT	550495	MSB4N-1/4:J3D7A1-WP	Q	550491	MSB4N-1/4:J1D7A1-WP	Q		
Fully automatic	1/4 NPT	550497	MSB4N-1/4:J4D7A1-WP	Q	550493	MSB4N-1/4:J2D7A1-WP	Q		

Ordering Data									
Pressure regulation range 59 ... 176 psi									
Bowl drain	Connection	Filtration grade 5 µm				Filtration grade 40 µm			
		Part No.	Type	LT	Part No.	Type	LT		
Plastic bowl guard									
Manual	1/4 NPT	541439	MSB4N-1/4:J3D1A1-WP	1W	541435	MSB4N-1/4:J1D1A1-WP	1W		
Fully automatic	1/4 NPT	541441	MSB4N-1/4:J4D1A1-WP	1W	541437	MSB4N-1/4:J2D1A1-WP	1W		

LT = Lead time      1D typically ships same day/next day      1W typically ships within 1 week      Q request a quote for lead time

# Pre-configured Combination Unit 6 – Inch Series

Technical Data

ISO Symbol

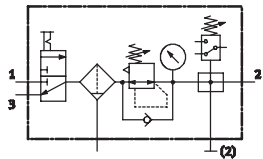

With manual bowl drain

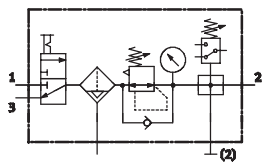

With fully automatic bowl drain

- For filtered and unlubricated compressed air
- Supply pressure can be opened and closed
- Output pressure is infinitely adjustable within the pressure regulation range
- Electrical pressure monitoring with adjustable switching pressure



This combination consists of:

- On-off valve MS...-EM1 manually actuated
- Filter regulator MS...-LFR-D7
- Distribution block MS...-FRM-Y with pressure switch, without display
- Mounting bracket MS...-WP

General Technical Data	
Pneumatic connection 1, 2, 3	1/4 NPT
Regulating function	With primary pressure compensation
	With return flow function
	With secondary venting
	Output pressure constant
Type of mounting	Via accessories
Assembly position	Vertical ±5°
Filtration grade [µm]	5 (air purity class at the output 3.7.- to DIN ISO 8573-1)
	40 (air purity class at the output 5.7.- to DIN ISO 8573-1)
Bowl guard	Plastic bowl guard
Bowl drain	Manual
	Fully automatic
Pressure adjustment	Rotary knob with detent
	Lockable with accessories
Pressure regulation range [psi]	7.4 ... 176
Pressure indicator	With pressure gauge

Standard Nominal Flow Rate qnN [scfm]		
Filtration grade	5 µm	44.1
	40 µm	45.9

# Pre-configured Combination Unit 6 – Inch Series

Technical Data



Operating and Environmental Conditions		
Bowl drain	Manual	Fully automatic
Supply pressure [psi]	12 ... 206	22 ... 176
Operating medium	Filtered compressed air, lubricated or unlubricated, filtration grade 40 µm	
Ambient temperature [°F]	14 ... 140	41 ... 140
Temperature of medium [°F]	14 ... 140	41 ... 140
Storage temperature [°F]	14 ... 140	14 ... 140
Corrosion resistance CRC <sup>1)</sup>	2	

1) Corrosion resistance class 2 according to Festo standard 940 070  
 Components requiring moderate corrosion resistance. Externally visible parts with primarily decorative surface requirements which are in direct contact with a normal industrial environment or media such as coolants or lubricating agents.

Weights [lb]	
Service unit combination	3.00
Mounting bracket	0.08

- For spare parts go to: [www.festo.com/en/spare\\_parts\\_service](http://www.festo.com/en/spare_parts_service)

## Standard Flow Rate qn as a Function of Output Pressure p2

Pressure regulation range 7.4 ... 176 psi    Filtration grade 5 µm    Filtration grade 40 µm  
 MSB4N-¼

Primary pressure p1 = 147 psi

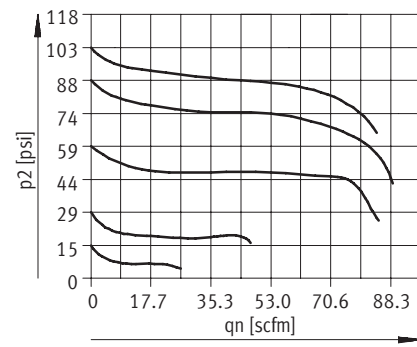
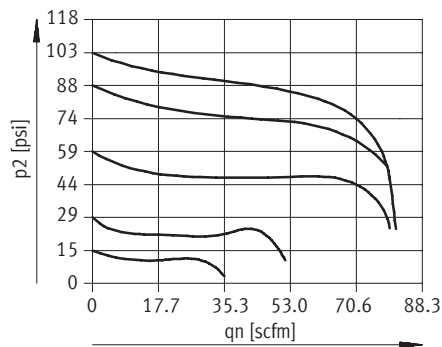

# Pre-configured Combination Unit 6 – Inch Series

Dimensional Drawings, Ordering Data – Pre-configured Products

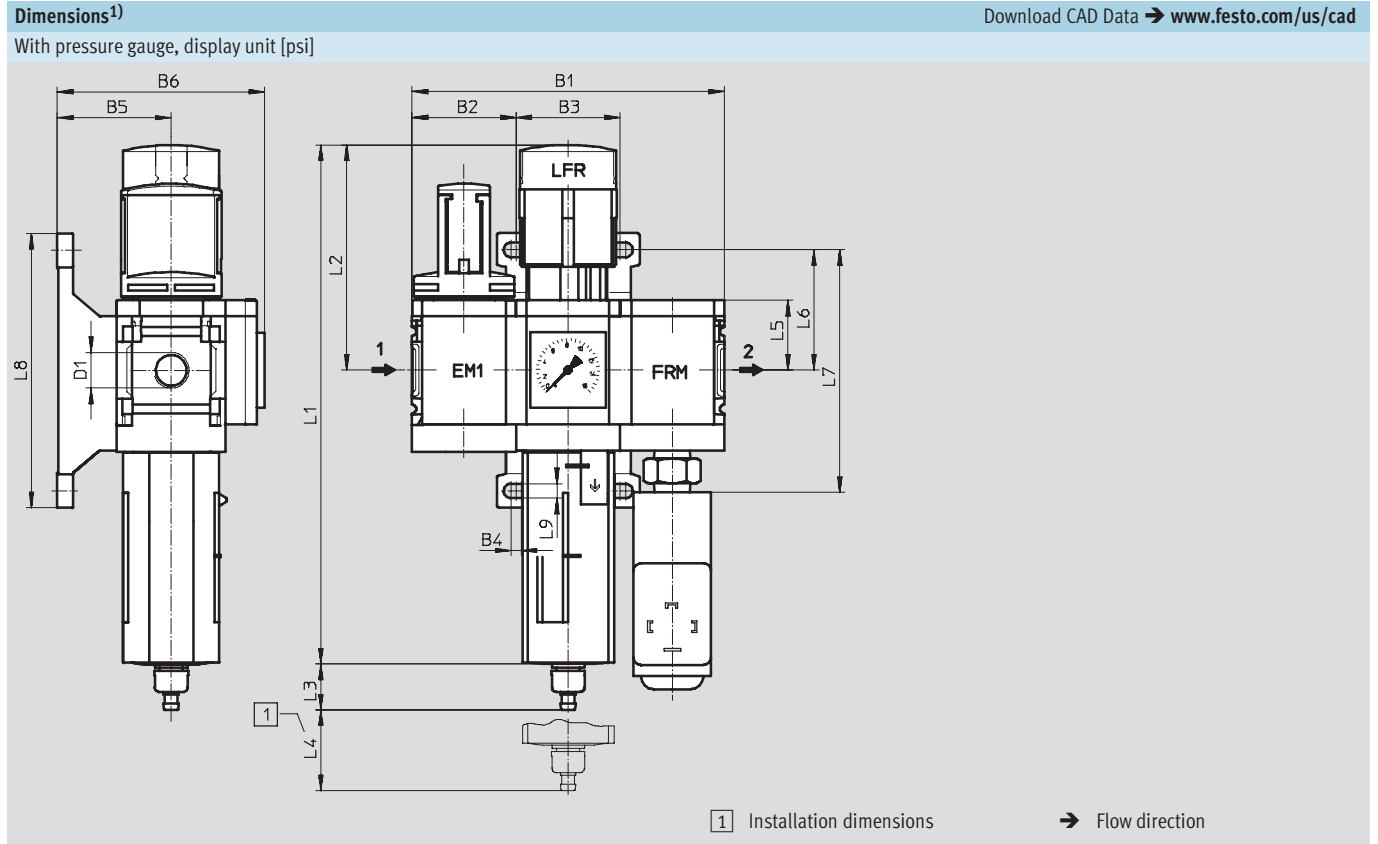

B1	B2	B3	B4	B5	B6	D1	L1	L2
4.75	1.58	1.58	0.16	1.73	3.15	¼ NPT	7.91	3.43

L3 Bowl drain		L4	L5	L6	L7	L8	L9
manual	fully automatic						
0.70	0.80	0.98	1.06	1.83	3.69	4.17	0.22

1) Dimensions are in inches, unless otherwise noted.

Ordering Data								
Pressure regulation range 7.4 ... 176 psi								
Bowl drain	Connection	Filtration grade 5 µm				Filtration grade 40 µm		
		Part No.	Type	LT	Part No.	Type	LT	
Plastic bowl guard								
Manual	¼ NPT	543562	MSB4N-¼:C3J3F3-WP	Q	543550	MSB4N-¼:C3J1F3-WP	Q	
Fully automatic	¼ NPT	543568	MSB4N-¼:C3J4F3-WP	Q	543556	MSB4N-¼:C3J2F3-WP	Q	

LT = Lead time      1D typically ships same day/next day      1W typically ships within 1 week      Q request a quote for lead time

# Pre-configured Combination Unit 7 – Inch Series

Technical Data

ISO Symbol

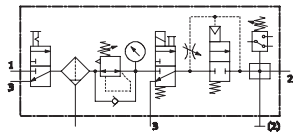

With manual bowl drain

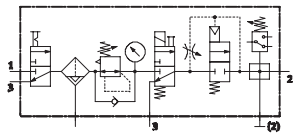

With fully automatic bowl drain

- For filtered and unlubricated compressed air
- Supply pressure can be opened and closed
- Output pressure is infinitely adjustable within the pressure regulation range
- Gradual pressure build-up prevents sudden, unpredictable movements
- To shut-off and vent the following device or the system
- Electrical pressure monitoring with adjustable switching pressure



This combination consists of:

- On-off valve MS...-EM1 manually actuated
- Filter regulator MS...-LFR-D7
- On-off valve MS...-EE-10V24 or MS...-EE-V24 solenoid actuated
- Soft-start valve MS...-DL pneumatically actuated
- Distribution block MS...-FRM-Y with pressure switch, without display
- Mounting bracket MS...-WP

General Technical Data	
Pneumatic connection 1, 2, 3	1/4 NPT
Regulating function	With primary pressure compensation
	With return flow function
	With secondary venting
	Output pressure constant
Type of mounting	Via accessories
Assembly position	Vertical ±5°
Filtration grade [µm]	5 (air purity class at the output 3.7.– to DIN ISO 8573-1)
	40 (air purity class at the output 5.7.– to DIN ISO 8573-1)
Bowl guard	Plastic bowl guard
Bowl drain	Manual
	Fully automatic
Pressure adjustment	Rotary knob with detent
	Lockable with accessories
Pressure regulation range [psi]	59 ... 132 (with on-off valve MS...-EE-10V24)
	59 ... 176 (with on-off valve MS...-EE-V24)
Pressure indicator	With pressure gauge
Coil characteristics [V DC]	12
Supply voltage [V DC]	24

Standard Nominal Flow Rate qnN [scfm]		
Filtration grade	5 µm	24.7
	40 µm	26.5

# Pre-configured Combination Unit 7 – Inch Series

Technical Data

Operating and Environmental Conditions				
	Pressure regulation range 59 ... 132 psi		Pressure regulation range 59 ... 176 psi	
Bowl drain	Manual	Fully automatic	Manual	Fully automatic
Supply pressure [psi]	66 ... 147	66 ... 147	66 ... 206	66 ... 176
Operating medium	Filtered compressed air, lubricated or unlubricated, filtration grade 40 µm			
Ambient temperature [°F]	14 ... 122	41 ... 122	14 ... 140	41 ... 140
Temperature of medium [°F]	14 ... 122	41 ... 122	14 ... 140	41 ... 140
Storage temperature [°F]	14 ... 140	14 ... 140	14 ... 140	14 ... 140
Corrosion resistance	CRC <sup>1)</sup> 2			

1) Corrosion resistance class 2 according to Festo standard 940 070  
 Components requiring moderate corrosion resistance. Externally visible parts with primarily decorative surface requirements which are in direct contact with a normal industrial environment or media such as coolants or lubricating agents.

Weights [lb]	
Service unit combination	4.40
Mounting bracket	0.08

- For spare parts go to: [www.festo.com/en/spare\\_parts\\_service](http://www.festo.com/en/spare_parts_service)

## Standard Flow Rate qn as a Function of Output Pressure p2

Pressure regulation range 59 ... 132 psi / 59 ... 176 psi  
 MSB4N-1/4

Primary pressure p1 = 147 psi

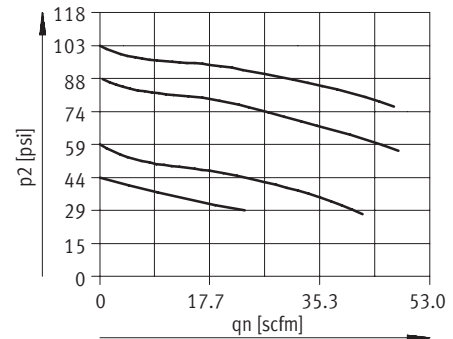
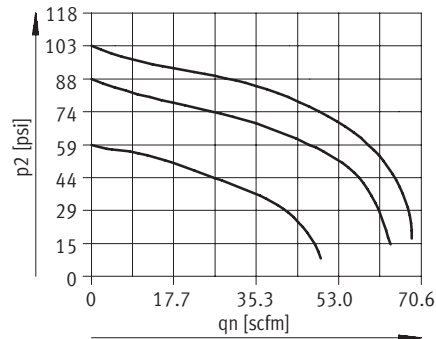

# Pre-configured Combination Unit 7 – Inch Series

Dimensional Drawings

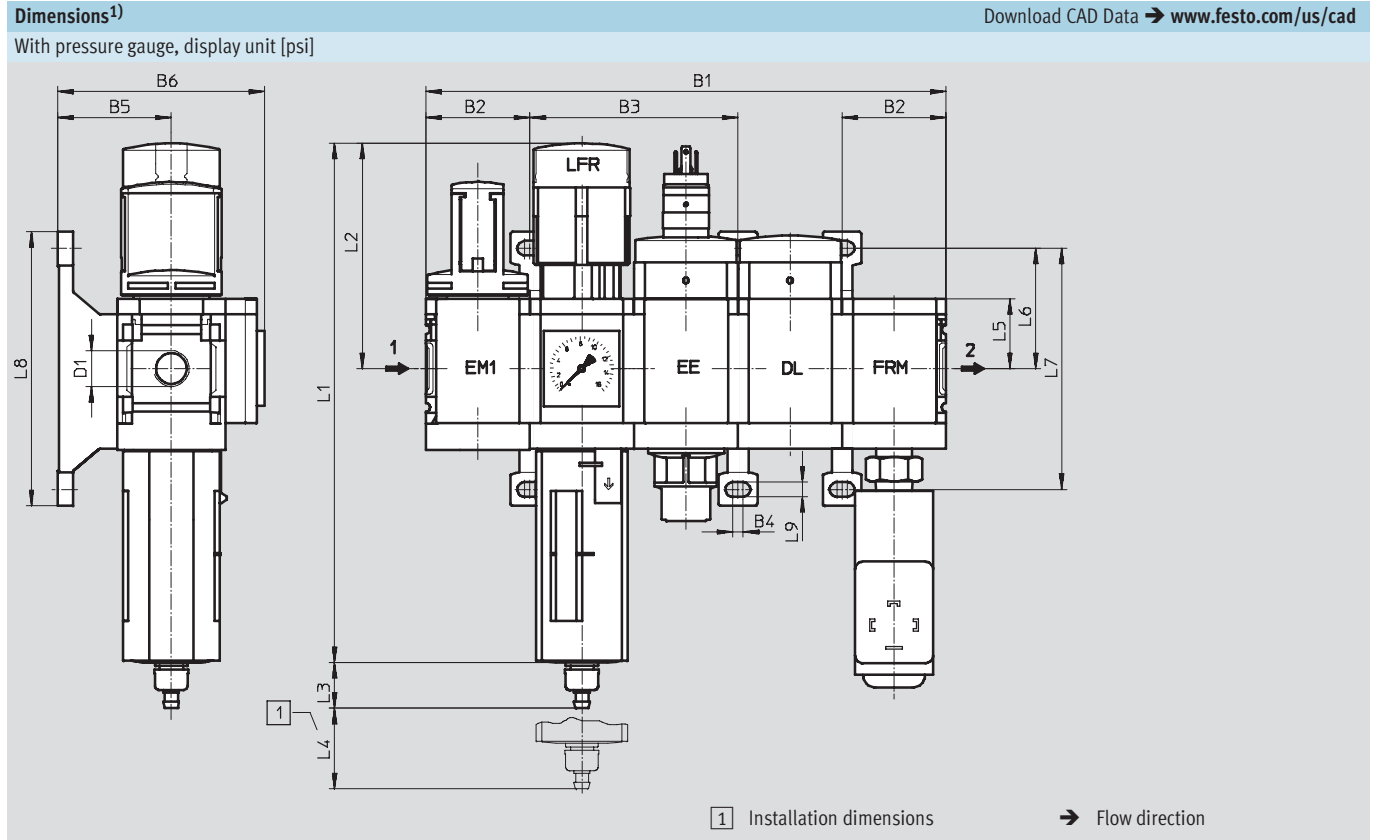

B1	B2	B3	B4	B5	B6	D1	L1	L2
7.91	1.58	3.17	0.16	1.73	3.15	¼ NPT	7.91	3.43

L3 Bowl drain		L4	L5	L6	L7	L8	L9
manual	fully automatic						
0.70	0.80	0.98	1.06	1.83	3.67	4.17	0.22

1) Dimensions are in inches, unless otherwise noted.

# Pre-configured Combination Unit 7 – Inch Series



Ordering Data – Pre-configured Products

Ordering Data									
Pressure regulation range 59 ... 132 psi									
Bowl drain	Connection	Filtration grade 5 µm				Filtration grade 40 µm			
		Part No.	Type	LT	Part No.	Type	LT		
Plastic bowl guard									
Manual	1/4 NPT	550487	MSB4N-1/4:C3J3D7A1F3-WP	Q	550483	MSB4N-1/4:C3J1D7A1F3-WP	Q		
Fully automatic	1/4 NPT	550489	MSB4N-1/4:C3J4D7A1F3-WP	Q	550485	MSB4N-1/4:C3J2D7A1F3-WP	Q		

Ordering Data									
Pressure regulation range 59 ... 176 psi									
Bowl drain	Connection	Filtration grade 5 µm				Filtration grade 40 µm			
		Part No.	Type	LT	Part No.	Type	LT		
Plastic bowl guard									
Manual	1/4 NPT	543560	MSB4N-1/4:C3J3D1A1F3-WP	Q	543548	MSB4N-1/4:C3J1D1A1F3-WP	Q		
Fully automatic	1/4 NPT	543566	MSB4N-1/4:C3J4D1A1F3-WP	Q	543554	MSB4N-1/4:C3J2D1A1F3-WP	Q		

LT = Lead time      1D typically ships same day/next day      1W typically ships within 1 week      Q request a quote for lead time



# Pre-configured Combination Unit 8 – Inch Series

Technical Data

ISO Symbol

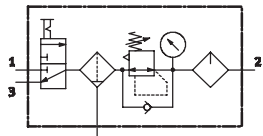

With manual bowl drain

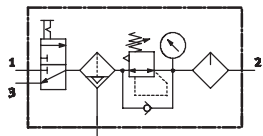

With fully automatic bowl drain

- For filtered and lubricated compressed air
- Supply pressure can be opened and closed
- Output pressure is infinitely adjustable within the pressure regulation range



This combination consists of:

- On-off valve MS...-EM1 manually actuated
- Filter regulator MS...-LFR-D7
- Lubricator MS...-LOE-R
- Mounting bracket MS...-WP

General Technical Data	
Pneumatic connection 1, 2, 3	1/4 NPT
Regulating function	With primary pressure compensation
	With return flow function
	With secondary venting
	Output pressure constant
Type of mounting	Via accessories
Assembly position	Vertical ±5°
Filtration grade [µm]	5 (air purity class at the output 3.7.- to DIN ISO 8573-1)
	40 (air purity class at the output 5.7.- to DIN ISO 8573-1)
Bowl guard	Plastic bowl guard
Bowl drain	Manual
	Fully automatic
Pressure adjustment	Rotary knob with detent
	Lockable with accessories
Pressure regulation range [psi]	15 ... 176
Pressure indicator	With pressure gauge

Standard Nominal Flow Rate q <sub>N</sub> [scfm]		
Filtration grade	5 µm	24.7
	40 µm	26.5

# Pre-configured Combination Unit 8 – Inch Series

Technical Data



Operating and Environmental Conditions		
Bowl drain	Manual	Fully automatic
Supply pressure [psi]	22 ... 206	22 ... 176
Operating medium	Filtered compressed air, lubricated or unlubricated, filtration grade 40 µm	
Ambient temperature [°F]	14 ... 140	41 ... 140
Temperature of medium [°F]	14 ... 140	41 ... 140
Storage temperature [°F]	14 ... 140	14 ... 140
Corrosion resistance CRC <sup>1)</sup>	2	

1) Corrosion resistance class 2 according to Festo standard 940 070  
 Components requiring moderate corrosion resistance. Externally visible parts with primarily decorative surface requirements which are in direct contact with a normal industrial environment or media such as coolants or lubricating agents.

Weights [lb]	
Service unit combination	3.00
Mounting bracket	0.08

• For spare parts go to: [www.festo.com/en/spare\\_parts\\_service](http://www.festo.com/en/spare_parts_service)

## Standard Flow Rate qn as a Function of Output Pressure p2

Pressure regulation range 15 ... 176 psi    Filtration grade 5 µm    Filtration grade 40 µm  
 MSB4N-¼

Primary pressure p1 = 147 psi

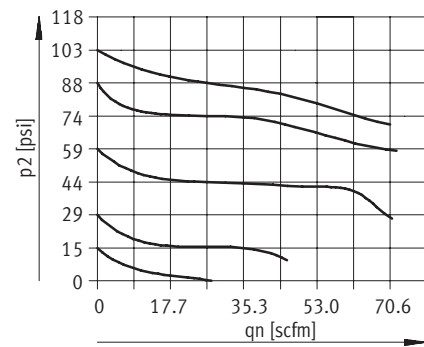
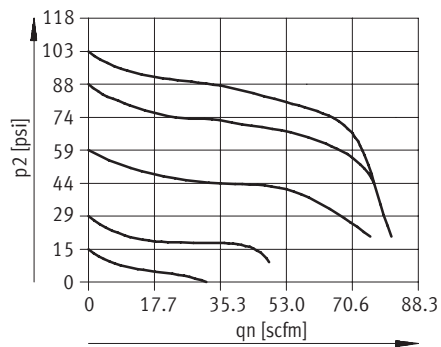

# Pre-configured Combination Unit 8 – Inch Series

Dimensional Drawings, Ordering Data – Pre-configured Products

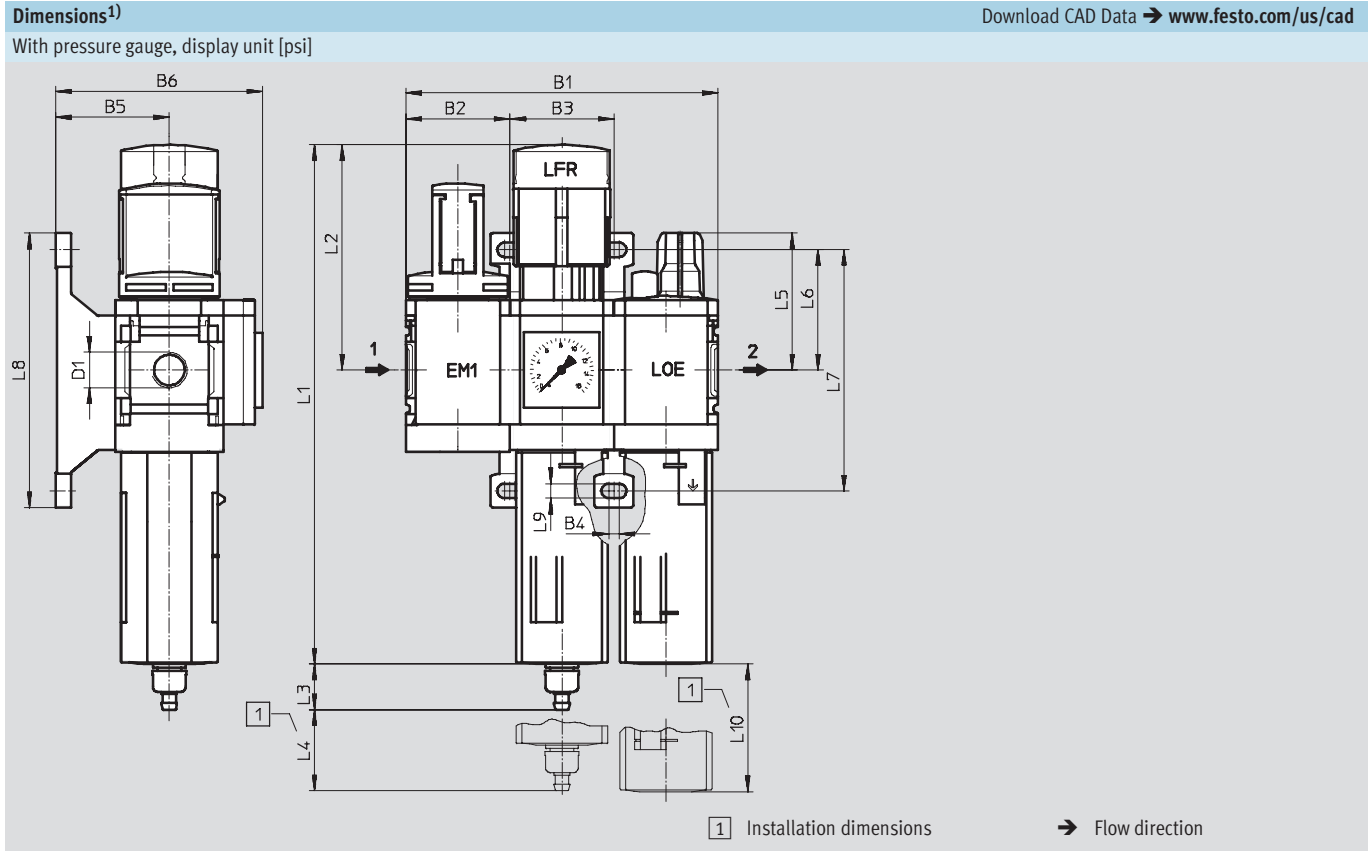

B1	B2	B3	B4	B5	B6	D1	L1	L2
4.75	1.58	1.58	0.16	1.73	3.15	¼ NPT	7.91	3.43

L3 Bowl drain		L4	L5	L6	L7	L8	L9	L10
manual	fully automatic							
0.70	0.80	0.98	2.09	1.83	3.67	4.17	0.22	3.15

1) Dimensions are in inches, unless otherwise noted.

Ordering Data									
Pressure regulation range 15 ... 176 psi									
Bowl drain	Connection	Filtration grade 5 µm				Filtration grade 40 µm			
		Part No.	Type	LT	Part No.	Type	LT		
Plastic bowl guard									
Manual	¼ NPT	543564	MSB4N-¼:C3J3M1-WP	Q	543552	MSB4N-¼:C3J1M1-WP	Q		
Fully automatic	¼ NPT	543570	MSB4N-¼:C3J4M1-WP	Q	543558	MSB4N-¼:C3J2M1-WP	Q		

LT = Lead time      1D typically ships same day/next day      1W typically ships within 1 week      Q request a quote for lead time

# Pre-configured Combination Unit 9 – Inch Series

Technical Data

ISO Symbol

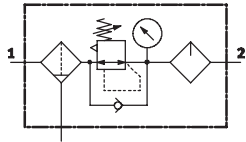

With manual bowl drain

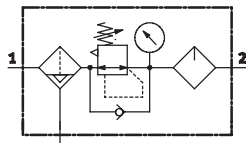

With fully automatic bowl drain

- For filtered and lubricated compressed air
- Output pressure is infinitely adjustable within the pressure regulation range



This combination consists of:

- Filter MS...-LF
- Pressure regulator MS...-LR
- Lubricator MS...-LOE
- Mounting bracket MS...-WP

General Technical Data	
Pneumatic connection 1, 2	1/4 NPT
Type of mounting	Via accessories
Assembly position	Vertical ±5°
Filtration grade [µm]	5 (air purity class at the output 3.7.– to DIN ISO 8573-1) 40 (air purity class at the output 5.7.– to DIN ISO 8573-1)
Bowl guard	Plastic bowl guard
Bowl drain	Manual Fully automatic
Pressure adjustment	Rotary knob with detent Lockable with accessories
Pressure regulation range N3 [psi]	15 ... 176
Pressure indicator	With pressure gauge

Standard Nominal Flow Rate qnN [scfm]		
Filtration grade	5 µm	24.7
	40 µm	28.2

# Pre-configured Combination Unit 9 – Inch Series

Technical Data



Operating and Environmental Conditions		
Bowl drain	Manual	Fully automatic
Supply pressure [psi]	22 ... 206	22 ... 176
Operating medium	Filtered compressed air, lubricated or unlubricated, filtration grade 40 µm	
Ambient temperature [°F]	14 ... 140	41 ... 140
Temperature of medium [°F]	14 ... 140	41 ... 140
Storage temperature [°F]	14 ... 140	14 ... 140
Corrosion resistance CRC <sup>1)</sup>	2	

1) Corrosion resistance class 2 according to Festo standard 940 070  
 Components requiring moderate corrosion resistance. Externally visible parts with primarily decorative surface requirements which are in direct contact with a normal industrial environment or media such as coolants or lubricating agents.

Weights [lb]	
With plastic bowl guard	2.00
Mounting bracket	0.08

- For spare parts go to: [www.festo.com/en/spare\\_parts\\_service](http://www.festo.com/en/spare_parts_service)

## Standard Flow Rate qn as a Function of Output Pressure p2

Pressure regulation range N3      Filtration grade 5 µm      Filtration grade 40 µm  
 MSB4N-¼

Primary pressure p1 = 147 psi

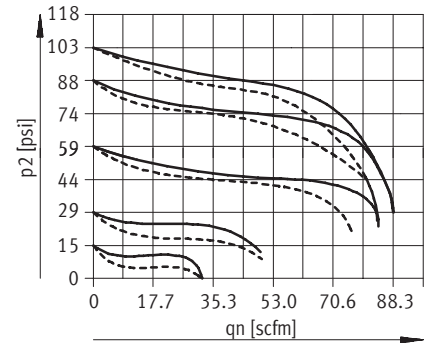
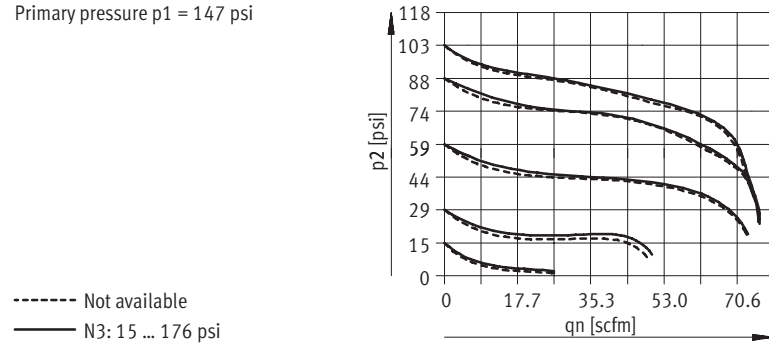

# Pre-configured Combination Unit 9 – Inch Series

Dimensional Drawings, Ordering Data – Pre-configured Products

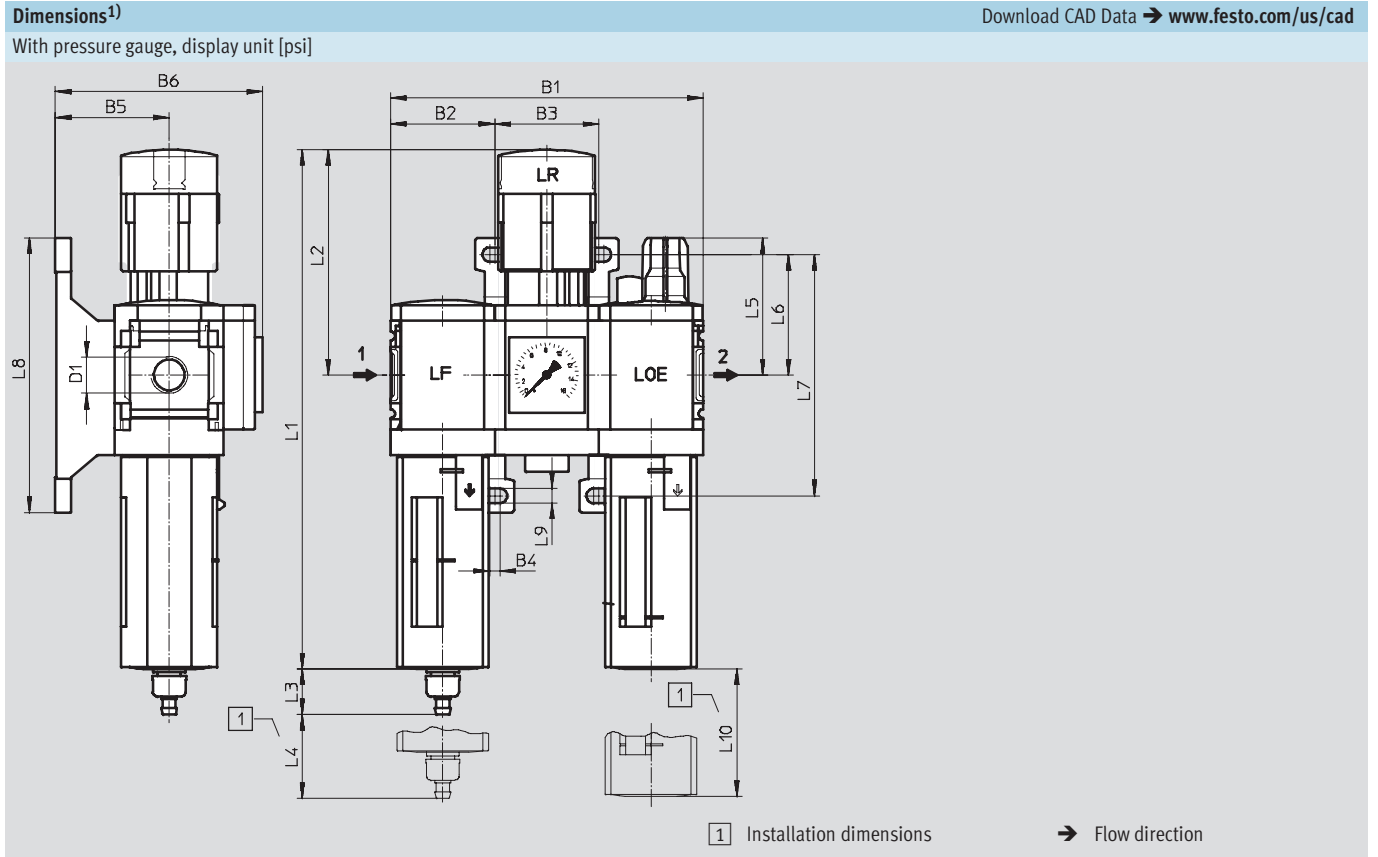

B1	B2	B3	B4	B5	B6	D1	L1	L2
4.75	1.58	1.58	0.16	1.73	3.15	¼ NPT	7.91	3.43

L3 Bowl drain		L4	L5	L6	L7	L8	L9	L10
manual	fully automatic							
0.70	0.80	0.98	2.09	1.83	3.67	4.17	0.22	3.15

1) Dimensions are in inches, unless otherwise noted.

Ordering Data									
Pressure regulation range 15 ... 176 psi									
Bowl drain		Connection		Filtration grade 5 µm			Filtration grade 40 µm		
				Part No.	Type	LT	Part No.	Type	LT
Plastic bowl guard									
Manual	¼ NPT	541433	MSB4N-¼:H3N3M1-WP			1W	541432	MSB4N-¼:H2N3M1-WP	1W
Fully automatic	¼ NPT	541434	MSB4N-¼:H4N3M1-WP			1W	541431	MSB4N-¼:H1N3M1-WP	1W

LT = Lead time      1D typically ships same day/next day      1W typically ships within 1 week      Q request a quote for lead time

# Pre-configured Combination Units MSB4N – Inch Series

Accessories Overview

## Mounting Attachments and Accessories

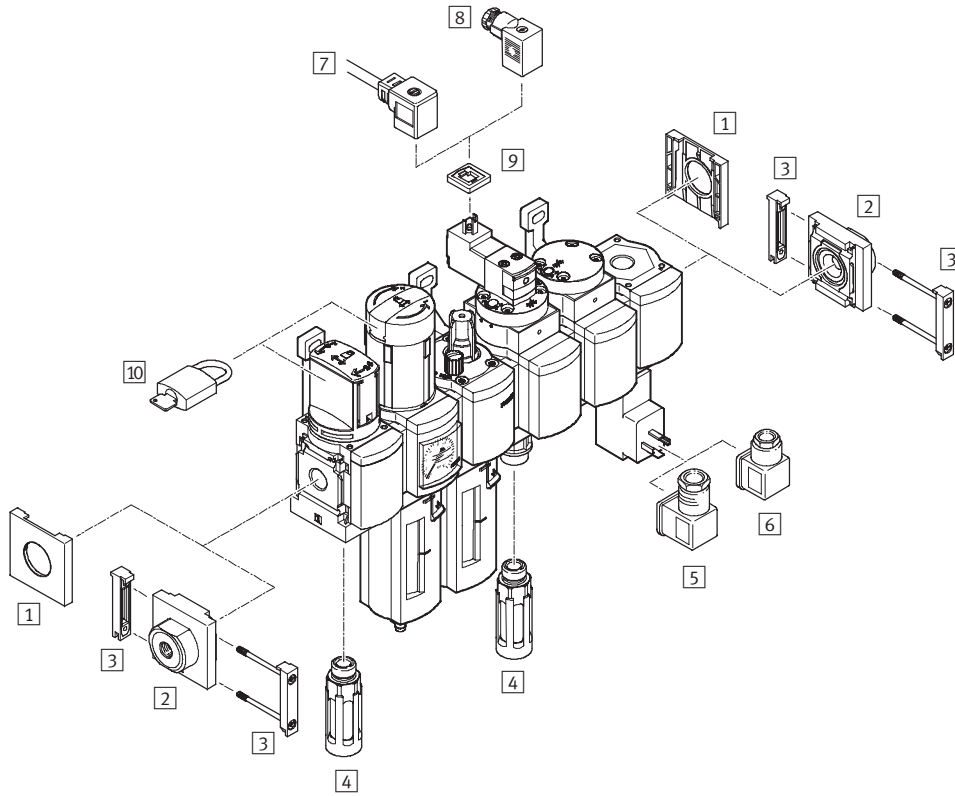

**Note**

The choice of accessories depends on the selected combination unit.

Range of accessories

→ See the accessories pages of the individual devices

Single unit and combination unit mounting brackets.

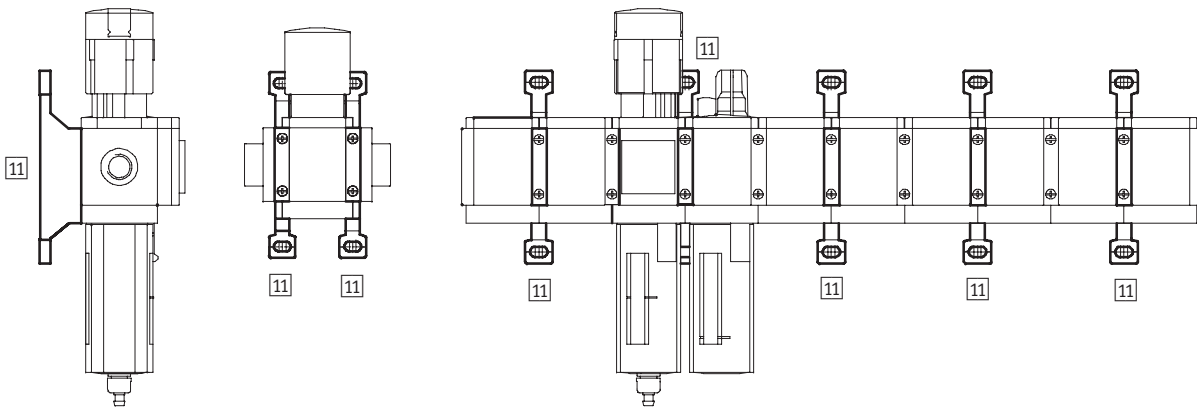

## Pre-configured Combination Units MSB4N – Inch Series

Accessories Overview

**FESTO**

Mounting Attachments and Accessories		→ Page
1	Cover cap MS4-END	89
2	Port plate MS4N-AQ...	90
3	Body connector MS4-MV	90
4	Silencer U	95
5	Angled socket PEV-1/4-WD-LED	95
6	Plug socket MSSD-C-4P	95
7	Plug socket with cable KMEB	95
8	Plug socket MSSD-EB	95
9	Illuminating seal MEB-LD	95
10	Padlock LRVS-D	95
11	Mounting bracket (for service unit MSB-FRC) MS4-WP/WPB/WPM	91



# Pre-configured Combination Units MSB4N – Inch Series

Accessories

## 1 Cover cap MS4-END

- Can be used to cover the body sides of the first and last module if port plates are not used.

Material:  
Reinforced polyamide  
Free of copper and PTFE

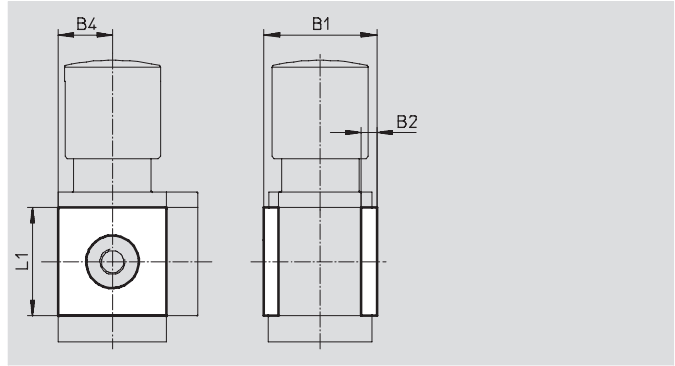
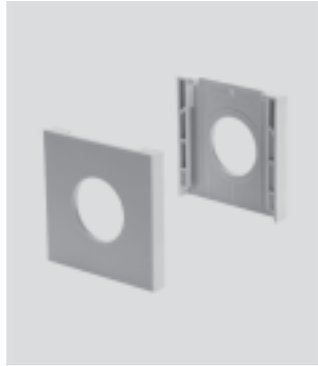

Dimensions and Ordering Data						
B1	B2	B4	L1	Part No.	Type	
1.72	0.24	0.83	1.65	538779	MS4-END	

## Mounting plate MS4-AEND

- In combination with mounting bracket MS-WP or MS-WPB for mounting an individual unit with body thread on a wall

Material:  
Reinforced polyamide  
Conforms to RoHS  
Free of copper and PTFE

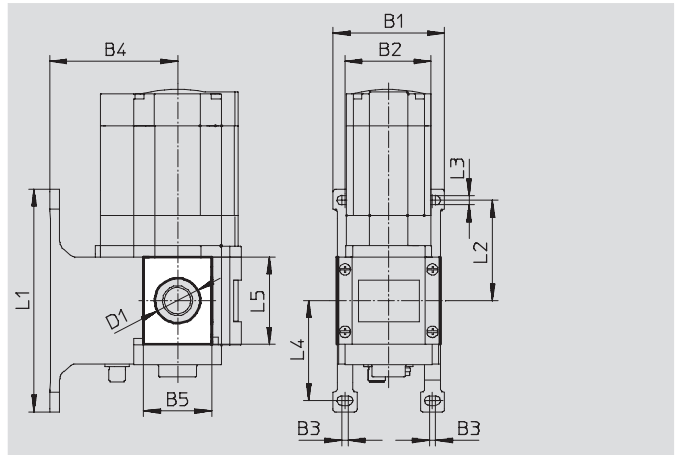

Dimensions and Ordering Data															
B1	B2	B3	B4		B5	D1 ∅	L1	L2	L3	L4	L5	CRC <sup>1)</sup>	Weight [lb]	Part No.	Type
			WP	WPB											
2.17	1.58	0.16	1.73	2.60	1.20	0.80	4.17	1.83	0.22	1.84	1.65	2	0.01	542 966	MS4-AEND

1) Corrosion resistance class 2 according to Festo standard 940 070  
Components requiring moderate corrosion resistance. Externally visible parts with primarily decorative surface requirements which are in direct contact with a normal industrial environment or media such as coolants or lubricating agents.

# Pre-configured Combination Units MSB4N – Inch Series

Accessories

## 2 Port plate MS4N-AQ...

- Adapter for pneumatic connection

Material:  
Aluminum

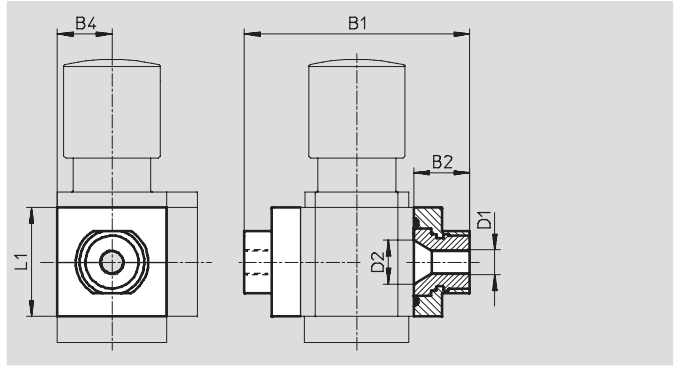

Dimensions and Ordering Data								
B1	B2	B4	D1	D2	L1	Weight [lb]	Part No.	Type
3.29	0.85	0.83	1/8 NPT	0.66	1.65	0.26	526065	MS4N-AQK
			1/4 NPT				526066	MS4N-AQN
			3/8 NPT				526067	MS4N-AQP

## 3 Body connector MS4-MV

- For connecting modules

Material:  
Stainless steel/polyacetate



Ordering Data		
Weight [lb]	Part No.	Type
0.07	532798	MS4-MV

# Pre-configured Combination Units MSB4N – Inch Series

Accessories

## 11 Mounting Bracket MS4-WP...

Suggested placement of wall mounting brackets when mounting air preparation combinations

1 unit: 1.575 in

2 units: 3.15 in

- 1 Mounting bracket WP, WPB or WPM-D
- 2 Mounting bracket WP, WPB or WPM-2D

Number of units

1 2 3 4 5 6 7 8 9 10

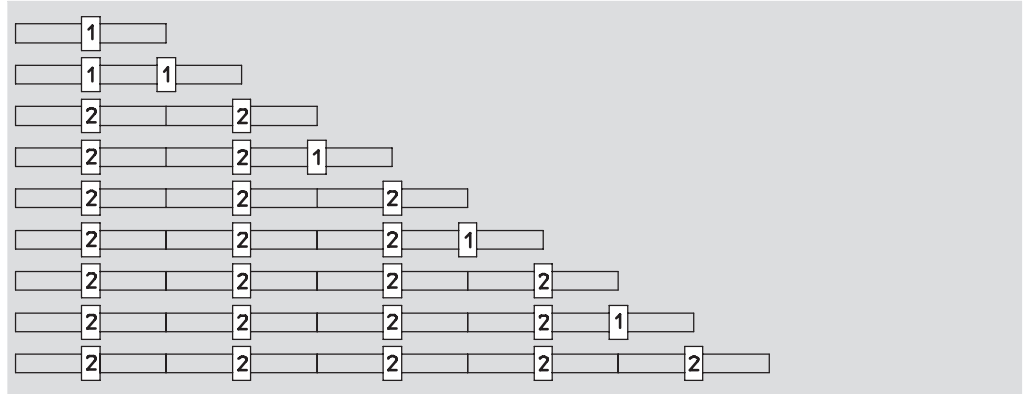

## Mounting dimensions

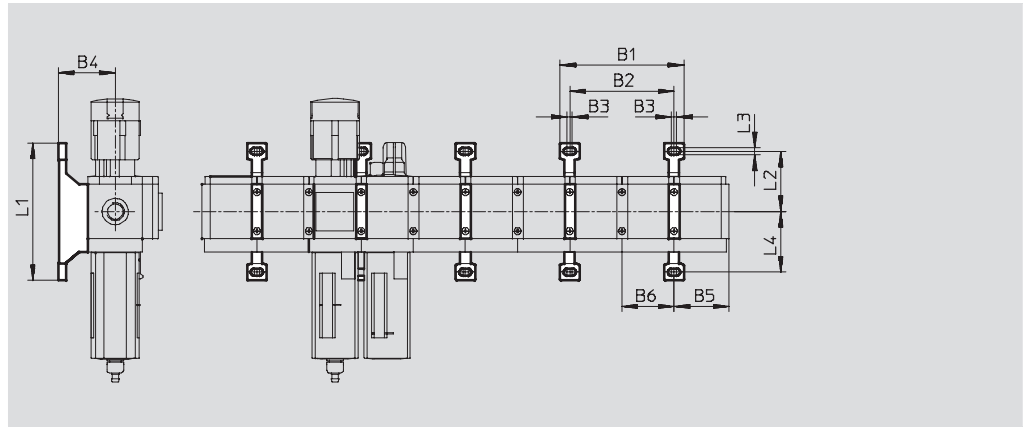

Type	B1	B2	B3	B4	B5	B6	L1	L2	L3	L4
MS4-WP	3.75	3.15	0.16	1.73	1.65	1.57	4.17	1.83	0.22	1.84
MS4-WPB				2.60						
MS4-WPM-...D				1.73						

# Pre-configured Combination Units MSB4N – Inch Series



Accessories

## Mounting bracket MS4-WP

- To connect the modules for wall mounting
- In combination with a port plate MS-AG... for mounting an individual unit on a wall
- In combination with mounting plate MS-AEND or for mounting an individual unit with body thread on a wall
- For pressure regulator LRB with angled outlet block B... at rear

Material:  
Die-cast aluminum

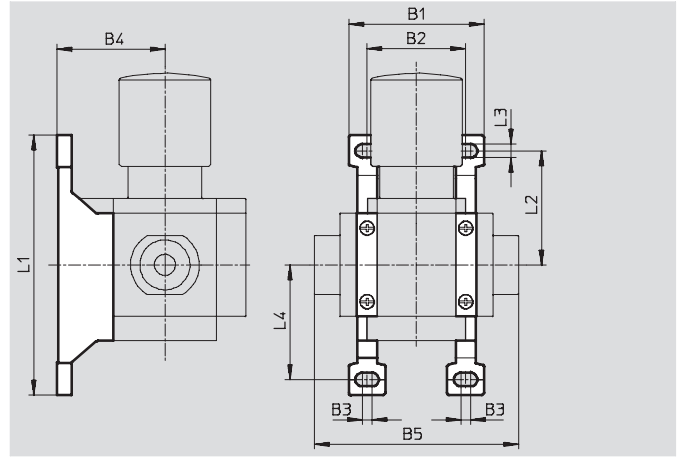

Dimensions and Ordering Data											
B1	B2	B3	B4	B5	L1	L2	L3	L4	Weight [lb]	Part No.	Type
2.17	1.58	0.16	1.73	3.28	4.17	1.83	0.22	1.84	0.08	532184	MS4-WP

## Mounting bracket MS4-WPB

- To connect the modules for wall mounting
- In combination with a port plate MS-AG... for mounting an individual unit on a wall
- In combination with mounting plate MS-AEND or for mounting an individual unit with direct thread on a wall
- Provides large wall gap for pressure regulator

Material:  
Die-cast aluminum

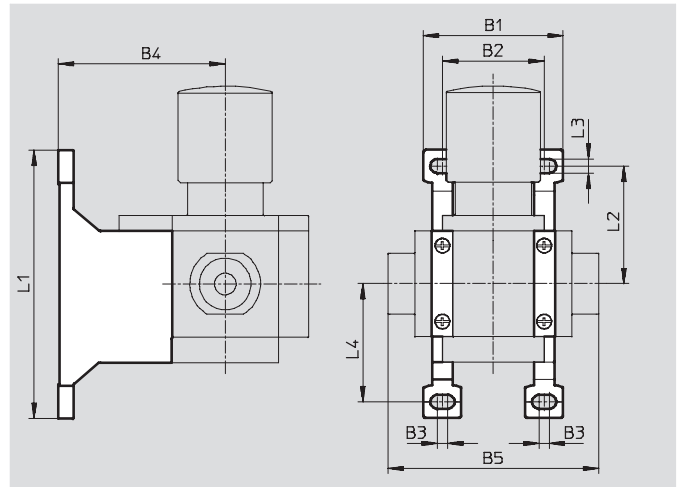

Dimensions and Ordering Data											
B1	B2	B3	B4	B5	L1	L2	L3	L4	Weight [lb]	Part No.	Type
2.17	1.58	0.16	2.60	3.28	4.17	1.83	0.22	1.84	0.11	526063	MS4-WPB

# Pre-configured Combination Units MSB4N – Inch Series

Accessories

## Mounting bracket MS4-WPM

- To connect the modules for wall mounting
- In combination with a port plate MS-AG... for mounting an individual unit on a wall
- Speedy attachment and detachment
- For installation of modules with regulating knob pointing downwards

The distance piece D or 2D (designated in the type code) is included in the scope of delivery and ensures the correct clearance

Material:  
Die-cast aluminum

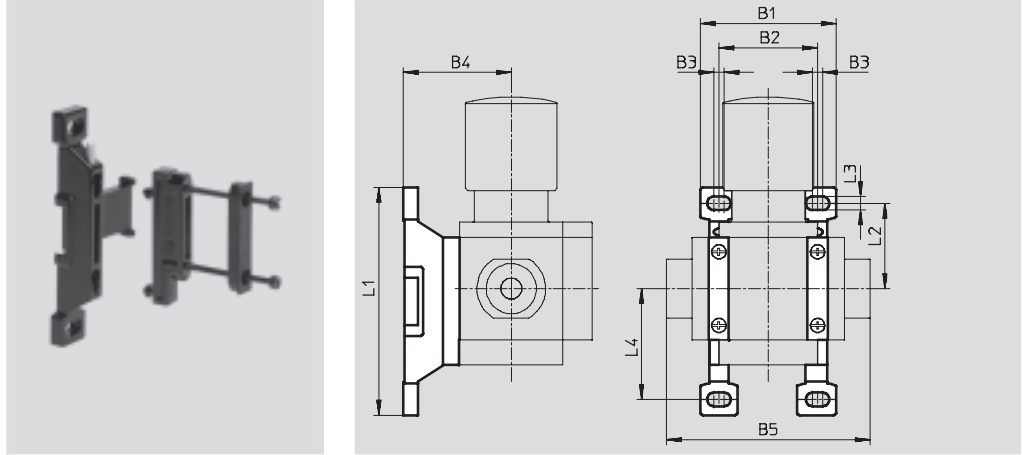

Dimensions and Ordering Data												
B1	B2	B3	B4	B5	L1	L2	L3	L4	Clearance	Weight [lb]	Part No.	Type
2.17	1.57	0.16	1.73	3.28	3.65	1.37	0.22	1.78	1.57	0.09	526060	MS4-WPM-D
3.75	3.15			4.86					3.15	0.11	526061	MS4-WPM-2D

## Body connector MS4-MVM

- For installation of modules with regulating knob pointing downwards

Material:  
Die-cast aluminum



Ordering Data		
Size	Part No.	Type
MS4	532800	MS4-MVM

## Pre-configured Combination Units MSB4N – Inch Series

FESTO

Accessories

Filter cartridge MS4-LF...



MS...-LFM



MS...-LFP



MS...-LFX

Ordering Data			
	Filtration grade [μm]	Part No.	Type
Micro-filter cartridge	0.01	162674	MS4/D-MINI-LFM-A
Fine-filter cartridge	1	162677	MS4/D-MINI-LFM-B
Filter cartridge	5	534501	MS4-LFP-C
Filter cartridge	40	534502	MS4-LFP-E
Active carbon filter cartridge	Residual oil content ≤ 0.003 mg/m <sup>3</sup>	532912	MS4/D-MINI-LFX

# Pre-configured Combination Units MSB4N – Inch Series

Accessories



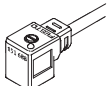

5 Ordering Data – Angled Socket PEV					Technical data → <a href="http://www.festo.com/catalog/pev">www.festo.com/catalog/pev</a>	
	Description	Operating voltage range	Electrical connection	Switching status display	Part No.	Type
	for PEV-1/4-...-OD	15 ... 30 V DC	4-pin	Yellow LED	164274	PEV-1/4-WD-LED-24
		≤ 230 V AC ≤ 180 V DC	4-pin	Yellow LED	164275	PEV-1/4-WD-LED-230

6 Ordering Data – Plug Socket MSSD					Technical data → <a href="http://www.festo.com/catalog/mssd">www.festo.com/catalog/mssd</a>	
	Description	Operating voltage range	Electrical connection	Type of mounting cable connection	Part No.	Type
	for PEV-1/4-...-OD	≤ 250 V AC/DC	3-pin	Clamping screws	171157	MSSD-C-4P
	for MS4N-EE/DE	≤ 250 V AC/DC	3-pin	Clamping screws	151687	MSSD-EB
			4-pin	Insulation displacement technology	192745	MSSD-EB-S-M14

7 Ordering Data – Plug Socket with Cable KMEB					Technical data → <a href="http://www.festo.com/catalog/kmeb">www.festo.com/catalog/kmeb</a>	
	Description	Operating voltage range	Switching status display	Cable length [ft]	Part No.	Type
	for MS4N-EE/DE	24 V DC	LED	8.2	151688	KMEB-1-24-2,5-LED
		24 V DC	LED	16.4	151689	KMEB-1-24-5-LED
		24 V DC	LED	32.8	193457	KMEB-1-24-10-LED
		230 V AC	–	8.2	151690	KMEB-1-230AC-2,5
		230 V AC	–	16.4	151691	KMEB-1-230AC-5

9 Ordering Data – Illuminating Seal MEB-LD				Technical data → <a href="http://www.festo.com/catalog/meb-ld">www.festo.com/catalog/meb-ld</a>	
	Description	Operating voltage range		Part No.	Type
	for plug socket with cable KMEB and plug socket MSSD-EB	12 ... 24 V DC		151717	MEB-LD-12-24DC
		230 V DC/AC ±10%		151718	MEB-LD-230AC

4 Ordering Data – Silencer U				Technical data → <a href="http://www.festo.com/catalog/u">www.festo.com/catalog/u</a>	
	Description	Pneumatic connection		Part No.	Type
	for MS4N-EM1/EE	1/4 NPT		12639	U-1/4-B-NPT

10 Ordering Data – Padlock LRVS-D					
	Description	Weight [lb]		Part No.	Type
	for regulators, filter/regulators and manual on-off valves	0.24		193786	LRVS-D

Ordering Data – Special Oil OFSW					
	Description	Scope of delivery		Part No.	Type
	for lubricators	1 liter		152811	OFSW-32





# Festo - Your Partner in Automation



**1 Festo Inc.**  
5300 Explorer Drive  
Mississauga, ON L4W 5G4  
Canada

**Festo Customer Interaction Center**  
Tel: 1 877 463 3786  
Fax: 1 877 393 3786  
Email: customer.service.ca@festo.com



**2 Festo Pneumatic**  
Av. Ceylán 3,  
Col. Tequesquináhuac  
54020 Tlalnepantla,  
Estado de México

**Multinational Contact Center**  
01 800 337 8669  
ventas.mexico@festo.com



**3 Festo Corporation**  
1377 Motor Parkway  
Suite 310  
Islandia, NY 11749

**Festo Customer Interaction Center**  
1 800 993 3786  
1 800 963 3786  
customer.service.us@festo.com



**4 Regional Service Center**  
7777 Columbia Road  
Mason, OH 45040

Connect with us



[www.festo.com/socialmedia](http://www.festo.com/socialmedia)



[www.festo.com](http://www.festo.com)

Subject to change