

Solenoid valves MH1, miniature

FESTO

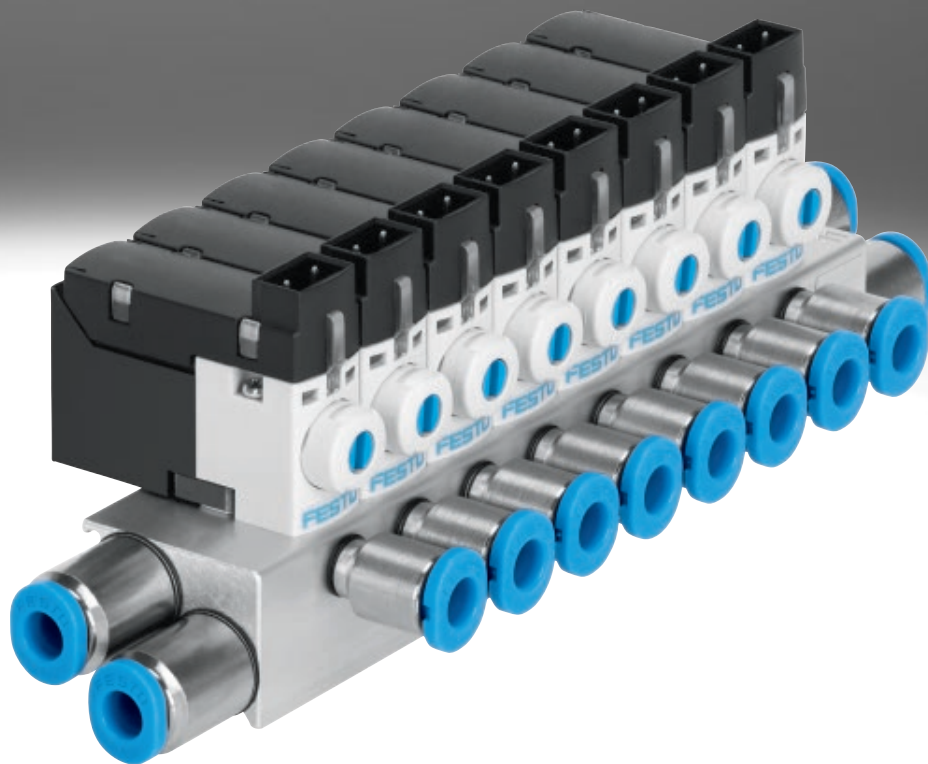

Key features

Complete product range for a variety of applications

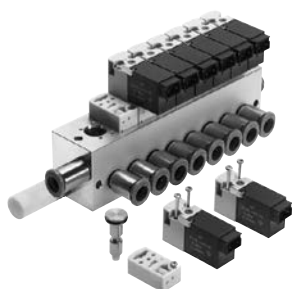

Extremely small

The new miniaturised generation of poppet valves offers flow rates of 14 l/min in the 2/2-way version or 10 l/min in the 3/2-way version. Available either as an individual sub-base valve or pre-assembled on a PR manifold rail. In addition, it is compact to mount using a PR manifold rail. For increased requirements and speed, the bigger MH2 with a flow rate of up to 100 l/min is the ideal solution.

Extremely versatile and fast

The miniature valves can be linked together via a pneumatic multiple connector plate or electrical multi-pin connection. There is also a choice between having electrical connections horizontally, on top and underneath. Another interesting variant: mounting on a circuit board including connection. All components are tested and assembled for Festo plug and work. And if a system needs to run as fast as possible, that's no problem! The response time of the miniature valves is 4 ms.

Totally coordinated

Festo offers an extensive product range including drives, rodless drives, mini slides, rotary drives and accessories under the umbrella term "compact". Perfectly coordinated and geared towards all production areas for manufacturing and processing very small products. All the components comply with the proven quality standards from Festo and include the added value that only a global company can offer.

Miniature valves not just for the electronics industry

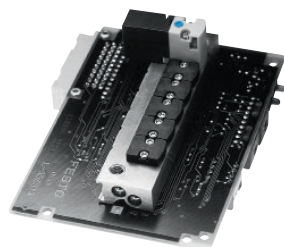

They can also be used in the light assembly, medical technology and semiconductor industries and wherever extremely compact and fast-switching valves or pilot valves are required for valves coming into contact with media (e.g. process industry).

With response times of approx. 4 ms, these valves satisfy all requirements for speed. Vacuum functions can also be easily implemented. The 100% duty cycle and the three-shift operation guarantee maximum cost-effectiveness.

With flow rates of 10 and 14 l/min for the miniature valves, there is always sufficient volume for the pilot control of process valves. The flow rate is also adequate for the wide range of compact cylinders, rotary drives and slides from Festo. For increased requirements of up to 100 l/min: MH2.

Ordering data – Product options

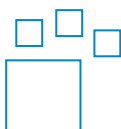

Configurable product
This product and all its product options can be ordered using the configurator.

The configurator can be found at
→ www.festo.com/catalogue/...
Enter the part number or the type.

Part no. Type MH1
197334

Key features – Pneumatic components

Operation with different pressures

Vacuum operation

The flow direction of the MH1 valves is clearly defined and cannot be reversed.

This must be observed even when operating the valve with vacuum.

This is achieved by connecting the vacuum to port 3 or 2 (33 or 11).

Reverse operation

Reverse operation is not possible; the direction of flow cannot be reversed.

**Note**

Vacuum must not be connected to port 1.

2/2-way valve

- Vacuum operation is realised by connecting vacuum at port 2
- An ejector pulse can only be realised with another valve

3/2-way valve

- Vacuum operation is realised by connecting vacuum at port 3
- Exhausting (or pressurisation) takes place via port 1
- Normally open with vacuum operation

3/2-way valve

- Vacuum operation is realised by connecting vacuum at port 33
- Exhausting (or pressurisation) takes place via port 11
- Normally closed with vacuum operation

2x2/2-way valve

- Vacuum operation is realised by connecting vacuum at port 11
- The ejector pulse is connected at port 1

Example

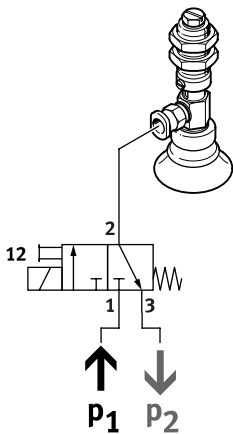

With the 3/2-way valve, normally closed, vacuum operation is realised by connecting the vacuum (P2) to port 3 and connecting e.g. a silencer for exhausting (P1) to port 1. This changes the normal position from "closed" to "open".

Product range overview

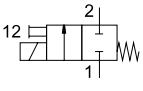
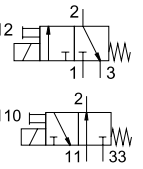
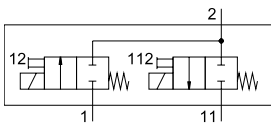
Function	Circuit symbol	Version	Operating voltage			→ Page/Internet
			5 V DC	12 V DC	24 V DC	
2/2-way valve		Standard nominal flow rate 14 l/min				
		Semi-in-line valve	■	■	■	13
		Sub-base valve without LED	■	■	■	23
		Standard nominal flow rate 30 l/min, controls vacuum or ejector pulse				
		Sub-base valve with LED	–	–	■	56
3/2-way valve ¹⁾		Standard nominal flow rate 10 l/min				
		Semi-in-line valve	■	■	■	13
		Sub-base valve without LED	■	■	■	23
		Sub-base valve with E-box	■	■	■	35
		Sub-base valve with LED	–	–	■	43
2x2/2-way valve		Standard nominal flow rate 30 l/min, controls vacuum and ejector pulse				
		Sub-base valve with LED	–	–	■	56

1) Can be used as a 2/2-way valve by sealing port 1 or 3

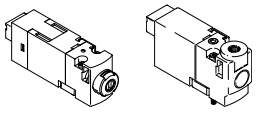
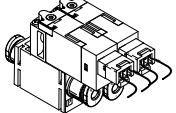
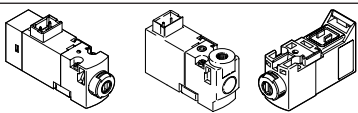
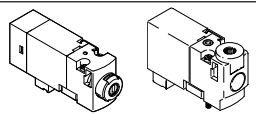
Mounting options					
Design		Semi-in-line valve	Sub-base valve		
Electrical connection		Without LED	Without LED	With E-box	With LED
Plug connection at the rear (HC)					
	Individual sub-base	■	■	–	■
	Manifold assembly	■	■	–	■
	Sub-base with 2x2/2-way valve fully assembled	–	–	–	■
Plug connection on top (TC)					
	Individual sub-base	■	■	■	■
	Manifold assembly	■	■	■	■
Plug connection underneath (PI)					
	Individual sub-base with plug base	■	■	–	■
	Manifold assembly with plug bases	■	■	–	■
	Manifold assembly with plug bases and electrical multi-pin plug	■	■	–	■
	Manifold assembly on circuit board with soldering bases	■	■	–	■
	Manifold assembly on a circuit board with soldering bases and pneumatic multiple connector plate	–	■	–	■

Peripherals overview

Semi in-line valve with plug connection at the rear, plug connection on top

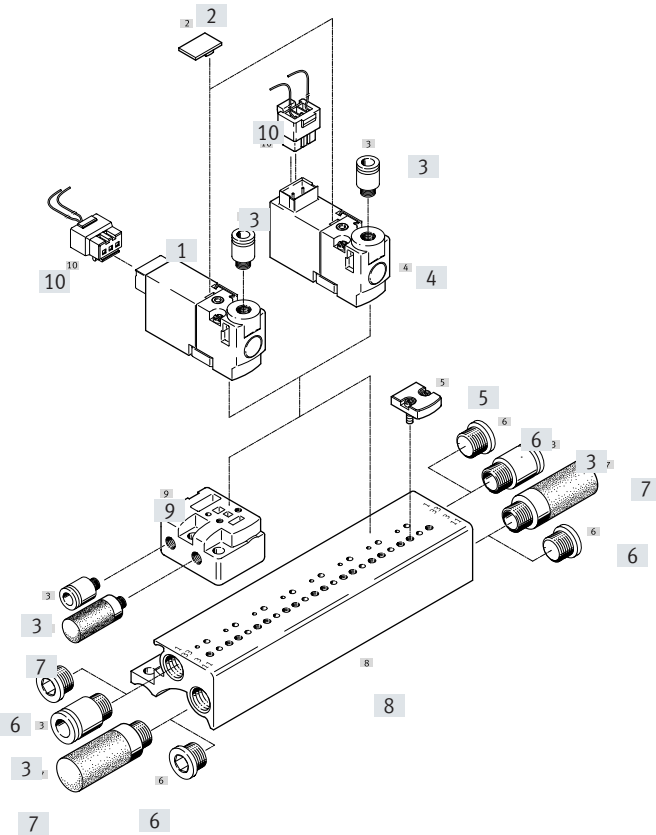

Designation	Description	→ Page/Internet
[1] Solenoid valve	Valve with plug connection at the rear	19
[2] Inscription label	For identifying the valve positions	21
[3] Push-in fitting	For connecting compressed air tubing with standard O.D.	21
[4] Solenoid valve	Valve with plug connection on top	19
[5] Cover plate	For manifold rail without plug bases	20
[6] Blanking plug	For sealing ports that are not required	21
[7] Silencer	For exhaust ports	21
[8] Manifold rail	Without plug bases	20
[9] Individual sub-base	For valves with plug connection at the rear, plug connection on top	20
[10] Plug socket with cable	Straight socket, plug pattern H, 3-pin	22

Peripherals overview

Semi in-line valve with plug connection underneath

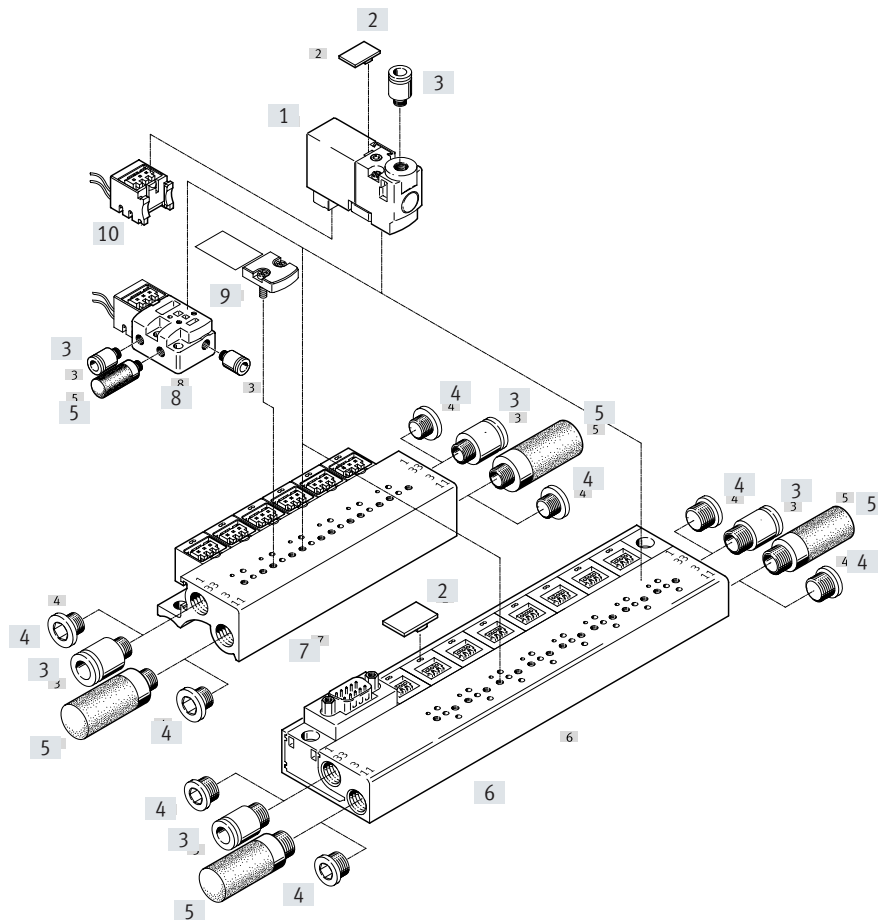

Designation	Description	→ Page/Internet
[1] Solenoid valve	Valve with plug connection underneath	19
[2] Inscription label	For identifying the valve positions	21
[3] Push-in fitting	For connecting compressed air tubing with standard O.D.	21
[4] Blanking plug	For sealing ports that are not required	21
[5] Silencer	For exhaust ports	21
[6] Manifold rail	With plug bases and electrical multi-pin plug, Sub-D	20
[7] Manifold rail	With plug bases	20
[8] Individual sub-base	For valves with plug connection underneath	20
[9] Cover plate	For manifold rail with plug bases	20
[10] Electrical plug-in base	Straight socket, plug pattern H, 3-pin	22

Peripherals overview

Semi in-line valve with plug connection underneath, mounting on a circuit board

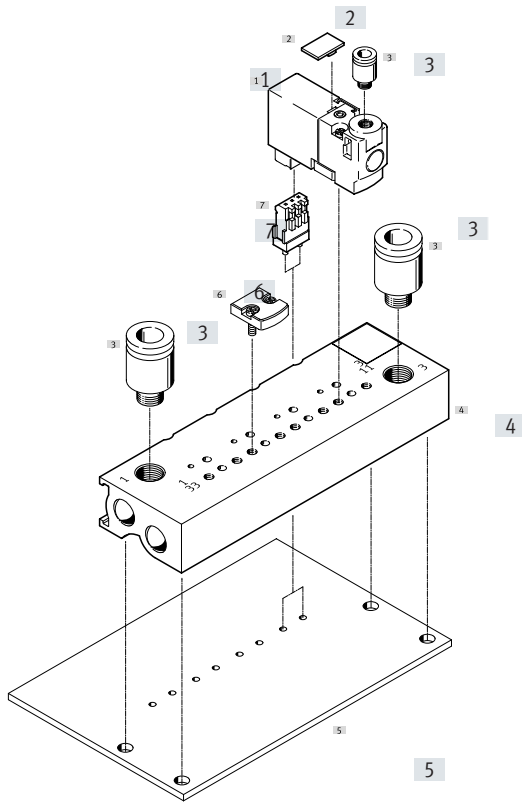

Designation	Brief description	→ Page/Internet
[1] Solenoid valve	Valve with plug connection underneath	19
[2] Inscription label	For identifying the valve positions	21
[3] Push-in fitting	For connecting compressed air tubing with standard O.D.	21
[4] Manifold rail	Without plug bases, for mounting on a circuit board	20
[5] Circuit board	Not included in the scope of delivery	–
[6] Cover plate	For manifold rail without plug bases	20
[7] Soldering base	For mounting on a circuit board, 3-pin	22

Peripherals overview

Sub-base valve with plug connection at the rear, plug connection on top

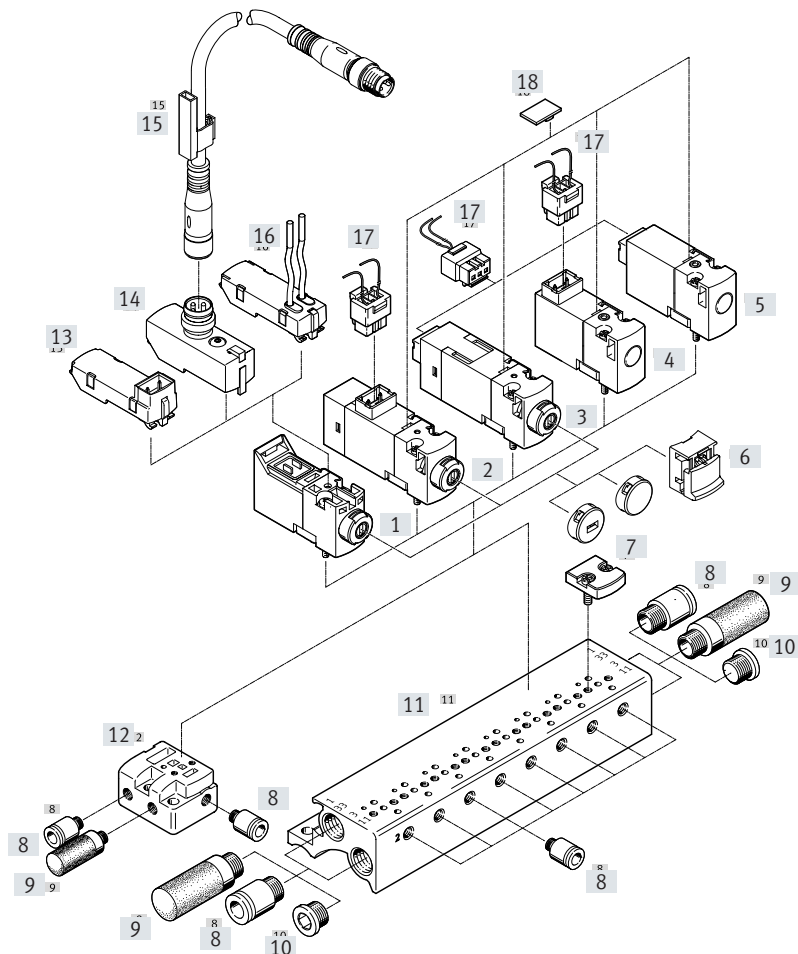

Designation	Description	→ Page/Internet
[1] Solenoid valve	Valve without plug connection, with manual override	39
[2] Solenoid valve	Valve with plug connection on top, with LED, with manual override	51
[3] Solenoid valve	Valve with plug connection at the rear, with LED, with manual override	51
[4] Solenoid valve	Valve with plug connection on top, without LED, without manual override	31
[5] Solenoid valve	Valve with plug connection at the rear, without LED, without manual override	31
[6] Cover cap	For manual override	40, 53
[7] Cover plate	For manifold rail without plug bases	33, 40, 53
[8] Push-in fitting	For connecting compressed air tubing with standard O.D.	33, 40, 53
[9] Silencer	For exhaust ports	33, 40, 53
[10] Blanking plug	For sealing ports that are not required	33, 40, 53
[11] Manifold rail	Without plug bases	32, 39, 52
[12] Individual sub-base	For valves with plug connection at the rear, plug connection on top	32, 39, 52
[13] E-box	Plug pattern H/plug pattern S	41
[14] E-box	Plug M8x1	41
[15] Connecting cable	Socket M8x1, 4-pin	42
[16] E-box	Open end	41
[17] Plug socket with cable	Straight socket, plug pattern H, 3-pin	34, 42, 54
[18] Inscription label	For identifying the valve positions	34, 54

Peripherals overview

Sub-base valve with plug connection underneath

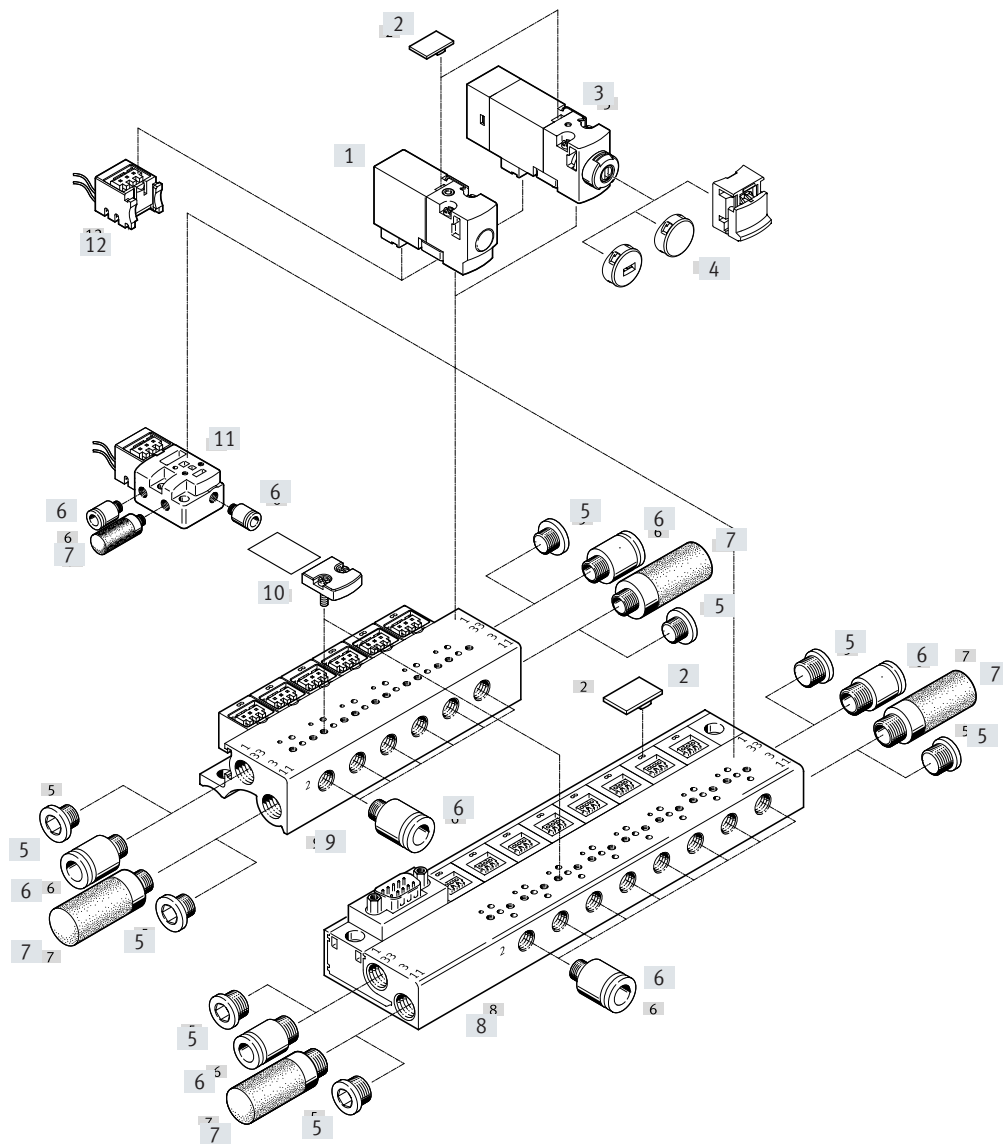

Designation	Description	→ Page/Internet
[1] Solenoid valve	Valve with plug connection underneath, without LED	31
[2] Inscription label	For identifying the valve positions	34, 54
[3] Solenoid valve	Valve with plug connection underneath, with LED	51
[4] Cover cap	For manual override	40, 53
[5] Blanking plug	For sealing ports that are not required	33, 53
[6] Push-in fitting	For connecting compressed air tubing with standard O.D.	33, 53
[7] Silencer	For exhaust ports	33, 53
[8] Manifold rail	With plug bases	32, 52
[9] Manifold rail	With plug bases and electrical multi-pin plug	32, 52
[10] Cover plate	For manifold rail with plug bases	33, 53
[11] Individual sub-base	For valves with plug connection underneath	32, 52
[12] Plug socket with cable	Straight socket, plug pattern H, 3-pin	34, 54

Peripherals overview

Sub-base valve with plug connection underneath, mounting on a circuit board

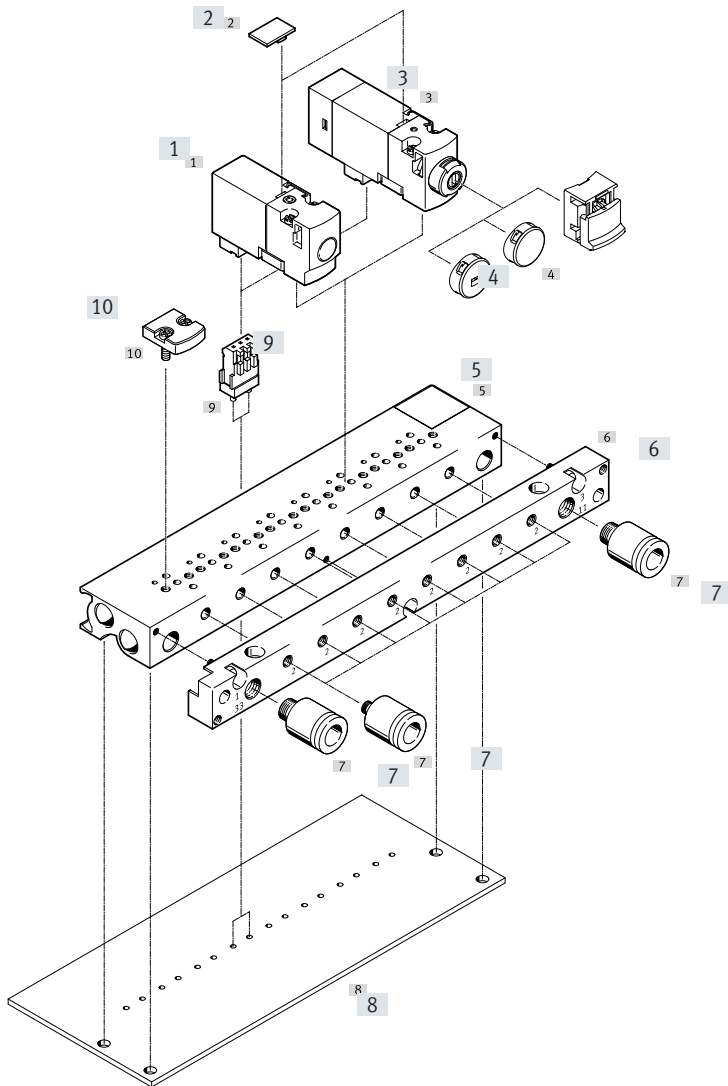

	Description	→ Page/Internet	
[1]	Solenoid valve	Plug connection underneath, without LED	31
[2]	Inscription label	For identifying the valve positions	34, 54
[3]	Sub-base valve	Plug connection underneath, with LED	51
[4]	Cover cap	For manual override	40, 53
[5]	Manifold rail	Without plug bases for mounting on a circuit board	32, 52
[6]	Pneumatic multiple connector plate	Enables the tubing connection to be left in place on the circuit board when changing the valve terminal (included in the scope of delivery)	–
[7]	Push-in fittings	For connecting compressed air tubing with standard O.D.	33, 53
[8]	Circuit board	Provided by the customer (not included in the scope of delivery)	–
[9]	Soldering base	For plug-in connection, 3-pin	34, 54
[10]	Cover plate	For manifold rail without plug bases	33, 53

Type codes

001	Series
MHP1	Solenoid valve MHP1
MHA1	Solenoid valve MHA1

002	Drive system
M	Solenoid, switching

003	Nominal operating voltage
1	24 V DC
4	5 V DC
5	12 V DC

004	Display
	None
L	LED

005	Manual override
H	Non-detenting
R	Non-detenting, detenting

006	Valve function
2/2	2/2-way valve
3/2	3/2-way valve
2X2/2	Double 2/2-way valve on sub-base

007	Normal position
G	Closed
O	Open

008	Nominal size
0,6	0.65 mm
0,9	0.9 mm
1,5	1.5 mm

009	Pneumatic connection
M3	Thread M3

010	Electrical connection
	With connection for 10 mm cartridge
HC	Rear plug connection for plug socket NEBV-H1G2
TC	Plug connection on top for plug socket NEBV-H1G2
PI	Plug connection underneath for plug-in connection
P3	Without plug connection
333	With push-in connector for tubing O.D. 3 mm
444	With push-in connector for tubing O.D. 4 mm
443	With push-in connector for tubing O.D. 4 mm, connection 2 with push-in connector for tubing O.D. 3 mm

 **Note**

Further variants and accessories can be configured and ordered online via the modular product system.

Datasheet

-  - Voltage
 5 V DC
 12 V DC
 24 V DC
 24 V AC

-  - Pressure
 -0.9 ... +8 bar

-  - Temperature range
 -5 ... +40°C

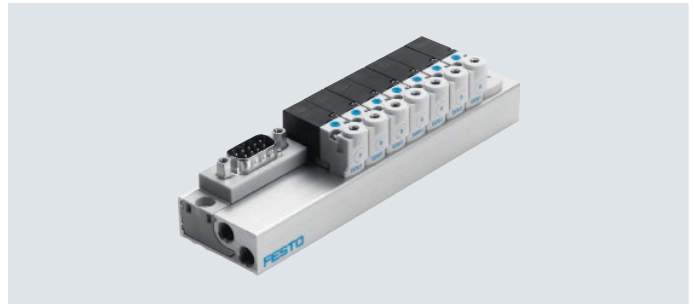

General technical data

Valve terminal design	Fixed grid
Electrical control	Individual connection Multi-pin plug
Maximum number of valve positions	24
Valve function	3/2-way, single solenoid, open 3/2-way, single solenoid, closed 2/2-way, single solenoid, closed
Design	Poppet valve with spring return
Sealing principle	Soft
Actuation type	Electrical
Reset method	Mechanical spring
Type of actuation	Direct
Suitable for vacuum	Yes
Exhaust function	Can be throttled
Signal status indication	LED
Nominal width [mm]	0.9
Maximum standard nominal flow rate [l/min]	10 at 10 mm
Valve size [mm]	10

Operating and environmental conditions

Operating medium	Compressed air to ISO 8573-1:2010 [7:4:4]
Note on the operating/pilot medium	Lubricated operation possible (in which case lubricated operation will always be required)
Operating pressure [bar]	-0.9 ... 8
Ambient temperature [°C]	-5 ... +40
Temperature of medium [°C]	-5 ... +40
Corrosion resistance class CRC ¹⁾	1 - Low corrosion stress
Certification	c UL us - Recognized (OL)
Certificate-issuing authority	UL MH19482
CE marking (see declaration of conformity)	To EU RoHS Directive ²⁾

1) More information www.festo.com/x/topic/crc

2) More information www.festo.com/catalogue/... → Support/Downloads.

Electrical data

Nominal operating voltage	[V DC]	5
	[V DC]	12
	[V DC]	24
	[V AC]	24
Degree of protection	IP40	
	IP65	

Materials

Note on materials	RoHS-compliant Free of copper and PTFE
-------------------	---

Datasheet

Function

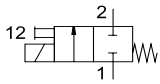
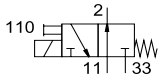
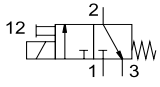

-  - Voltage
5 V DC
12 V DC
24 V DC

-  - Pressure
-0.9 ... +8 bar

-  - Temperature range
-5 ... +40°C

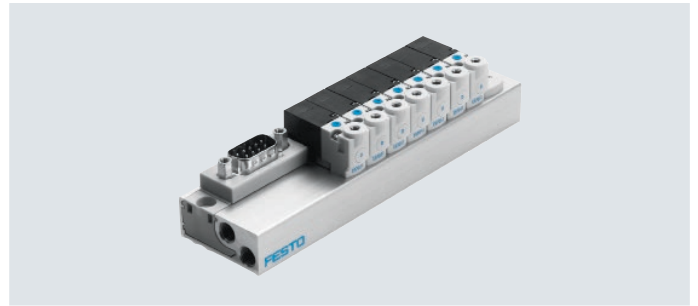

General technical data

Type	MHP1-...-2/2G-...	MHP1-...-3/2G-...	MHP1-...-3/2O-...
Valve function	2/2-way solenoid valve Normally closed Single solenoid	3/2-way solenoid valve Normally closed Single solenoid	3/2-way solenoid valve Normally open Single solenoid
Design	Poppet valve with spring return		
Overlap	Negative overlap		
Sealing principle	Soft		
Actuation type	Electrical		
Reset method	Mechanical spring		
Type of actuation	Direct		
Flow direction	Not reversible		
Suitable for vacuum	Yes	-	-
Exhaust function	Cannot be throttled	Can be throttled	Can be throttled
Manual override	Non-detenting		
Type of mounting	On sub-base via through-hole		
Mounting position	Any		
Valve position identification	Label		
Nominal width	[mm] 0.9	0.65	0.7
Standard nominal flow rate	[l/min] 14	10	10
Width	[mm] 10	10	10
Grid dimension	[mm] 10	10	10
Pneumatic port	1 Sub-base 2 M3 3 - 11 - 33 -	Sub-base M3 Sub-base - -	- M3 - Sub-base Sub-base
Product weight	[g] 10	10	10

Operating and environmental conditions

Type	MHP1-...-2/2G-...	MHP1-...-3/2G-...	MHP1-...-3/2O-...
Operating medium	Compressed air to ISO 8573-1:2010 [7:4:4]		
Note on the operating/pilot medium	Lubricated operation possible (in which case lubricated operation will always be required)		
Operating pressure	[MPa] -0.09 ... +0.2 [bar] -0.9 ... +2 [psi] -13.05 ... +29	0 ... 0.8 ¹⁾ 0 ... 8 ¹⁾ 0 ... 116 ¹⁾	0 ... 0.6 ¹⁾ 0 ... 6 ¹⁾ 0 ... 87 ¹⁾
Ambient temperature	[°C] -5 ... +40		
Temperature of medium	[°C] -5 ... +40		
Storage temperature	[°C] -20 ... +60		
Corrosion resistance class CRC ²⁾	2		
Certification	c UL us - Recognized (OL)		
Certificate-issuing authority	UL MH19482		

1) Vacuum operation possible with special connection method → page 3

2) More information www.festo.com/x/topic/crc

Datasheet

Safety characteristics				
Operating voltage		5 V DC	12 V DC	24 V DC
Note on forced checking procedure		Switching frequency min. 1/week		
Max. positive test pulse with logic 0	[μs]	-	-	500
Max. negative test pulse with logic 1	[μs]	-	-	400
Shock resistance		Shock test with severity level 2 in accordance with FN 942017-5 and EN 60068-2-27		
Vibration resistant		Transport application test with severity level 2 to FN 942017-4 and EN 60068-2-6		

Electrical data			
Operating voltage	[V DC]	5	
	[V DC]	12	
	[V DC]	24	
Permissible voltage fluctuations	[%]	±10	
Electrical connection		Plug	
Electrical power consumption	[W]	1	
Duty cycle	[%]	100	
Degree of protection		IP40	

Switching times and frequencies					
Type			MHP1-...-2/2G-...	MHP1-...-3/2G-...	MHP1-...-3/20-...
Switching time	On	[ms]	4	4	4
	Off	[ms]	5	4	4
Maximum switching frequency		[Hz]	20	20	20

Materials	
Housing	Reinforced PA, reinforced PPS
Seals	FPM, HNBR, NBR
Note on materials	RoHS-compliant
LABS (PWIS) conformity	VDMA24364-B2-L

Dimensions

Download CAD data → www.festo.com

Plug connection on top

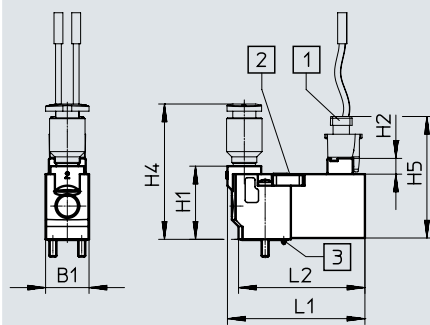

- [1] Plug socket NEBV-H1G2
 [2] Manual override
 [3] Coding pin

Plug connection at the rear

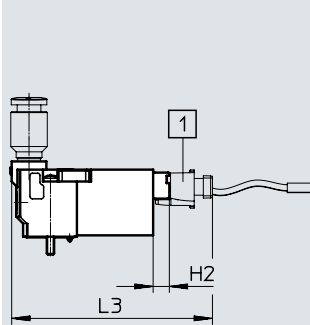

- [1] Plug socket NEBV-H1G2

Plug connection underneath

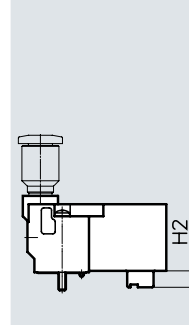

Type	B1	H1	H2	H4	H5	L1	L2	L3
MHP1	9.8	16.5	3.6	30.5	27.4	31	28.5	44

Datasheet

Dimensions – Hole pattern on sub-bases

Download CAD data → www.festo.com

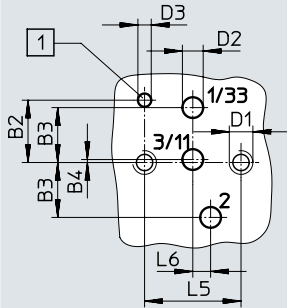

[1] Hole for coding pin

- With semi in-line valves, port 2 is not used.
- If used as a 2/2-way valve, normally closed, ports 3/11 are not used.
- If used as a 2/2-way valve, normally open, ports 1/33 are not used.

Type	B2	B3	B4	D1	D2	D3	L5	L6
MHP1	4.2	3.7	0.2	M1.6	1.4	0.9	6.5	1.2

Dimensions – Assembly on individual sub-base

Download CAD data → www.festo.com

2/2-way valve

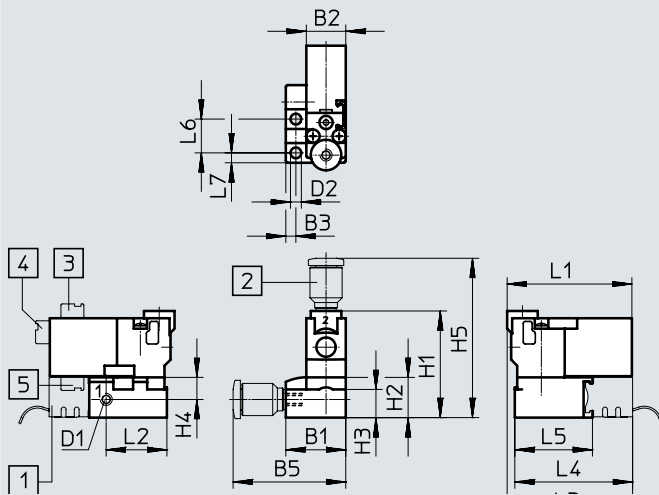

- [1] Plug base MHAP-PI
- [2] Fitting
- [3] Plug connection on top
- [4] Plug connection at the rear
- [5] Plug connection underneath

3/2-way valve

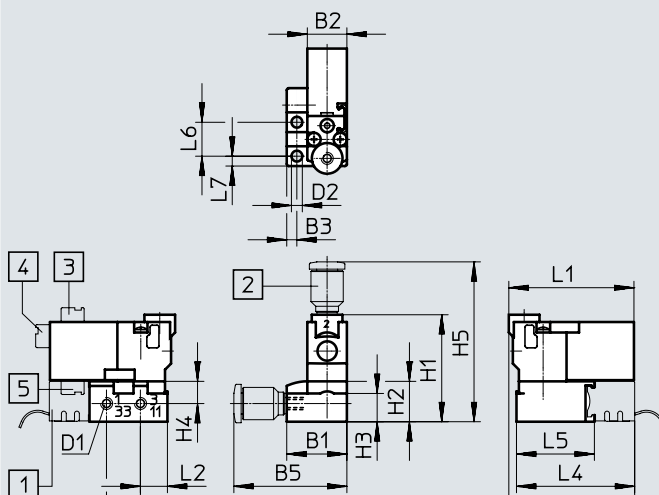

- [1] Plug base MHAP-PI
- [2] Fitting
- [3] Plug connection on top
- [4] Plug connection at the rear
- [5] Plug connection underneath

Type	B1	B2	B3	B5	D1	D2	H1	H2	H3	H4	H5	L1	L2	L3	L4	L5	L6	L7	L7
2/2-way valve	14.9	9.8	2.5	28	M3	2.7	26.5	10	7	5.5	39.6	31	15.1	31.2	29.3	19.3	8.4	2.5	2.5
3/2-way valve	14.9	9.8	2.5	28	M3	2.7	26.5	10	7	5.5	39.6	31	6.7	31.2	29.3	19.3	8.4	2.5	8.4

Datasheet

Dimensions – Manifold assembly

Download CAD data → www.festo.com

2/2-way valve

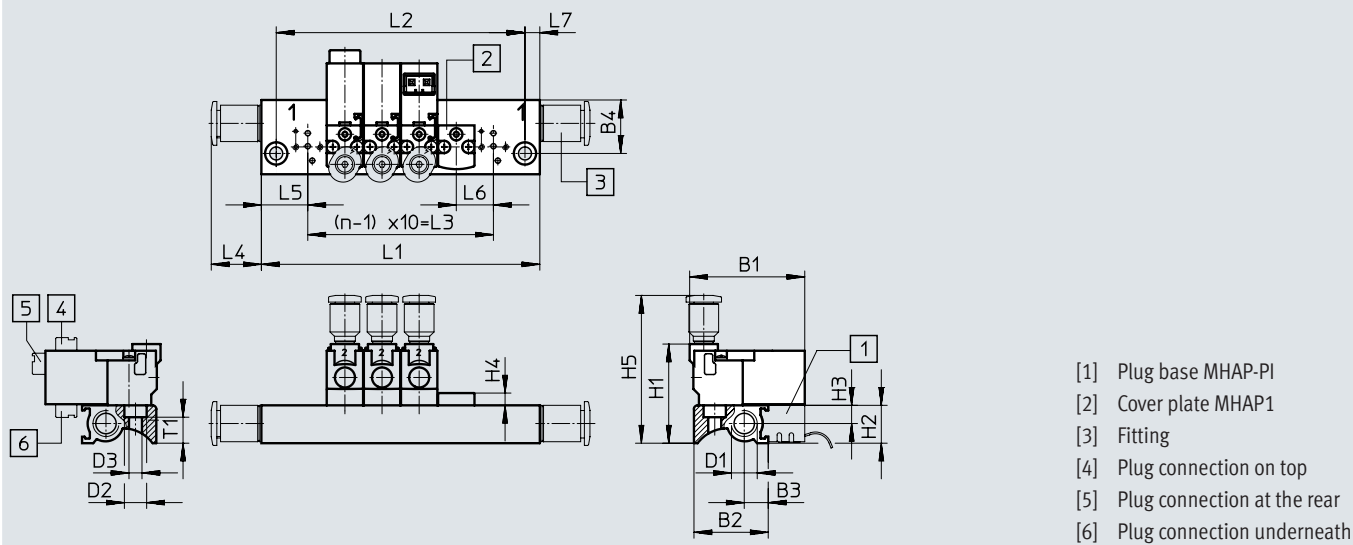

3/2-way valve

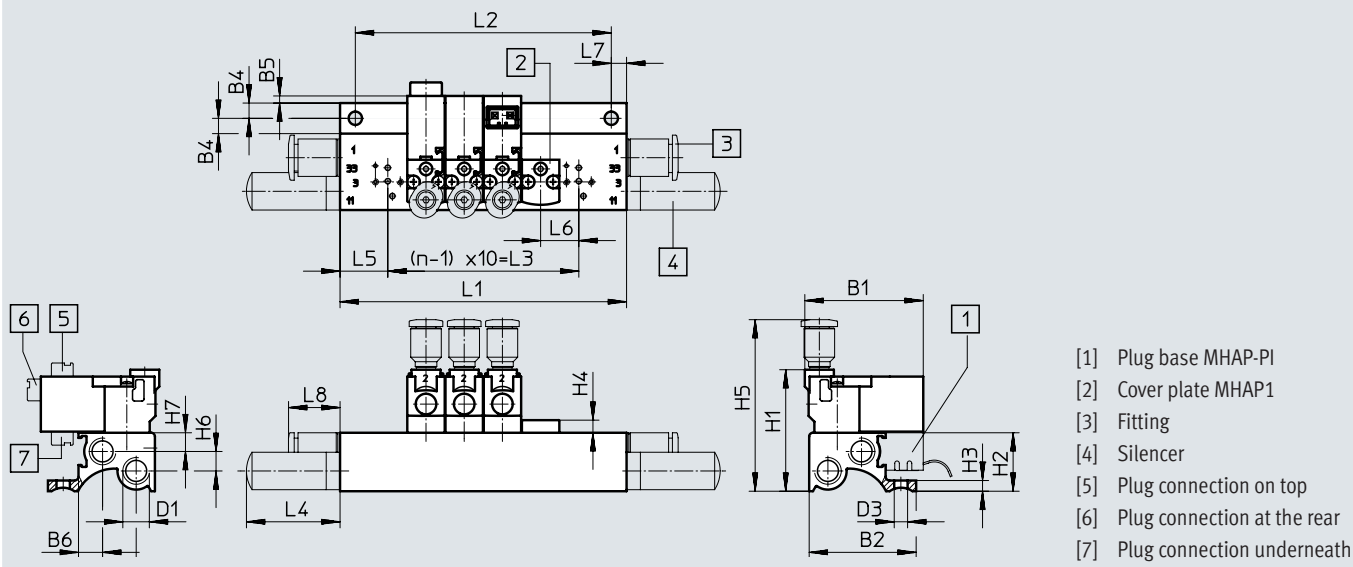

Type	B1	B2	B3	B4	B5	B6	D1	D2	D3	H1	H2	H3	H4	H5	H6	H7	L4	L5	L6	L7	L8	T1
2/2-way valve	31	20	6.3	14.4	-	-	M7	6	3.5	26.7	10.2	4.9	3.3	39.8	-	-	13.5	12.5	10	4	-	7
3/2-way valve	31	28	8.8	4	1.9	6.3	M7	-	3.5	31.8	15.3	2.8	3.3	44.9	5.1	4.9	24.5	12.5	10	4	13.5	-

Valve positions n	L1 ±0.15	L2 ±0.1	L3
2	35	27	10
3	45	37	20
4	55	47	30
5	65	57	40
6	75	67	50
7	85	77	60
8	95	87	70

Valve positions n	L1 ±0.15	L2 ±0.1	L3
9	105	97	80
10	115	107	90
11	125	117	100
12	135	127	110
13	145	137	120
14	155	147	130
15	165	157	140

Valve positions n	L1 ±0.15	L2 ±0.1	L3
16	175	167	150
17	185	177	160
18	195	187	170
19	205	197	180
20	215	207	190
21	225	217	200
22	235	227	210

Datasheet

Dimensions – Manifold assembly with electrical multi-pin plug

Download CAD data → www.festo.com

3/2-way valve

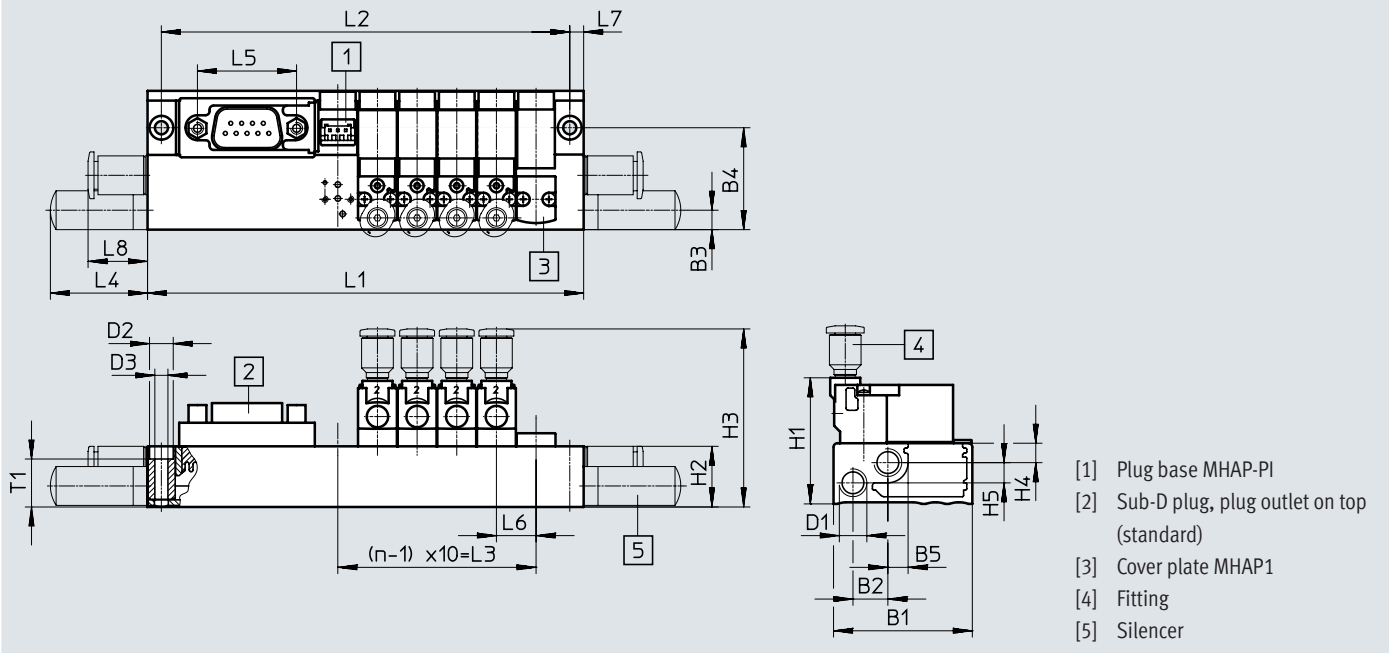

Type	B1	B2	B3	B4	B5	D1	D2	D3	H1	H2	H3	H4	H5	L4	L5	L6	L7	L8	T1
MHP1	35	8.8	5.3	25.7	5.2	M7	6	3.3	31.8	15.3	44.9	4.9	5.1	54.5	25	10	3.5	15	12.1

Valve positions n	L1 ±0.15	L2 ±0.1	L3
2	70	63	10
4	90	83	30
6	110	103	50
8	130	123	70

Valve positions n	L1 ±0.15	L2 ±0.1	L3
10	172	165	90
12	192	185	110
14	212	205	130
16	232	225	150

Valve positions n	L1 ±0.15	L2 ±0.1	L3
18	252	245	170
20	272	265	190
22	292	285	210

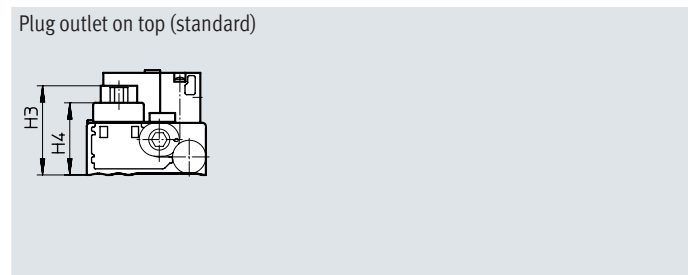
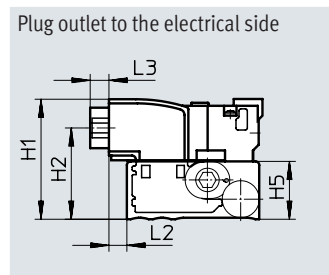
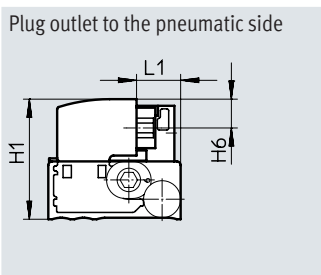

Type	H1	H2	H3	H4	H5	H6	L1	L2	L3
MHP1	31.8	24.2	26.2	21.2	15.3	7.6	11.7	4.8	5

Datasheet

Dimensions – Manifold assembly on a circuit board

Download CAD data → www.festo.com

3/2-way valve

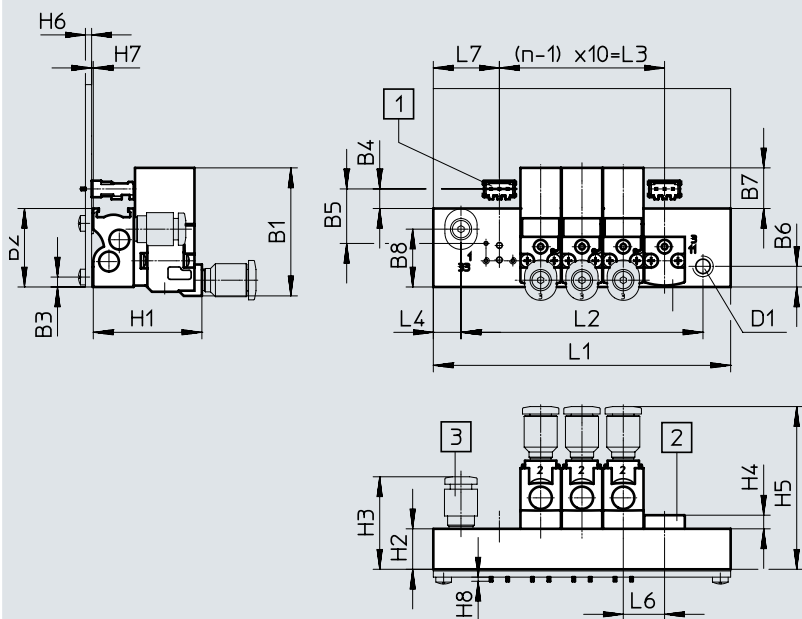

- [1] Soldering base PCBC-A
- [2] Cover plate MHAP1
- [3] Fitting

Type	B1	B2	B3	B4	B5	B6	B7	B8	D1	H1	H2	H3	H4	H5	H6	H7	H8	L4	L6	L7
MHP1	31	19	2.4	4.8	13.2	5	9.9	14	M5	26.3	9.8	22.4	3.3	39.4	1.5	0.4	1	6.7	10	16

Valve positions n	L1 ±0.15	L2 ±0.1	L3
2	42	28.6	10
4	62	48.6	30
6	82	68.6	50
8	102	88.6	70
10	122	108.6	90

Hole pattern on circuit board

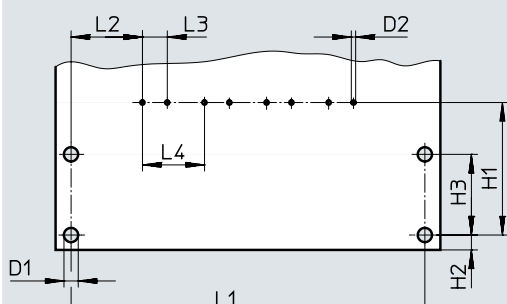



Note
The circuit board is not included in the scope of delivery.

Type	D1	D2	H1	H2	H3	L2	L3	L4
Circuit board	2.3	0.7	21.4	2.4	13	11.5	4	10

Valve positions n	L1 ±0.1
2	37
4	57
6	77
8	97
10	117

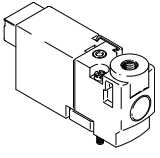
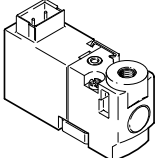
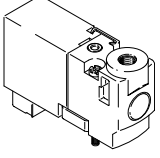



Datasheet

Ordering data		Valve function	Normal position		Part no.	Type
Solenoid valve						
	Plug connection at the rear	2/2-way solenoid valve	Closed	5 V DC	197045	MHP1-M4H-2/2G-M3-HC
				12 V DC	197046	MHP1-M5H-2/2G-M3-HC
				24 V DC	197047	MHP1-M1H-2/2G-M3-HC
		3/2-way solenoid valve	Closed	5 V DC	197009	MHP1-M4H-3/2G-M3-HC
				12 V DC	197010	MHP1-M5H-3/2G-M3-HC
				24 V DC	197011	MHP1-M1H-3/2G-M3-HC
			Open	5 V DC	197027	MHP1-M4H-3/2O-M3-HC
				12 V DC	197028	MHP1-M5H-3/2O-M3-HC
				24 V DC	197029	MHP1-M1H-3/2O-M3-HC
	Plug connection on top	2/2-way solenoid valve	Closed	5 V DC	197048	MHP1-M4H-2/2G-M3-TC
				12 V DC	197049	MHP1-M5H-2/2G-M3-TC
				24 V DC	197050	MHP1-M1H-2/2G-M3-TC
		3/2-way solenoid valve	Closed	5 V DC	197012	MHP1-M4H-3/2G-M3-TC
				12 V DC	197013	MHP1-M5H-3/2G-M3-TC
				24 V DC	197014	MHP1-M1H-3/2G-M3-TC
			Open	5 V DC	197030	MHP1-M4H-3/2O-M3-TC
				12 V DC	197031	MHP1-M5H-3/2O-M3-TC
				24 V DC	197032	MHP1-M1H-3/2O-M3-TC
	Plug connection underneath	2/2-way solenoid valve	Closed	5 V DC	197051	MHP1-M4H-2/2G-M3-PI
				12 V DC	197052	MHP1-M5H-2/2G-M3-PI
				24 V DC	197053	MHP1-M1H-2/2G-M3-PI
		3/2-way solenoid valve	Closed	5 V DC	197015	MHP1-M4H-3/2G-M3-PI
				12 V DC	197016	MHP1-M5H-3/2G-M3-PI
				24 V DC	197017	MHP1-M1H-3/2G-M3-PI
			Open	5 V DC	197033	MHP1-M4H-3/2O-M3-PI
				12 V DC	197034	MHP1-M5H-3/2O-M3-PI
				24 V DC	197035	MHP1-M1H-3/2O-M3-PI

 **Note**

Valves types 3/2G and 3/2O must not be mixed on one manifold rail.

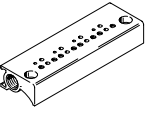
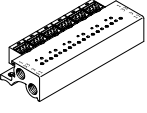
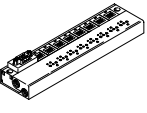
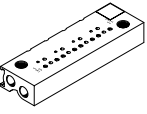
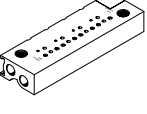
Datasheet

Ordering data				Part no.	Type
Individual sub-base					
	For valves with plug connection at the rear or on top	For 2/2-way solenoid valve	1 valve position	197188	MHP1-AS-2-M3
		For 3/2-way solenoid valve	1 valve position	197184	MHP1-AS-3-M3
	For valves with plug connection underneath	For 2/2-way solenoid valve	1 valve position	197190	MHP1-AS-2-M3-PI
		For 3/2-way solenoid valve	1 valve position	197186	MHP1-AS-3-M3-PI
Manifold rail, for valves with plug connection at the rear or on top					
	Without plug bases	For 2/2-way solenoid valve	2 valves	197196	MHP1-P2-2
			4 valves	197197	MHP1-P4-2
			6 valves	197198	MHP1-P6-2
			8 valves	197200	MHP1-P8-2
			10 valves	197201	MHP1-P10-2
		For 3/2-way solenoid valve	2 valves	197191	MHP1-PR2-3
			4 valves	197192	MHP1-PR4-3
			6 valves	197193	MHP1-PR6-3
			8 valves	197194	MHP1-PR8-3
			10 valves	197195	MHP1-PR10-3
Manifold rail, for valves with plug connection underneath					
	With plug bases	For 2/2-way solenoid valve	2 valves	197217	MHP1-P2-2-PI
			4 valves	197218	MHP1-P4-2-PI
			6 valves	197219	MHP1-P6-2-PI
			8 valves	197220	MHP1-P8-2-PI
			10 valves	197221	MHP1-P10-2-PI
		For 3/2-way solenoid valve	2 valves	197212	MHP1-PR2-3-PI
			4 valves	197213	MHP1-PR4-3-PI
			6 valves	197214	MHP1-PR6-3-PI
			8 valves	197215	MHP1-PR8-3-PI
			10 valves	197216	MHP1-PR10-3-PI
	With plug bases and electrical multi-pin plug, Sub-D, 9-pin	For 3/2-way solenoid valve	4 valves	197233	MHP1-PR4-3-PI-D9
			6 valves	197234	MHP1-PR6-3-PI-D9
			8 valves	197235	MHP1-PR8-3-PI-D9
	With plug bases and electrical multi-pin plug, Sub-D, 25-pin	For 3/2-way solenoid valve	10 valves	197236	MHP1-PR10-3-PI-D25
	Without plug bases, for mounting on a circuit board	For 3/2-way solenoid valve	2 valves	197242	MHP1-PR2-3-PI-PCB
			4 valves	197243	MHP1-PR4-3-PI-PCB
			6 valves	197244	MHP1-PR6-3-PI-PCB
			8 valves	197245	MHP1-PR8-3-PI-PCB
			10 valves	197246	MHP1-PR10-3-PI-PCB
Cover plate					
	For manifold rail without plug bases			197257	MHAP1-BP-3
	For manifold rail with plug bases			197258	MHAP1-BP-3-PI



 - **Note**

Manifold rails with an uneven number of valves and for 11 ... 24 valves as well as further variants can be configured and ordered online via the modular product system for MH1.

 - **Note**

Valves types 3/2G and 3/2O must not be mixed on one manifold rail.

Datasheet

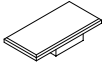
Ordering data				Pack size	Part no.	Type
Blanking plug						
	For M3 thread			10	30979	B-M3-S9
	For M7 thread			10	174309	B-M7
Silencer						
	M3 connecting thread			20	1231120	AMTE-M-LH-M3
	M7 connecting thread			1	161418	UC-M7
Push-in fitting						
	M3 connecting thread	With internal hex	For tubing O.D. 3 mm	10	153312	QSM-M3-3-I
			For tubing O.D. 4 mm	10	153314	QSM-M3-4-I
		With external hex	For tubing O.D. 3 mm	10	153301	QSM-M3-3
			For tubing O.D. 4 mm	10	153303	QSM-M3-4
	M5 connecting thread	With internal hex	For tubing O.D. 3 mm	10	153313	QSM-M5-3-I
			For tubing O.D. 4 mm	10	153315	QSM-M5-4-I
			For tubing O.D. 6 mm	10	153317	QSM-M5-6-I
		With external hex	For tubing O.D. 3 mm	10	153302	QSM-M5-3
			For tubing O.D. 4 mm	10	153304	QSM-M5-4
			For tubing O.D. 6 mm	10	153306	QSM-M5-6
	M7 connecting thread	With internal hex	For tubing O.D. 4 mm	10	153319	QSM-M7-4-I
			For tubing O.D. 6 mm	10	153321	QSM-M7-6-I
Inscription label						
	For identifying the valve positions			–	197259	MH-BZ-80X

Datasheet

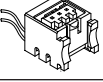
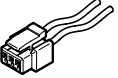
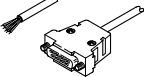
Ordering data				Pack size	Part no.	Type	
Soldering base							
	For manifold rail for valves with plug connection underneath for mounting on a circuit board, 3-pin			10	197261	PCBC-A-10	
				100	197262	PCBC-A-100	
Electrical plug base							
	For manifold rail, for valves with plug connection underneath	2x stranded conductors Open end 1-core		0.5 m	–	197260	MHAP-PI
				1 m	–	532182	MHAP-PI-1
Plug socket with cable							
	Straight socket Plug pattern H 3-pin	2x stranded conductors Open end 1-core		0.5 m	–	566654	NEBV-H1G2-KN-0.5-N-LE2
				1 m	–	566655	NEBV-H1G2-KN-1-N-LE2
				2.5 m	–	566656	NEBV-H1G2-KN-2.5-N-LE2
				5 m	–	566657	NEBV-H1G2-KN-5-N-LE2
Connecting cable for manifold rail with electrical multi-pin plug							
	Straight socket, Sub-D, 9-pin	Cable Open end 9-core		2.5 m	–	531184	KMP6-09P-8-2.5
				5 m	–	531185	KMP6-09P-8-5
				10 m	–	531186	KMP6-09P-8-10
	Straight socket, Sub-D, 25-pin	Cable Open end 15-core		2.5 m	–	530049	KMP6-25P-12-2.5
				5 m	–	530050	KMP6-25P-12-5
				10 m	–	530051	KMP6-25P-12-10
	Straight socket, Sub-D, 25-pin	Cable Open end 25-core		2.5 m	–	530046	KMP6-25P-20-2.5
				5 m	–	530047	KMP6-25P-20-5
				10 m	–	530048	KMP6-25P-20-10

Datasheet

Function

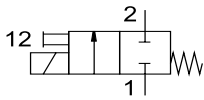
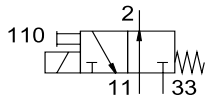
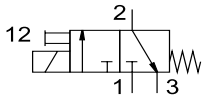

-  - Voltage
5 V DC
12 V DC
24 V DC

-  - Pressure
-0.9 ... +8 bar

-  - Temperature range
-5 ... +40°C

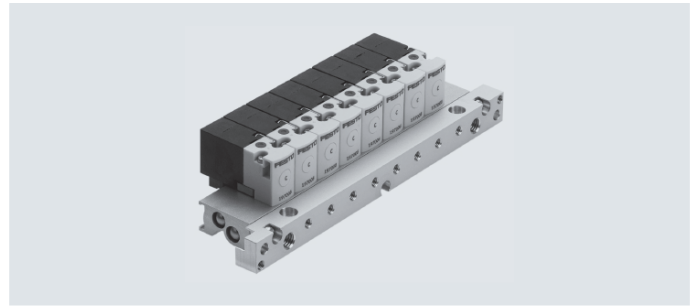

General technical data			
Type	MHA1-...-2/2G-...	MHA1-...-3/2G-...	MHA1-...-3/20-...
Valve function	2/2-way solenoid valve	3/2-way solenoid valve	3/2-way solenoid valve
	Normally closed	Normally closed	Normally open
	Single solenoid	Single solenoid	Single solenoid
Design	Poppet valve with spring return		
Overlap	Negative overlap		
Sealing principle	Soft		
Actuation type	Electrical		
Reset method	Mechanical spring		
Type of actuation	Direct		
Flow direction	Not reversible		
Suitable for vacuum	Yes	-	-
Exhaust function	Cannot be throttled	Can be throttled	Can be throttled
Manual override	Non-detenting		
Type of mounting	On sub-base via through-hole		
Mounting position	Any		
Valve position identification	Label		
Nominal width	[mm] 0.9	0.65	0.7
Standard nominal flow rate	[l/min] 14	10	10
Width	[mm] 10	10	10
Grid dimension	[mm] 10	10	10
Pneumatic port	1	Sub-base	-
	2	Sub-base	Sub-base
	3	-	Sub-base
	11	-	Sub-base
	33	-	Sub-base
Product weight	[g] 10	10	10

Operating and environmental conditions			
Type	MHA1-...-2/2G-...	MHA1-...-3/2G-...	MHA1-...-3/20-...
Operating medium	Compressed air to ISO 8573-1:2010 [7:4:4]		
Note on the operating/pilot medium	Lubricated operation possible (in which case lubricated operation will always be required)		
Operating pressure	[MPa]	-0.09 ... +0.2	0 ... 0.8 ¹⁾
	[bar]	-0.9 ... +2	0 ... 8 ¹⁾
	[psi]	-13.05 ... +29	0 ... 116 ¹⁾
Ambient temperature	[°C]	-5 ... +40	
Temperature of medium	[°C]	-5 ... +40	
Storage temperature	[°C]	-20 ... +60	
Corrosion resistance class CRC ²⁾	2		
Certification	c UL us - Recognized (OL)		
Certificate-issuing authority	UL MH19482		

1) Vacuum operation possible with special connection method → page 3

2) More information www.festo.com/x/topic/crc

Datasheet

Safety characteristics				
Operating voltage		5 V DC	12 V DC	24 V DC
Note on forced checking procedure	Switching frequency min. 1/week			
Max. positive test pulse with logic 0	[μs]	–	–	500
Max. negative test pulse with logic 1	[μs]	–	–	400
Shock resistance	Shock test with severity level 2 in accordance with FN 942017-5 and EN 60068-2-27			
Vibration resistant	Transport application test with severity level 2 to FN 942017-4 and EN 60068-2-6			

Electrical data		
Operating voltage	[V DC]	5
	[V DC]	12
	[V DC]	24
Permissible voltage fluctuations	[%]	±10
Electrical connection		Plug
Electrical power consumption	[W]	1
Duty cycle	[%]	100
Degree of protection		IP40

Switching times and frequencies					
Type			MHA1-...-2/2G-...	MHA1-...-3/2G-...	MHA1-...-3/20-...
Switching time	On	[ms]	4	4	4
	Off	[ms]	5	4	4
Maximum switching frequency		[Hz]	20	20	20

Materials	
Housing	Reinforced PA, reinforced PPS
Sub-base	Aluminium
Seals	FPM, HNBR, NBR
Note on materials	RoHS-compliant
LABS (PWIS) conformity	VDMA24364-B2-L

Dimensions

Download CAD data → www.festo.com

Plug connection on top

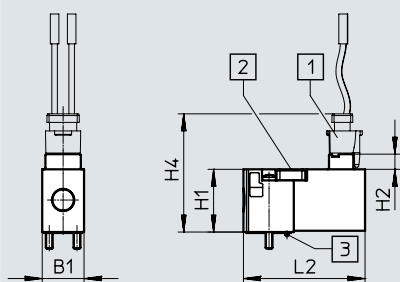

- [1] Plug socket NEBV-H1G2 [2] Manual override
[3] Coding pin

Plug connection at the rear

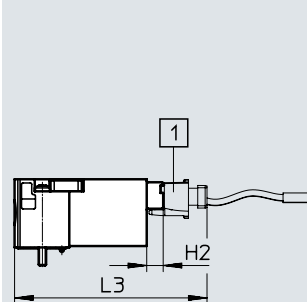

- [1] Plug socket NEBV-H1G2

Plug connection underneath

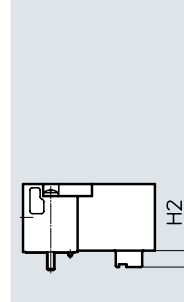

Type	B1	H1	H2	H4	L2	L3
MHA1	9.8	14.7	3.6	27.7	28.5	41.5

Datasheet

Dimensions – Hole pattern on sub-bases

Download CAD data → www.festo.com

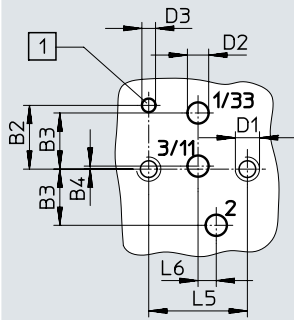

[1] Hole for coding pin

- If used as a 2/2-way valve, normally closed, ports 3/11 are not used.
- If used as a 2/2-way valve, normally open, ports 1/33 are not used.

Type	B2	B3	B4	D1	D2	D3	L5	L6
MHA1	4.2	3.7	0.2	M1.6	1.4	0.9	6.5	1.2

Dimensions – Assembly on individual sub-base

Download CAD data → www.festo.com

2/2-way valve

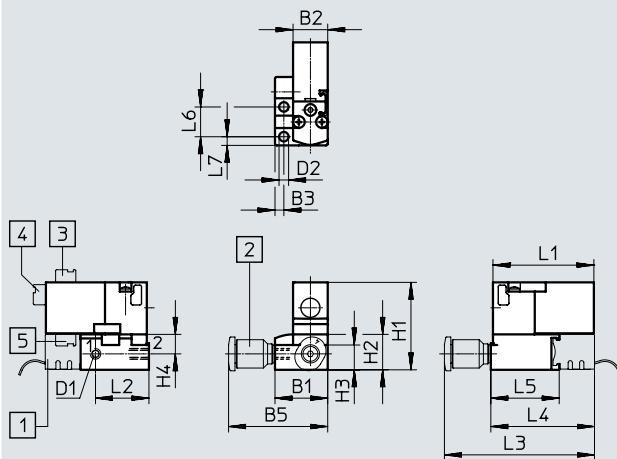

- [1] Plug base MHAP-PI
- [2] Fitting
- [3] Plug connection on top
- [4] Plug connection at the rear
- [5] Plug connection underneath

3/2-way valve

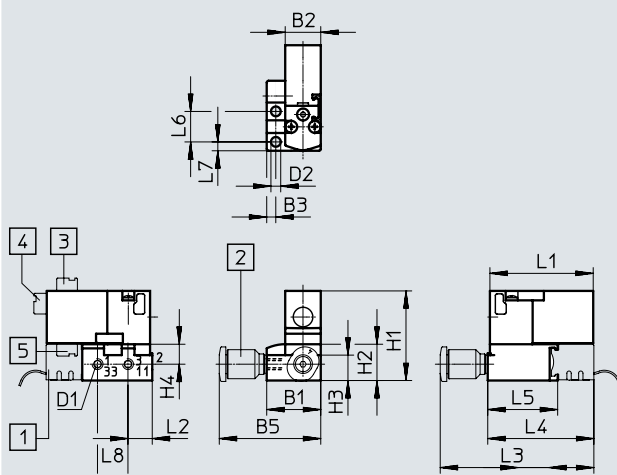

- [1] Plug base MHAP-PI
- [2] Fitting
- [3] Plug connection on top
- [4] Plug connection at the rear
- [5] Plug connection underneath

Type	B1	B2	B3	B4	B5	D1	D2	H1	H2	H3	H4	L1	L2	L3	L4	L5	L6	L7	L8
2/2-way valve	14.9	9.8	2.5	14.9	28	M3	2.7	24.7	10	7	5.5	28.5	15.1	42.4	29.3	19.3	8.4	2.5	–
3/2-way valve	14.9	9.8	2.5	14.9	28	M3	2.7	24.7	10	7	5.5	28.5	6.7	42.4	29.3	19.3	8.4	2.5	8.4

Datasheet

Dimensions – Manifold assembly

Download CAD data → www.festo.com

2/2-way valve

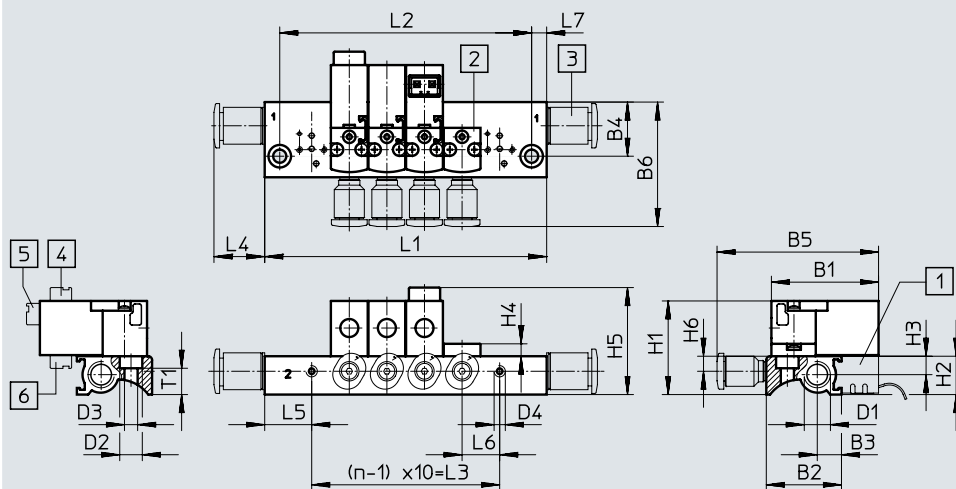

- [1] Plug base MHAP-PI
- [2] Cover plate MHAP1
- [3] Fitting
- [4] Plug connection on top
- [5] Plug connection at the rear
- [6] Plug connection underneath

3/2-way valve

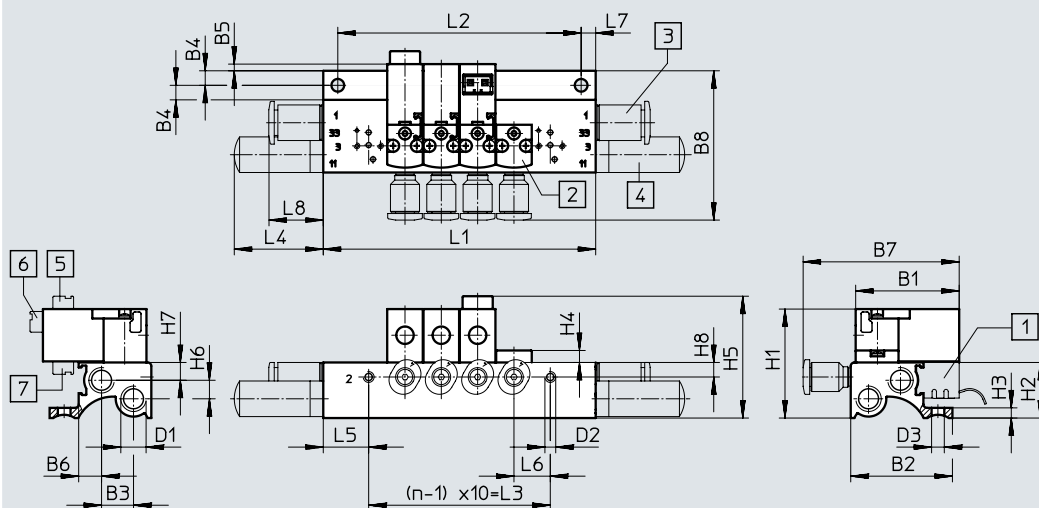

- [1] Plug base MHAP-PI
- [2] Cover plate MHAP1
- [3] Fitting
- [4] Silencer
- [5] Plug connection on top
- [6] Plug connection at the rear
- [7] Plug connection underneath

Type	B1	B2	B3	B4	B5	B6	B7	B8	D1	D2	D3	D4
2/2-way valve	28.5	20	6.3	14.4	42.9	33.1	–	–	M7	6	3.5	M3
3/2-way valve	28.5	28	8.8	4	1.9	6.3	42.9	41.1	M7	M3	3.5	–

Type	H1	H2	H3	H4	H5	H6	H7	H8	L4	L5	L6	L7	L8	T1
2/2-way valve	24.9	10.2	4.9	3.3	28.5	4	–	–	13.5	12.5	10	4	–	7
3/2-way valve	30	15.3	2.8	3.3	33.6	5.1	4.9	4	24.5	12.5	10	4	13.5	–

Valve positions n	L1 ±0.15	L2 ±0.1	L3
2	35	27	10
3	45	37	20
4	55	47	30
5	65	57	40
6	75	67	50
7	85	77	60
8	95	87	70

Valve positions n	L1 ±0.15	L2 ±0.1	L3
9	105	97	80
10	115	107	90
11	125	117	100
12	135	127	110
13	145	137	120
14	155	147	130
15	165	157	140

Valve positions n	L1 ±0.15	L2 ±0.1	L3
16	175	167	150
17	185	177	160
18	195	187	170
19	205	197	180
20	215	207	190
21	225	217	200
22	235	227	210

Datasheet

Dimensions – Manifold assembly with electrical multi-pin plug

Download CAD data → www.festo.com

3/2-way valve

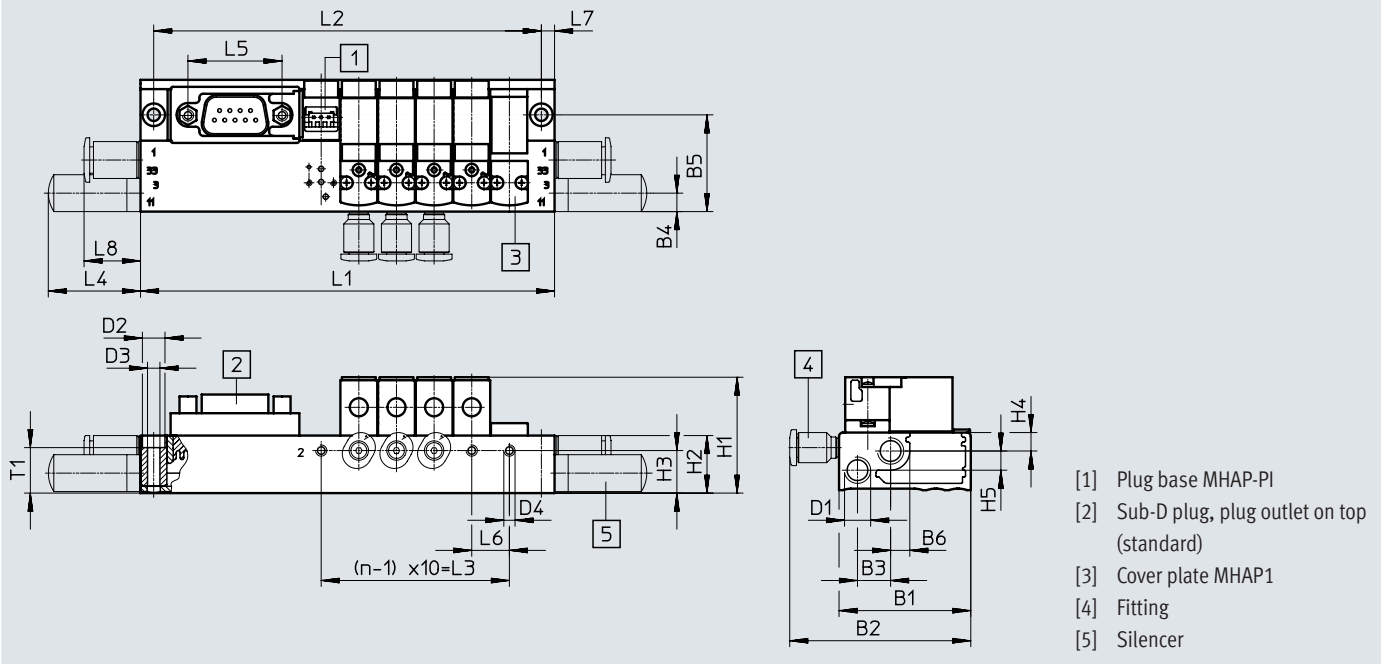

Type	B1	B2	B3	B4	B5	B6	D1	D2	D3	D4	H1	H2	H3	H4	H5	L4	L5	L6	L7	L8	T1
MHA1	35	48.1	8.8	5.3	25.7	5.2	M7	6	3.3	M3	30.8	15.3	11.3	4.9	5.1	24.5	25	10	3.5	15	12.1

Valve positions n	L1 ±0.15	L2 ±0.1	L3	Valve positions n	L1 ±0.15	L2 ±0.1	L3	Valve positions n	L1 ±0.15	L2 ±0.1	L3
2	70	63	10	10	172	165	90	18	252	245	170
4	90	83	30	12	192	185	110	20	272	265	190
6	110	103	50	14	212	205	130	22	292	285	210
8	130	123	70	16	232	225	150				

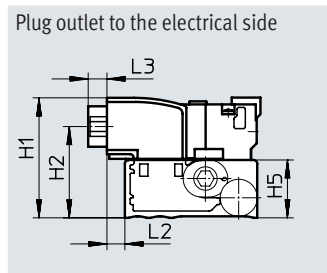
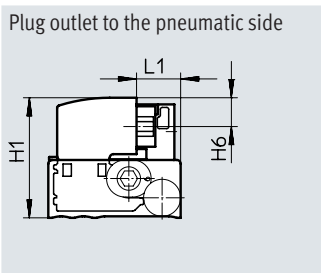

Type	H1	H2	H3	H4	H5	H6	L1	L2	L3
MHA1	31.8	24.2	26.2	21.2	15.3	7.6	11.7	4.8	5

Datasheet

Dimensions – Manifold assembly on a circuit board

Download CAD data → www.festo.com

3/2-way valve, without pneumatic multiple connector plate

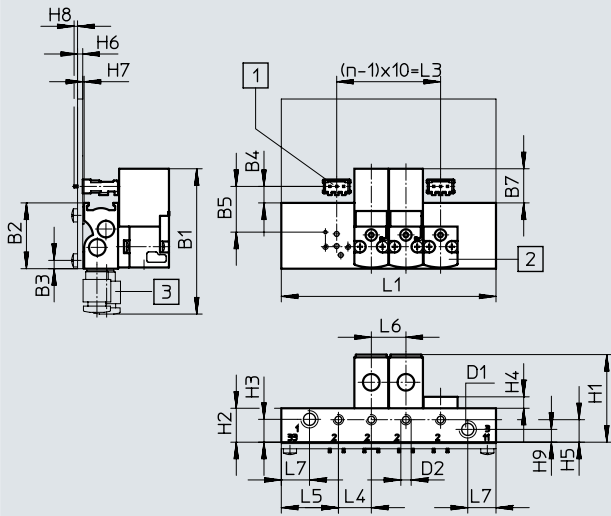

- [1] Soldering base PCBC-A
- [2] Cover plate MHAP1
- [3] Fitting

 **Note**
The circuit board is not included in the scope of delivery.

Type	B1	B2	B3	B4	B5	B7	D1	D2
Without pneumatic multiple connector plate	42	19	2.4	4.8	13.2	9.9	M5	M3

Type	H1	H2	H3	H4	H5	H6	H7	H8	H9	L4	L5	L6	L7
Without pneumatic multiple connector plate	25.3	9.8	6.6	3.3	6.5	1.5	0.4	1	3.7	9.5	16.5	10	8.2

Valve positions n	L1 ±0.15	L3
2	42	10
4	62	30
6	82	50
8	102	70
10	122	90

Datasheet

Dimensions – Manifold assembly on a circuit board

Download CAD data → www.festo.com

3/2-way valve, with pneumatic multiple connector plate

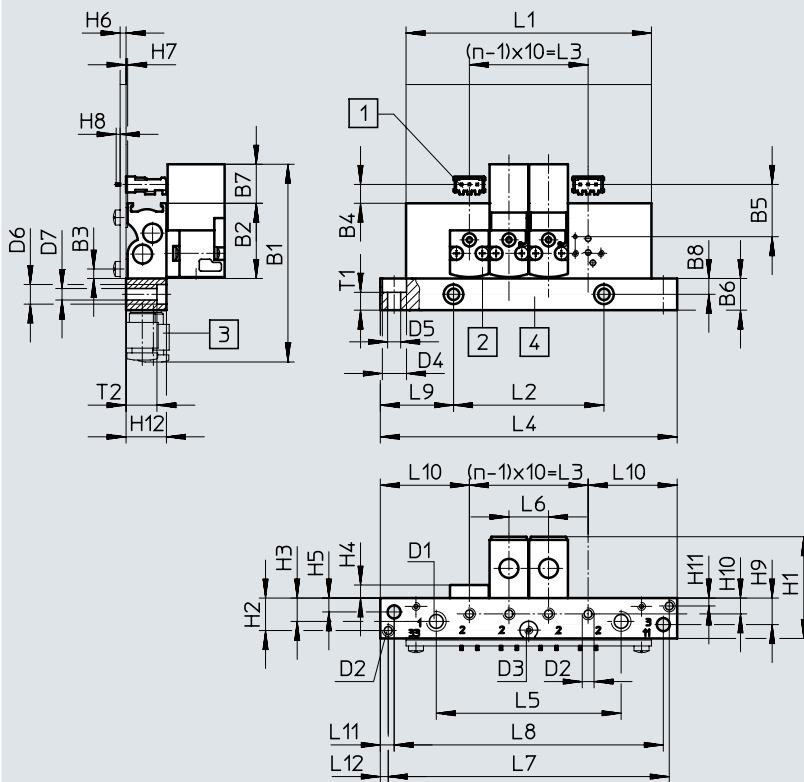

- [1] Soldering base PCBC-A
- [2] Cover plate MHAP1
- [3] Fitting
- [4] Pneumatic multiple connector plate, removable

Note
The circuit board is not included in the scope of delivery.

Type	B1	B2	B3	B4	B5	B6	B7	B8	D1	D2	D3	D4	D5	D6	D7
With pneumatic multiple connector plate	49.5	19	2.4	4.8	13.2	8	9.9	4	M5	M3	M2	6.1	3.3	5	2.9

Type	H1	H2	H3	H4	H5	H6	H7	H8	H9	H10	H11	H12	L6	L9	L10	L11	L12	T1	T2
With pneumatic multiple connector plate	25.7	8.2	5.9	3.3	3.5	1.5	0.4	1	6.7	4	2	10.2	10	18.5	22.5	3.5	2	4.5	7.8

Valve positions n	L1 ±0.15	L2 ±0.1	L3	L4 ±0.2	L5 ±0.15	L7 ±0.1	L8
4	62	38	30	75	46.7	71	68
6	82	58	50	95	66.7	91	88
8	102	78	70	115	86.7	111	108
10	122	98	90	135	106.7	131	128

Datasheet

Dimensions – Manifold assembly on a circuit board

Download CAD data → www.festo.com

Hole pattern on circuit board

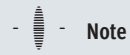
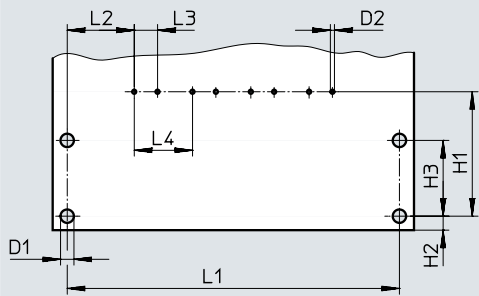

Note

The circuit board is not included in the scope of delivery.

Type	D1	D2	H1	H2	H3	L2	L3	L4
Circuit board	2.3	0.7	21.4	2.4	13	11.5	4	10

Valve positions n	L1 ±0.1
2	37
4	57
6	77
8	97
10	117

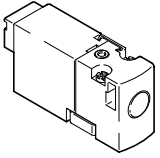
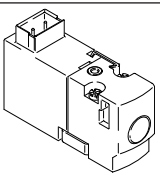
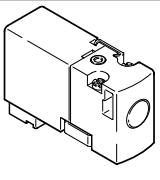

Datasheet

Ordering data		Valve function	Normal position		Part no.	Type
Solenoid valve						
	Plug connection at the rear	2/2-way solenoid valve	Closed	5 V DC	197036	MHA1-M4H-2/2G-0.9-HC
				12 V DC	197037	MHA1-M5H-2/2G-0.9-HC
				24 V DC	197038	MHA1-M1H-2/2G-0.9-HC
		3/2-way solenoid valve	Closed	5 V DC	197000	MHA1-M4H-3/2G-0.6-HC
				12 V DC	197001	MHA1-M5H-3/2G-0.6-HC
				24 V DC	197002	MHA1-M1H-3/2G-0.6-HC
			Open	5 V DC	197018	MHA1-M4H-3/2O-0.6-HC
				12 V DC	197019	MHA1-M5H-3/2O-0.6-HC
				24 V DC	197020	MHA1-M1H-3/2O-0.6-HC
	Plug connection on top	2/2-way solenoid valve	Closed	5 V DC	197039	MHA1-M4H-2/2G-0.9-TC
				12 V DC	197040	MHA1-M5H-2/2G-0.9-TC
				24 V DC	197041	MHA1-M1H-2/2G-0.9-TC
		3/2-way solenoid valve	Closed	5 V DC	197003	MHA1-M4H-3/2G-0.6-TC
				12 V DC	197004	MHA1-M5H-3/2G-0.6-TC
				24 V DC	197005	MHA1-M1H-3/2G-0.6-TC
			Open	5 V DC	197021	MHA1-M4H-3/2O-0.6-TC
				12 V DC	197022	MHA1-M5H-3/2O-0.6-TC
				24 V DC	197023	MHA1-M1H-3/2O-0.6-TC
	Plug connection underneath	2/2-way solenoid valve	Closed	5 V DC	197042	MHA1-M4H-2/2G-0.9-PI
				12 V DC	197043	MHA1-M5H-2/2G-0.9-PI
				24 V DC	197044	MHA1-M1H-2/2G-0.9-PI
		3/2-way solenoid valve	Closed	5 V DC	197006	MHA1-M4H-3/2G-0.6-PI
				12 V DC	197007	MHA1-M5H-3/2G-0.6-PI
				24 V DC	197008	MHA1-M1H-3/2G-0.6-PI
			Open	5 V DC	197024	MHA1-M4H-3/2O-0.6-PI
				12 V DC	197025	MHA1-M5H-3/2O-0.6-PI
				24 V DC	197026	MHA1-M1H-3/2O-0.6-PI

 **Note**

Valves types 3/2G and 3/2O must not be mixed on a manifold rail.



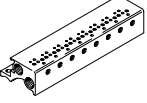
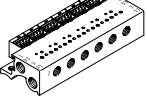
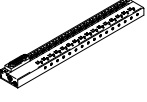
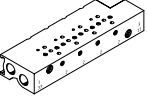
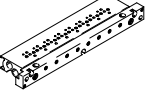

Datasheet

Ordering data				Part no.	Type
Individual sub-base					
	For valves with plug connection at the rear or on top	For 2/2-way solenoid valve	1 valve position	197187	MHA1-AS-2-M3
		For 3/2-way solenoid valve	1 valve position	197183	MHA1-AS-3-M3
	For valves with plug connection underneath	For 2/2-way solenoid valve	1 valve position	197189	MHA1-AS-2-M3-PI
		For 3/2-way solenoid valve	1 valve position	197185	MHA1-AS-3-M3-PI
Manifold rail, for valves with plug connection at the rear or on top					
	Without plug bases	For 2/2-way solenoid valve	2 valves	197207	MHA1-P2-2-M3
			4 valves	197208	MHA1-P4-2-M3
			6 valves	197209	MHA1-P6-2-M3
			8 valves	197210	MHA1-P8-2-M3
			10 valves	197211	MHA1-P10-2-M3
		For 3/2-way solenoid valve	2 valves	197202	MHA1-PR2-3-M3
			4 valves	197203	MHA1-PR4-3-M3
			6 valves	197204	MHA1-PR6-3-M3
			8 valves	197205	MHA1-PR8-3-M3
			10 valves	197206	MHA1-PR10-3-M3
Manifold rail, for valves with plug connection underneath					
	With plug bases	For 2/2-way solenoid valve	2 valves	197227	MHA1-P2-2-M3-PI
			4 valves	197228	MHA1-P4-2-M3-PI
			6 valves	197229	MHA1-P6-2-M3-PI
			8 valves	197230	MHA1-P8-2-M3-PI
			10 valves	197231	MHA1-P10-2-M3-PI
		For 3/2-way solenoid valve	2 valves	197222	MHA1-PR2-3-M3-PI
			4 valves	197223	MHA1-PR4-3-M3-PI
			6 valves	197224	MHA1-PR6-3-M3-PI
			8 valves	197225	MHA1-PR8-3-M3-PI
			10 valves	197226	MHA1-PR10-3-M3-PI
	With plug bases and electrical multi-pin plug	For 3/2-way solenoid valve	4 valves	197238	MHA1-PR4-3-M3-PI-D9
			6 valves	197239	MHA1-PR6-3-M3-PI-D9
			8 valves	197240	MHA1-PR8-3-M3-PI-D9
			10 valves	197241	MHA1-PR10-3-M3-PI-D25
	Without plug bases, for mounting on a circuit board	For 3/2-way solenoid valve	2 valves	197247	MHA1-PR2-3-M3-PI-PCB
			4 valves	197248	MHA1-PR4-3-M3-PI-PCB
			6 valves	197249	MHA1-PR6-3-M3-PI-PCB
			8 valves	197250	MHA1-PR8-3-M3-PI-PCB
			10 valves	197251	MHA1-PR10-3-M3-PI-PCB
	Without plug bases, for circuit board mounting, with pneumatic multiple connector plate	For 3/2-way solenoid valve	4 valves	197253	MHA1-PR4-3-PI-PCBM
			6 valves	197254	MHA1-PR6-3-PI-PCBM
			8 valves	197255	MHA1-PR8-3-PI-PCBM
			10 valves	197256	MHA1-PR10-3-PI-PCBM



 **Note**
 Manifold rails with an uneven number of valves and for 11 ... 24 valves as well as further variants can be configured and ordered online via the modular product system for MH1.

 **Note**
 Valves types 3/2G and 3/2O must not be mixed on one manifold rail.

Datasheet

Ordering data				Pack size	Part no.	Type
Cover plate for manifold rail						
	For manifold rail for valves with plug connection at the rear or on top			–	197257	MHAP1-BP-3
	For manifold rail with plug bases for valves with plug connection underneath			–	197258	MHAP1-BP-3-PI
Blanking plug						
	For M3 thread		10	30979	B-M3-S9	
	For M5 thread		10	3843	B-M5	
	For M7 thread		10	174309	B-M7	
Silencer						
	M3 connecting thread		20	1231120	AMTE-M-LH-M3	
	M5 connecting thread	Polymer design	1	165003	UC-M5	
		Metal design	20	1205858	AMTE-M-LH-M5	
	M7 connecting thread		1	161418	UC-M7	
Push-in fittings						
	M3 connecting thread	With internal hex	For tubing O.D. 3 mm	10	153312	QSM-M3-3-I
			For tubing O.D. 4 mm	10	153314	QSM-M3-4-I
		With external hex	For tubing O.D. 3 mm	10	153301	QSM-M3-3
			For tubing O.D. 4 mm	10	153303	QSM-M3-4
	M5 connecting thread	With internal hex	For tubing O.D. 3 mm	10	153313	QSM-M5-3-I
			For tubing O.D. 4 mm	10	153315	QSM-M5-4-I
			For tubing O.D. 6 mm	10	153317	QSM-M5-6-I
		With external hex	For tubing O.D. 3 mm	10	153302	QSM-M5-3
			For tubing O.D. 4 mm	10	153304	QSM-M5-4
			For tubing O.D. 6 mm	10	153306	QSM-M5-6
	M7 connecting thread	With internal hex	For tubing O.D. 4 mm	10	153319	QSM-M7-4-I
			For tubing O.D. 6 mm	10	153321	QSM-M7-6-I

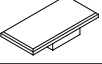
Datasheet

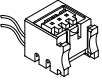
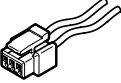
Ordering data				Pack size	Part no.	Type
Inscription label						
	For identifying the valve positions			–	197259	MH-BZ-80X
Soldering base						
	For manifold rail for valves with plug connection underneath for mounting on a circuit board, 3-pin		10		197261	PCBC-A-10
			100		197262	PCBC-A-100
Electrical plug base						
	For manifold rail, for valves with Plug connection underneath	2x stranded conductors Open end 1-core	0.5 m	–	197260	MHAP-PI
			1 m	–	532182	MHAP-PI-1
Plug socket with cable						
	Straight socket Plug pattern H 3-pin	2x stranded conductors Open end 1-core	0.5 m	–	566654	NEBV-H1G2-KN-0.5-N-LE2
			1 m	–	566655	NEBV-H1G2-KN-1-N-LE2
			2.5 m	–	566656	NEBV-H1G2-KN-2.5-N-LE2
			5 m	–	566657	NEBV-H1G2-KN-5-N-LE2

Datasheet

Function

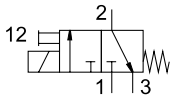

Voltage

5 V DC

12 V DC

24 V DC



Pressure

+1.5 ... +8 bar

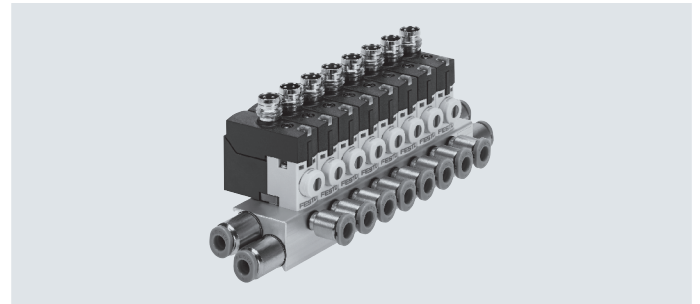

General technical data

Valve function	3/2-way solenoid valve	
	Normally closed	
	Single solenoid	
Design	Poppet valve with spring return	
Overlap	Negative overlap	
Sealing principle	Soft	
Actuation type	Electrical	
Reset method	Mechanical spring	
Type of actuation	Direct	
Flow direction	Not reversible	
Exhaust function	Can be throttled	
Manual override	Non-detenting/detenting	
Type of mounting	On sub-base via through-hole	
Mounting position	Any	
Nominal width	[mm]	0.65
Standard nominal flow rate	[l/min]	10
Width	[mm]	10
Grid dimension	[mm]	10
Pneumatic port	1	Sub-base
	2	Sub-base
	3	Sub-base
Product weight	[g]	10

Operating and environmental conditions

Type	MHA1-M4R...	MHA1-M5R...	MHA1-M1R...
Operating medium	Compressed air to ISO 8573-1:2010 [7:4:4]		
Note on the operating/pilot medium	Lubricated operation possible (in which case lubricated operation will always be required)		
Operating pressure	[MPa]	0.15 ... 0.8 ¹⁾	
	[bar]	1.5 ... 8 ¹⁾	
	[psi]	21.75 ... 116 ¹⁾	
Ambient temperature	[°C]	-5 ... +40	-5 ... +50
Temperature of medium	[°C]	-5 ... +50	-5 ... +50
Restricted ambient temperature and temperature of medium	[°C]	-	-5 ... +40
		-	Without holding current reduction
Storage temperature	[°C]	-20 ... +60	-20 ... +60
Corrosion resistance class CRC ²⁾	2	2	2
Certification	c UL us - Recognized (OL)		
Certificate-issuing authority	UL MH19482		

1) Vacuum operation possible with special connection method → page 3

2) More information www.festo.com/x/topic/crc

Datasheet

Safety characteristics				
Operating voltage		5 V DC	12 V DC	24 V DC
Note on forced checking procedure		Switching frequency min. 1/week		
Max. positive test pulse with logic 0	[μs]	–	–	500
Max. negative test pulse with logic 1	[μs]	–	–	400
Shock resistance		Shock test with severity level 2 in accordance with FN 942017-5 and EN 60068-2-27		
Vibration resistant		Transport application test with severity level 2 to FN 942017-4 and EN 60068-2-6		

Electrical data				
Type		MHA1-M4R...	MHA1-M5R...	MHA1-M1R...
Operating voltage	[V DC]	5	12	24
Permissible voltage fluctuations	[%]	±10	±10	±10
Electrical connection		Via E-box	Via E-box	Via E-box
Electrical power consumption	[W]	1	1	1
Duty cycle	[%]	100	100	100
Degree of protection		IP40	IP40	IP40
		IP65	IP65	IP65

Switching times and frequencies					
Type		MHA1-M4R...	MHA1-M5R...	MHA1-M1R...	
Switching time	On	[ms]	5	5	5
	Off	[ms]	5	5	5
Maximum switching frequency		[Hz]	10	10	10

Materials	
Housing	Reinforced PA, reinforced PPS
Seals	FPM, HNBR, NBR
Note on materials	RoHS-compliant
LABS (PWIS) conformity	VDMA24364-B2-L

Dimensions

Valve

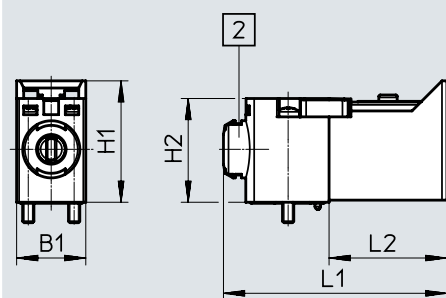

[2] Manual override

Hole pattern on sub-bases

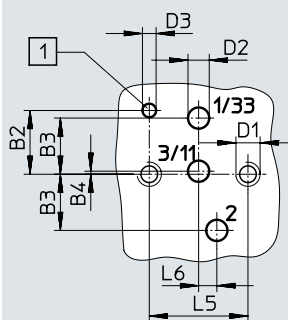

Download CAD data → www.festo.com

[1] Hole for coding pin

- If used as a 2/2-way valve, normally closed, ports 3/11 are not used.
- If used as a 2/2-way valve, normally open, ports 1/33 are not used.

Type	B1	B2	B3	B4	D1	D2	D3	H1	H2	L1	L2	L5	L6
MHA1	9.8	4.2	3.7	0.2	M1.6	1.4	0.9	17.2	14.7	31.7	16.7	6.5	1.2

Datasheet

Dimensions – Assembly on individual sub-base

Download CAD data → www.festo.com

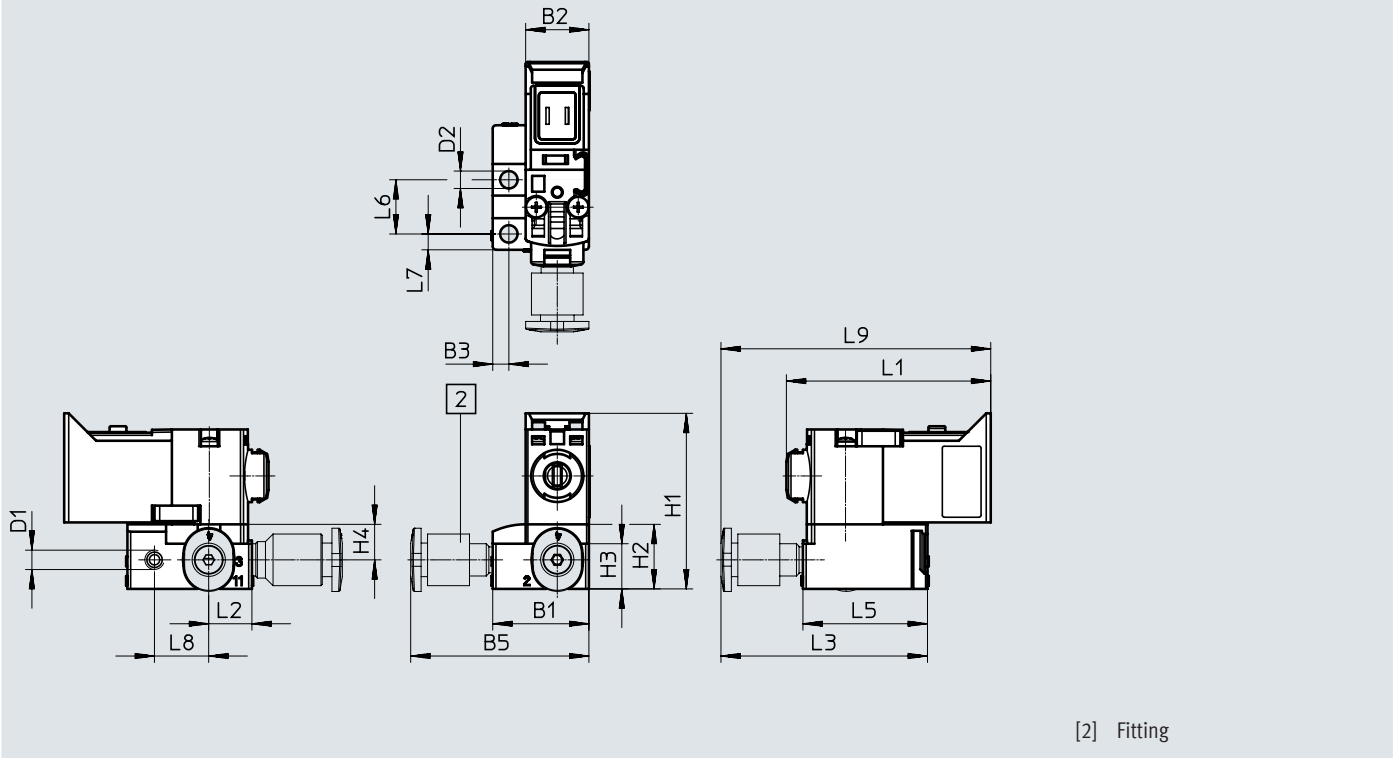

Type	B1	B2	B3	B5	D1	D2	H1	H2	H3	H4	L1	L2	L3	L5	L6	L7	L8	L9
3/2-way valve	14.9	9.8	2.5	27.6	M3	2.7	27.2	10	7	5.5	31.7	6.7	32	19.3	8.4	2.5	8.4	42

Datasheet

Dimensions – Manifold assembly

Download CAD data → www.festo.com

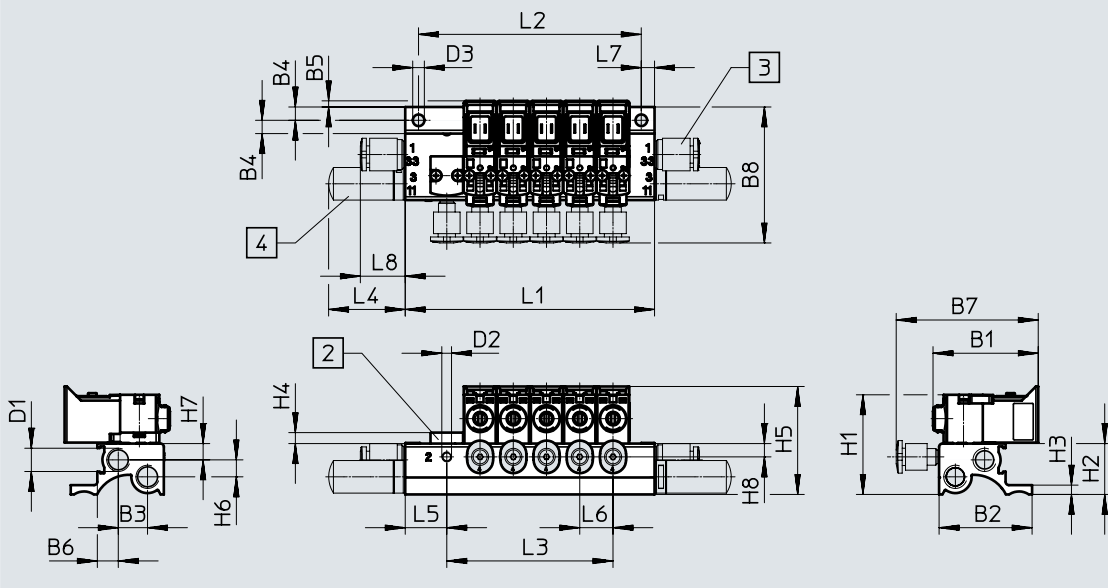

[2] Cover plate MHAP1

[3] Fitting

[4] Silencer

Type	B1	B2	B3	B4	B5	B6	B7	B8	D1	D2	D3
3/2-way valve	31.7	28	8.8	4	1.9	6.3	42.7	42	M7	M3	3.5



Type	H1	H2	H3	H4	H5	H6	H7	H8	L4	L5	L6	L7	L8
3/2-way valve	30	15.3	2.8	3.3	32.5	5.1	4.9	4	23.1	12.5	10	4	13.5

Valve positions n	L1	L2	L3
	±0.15	±0.1	
2	35	27	10
3	45	37	20
4	55	47	30
5	65	57	40
6	75	67	50
7	85	77	60
8	95	87	70

Valve positions n	L1	L2	L3
	±0.15	±0.1	
9	105	97	80
10	115	107	90
11	125	117	100
12	135	127	110
13	145	137	120
14	155	147	130
15	165	157	140

Valve positions n	L1	L2	L3
	±0.15	±0.1	
16	175	167	150
17	185	177	160
18	195	187	170
19	205	197	180
20	215	207	190
21	225	217	200
22	235	227	210

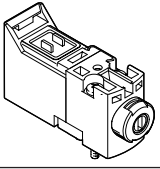

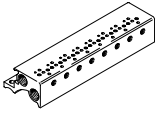



Datasheet

Ordering data		Valve function	Normal position		Part no.	Type
Solenoid valve						
	Without plug connection	3/2-way solenoid valve	Closed	5 V DC	8025224	MHA1-M4R-3/2G-0.6-P3
				12 V DC	8025225	MHA1-M5R-3/2G-0.6-P3
				24 V DC	8025223	MHA1-M1R-3/2G-0.6-P3
Individual sub-base						
	Individual sub-base Pneumatic connection: M3 thread		1 valve position		197183	MHA1-AS-3-M3
Manifold rail						
	Manifold rail Pneumatic connection: M3, M7 thread		2 valve positions		197202	MHA1-PR2-3-M3
			4 valve positions		197203	MHA1-PR4-3-M3
			6 valve positions		197204	MHA1-PR6-3-M3
			8 valve positions		197205	MHA1-PR8-3-M3
			10 valve positions		197206	MHA1-PR10-3-M3







**Note**

Manifold rails with an uneven number of valves and for 11 ... 24 valves as well as further variants can be configured and ordered online via the modular product system for MH1.



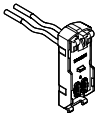

Datasheet

Ordering data				Pack size	Part no.	Type
Cover plate for manifold rail						
	Vacant valve positions must be sealed with a cover plate			–	197257	MHAP1-BP-3
Cover cap for manual override						
	Function covered The cover cap protects the manual override being accidentally actuated.			–	540898	VMPA-HBV-B
	Function non-detenting The cover cap prevents the manual override from latching.			–	540897	VMPA-HBT-B
	Function detenting The cover cap enables the manual override to be actuated and latched without tools.			–	8002234	VAMC-L1-CD
Blanking plug						
	For M3 thread			10	30979	B-M3-S9
	For M7 thread			10	174309	B-M7
Silencer						
	M3 connecting thread			20	1231120	AMTE-M-LH-M3
	M7 connecting thread			1	161418	UC-M7
Push-in fittings						
	M3 connecting thread	With internal hex	For tubing O.D. 3 mm	10	153312	QSM-M3-3-I
			For tubing O.D. 4 mm	10	153314	QSM-M3-4-I
		With external hex	For tubing O.D. 3 mm	10	153301	QSM-M3-3
			For tubing O.D. 4 mm	10	153303	QSM-M3-4
	M7 connecting thread	With internal hex	For tubing O.D. 4 mm	10	153319	QSM-M7-4-I
			For tubing O.D. 6 mm	10	153321	QSM-M7-6-I

Datasheet

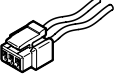
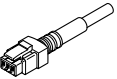
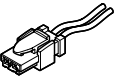
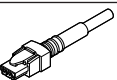
Ordering data											
Design	Electrical connection	Contacts	Cable length [m]	Nominal operating voltage [V DC]	Holding current reduction	Part no.	Type				
E-box base with protective circuit											
	Plug pattern H, angled	2-pin	–	12/24	–	566714	VAVE-L1-1VH2-LP				
				24	■	566716	VAVE-L1-1H2-LR				
	Plug pattern H, straight	2-pin	–	12/24	–	566715	VAVE-L1-1VH3-LP				
				24	■	566717	VAVE-L1-1H3-LR				
	Plug pattern S, angled	2-pin	–	12/24	–	566718	VAVE-L1-1VS2-LP				
				24	■	566720	VAVE-L1-1S2-LR				
	Plug pattern S, straight	2-pin	–	12/24	–	566719	VAVE-L1-1VS3-LP				
				24	■	566721	VAVE-L1-1S3-LR				
	Plug M8x1, angled	4-pin	–	12/24	–	573921	VAVE-L1-1VR1-LP				
				24	■	573922	VAVE-L1-1R1-LR				
		3-pin	–	12/24	–	573919	VAVE-L1-1VR8-LP				
				24	■	573920	VAVE-L1-1R8-LR				
	2x stranded conductors, open end	1-core	0.5	12/24	–	566722	VAVE-L1-1VL1-LP				
				24	■	566726	VAVE-L1-1L1-LR				
				1	–	12/24	–	566723	VAVE-L1-1VL2-LP		
						24	■	566727	VAVE-L1-1L2-LR		
				2.5	–	12/24	–	566724	VAVE-L1-1VL3-LP		
						24	■	566728	VAVE-L1-1L3-LR		
				5	–	12/24	–	566725	VAVE-L1-1VL4-LP		
						24	■	566729	VAVE-L1-1L4-LR		
					Cable, open end	2-core	0.5	12/24	–	573941	VAVE-L1-1VK6-LP
								24	■	573945	VAVE-L1-1K6-LR
1	–	12/24	–					573942	VAVE-L1-1VK7-LP		
		24	■					573946	VAVE-L1-1K7-LR		
2.5	–	12/24	–					573943	VAVE-L1-1VK8-LP		
		24	■					573947	VAVE-L1-1K8-LR		
5	–	12/24	–					573944	VAVE-L1-1VK9-LP		
		24	■					573948	VAVE-L1-1K9-LR		

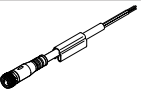

Datasheet

Ordering data					
	Electrical connection 1	Electrical connection 2	Length	Part no.	Type
Plug socket with cable for plug pattern H					Datasheets → Internet: nebv
	Straight socket Plug pattern H 3-pin	2x stranded conductors Open end 1-core	0.5 m	566654	NEBV-H1G2-KN-0.5-N-LE2
			1 m	566655	NEBV-H1G2-KN-1-N-LE2
			2.5 m	566656	NEBV-H1G2-KN-2.5-N-LE2
			5 m	566657	NEBV-H1G2-KN-5-N-LE2
	Straight socket Plug pattern H 3-pin	Cable Open end 2-core	0.5 m	566658	NEBV-H1G2-P-0.5-N-LE2
			1 m	566659	NEBV-H1G2-P-1-N-LE2
			2.5 m	566660	NEBV-H1G2-P-2.5-N-LE2
			5 m	566661	NEBV-H1G2-P-5-N-LE2
Plug socket with cable for plug pattern S					Datasheets → Internet: nebv
	Straight socket Plug pattern S 2-pin	2x stranded conductors Open end 1-core	0.5 m	566662	NEBV-HSG2-KN-0.5-N-LE2
			1 m	566663	NEBV-HSG2-KN-1-N-LE2
			2.5 m	566664	NEBV-HSG2-KN-2.5-N-LE2
			5 m	566665	NEBV-HSG2-KN-5-N-LE2
	Straight socket Plug pattern S 2-pin	Cable Open end 2-core	0.5 m	566666	NEBV-HSG2-P-0.5-N-LE2
			1 m	566667	NEBV-HSG2-P-1-N-LE2
			2.5 m	566668	NEBV-HSG2-P-2.5-N-LE2
			5 m	566669	NEBV-HSG2-P-5-LE2
Connecting cable for plug M8x1					Datasheets → Internet: nebu
4-pin					Datasheets → Internet: nebu
	Straight socket Plug coding type A, to EN 61076-2-104	Cable Open end 4-core	2.5 m	541342	NEBU-M8G4-K-2.5-LE4
			5 m	541343	NEBU-M8G4-K-5-LE4
	Angled socket Plug coding type A, to EN 61076-2-104	Cable Open end 4-core	2.5 m	541344	NEBU-M8W4-K-2.5-LE4
			5 m	541345	NEBU-M8W4-K-5-LE4
3-pin					Datasheets → Internet: nebu
	Straight socket Plug coding type A, to EN 61076-2-104	Cable Open end 3-core	2.5 m	541333	NEBU-M8G3-K-2.5-LE3
			5 m	541334	NEBU-M8G3-K-5-LE3
	Angled socket Plug coding type A, to EN 61076-2-104	Cable Open end 3-core	2.5 m	541338	NEBU-M8W3-K-2.5-LE3
			5 m	541341	NEBU-M8W3-K-5-LE3

Datasheet

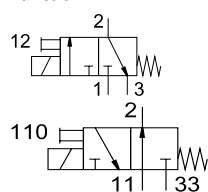
Function



-  - Voltage
24 V DC
-  - Pressure
0 ... +8 bar
-  - Temperature range
-5 ... +50°C

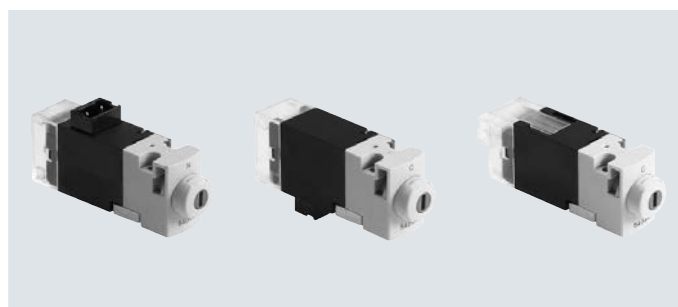

General technical data			
Type		MHA1-M1LH-...-3/2G-...	MHA1-M1LH-...-3/2O-...
Valve function		3/2-way solenoid valve	3/2-way solenoid valve
		Normally closed	Normally open
		Single solenoid	Single solenoid
Design		Poppet valve with spring return	
Overlap		Negative overlap	
Sealing principle		Soft	
Actuation type		Electrical	
Reset method		Mechanical spring	
Type of actuation		Direct	
Flow direction		Not reversible	
Exhaust function		Can be throttled	
Manual override		Non-detenting/detenting	
Signal status indication		LED	
Type of mounting		On sub-base via through-hole	
Mounting position		Any	
Valve position identification		Label	
Nominal width	[mm]	0.65	0.7
Standard nominal flow rate	[l/min]	10	10
Width	[mm]	10	10
Grid dimension	[mm]	10	10
Pneumatic port	1	Sub-base	-
	2	Sub-base	Sub-base
	3	Sub-base	-
	11	-	Sub-base
	33	-	Sub-base
Product weight	[g]	11	11

Operating and environmental conditions			
Type		MHA1-M1LH-...-3/2G-...	MHA1-M1LH-...-3/2O-...
Operating medium		Compressed air to ISO 8573-1:2010 [7:4:4]	
Note on the operating/pilot medium		Lubricated operation possible (in which case lubricated operation will always be required)	
Operating pressure	[MPa]	0 ... 0.8 ¹⁾	0 ... 0.6 ¹⁾
	[bar]	0 ... 8 ¹⁾	0 ... 6 ¹⁾
	[psi]	0 ... 116 ¹⁾	0 ... 87 ¹⁾
Ambient temperature	[°C]	-5 ... +40	
Temperature of medium	[°C]	-5 ... +40	
Storage temperature	[°C]	-20 ... +60	
Corrosion resistance class CRC ²⁾		2	
Certification		c UL us - Recognized (OL)	
Certificate-issuing authority		UL MH19482	

1) Vacuum operation possible with special connection method → page 3

2) More information www.festo.com/x/topic/crc

Datasheet

Safety characteristics	
Note on forced checking procedure	Switching frequency min. 1/week
Shock resistance	Shock test with severity level 2 in accordance with FN 942017-5 and EN 60068-2-27
Vibration resistant	Transport application test with severity level 2 to FN 942017-4 and EN 60068-2-6

Electrical data		
Operating voltage	[V DC]	24
Permissible voltage fluctuations	[%]	±10
Electrical connection		Plug
Electrical power consumption	[W]	1.1
Duty cycle	[%]	100
Degree of protection to EN 60529		IP40

Switching times and frequencies			
Switching time	On	[ms]	4
	Off	[ms]	4
Maximum switching frequency		[Hz]	20

Materials	
Housing	Reinforced PA, reinforced PPS
Sub-base	Aluminium
Seals	FPM, HNBR, NBR
Note on materials	RoHS-compliant
LABS (PWIS) conformity	VDMA24364-B2-L

Dimensions

Plug connection on top

[1] Plug socket NEBV-H1G2 [2] Manual override
[3] Coding pin

Plug connection at the rear

[1] Plug socket NEBV-H1G2

Plug connection underneath

Download CAD data → www.festo.com

Type	B1	H1	H2	H4	L1	L2	L3
MHA1	9.8	14.7	3.6	27.7	38.7	23.7	51.7

Datasheet

Dimensions – Hole pattern on sub-bases

Download CAD data → www.festo.com

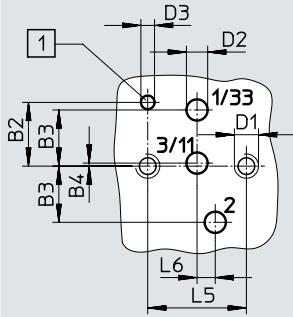

[1] Hole for coding pin

- If used as a 2/2-way valve, normally closed, ports 3/11 are not used.
- If used as a 2/2-way valve, normally open, ports 1/33 are not used.

Type	B2	B3	B4	D1	D2	D3	L5	L6
MHA1	4.2	3.7	0.2	M1.6	1.4	0.9	6.5	1.2

Dimensions – Assembly on individual sub-base

Download CAD data → www.festo.com

3/2-way valve

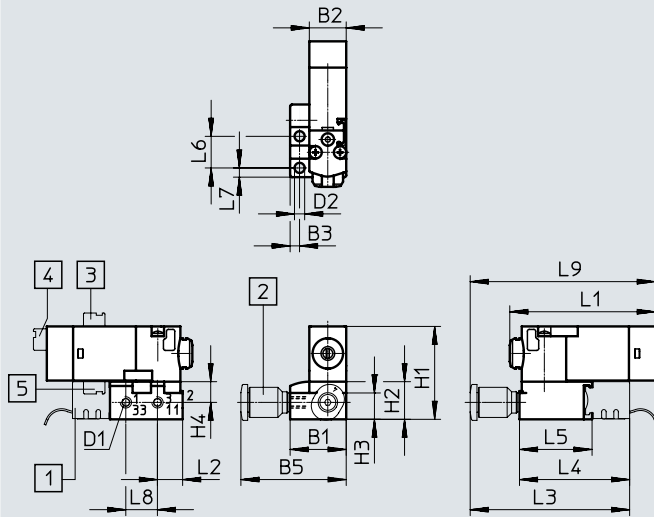

- [1] Plug base MHAP-PI
- [2] Fitting
- [3] Plug connection on top
- [4] Plug connection at the rear
- [5] Plug connection underneath

Type	B1	B2	B3	B5	D1	D2	H1	H2	H3	H4	L1	L2	L3	L4	L5	L6	L7	L8	L9
3/2-way valve	14.9	9.8	2.5	28	M3	2.7	24.7	10	7	5.5	38.7	6.7	43.1	29.1	19.3	8.4	2.5	8.4	50.1

Datasheet

Dimensions – Manifold assembly

Download CAD data → www.festo.com

3/2-way valve

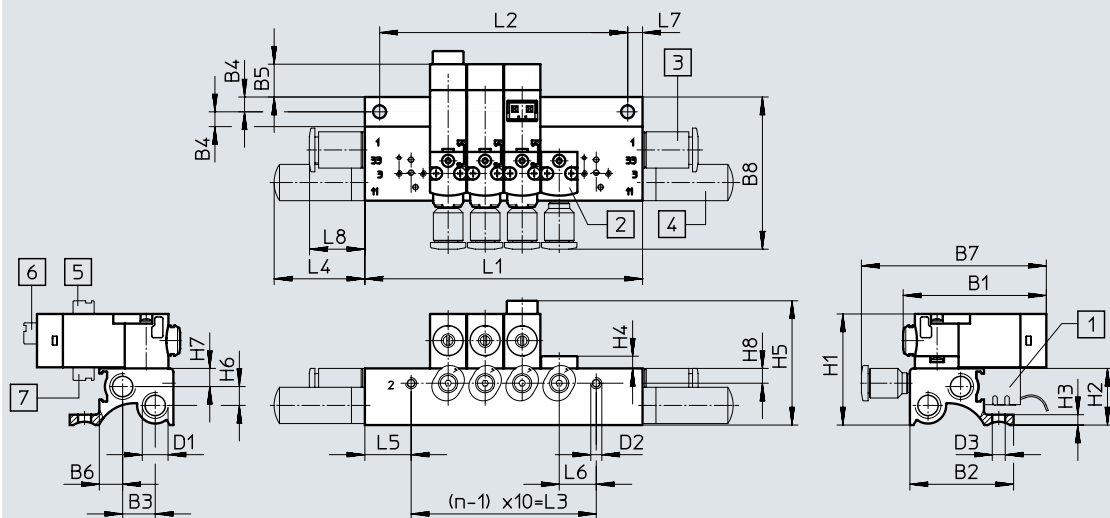

- [1] Plug base MHAP-PI
- [2] Cover plate MHAP1
- [3] Fitting
- [4] Silencer
- [5] Plug connection on top
- [6] Plug connection at the rear
- [7] Plug connection underneath

Type	B1	B2	B3	B4	B5	B6	B7	B8	D1	D2
3/2-way valve	38.7	28	8.8	4	8.9	6.3	50	42	M7	M3

Type	H1	H2	H3	H4	H5	H6	H7	H8	L4	L5	L6	L7	L8
3/2-way valve	30	15.3	2.8	3.3	33.6	5.1	4.9	4	23.1	12.5	10	4	13.5

Valve positions n	L1 ±0.15	L2 ±0.1	L3
2	35	27	10
3	45	37	20
4	55	47	30
5	65	57	40
6	75	67	50
7	85	77	60
8	95	87	70

Valve positions n	L1 ±0.15	L2 ±0.1	L3
9	105	97	80
10	115	107	90
11	125	117	100
12	135	127	110
13	145	137	120
14	155	147	130
15	165	157	140

Valve positions n	L1 ±0.15	L2 ±0.1	L3
16	175	167	150
17	185	177	160
18	195	187	170
19	205	197	180
20	215	207	190
21	225	217	200
22	235	227	210

Datasheet

Dimensions – Manifold assembly with electrical multi-pin plug

Download CAD data → www.festo.com

3/2-way valve

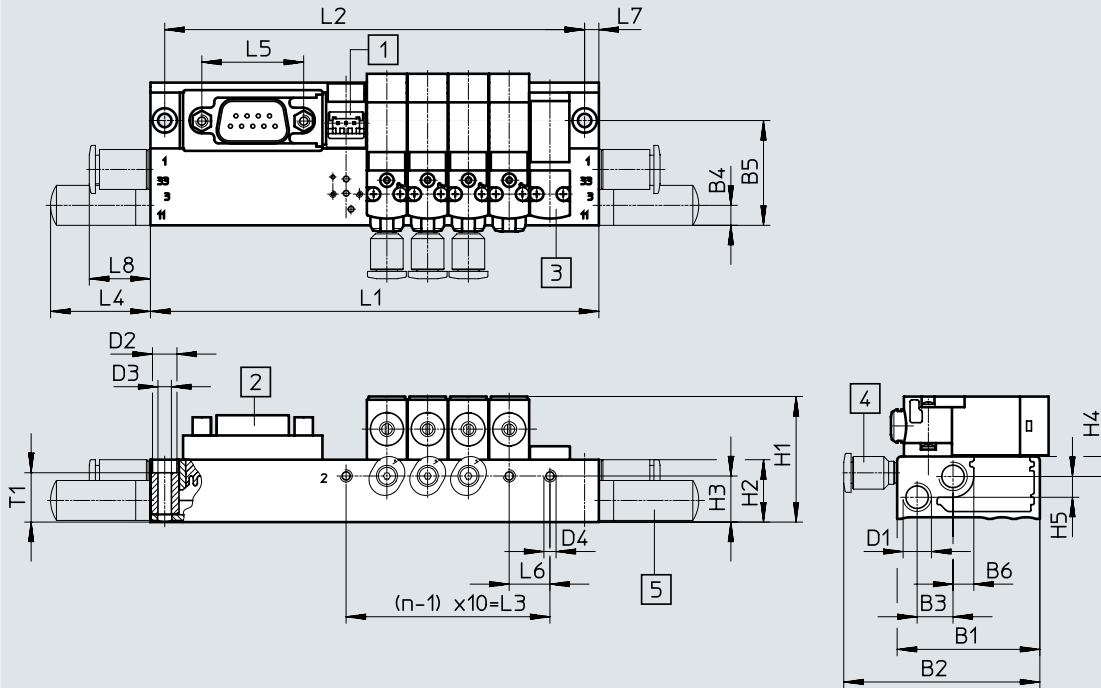

- [1] Plug base MHAP-PI [3] Cover plate MHAP1 [5] Silencer
- [2] Sub-D plug, plug outlet on top (standard) [4] Fitting

Type	B1	B2	B3	B4	B5	B6	D1	D2	D3	D4	H1	H2	H3	H4	H5	L4	L5	L6	L7	L8	T1
MHA1	35	48.1	8.8	5.3	25.7	5.2	M7	6	3.3	M3	30.8	15.3	11.3	4.9	5.1	24.5	25	10	3.5	15	12.1

Valve positions n	L1 ±0.15	L2 ±0.1	L3
2	70	63	10
4	90	83	30
6	110	103	50
8	130	123	70

Valve positions n	L1 ±0.15	L2 ±0.1	L3
10	172	165	90
12	192	185	110
14	212	205	130
16	232	225	150

Valve positions n	L1 ±0.15	L2 ±0.1	L3
18	252	245	170
20	272	265	190
22	292	285	210

Plug outlet to the pneumatic side

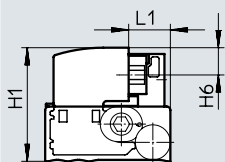

Plug outlet to the electrical side

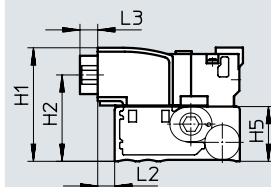

Plug outlet on top (standard)

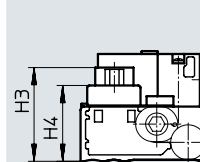

Type	H1	H2	H3	H4	H5	H6	L1	L2	L3
MHA1	31.8	24.2	26.2	21.2	15.3	7.6	11.7	4.8	5

Datasheet

Dimensions – Manifold assembly on a circuit board

Download CAD data → www.festo.com

3/2-way valve, without pneumatic multiple connector plate

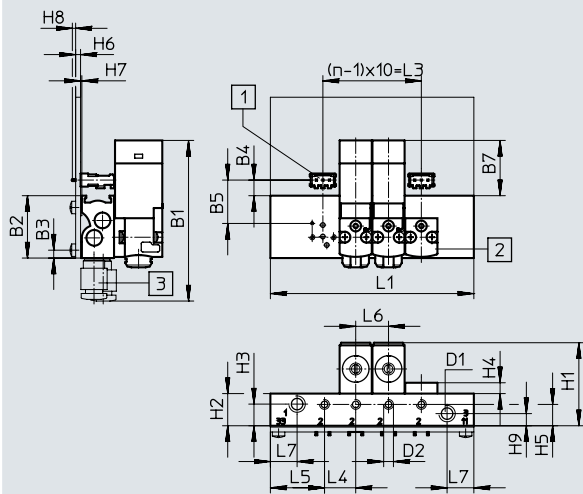

- [1] Soldering base PCBC-A
- [2] Cover plate MHAP1
- [3] Fitting

Note
The circuit board is not included in the scope of delivery.

Type	B1	B2	B3	B4	B5	B7	D1	D2
Without pneumatic multiple connector plate	49	19	2.4	4.8	13.2	16.9	M5	M3

Type	H1	H2	H3	H4	H5	H6	H7	H8	H9	L4	L5	L6	L7
Without pneumatic multiple connector plate	25.3	9.8	6.6	3.3	6.5	1.5	0.4	1	3.7	9.5	16.5	10	8.2

Valve positions n	L1 ±0.15	L3
2	42	10
4	62	30
6	82	50
8	102	70
10	122	90

Datasheet

Dimensions – Manifold assembly on a circuit board

Download CAD data → www.festo.com

3/2-way valve, with pneumatic multiple connector plate

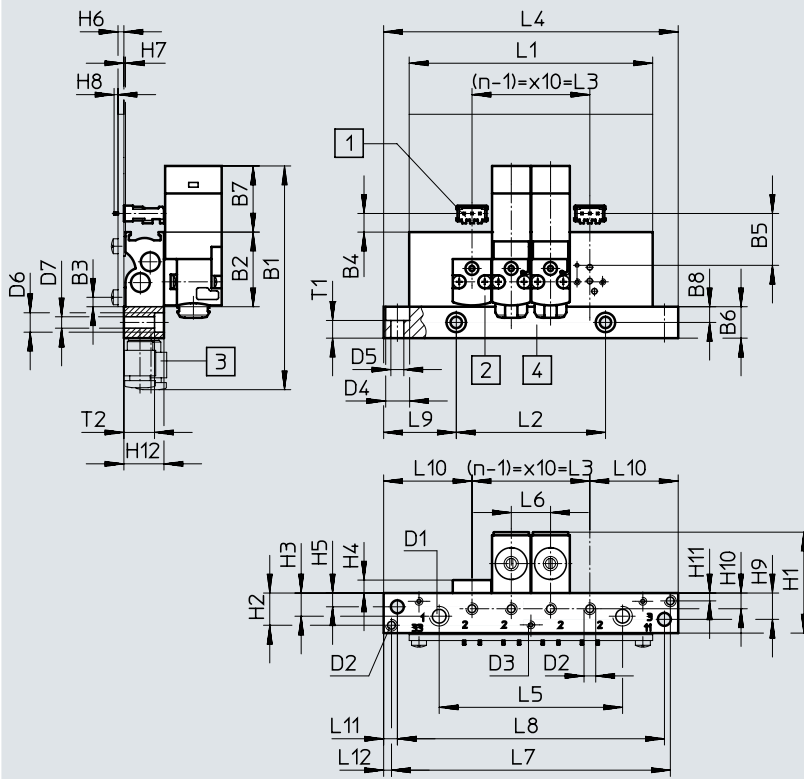

- [1] Soldering base PCBC-A
- [2] Cover plate MHAP1
- [3] Fitting
- [4] Pneumatic multiple connector plate, removable

 **Note**
The circuit board is not included in the scope of delivery.

Type	B1	B2	B3	B4	B5	B6	B7	B8	D1	D2	D3	D4	D5	D6	D7
With pneumatic multiple connector plate	56.5	19	2.4	4.8	13.2	8	16.9	4	M5	M3	M2	6.1	3.3	5	2.9

Type	H1	H2	H3	H4	H5	H6	H7	H8	H9	H10	H11	H12	L6	L9	L10	L11	L12	T1	T2
With pneumatic multiple connector plate	25.7	8.2	5.9	3.3	3.5	1.5	0.4	1	6.7	4	2	10.2	10	18.5	22.5	3.5	2	4.5	7.8

Valve positions n	L1 ±0.15	L2 ±0.1	L3	L4 ±0.2	L5 ±0.15	L7 ±0.1	L8
4	62	38	30	75	46.7	71	68
6	82	58	50	95	66.7	91	88
8	102	78	70	115	86.7	111	108
10	122	98	90	135	106.7	131	128

Datasheet

Dimensions – Manifold assembly on a circuit board

Download CAD data → www.festo.com

Hole pattern on circuit board

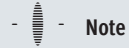
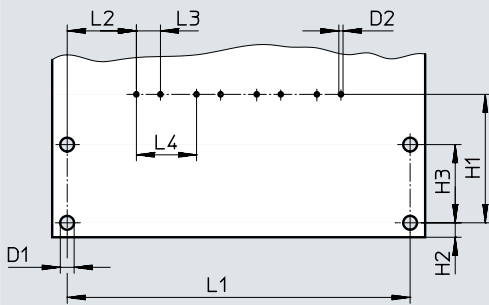

Note

The circuit board is not included in the scope of delivery.

Type	D1	D2	H1	H2	H3	L2	L3	L4
Circuit board	2.3	0.7	21.4	2.4	13	11.5	4	10

Valve positions n	L1
	±0.1
2	37
4	57
6	77
8	97
10	117

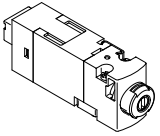
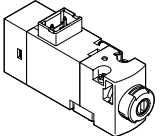
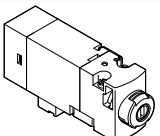

Datasheet

Ordering data		Valve function	Normal position		Part no.	Type
Solenoid valve						
	Plug connection at the rear	3/2-way solenoid valve	Closed	24 V DC	540443	MHA1-M1LH-3/2G-0.6-HC
			Open	24 V DC	540440	MHA1-M1LH-3/2O-0.6-HC
	Plug connection on top	3/2-way solenoid valve	Closed	24 V DC	540444	MHA1-M1LH-3/2G-0.6-TC
			Open	24 V DC	540441	MHA1-M1LH-3/2O-0.6-TC
	Plug connection underneath	3/2-way solenoid valve	Closed	24 V DC	540445	MHA1-M1LH-3/2G-0.6-PI
			Open	24 V DC	540442	MHA1-M1LH-3/2O-0.6-PI

 **Note**

Valves types 3/2G and 3/2O must not be mixed on one manifold rail.

Datasheet

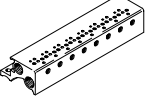
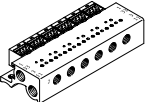
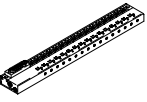
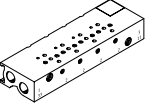
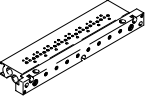
Ordering data				Part no.	Type
Individual sub-base					
	For valves with plug connection at the rear or on top	For 3/2-way solenoid valve	1 valve position	197183	MHA1-AS-3-M3
	For valves with plug connection underneath	For 3/2-way solenoid valve	1 valve position	197185	MHA1-AS-3-M3-PI
Manifold rail, for valves with plug connection at the rear or on top					
	Without plug bases	For 3/2-way solenoid valve	2 valves	197202	MHA1-PR2-3-M3
			4 valves	197203	MHA1-PR4-3-M3
			6 valves	197204	MHA1-PR6-3-M3
			8 valves	197205	MHA1-PR8-3-M3
			10 valves	197206	MHA1-PR10-3-M3
Manifold rail, for valves with plug connection underneath					
	With plug bases	For 3/2-way solenoid valve	2 valves	197222	MHA1-PR2-3-M3-PI
			4 valves	197223	MHA1-PR4-3-M3-PI
			6 valves	197224	MHA1-PR6-3-M3-PI
			8 valves	197225	MHA1-PR8-3-M3-PI
			10 valves	197226	MHA1-PR10-3-M3-PI
	With plug bases and electrical multi-pin plug	For 3/2-way solenoid valve	4 valves	197238	MHA1-PR4-3-M3-PI-D9
			6 valves	197239	MHA1-PR6-3-M3-PI-D9
			8 valves	197240	MHA1-PR8-3-M3-PI-D9
			10 valves	197241	MHA1-PR10-3-M3-PI-D25
	Without plug bases, for mounting on a circuit board	For 3/2-way solenoid valve	2 valves	197247	MHA1-PR2-3-M3-PI-PCB
			4 valves	197248	MHA1-PR4-3-M3-PI-PCB
			6 valves	197249	MHA1-PR6-3-M3-PI-PCB
			8 valves	197250	MHA1-PR8-3-M3-PI-PCB
			10 valves	197251	MHA1-PR10-3-M3-PI-PCB
	Without plug bases, for mounting on a circuit board, with pneumatic multiple connector plate	For 3/2-way solenoid valve	4 valves	197253	MHA1-PR4-3-PI-PCBM
			6 valves	197254	MHA1-PR6-3-PI-PCBM
			8 valves	197255	MHA1-PR8-3-PI-PCBM
			10 valves	197256	MHA1-PR10-3-PI-PCBM









 - **Note**

Manifold rails with an uneven number of valves and for 11 ... 24 valves as well as further variants can be configured and ordered online via the modular product system for MH1.



 - **Note**

Valves types 3/2G and 3/2O must not be mixed on one manifold rail.

Datasheet

Ordering data				Pack size	Part no.	Type
Cover plate for manifold rail						
	For manifold rail for valves with plug connection at the rear or on top			–	197257	MHAP1-BP-3
	For manifold rail with plug bases for valves with plug connection underneath				197258	MHAP1-BP-3-PI
Cover cap for manual override						
	Function covered The cover cap protects the manual override against accidental actuation			–	540898	VMPA-HBV-B
	Function non-detenting The cover cap prevents the manual override from latching.			–	540897	VMPA-HBT-B
	Function detenting The cover cap enables the manual override to be actuated and latched without tools.			–	8002234	VAMC-L1-CD
Blanking plug						
	For M3 thread			10	30979	B-M3-S9
	For M5 thread			10	3843	B-M5
	For M7 thread			10	174309	B-M7
Silencer						
	M3 connecting thread			20	1231120	AMTE-M-LH-M3
	M5 connecting thread	Polymer design		1	165003	UC-M5
		Metal design		20	1205858	AMTE-M-LH-M5
	M7 connecting thread			1	161418	UC-M7
Push-in fittings						
	M3 connecting thread	With internal hex	For tubing O.D. 3 mm	10	153312	QSM-M3-3-I
			For tubing O.D. 4 mm	10	153314	QSM-M3-4-I
		With external hex	For tubing O.D. 3 mm	10	153301	QSM-M3-3
			For tubing O.D. 4 mm	10	153303	QSM-M3-4
	M5 connecting thread	With internal hex	For tubing O.D. 3 mm	10	153313	QSM-M5-3-I
			For tubing O.D. 4 mm	10	153315	QSM-M5-4-I
			For tubing O.D. 6 mm	10	153317	QSM-M5-6-I
		With external hex	For tubing O.D. 3 mm	10	153302	QSM-M5-3
			For tubing O.D. 4 mm	10	153304	QSM-M5-4
			For tubing O.D. 6 mm	10	153306	QSM-M5-6
	M7 connecting thread	With internal hex	For tubing O.D. 4 mm	10	153319	QSM-M7-4-I
			For tubing O.D. 6 mm	10	153321	QSM-M7-6-I

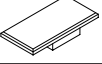
Datasheet

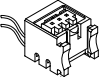
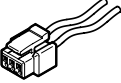
Ordering data				Pack size	Part no.	Type
Inscription label						
	For identifying the valve positions			–	197259	MH-BZ-80X
Soldering base						
	For manifold rail for valves with plug connection underneath for mounting on a circuit board, 3-pin		10		197261	PCBC-A-10
			100		197262	PCBC-A-100
Electrical plug base						
	For manifold rail, for valves with plug connection underneath	2x stranded conductors Open end 1-core	0.5 m	–	197260	MHAP-PI
			1 m	–	532182	MHAP-PI-1
Plug socket with cable						
	Straight socket Plug pattern H 3-pin	2x stranded conductors Open end 1-core	0.5 m	–	566654	NEBV-H1G2-KN-0.5-N-LE2
			1 m	–	566655	NEBV-H1G2-KN-1-N-LE2
			2.5 m	–	566656	NEBV-H1G2-KN-2.5-N-LE2
			5 m	–	566657	NEBV-H1G2-KN-5-N-LE2

Peripherals overview

2x2/2-way sub-base valve with LED

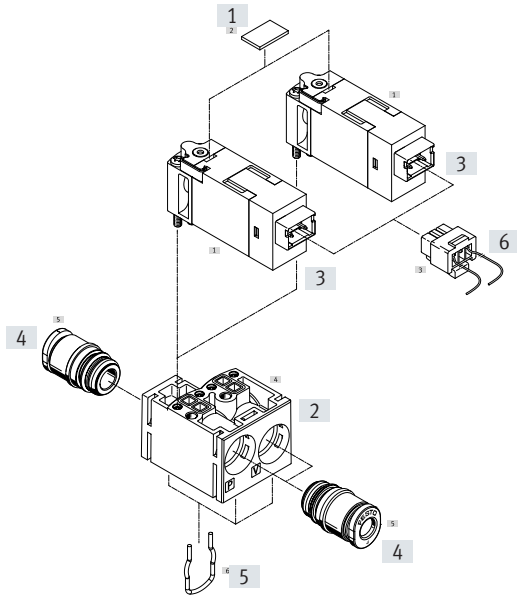



Designation	Description	→ Page/Internet
[1] Inscription label	For identifying the valve positions	58
[2] Sub-base	Included in the scope of delivery	–
[3] Solenoid valve	2/2-way valve, normally closed	58
[4] Push-in cartridge	Included in the scope of delivery	58
[5] Clip	Included in the scope of delivery	–
[6] Plug socket with cable	Straight socket, plug pattern H, 3-pin	58

Datasheet

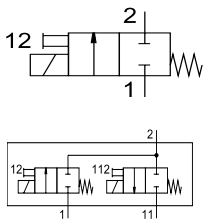
Function



-  Voltage
24 V DC
-  Pressure
- 0.95 ... +1.5 bar
-  Temperature range
-5 ... +50°C

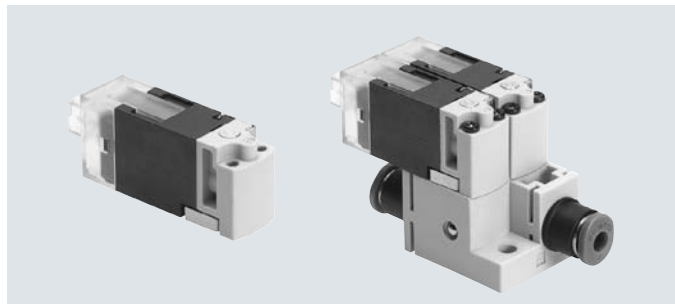

General technical data		2/2-way, single solenoid, closed	2x2/2-way, single solenoid, closed
Valve function		2/2-way, single solenoid, closed	2x2/2-way, single solenoid, closed
Design		Poppet valve with spring return	-
Sealing principle		Soft	
Actuation type		Electrical	
Reset method		Mechanical spring	
Type of actuation		Direct	
Flow direction		Not reversible	
Suitable for vacuum		Yes	
Exhaust function		Cannot be throttled	
Manual override		Non-detenting	
Signal status indication		LED	
Type of mounting		On sub-base	Via through-hole
Mounting position		Any	
Nominal width	[mm]	1.5	
Standard nominal flow rate	[l/min]	30	
Standard flow rate	[l/min]	30	
Width	[mm]	10	20
Grid dimension	[mm]	10	20
Pneumatic port			
	1	Sub-base	QS3, QS4, prepared for QSP10
	11	Sub-base	QS3, QS4, prepared for QSP10
	2	Sub-base	QS3, QS4, prepared for QSP10

Operating and environmental conditions		2/2-way, single solenoid, closed	2x2/2-way, single solenoid, closed
Valve function		2/2-way, single solenoid, closed	2x2/2-way, single solenoid, closed
Operating medium		Compressed air to ISO 8573-1:2010 [7:4:4]	
Note on the operating/pilot medium		Lubricated operation possible (in which case lubricated operation will always be required)	
Operating pressure	[bar]	0 ... 1.5	
Operating pressure, reversible	[bar]	- 0.95 ... 0	
Ambient temperature	[°C]	-5 ... +50	
Temperature of medium	[°C]	-5 ... +50	
Storage temperature	[°C]	-20 ... +60	
Corrosion resistance class CRC ¹⁾		2	
Certification		RCM	-
CE marking (see declaration of conformity)		To EU EMC Directive ²⁾ To EU RoHS Directive ²⁾	
UKCA marking (see declaration of conformity)		To UK EMC regulations ²⁾ To UK RoHS regulations ²⁾	

1) More information www.festo.com/x/topic/crc

2) For information about the area of use, see the EC declaration of conformity at: www.festo.com/catalogue/... → Support/Downloads.

If the devices are subject to usage restrictions in residential, commercial or light-industrial environments, further measures for the reduction of the emitted interference may be necessary.

Datasheet

Safety characteristics	
Shock resistance	Shock test with severity level 2 in accordance with FN 942017-5 and EN 60068-2-27
Vibration resistant	Transport application test with severity level 2 to FN 942017-4 and EN 60068-2-6

Electrical data		
Operating voltage	[V DC]	24
Permissible voltage fluctuations	[%]	±10
Electrical connection		Plug KMH
Power consumption	[W]	3, following current reduction 0.7
Duty cycle	[%]	100
Max. cable length	[m]	30
Degree of protection		IP40

Switching times and frequencies			
Switching time	On	[ms]	6
	Off	[ms]	6
Maximum switching frequency		[Hz]	10

Materials	
Housing	Reinforced PA, reinforced PPS
Screws	Steel
Seals	FPM, HNBR, NBR
Note on materials	RoHS-compliant
LABS (PWIS) conformity	VDMA24364-B2-L

Dimensions

2/2-way valve

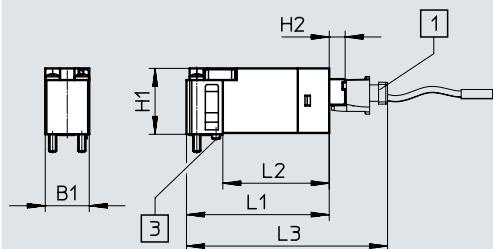

[1] Plug socket NEBV-H1G2

[3] Coding pin

Download CAD data → www.festo.com

2x2/2-way valve

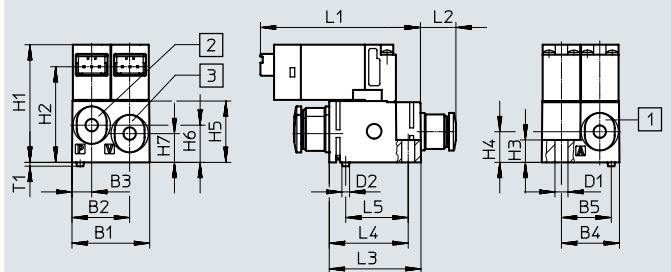

[1] Push-in connector 2



[2] Push-in connector 1

[3] Push-in connector 11

Type	B1	B2	B3	B4	B5	D1	D2	H1	H2	H3	H4	H5	H6	H7	L1	L2	L3	L4	L5	T1
2/2-way valve	9.8	–	–	–	–	–	–	14.7	3.6	–	–	–	–	–	31.8	23.7	44.8	–	–	–
2x2/2-way valve	20	14.9	5	15	13	3.4	2	30.7	26	5.9	8	16	9.7	7.5	41.8	9.2	23.8	20.6	16.3	1

1) Packaging unit.

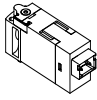
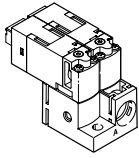
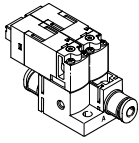
Datasheet

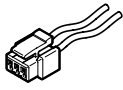
Ordering data				Weight [g]	Pneumatic port	Part no.	Type
2/2-way solenoid valve							
	Plug connection at the rear	10	Via sub-base			557864	MHA1-M1LCH-2/2G-1.5-HC
2x2/2-way solenoid valve on sub-base							
	Plug connection at the rear	26.3	Connection for 10 mm cartridge			563365	MHA1-2X2/2G-1.5
	Plug connection at the rear	30.6	Push-in connector for tubing O.D. 3 mm			562051	MHA1-2X2/2G-1.5-3-3-3
		30.6	Push-in connector for tubing O.D. 4 mm			566175	MHA1-2X2/2G-1.5-4-4-4
		30.6	Push-in connector for tubing O.D. 4 mm, port 2 with push-in connector for tubing O.D. 3 mm			560372	MHA1-2X2/2G-1.5-4-4-3
Ordering data				Pack size	Part no.	Type	
Push-in fittings							
	10 mm cartridge	Polymer	For tubing O.D. 3 mm	10	132621	QSPKG10-3	
			For tubing O.D. 4 mm	10	132622	QSPKG10-4	
			For tubing O.D. 6 mm	10	132623	QSPKG10-6	
Inscription label							
	For identifying the valve positions					197259	MH-BZ-80X
Plug socket with cable							
	Straight socket Plug pattern H 3-pin	2x stranded conductors Open end 1-core	0.5 m	–	566654	NEBV-H1G2-KN-0.5-N-LE2	
			1 m	–	566655	NEBV-H1G2-KN-1-N-LE2	
			2.5 m	–	566656	NEBV-H1G2-KN-2.5-N-LE2	
			5 m	–	566657	NEBV-H1G2-KN-5-N-LE2	

Festo - Your Partner in Automation



1 Festo Inc.
5300 Explorer Drive
Mississauga, ON L4W 5G4
Canada

Festo Customer Interaction Center
Tel: 1 877 463 3786
Fax: 1 877 393 3786
Email: customer.service.ca@festo.com



2 Festo Pneumatic
Av. Ceylán 3,
Col. Tequesquináhuac
54020 Tlalnepantla,
Estado de México

Multinational Contact Center
01 800 337 8669
ventas.mexico@festo.com



3 Festo Corporation
1377 Motor Parkway
Suite 310
Islandia, NY 11749

Festo Customer Interaction Center
1 800 993 3786
1 800 963 3786
customer.service.us@festo.com



4 Regional Service Center
7777 Columbia Road
Mason, OH 45040

Connect with us



www.festo.com/socialmedia



www.festo.com

Subject to change