

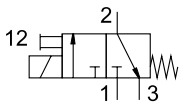

Datasheet



MCH-3-1/8

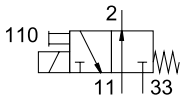

-  - Flow rate
70 l/min
160 l/min

MOCH-3-1/8



-  - Temperature range
-5 ... +40°C
-  - Pressure
0 ... 0.7 MPa

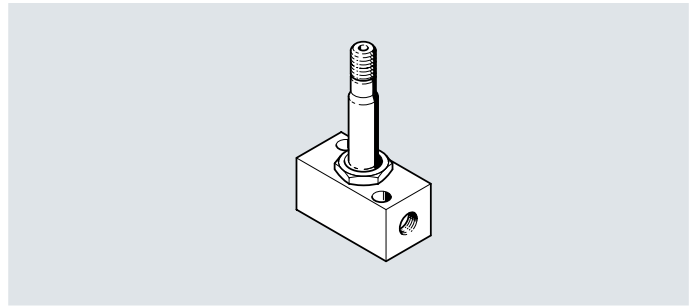

Operation with different pressures

Duty cycle

Up to an operating pressure of 5.5 MPa, 100% duty cycle is permissible; for the pressure range 0.55 ... 0.7 MPa the value is reduced to 40%.

General technical data	MOCH-3-1/8	MCH-3-1/8
Valve function	3/2, normally open, single solenoid	3/2, normally closed, single solenoid
Design	Poppet valve with spring return	
Sealing principle	Soft	
Reset method	Mechanical spring	
Actuation type	Electrical	
Type of control	Direct	
Direction of flow	Not reversible	
Manual override	Detenting	
Nominal width	[mm] 2.5	
Standard nominal flow rate	[l/min] 70	160
Type of mounting	Via through-hole	
Pneumatic connection	1	G1/8
	2	G1/8
	3	G1/8
Note on materials	RoHS-compliant	

Operating and environmental conditions

Operating medium	Compressed air to ISO 8573-1:2010 [7:4:4]	
Operating pressure	[MPa]	0 ... 0.7
	[bar]	0 ... 7
Ambient temperature	[°C]	-5 ... +40
Temperature of medium	[°C]	-10 ... +60
Storage temperature	[°C]	-40 ... +100

Datasheet

Electrical data											
Direct voltage	Operating voltage	[V DC]	12	24	42	96	110	220	240		
	Power consumption	[W]	11.7	11	12	11	12.7	15	17.9		
Alternating voltage	Operating voltage	[V AC]	12	24	42	48	110	120	220	240	380
		[Hz]	50	50	50/60	50	50/60	60	50/60	50	50/60
	Pick-up power	[VA]	30								
	Holding power	[VA]	22								
Duty cycle		[%]	100								
Degree of protection			IP65								

Switching times and frequencies			
Switching time	On	[ms]	12
	Off	[ms]	13

Dimensions Download CAD data → www.festo.com

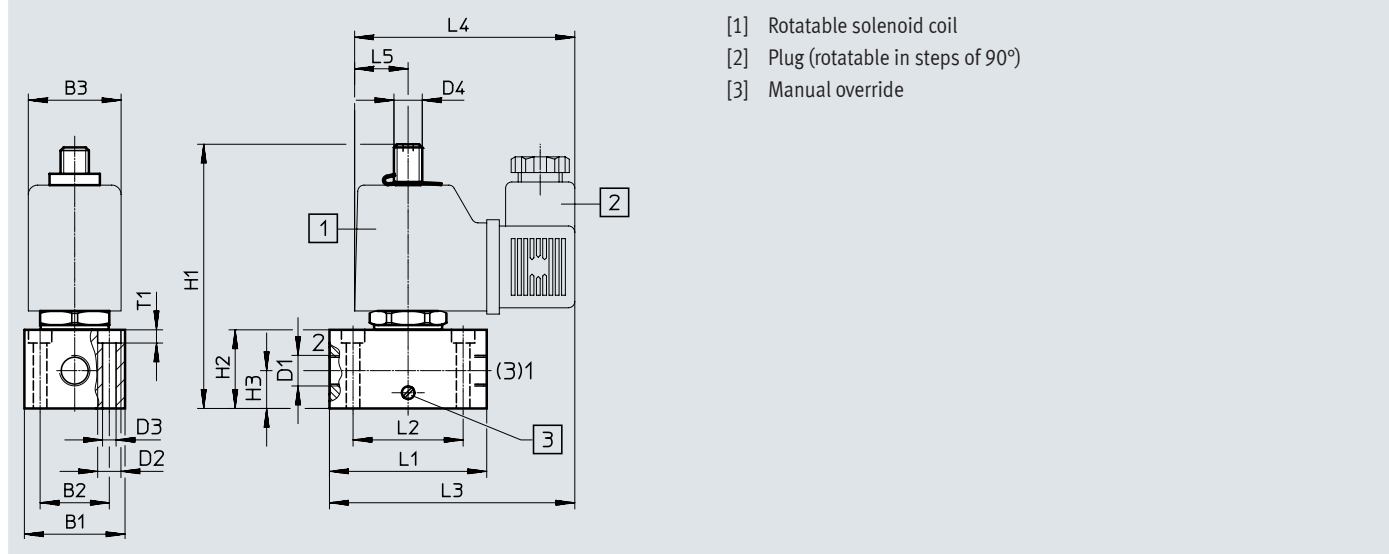

Type	B1	B2	B3	D1	D2 ∅	D3 ∅	D4	H1	H2	H3	L1	L2	L3	L4	L5	T1
MCH-3-1/8	32	22	29.5	G1/8	8	4.5	G1/8	83	25	12	50	35	78	70	17	4.7
MOCH-3-1/8	32	22	29.5	G1/8	8	4.5	G1/8	84	25	12	50	35	78	70	17	4.8

Ordering data		Part no.	Type
12		2199	MCH-3-1/8
110		2211	MOCH-3-1/8

Festo - Your Partner in Automation



1 Festo Inc.
5300 Explorer Drive
Mississauga, ON L4W 5G4
Canada

Festo Customer Interaction Center
Tel: 1 877 463 3786
Fax: 1 877 393 3786
Email: customer.service.ca@festo.com



2 Festo Pneumatic
Av. Ceylán 3,
Col. Tequesquináhuac
54020 Tlalneptla,
Estado de México

Multinational Contact Center
01 800 337 8669
ventas.mexico@festo.com



3 Festo Corporation
1377 Motor Parkway
Suite 310
Islandia, NY 11749

Festo Customer Interaction Center
1 800 993 3786
1 800 963 3786
customer.service.us@festo.com



4 Regional Service Center
7777 Columbia Road
Mason, OH 45040

Connect with us



www.festo.com/socialmedia



www.festo.com

Subject to change