

Angle grippers HGW

FESTO



Angle grippers HGW

Key features

FESTO



At a glance

- Double-acting piston drive
- Self-centring
- Variable gripping action:
 - External/internal gripping
- Versatility thanks to externally adaptable gripper fingers
- Wide range of options for mounting on drive units
- Constant gripping torque over the entire angle range
- 40° opening angle
- Internal fixed flow control
- Sensor technology:
 - Adaptable proximity sensors on the small grippers
 - Integral proximity sensors for medium and large grippers

-  - Note
Sizing software
Gripper selection
➔ www.festo.com

Mounting options for external gripper fingers (customer-specific)

- 1 Angle gripper
- 2 External gripper fingers
- 3 Mounting screws
- 4 Centring pins

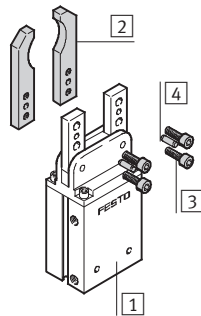

-  - Note
Grippers should always be used with exhaust air flow control. They are not suitable for the following, or for similar applications:

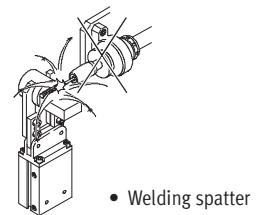
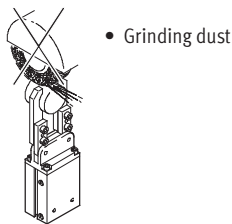
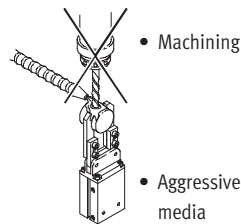

Angle grippers HGW

Peripherals overview and type codes

Peripherals overview

HGW-10

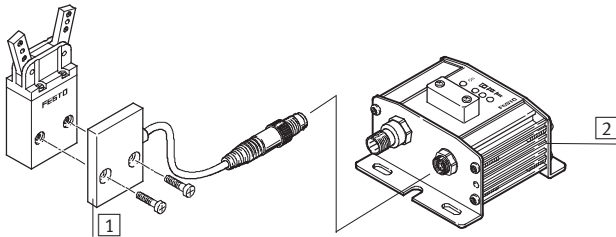

HGW-16 ... 40

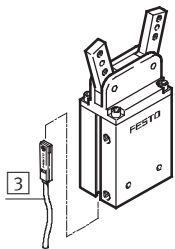

System product for handling and assembly technology

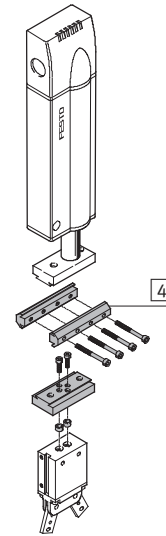

| Accessories | | | |
|-------------|----------------------------|---|-----------------|
| Type | | Brief description | → Page/Internet |
| 1 | Position sensor SMH-S1 | Adaptable and integratable sensor technology, for sensing the piston position | 11 |
| 2 | Evaluation unit SMH-AE1 | For position sensor SMH-S1 | 11 |
| 3 | Proximity sensor SME/SMT-8 | For sensing the piston position | 11 |
| 4 | - | Drive/gripper connections | adapter kit |

Type codes

| | | | | | |
|-------------------------|-----------------------|---|----|---|---|
| HGW | | - | 16 | - | A |
| Type | | | | | |
| HGW | Angle gripper | | | | |
| Size | | | | | |
| Position sensing | | | | | |
| A | For proximity sensing | | | | |

Angle grippers HGW

Technical data

FESTO

Function
Double-acting

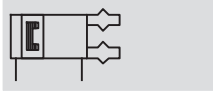

[www.festo.com/en/
Spare_parts_service](http://www.festo.com/en/Spare_parts_service)

Wearing parts kits
→ 10



Size
10 ... 40 mm

| General technical data | | 10 | 16 | 25 | 32 | 40 |
|-----------------------------------|------|--------------------------------------|----|----|-----------------|----|
| Design | | Lever mechanism | | | | |
| Mode of operation | | Double-acting | | | | |
| Gripper function | | Angle | | | | |
| Number of gripper jaws | | 2 | | | | |
| Opening angle | [°] | 40 | | | | |
| Pneumatic connection | | M3 | | M5 | G $\frac{1}{8}$ | |
| Repetition accuracy ¹⁾ | [mm] | ≤ 0.04 | | | | |
| Max. interchangeability | [mm] | 0.2 | | | | |
| Max. operating frequency | [Hz] | 4 | | | | |
| Position sensing | | For proximity sensing | | | | |
| Type of mounting | | With female thread and centring hole | | | | |

1) End position drift under constant conditions of use with 100 consecutive strokes in the direction of movement of the gripper jaws

| Operating and environmental conditions | | |
|--|-------|---|
| Min. operating pressure | [bar] | 2 |
| Max. operating pressure | [bar] | 8 |
| Operating medium | | Filtered compressed air, lubricated or unlubricated |
| Ambient temperature | [°C] | +5 ... +60 |
| Corrosion resistance class CRC ¹⁾ | | 2 |

1) Corrosion resistance class 2 according to Festo standard 940 070
Components requiring moderate corrosion resistance. Externally visible parts with primarily decorative surface requirements which are in direct contact with a normal industrial environment or media such as coolants or lubricating agents

| Weights [g] | | 10 | 16 | 25 | 32 | 40 |
|-------------|--|----|-----|-----|-----|-----|
| HGW | | 39 | 100 | 250 | 420 | 720 |

Angle grippers HGW

Technical data

Materials

Sectional view

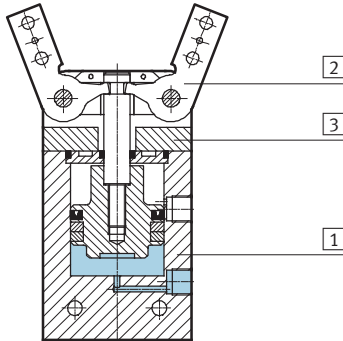

| Angle gripper | | |
|---------------|-------------------|--|
| 1 | Body | Hard anodised aluminium |
| 2 | Gripper jaw | Nickel-plated tool steel |
| 3 | Cover cap | Polyacetate |
| - | Note on materials | Copper, PTFE and silicone-free Conforms to RoHS |

Total gripping torque [Ncm] at 6 bar, with external gripper fingers

External gripping

Internal gripping

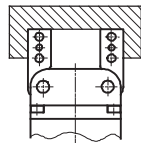
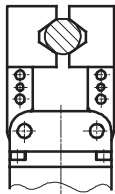

| Size | 10 | 16 | 25 | 32 | 40 |
|-----------------------|----|-----|-----|-----|-----|
| Total gripping torque | | | | | |
| Opening | 25 | 120 | 360 | 680 | 965 |
| Closing | 22 | 106 | 320 | 600 | 880 |

Characteristic load values at the gripper jaws

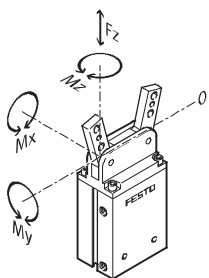

The indicated permissible forces and torques apply to a single gripper jaw. Static forces and torques relate to additional applied loads caused by

the workpiece or external gripper fingers, as well as forces which occur during handling. The zero co-ordinate

line (gripper jaws point of rotation) must be taken into consideration for the calculation of torques.

| Size | 10 | 16 | 25 | 32 | 40 | |
|-------------------------------|------|-----|-----|-----|-----|-----|
| Max. permissible force F_z | [N] | 16 | 31 | 54 | 74 | 124 |
| Max. permissible torque M_x | [Nm] | 0.3 | 0.9 | 1.7 | 3 | 5.7 |
| Max. permissible torque M_y | [Nm] | 0.1 | 0.3 | 0.6 | 1 | 2.2 |
| Max. permissible torque M_z | [Nm] | 0.2 | 0.5 | 1.1 | 1.8 | 3.6 |

Angle grippers HGW

Technical data

FESTO

Mass moment of inertia [$\text{kgm}^2 \times 10^{-4}$]

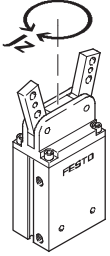

Mass moment of inertia [$\text{kgm}^2 \times 10^{-4}$] for angle grippers in relation to the central axis, without external gripper fingers, without load.

| Size | 10 | 16 | 25 | 32 | 40 |
|------|------|------|------|------|------|
| HGW | 0.03 | 0.13 | 0.60 | 1.48 | 3.54 |

Opening and closing times [ms] at 6 bar

Without external gripper fingers

With external gripper fingers

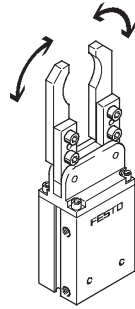
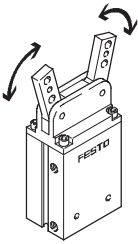

The indicated opening and closing times [ms] have been measured at room temperature and 6 bar operating pressure without external gripper fingers.

The grippers must be throttled for greater applied loads. Opening and closing times must then be adjusted accordingly.

| Size | 10 | 16 | 25 | 32 | 40 | |
|-----------------------------------|---------|----|----|----|----|----|
| Without external gripper fingers | | | | | | |
| HGW | Opening | 5 | 25 | 50 | 50 | 60 |
| | Closing | 5 | 30 | 40 | 40 | 50 |
| With external gripper fingers → 7 | | | | | | |

Angle grippers HGW

Technical data

Opening and closing times t as a function of gripper finger mass moment of inertia J

HGW-10-A

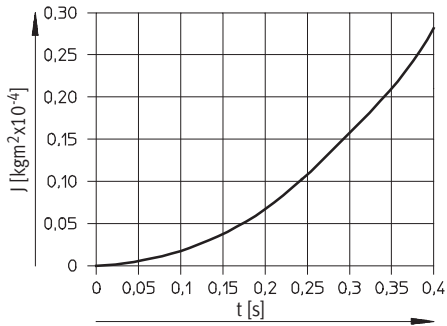

HGW-16-A

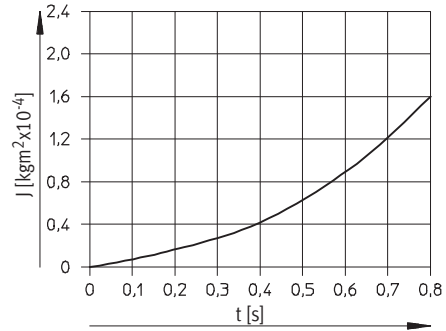

HGW-25-A

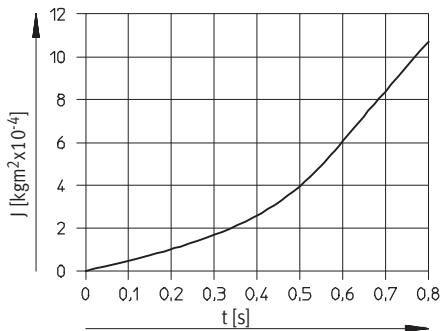

HGW-32-A

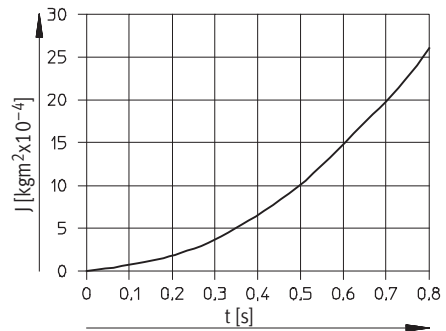

HGW-40-A

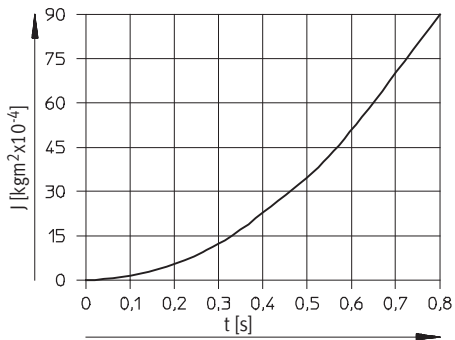

Angle grippers HGW

Technical data

FESTO

Gripping force F per gripper as a function of operating pressure and the lever arm r

Gripping forces

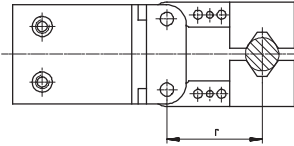

Gripping forces can be determined with the following diagrams for the various sizes in relation to operating

pressure and lever arm (distance from the zero co-ordinate line shown oppo-

site to the pressure point at which the external fingers grip the workpiece).

External gripping (closing)

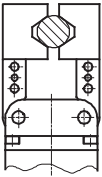

Internal gripping (opening)

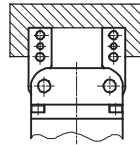

HGW-10-A

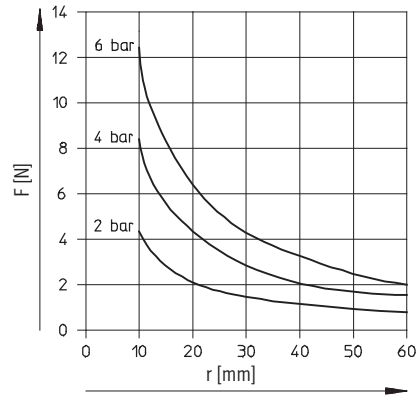
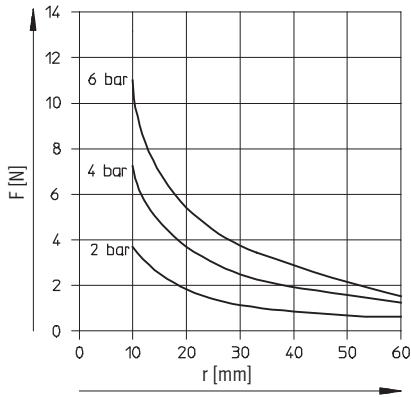

HGW-16-A

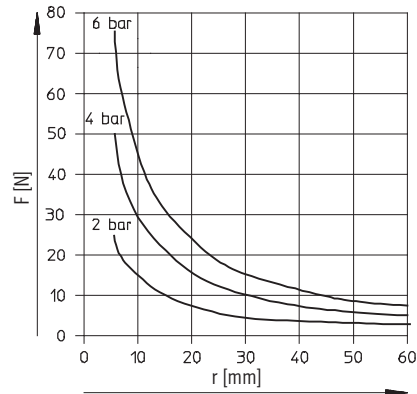
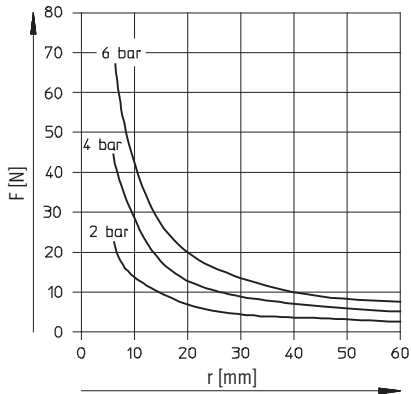

Angle grippers HGW

Technical data

Gripping force F per gripper as a function of operating pressure and the lever arm r

External gripping (closing)

Internal gripping (opening)

HGW-25-A

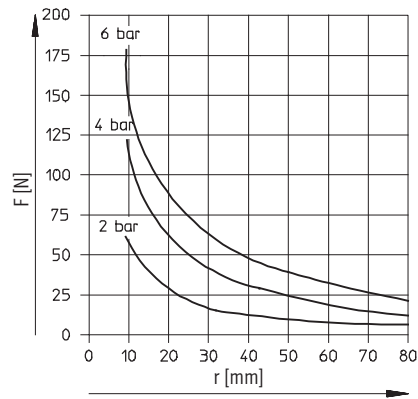
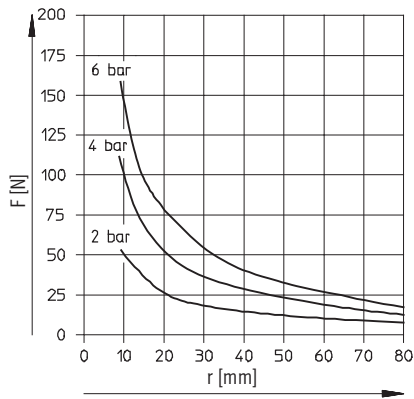

HGW-32A

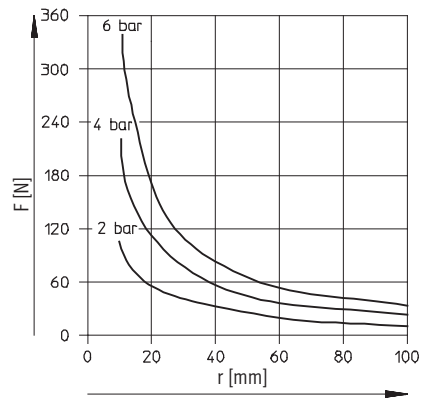
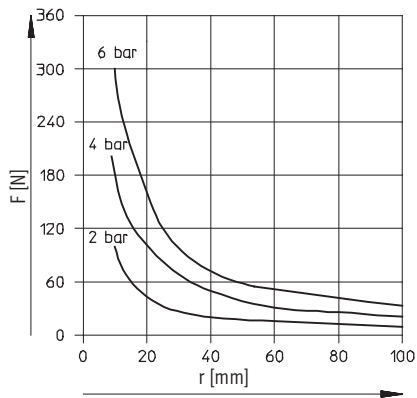

HGW-40A

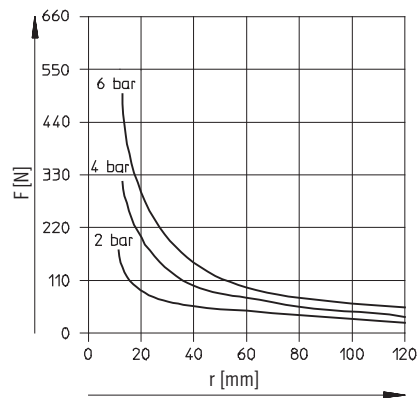
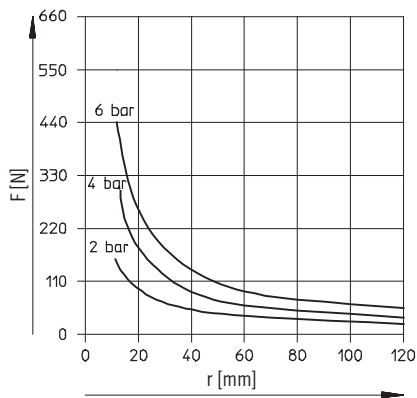

Angle grippers HGW

Technical data

FESTO

Dimensions

Download CAD data → www.festo.com/en/engineering

View A
HGW-10
HGW-16 ... 40

1 Sensor slot for proximity sensor SME/SMT-8 (not with HGW-10-A)
2 Compressed air connection, closing
3 Compressed air connection, opening
4 Centring sleeves ZBH (2 included in scope of delivery)

| Size | B1 | B2 | B3 | B4 | B5 | D2 | D3 | D4 | D5 | D6 | EE | H1 | H2 | H3 | H4 | H5 |
|------|------|-------|-------|------|-------------|----|------------|-----------|---------|-----|-----------------|------|------|------|-------|----|
| [mm] | | ±0.02 | ±0.02 | | -0.02/-0.05 | | ∅ H8/h7 | ∅ +0.1 | ∅ H8 | ∅ | | | | | | |
| 10 | 24 | 15 | 17 | 9.75 | 5.5 | M3 | 5 | 2.5 | 2 | 2.2 | M3 | 56.3 | 34.5 | 16 | 8.8 | 7 |
| 16 | 33.4 | 16 | 24 | 13 | 8 | M3 | 5 | 2.5 | 2.5 | 3.2 | M3 | 81 | 53.2 | 23 | 12.25 | 9 |
| 25 | 44 | 25 | 32 | 18 | 10 | M4 | 7 | 3.3 | 3 | 3.2 | M5 | 100 | 63.5 | 24.7 | 14.3 | 11 |
| 32 | 51 | 29 | 37 | 20.5 | 12 | M6 | 9 | 5.1 | 3 | 4.3 | G $\frac{1}{8}$ | 116 | 73 | 25 | 20 | 13 |
| 40 | 59 | 33 | 42 | 23.5 | 15 | M8 | 12 | 6.4 | 4 | 5.3 | G $\frac{1}{8}$ | 129 | 79.5 | 47 | 8 | 14 |

| Size | H6 | H7 | H8 | H9 | H10 | H11 | L1 | L2 | L3 | L4 | L6 | T1 | T2 | T3 | T4 | T5 |
|------|-----|------|-------|------|------|-------|------|------|-------|----|-------|------|------|----|------|-----|
| [mm] | | | ±0.05 | | | -0.05 | | | -0.02 | | ±0.02 | +0.1 | | +1 | +0.5 | |
| 10 | 3.5 | 5.75 | 10.75 | 44.8 | 27.5 | 12.3 | 14 | 2 | 3 | 7 | 2 | 1.2 | 12.3 | - | 3.5 | 1.2 |
| 16 | 4.5 | 7.5 | 13.7 | 65.5 | 52.3 | 7.5 | 19 | 5.5 | 4 | 10 | - | 1.2 | 7 | 7 | 4.5 | 1.2 |
| 25 | 5.5 | 8.8 | 18.7 | 80.7 | 65 | 7.5 | 29.5 | 8.75 | 5 | 14 | - | 1.6 | 7 | 8 | 6.5 | 1.4 |
| 32 | 6.5 | 11 | 22 | 92.5 | 72 | 11 | 38 | 9.5 | 6 | 17 | - | 2.1 | 10 | 15 | 6.5 | 1.9 |
| 40 | 7 | 12 | 25.5 | 103 | 74 | 17.5 | 49 | 11 | 8 | 21 | - | 2.6 | 15 | 16 | 6.5 | 2.4 |



| Ordering data | | |
|---------------|---------------|----------|
| Size | Double-acting | |
| [mm] | Part No. | Type |
| 10 | 174 818 | HGW-10-A |
| 16 | 161 833 | HGW-16-A |
| 25 | 161 834 | HGW-25-A |
| 32 | 161 835 | HGW-32-A |
| 40 | 161 836 | HGW-40-A |

| Ordering data – Wearing parts kits | | |
|------------------------------------|----------|----------|
| Size | | |
| [mm] | Part No. | Type |
| 10 | 378 527 | HGW-10-A |
| 16 | 125 680 | HGW-16-A |
| 25 | 125 681 | HGW-25-A |
| 32 | 125 682 | HGW-32-A |
| 40 | 125 683 | HGW-40-A |

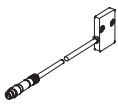

Angle grippers HGW

Accessories

FESTO

| Ordering data | | | | | |
|---|----------|------------|-----------------------------------|-----------------|------------------|
| Type | For size | Weight [g] | Part No. | Type | PU ¹⁾ |
| Position sensor SMH-S1 | | | Technical data → Internet: smh-s1 | | |
|  | 10 | 20 | 175 711 | SMH-S1-HGW10 | 1 |
| Evaluation unit SMH-AE1 | | | Technical data → Internet: smh-ae | | |
|  | 10 | 170 | 175 708 | SMH-AE1-PS3-M12 | 1 |
| | | | 175 709 | SMH-AE1-NS3-M12 | |
| Centring sleeve ZBH | | | Technical data → Internet: zbh | | |
|  | 10, 16 | 1 | 189 652 | ZBH-5 | 10 |
| | 25 | | 186 717 | ZBH-7 | |
| | 32 | | 150 927 | ZBH-9 | |
| | 40 | | 189 653 | ZBH-12 | |

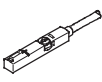

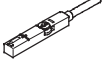
1) Packaging unit quantity



| Ordering data – Proximity sensors for T-slot, magneto-resistive | | | | | |
|---|--|-----------------------|-------------------|----------|---------------------------------|
| Type of mounting | Switch output | Electrical connection | Cable length [m] | Part No. | Type |
| N/O contact | | | | | |
|  | Insertable in the slot from above, flush with cylinder profile | PNP | Cable, 3-wire | 2.5 | 543 867 SMT-8M-PS-24V-K-2,5-OE |
| | | | Plug M8x1, 3-pin | 0.3 | 543 866 SMT-8M-PS-24V-K-0,3-M8D |
| | | | Plug M12x1, 3-pin | 0.3 | 543 869 SMT-8M-PS-24V-K-0,3-M12 |
|  | Insertable in the slot lengthwise, flush with the cylinder profile | NPN | Cable, 3-wire | 2.5 | 543 870 SMT-8M-NS-24V-K-2,5-OE |
| | | | Plug M8x1, 3-pin | 0.3 | 543 871 SMT-8M-NS-24V-K-0,3-M8D |
|  | Insertable in the slot lengthwise, flush with the cylinder profile | PNP | Cable, 3-wire | 2.5 | 175 436 SMT-8-PS-K-LED-24-B |
| | | | Plug M8x1, 3-pin | 0.3 | 175 484 SMT-8-PS-S-LED-24-B |
| N/C contact | | | | | |
|  | Insertable in the slot from above, flush with cylinder profile | PNP | Cable, 3-wire | 7.5 | 543 873 SMT-8M-PO-24V-K7,5-OE |

Angle grippers HGW

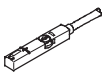
Accessories

FESTO

| Ordering data – Proximity sensors for T-slot, magnetic reed | | | | | Technical data → Internet: sme | |
|---|--|---------------|-----------------------|------------------|--------------------------------|--------------------------------|
| | Type of mounting | Switch output | Electrical connection | Cable length [m] | Part No. | Type |
| N/O contact | | | | | | |
|  | Insertable in the slot from above, flush with cylinder profile | Contacting | Cable, 3-wire | 2.5 | 543 862 | SME-8M-DS-24V-K-2,5-OE |
| | | | | 5.0 | 543 863 | SME-8M-DS-24V-K-5,0-OE |
| | | | Cable, 3-wire | 2.5 | 543 872 | SME-8M-ZS-24V-K-2,5-OE |
| | | | Plug M8x1, 3-pin | 0.3 | 543 861 | SME-8M-DS-24V-K-0,3-M8D |
|  | Insertable in the slot lengthwise, flush with the cylinder profile | Contacting | Cable, 3-wire | 2.5 | 150 855 | SME-8-K-LED-24 |
| | | | Plug M8x1, 3-pin | 0.3 | 150 857 | SME-8-S-LED-24 |
| N/C contact | | | | | | |
|  | Insertable in the slot lengthwise, flush with the cylinder profile | Contacting | Cable, 3-wire | 7.5 | 160 251 | SME-8-O-K-LED-24 |

| Ordering data – Connecting cables | | | | Technical data → Internet: nebu | |
|---|-------------------------------|------------------------------|------------------|---------------------------------|-----------------------------|
| | Electrical connection, left | Electrical connection, right | Cable length [m] | Part No. | Type |
|  | Straight socket, M8x1, 3-pin | Cable, open end, 3-wire | 2.5 | 541 333 | NEBU-M8G3-K-2.5-LE3 |
| | | | 5 | 541 334 | NEBU-M8G3-K-5-LE3 |
| | Straight socket, M12x1, 5-pin | Cable, open end, 3-wire | 2.5 | 541 363 | NEBU-M12G5-K-2.5-LE3 |
| | | | 5 | 541 364 | NEBU-M12G5-K-5-LE3 |
|  | Angled socket, M8x1, 3-pin | Cable, open end, 3-wire | 2.5 | 541 338 | NEBU-M8W3-K-2.5-LE3 |
| | | | 5 | 541 341 | NEBU-M8W3-K-5-LE3 |
| | Angled socket, M12x1, 5-pin | Cable, open end, 3-wire | 2.5 | 541 367 | NEBU-M12W5-K-2.5-LE3 |
| | | | 5 | 541 370 | NEBU-M12W5-K-5-LE3 |

Product Range and Company Overview

A Complete Suite of Automation Services

Our experienced engineers provide complete support at every stage of your development process, including: conceptualization, analysis, engineering, design, assembly, documentation, validation, and production.



Custom Automation Components
Complete custom engineered solutions



Custom Control Cabinets
Comprehensive engineering support and on-site services



Complete Systems
Shipment, stocking and storage services

The Broadest Range of Automation Components

With a comprehensive line of more than 30,000 automation components, Festo is capable of solving the most complex automation requirements.



Electromechanical
Electromechanical actuators, motors, controllers & drives



Pneumatics
Pneumatic linear and rotary actuators, valves, and air supply



PLCs and I/O Devices
PLC's, operator interfaces, sensors and I/O devices

Supporting Advanced Automation... As No One Else Can!

Festo is a leading global manufacturer of pneumatic and electromechanical systems, components and controls for industrial automation, with more than 12,000 employees in 56 national headquarters serving more than 180 countries. For more than 80 years, Festo has continuously elevated the state of manufacturing with innovations and optimized motion control solutions that deliver higher performing, more profitable automated manufacturing and processing equipment. Our dedication to the advancement of automation extends beyond technology to the education and development of current and future automation and robotics designers with simulation tools, teaching programs, and on-site services.

Quality Assurance, ISO 9001 and ISO 14001 Certifications

Festo Corporation is committed to supply all Festo products and services that will meet or exceed our customers' requirements in product quality, delivery, customer service and satisfaction.

To meet this commitment, we strive to ensure a consistent, integrated, and systematic approach to management that will meet or exceed the requirements of the ISO 9001 standard for Quality Management and the ISO 14001 standard for Environmental Management.



© Copyright 2008, Festo Corporation. While every effort is made to ensure that all dimensions and specifications are correct, Festo cannot guarantee that publications are completely free of any error, in particular typing or printing errors. Accordingly, Festo cannot be held responsible for the same. For Liability and Warranty conditions, refer to our "Terms and Conditions of Sale", available from your local Festo office. All rights reserved. No part of this publication may be reproduced, distributed, or transmitted in any form or by any means, electronic, mechanical, photocopying or otherwise, without the prior written permission of Festo. All technical data subject to change according to technical update.



Printed on recycled paper at New Horizon Graphic, Inc., FSC certified as an environmentally friendly printing plant.

Festo North America

Festo Regional Contact Center

5300 Explorer Drive
Mississauga, Ontario L4W 5G4
Canada

USA Customers:

For ordering assistance,

Call: 1.800.99.FESTO (1.800.993.3786)

Fax: 1.800.96.FESTO (1.800.963.3786)

Email: customer.service@us.festo.com

For technical support,

Call: 1.866.GO.FESTO (1.866.463.3786)

Fax: 1.800.96.FESTO (1.800.963.3786)

Email: product.support@us.festo.com

Canadian Customers:

Call: 1.877.GO.FESTO (1.877.463.3786)

Fax: 1.877.FX.FESTO (1.877.393.3786)

Email: festo.canada@ca.festo.com

USA Headquarters

Festo Corporation
395 Moreland Road
P.O. Box 18023
Hauppauge, NY 11788, USA
www.festo.com/us

USA Sales Offices

Appleton

North 922 Tower View Drive, Suite N
Greenville, WI 54942, USA

Boston

120 Presidential Way, Suite 330
Woburn, MA 01801, USA

Chicago

1441 East Business Center Drive
Mt. Prospect, IL 60056, USA

Dallas

1825 Lakeway Drive, Suite 600
Lewisville, TX 75057, USA

Detroit – Automotive Engineering Center

2601 Cambridge Court, Suite 320
Auburn Hills, MI 48326, USA

New York

395 Moreland Road
Hauppauge, NY 11788, USA

Silicon Valley

4935 Southfront Road, Suite F
Livermore, CA 94550, USA

United States



USA Headquarters, East: Festo Corp., 395 Moreland Road, Hauppauge, NY 11788

Phone: 1.631.435.0800; Fax: 1.631.435.8026;

Email: info@festo-usa.com

www.festo.com/us

Canada



Headquarters: Festo Inc., 5300 Explorer Drive, Mississauga, Ontario L4W 5G4

Phone: 1.905.624.9000; Fax: 1.905.624.9001;

Email: festo.canada@ca.festo.com

www.festo.ca

Mexico



Headquarters: Festo Pneumatic, S.A., Av. Ceylán 3, Col. Tequesquahuac,
54020 Tlalneantla, Edo. de México

Phone: 011 52 [55] 53 21 66 00; Fax: 011 52 [55] 53 21 66 65;

Email: festo.mexico@mx.festo.com

www.festo.com/mx

Central USA

Festo Corporation
1441 East Business
Center Drive
Mt. Prospect, IL 60056, USA
Phone: 1.847.759.2600
Fax: 1.847.768.9480



Western USA

Festo Corporation
4935 Southfront Road,
Suite F
Livermore, CA 94550, USA
Phone: 1.925.371.1099
Fax: 1.925.245.1286



Festo Worldwide

Argentina Australia Austria Belarus Belgium Brazil Bulgaria Canada Chile China Colombia Croatia Czech Republic Denmark
Estonia Finland France Germany Great Britain Greece Hong Kong Hungary India Indonesia Iran Ireland Israel Italy Japan Latvia
Lithuania Malaysia Mexico Netherlands New Zealand Norway Peru Philippines Poland Romania Russia Serbia Singapore
Slovakia Slovenia South Africa South Korea Spain Sweden Switzerland Taiwan Thailand Turkey Ukraine United States Venezuela

www.festo.com