

Parallel grippers HGP, with protective dust cap

FESTO



Key features

At a glance

- Double-acting piston drive
- With protective dust cap for use in dusty environments (degree of protection IP54)
- Self-centring
- Variable gripping action:
 - External/internal gripping
- High gripping force and compact size
- Max. repetition accuracy
- Internal fixed flow control
- Versatile thanks to externally adaptable gripper fingers
- Wide range of adaptation options on the drives
- Sensor technology:
 - Adaptable proximity switches for the small grippers
 - Integrated proximity switches for the medium and large gripper sizes

 **Note**
 Engineering software
 Gripper selection
 → www.festo.com

Mounting options for external gripper fingers (customer-specific)

- [1] Parallel gripper
- [2] External gripper fingers
- [3] Mounting screws
- [4] Centring pins

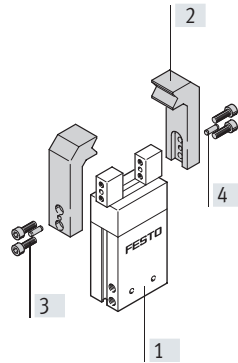

 **Note**
 These grippers should always be used with exhaust air flow control. They are not suitable for the following or similar applications:

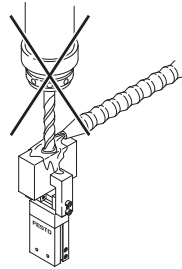

- Machining
- Aggressive media



- Grinding dust

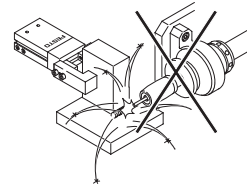

- Welding spatter

Peripherals overview and type codes

Peripherals overview

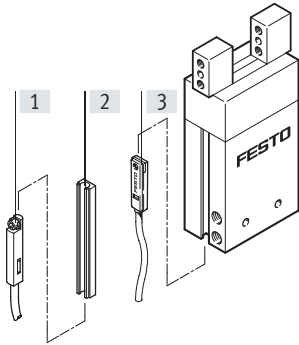

System product for handling and assembly technology

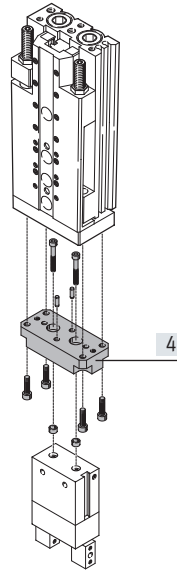

Accessories			
Type	Description		→ Page/Internet
[1] Proximity switch SME/SMT-10	For sensing the piston position		10
[2] Bondable sensor rail HGP-SL	Enables the use of proximity switches SME/SMT-10		9
[3] Proximity switch SME/SMT-8	For sensing the piston position		9
[4] –	Drive/gripper connections		adapter kit

Type codes

001	Series		
HGP	Parallel gripper		
002	Size		
16	16		
25	25		

003	Position sensing		
A	For proximity sensor		
004	Generation		
B	Series B		
005	Dust protection		
SSK	protective dust cap		

Data sheet

Function
Double-acting



www.festo.com

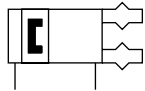

- - Size
16, 25 mm

- - Stroke
10, 14 mm



General technical data			
Size	16		25
Design	Lever		
Mode of operation	Double-acting		
Gripper function	Parallel		
Number of gripper jaws	2		
Max. mass per gripper finger ¹⁾	[g]	40	80
Stroke per gripper jaw	[mm]	5	7.5
Pneumatic connection	M3		G1/8
Repetition accuracy ²⁾	[mm]	≤ 0.04	
Max. interchangeability	[mm]	0.2	
Max. operating frequency	[Hz]	4	
Position sensing	Via proximity switch		
Type of mounting	Via female thread and centring sleeve Via through-hole and centring sleeve		
Mounting position	Any		
Product weight	[g]	197	737

1) Applies to unthrottled operation

2) Under constant exposure to operating conditions, end-position drift occurs in the direction of movement of the gripper jaws, at 100 consecutive strokes

- - Note: This product conforms to ISO 1179-1 and ISO 228-1.

Operating and environmental conditions			
Min. operating pressure	[bar]	2	
Max. operating pressure	[bar]	8	
Operating medium	Compressed air to ISO 8573-1:2010 [7:4:4]		
Note on the operating/pilot medium	Lubricated operation possible (in which case lubricated operation will always be required)		
Ambient temperature	[°C]	+5 ... +60	
Corrosion resistance class CRC ¹⁾	1		

1) Corrosion resistance class CRC 1 to Festo standard FN 940070

Low corrosion stress. Dry indoor application or transport and storage protection. Also applies to parts behind covers, in the non-visible interior area, and parts which are covered in the application (e.g. drive trunnions).

Data sheet

Materials

Sectional view

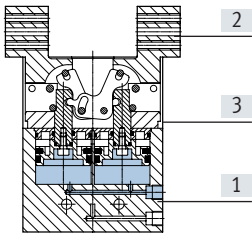

Cylinder with holding brake

[1] Housing	Hard-anodised aluminium
[2] Gripper jaw	High-alloy steel
[3] Cover cap	Polyamide
- Protective dust cap	Vulcanised thermoplastic
- Note on materials	Free of copper and PTFE
	RoHS-compliant

Gripping force [N] at 6 bar

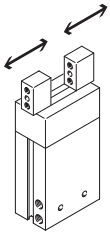

Size	16	25
Gripping force per gripper jaw		
Opening	70	185
Closing	80	170
Total gripping force		
Opening	140	370
Closing	160	340

Characteristic load values per gripper jaw

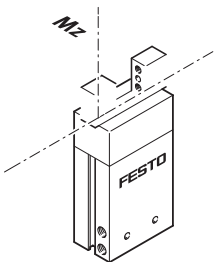

The indicated permissible forces and torques apply to a single gripper jaw. The indicated values include the lever arm, additional weight forces caused by the workpiece or external gripper fingers, as well as forces which occur during movement. The zero coordinate line (gripper jaw guide) must be taken into consideration when calculating torques.

Size	16	25
Max. permissible force F_z	[N] 90	240
Max. permissible torque M_x	[Nm] 3.3	11
Max. permissible torque M_y	[Nm] 3.3	11
Max. permissible torque M_z	[Nm] 3.3	11

Data sheet

Mass moments of inertia [$\text{kgm}^2 \times 10^{-4}$]

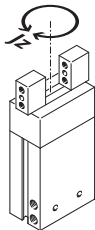

Mass moment of inertia [$\text{kgm}^2 \times 10^{-4}$] for parallel grippers in relation to the central axis, without external gripper fingers, without load.

Size	16	25
HGP...	0.47	3.83

Opening and closing times [ms] at 6 bar

Without external gripper fingers

With external gripper fingers

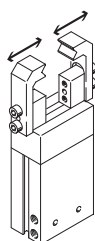
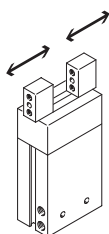

The indicated opening and closing times [ms] have been measured at room temperature and 6 bar operating pressure without additional gripper fingers. The grippers must be throttled for larger masses [g]. Opening and closing times must then be adjusted accordingly.

Size	16		25
Without external gripper fingers			
HGP...	Opening	44	47
	Closing	60	50
With external gripper fingers (as a function of the mass per gripper finger)			
HGP...	100 g	100	–
	150 g	200	100
	200 g	300	200
	300 g	–	300

Data sheet

Gripping force F_H per gripper jaw as a function of operating pressure and lever arm x

External and internal gripping (closing and opening)

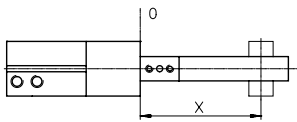

The gripping forces as a function of operating pressure and lever arm (distance from the zero co-ordinate line shown above to the pressure point at which the fingers grip the workpiece) can be determined for the various sizes using the following graphs.

HGP-16-...

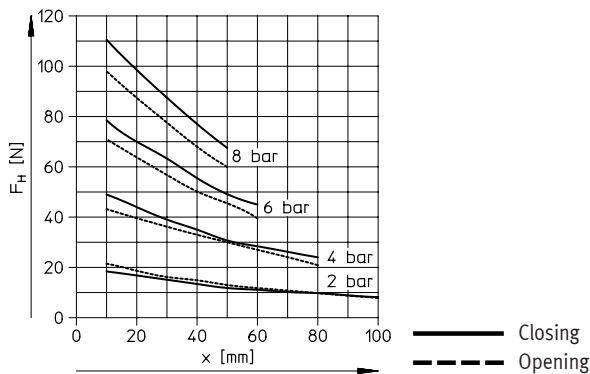

HGP-25-...

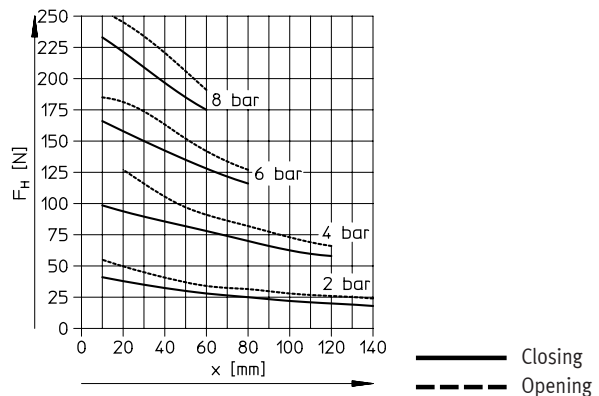

Gripping force F_H per gripper jaw at 6 bar as a function of lever arm x and eccentricity y

External and internal gripping (closing and opening)

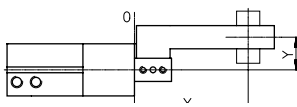

The gripping forces at 6 bar as a function of eccentric application of force (distance from the zero co-ordinate line shown above to the pressure point at which the fingers grip the workpiece) and the maximum permissible off-centre point at which force is applied can be determined for the various sizes using the following graphs.

Calculation example

Assuming:

HGP-16-A-B-SSK

Lever arm $x = 20$ mm

Eccentricity $y = 22$ mm

Required:

Gripping force at 6 bar

Procedure:

- Determine the intersection xy between lever arm x and eccentricity y in the graph for HGP-16-...

- Draw an arc (with centre at origin) through intersection xy
 - Determine the intersection between the arc and X-axis
 - Read the gripping force
- Result:
gripping force = approx. 66 N

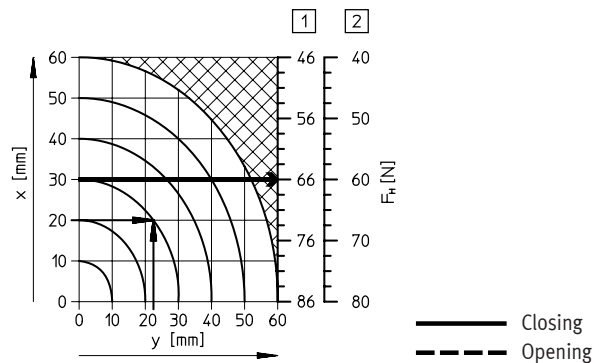

HGP-16-...

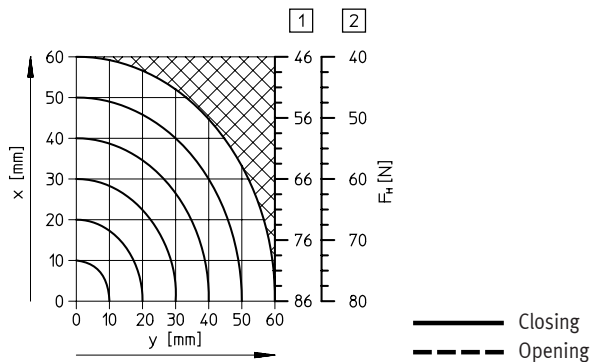

HGP-25-...

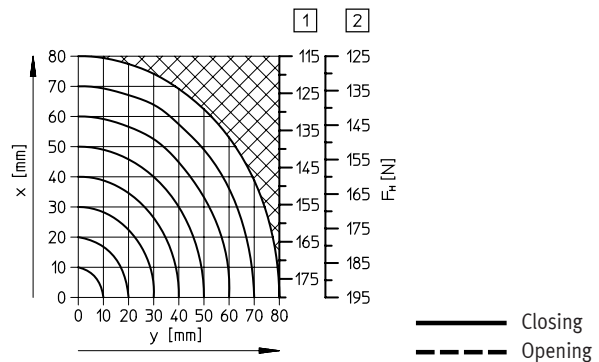

Data sheet

Dimensions

Download CAD data → www.festo.com

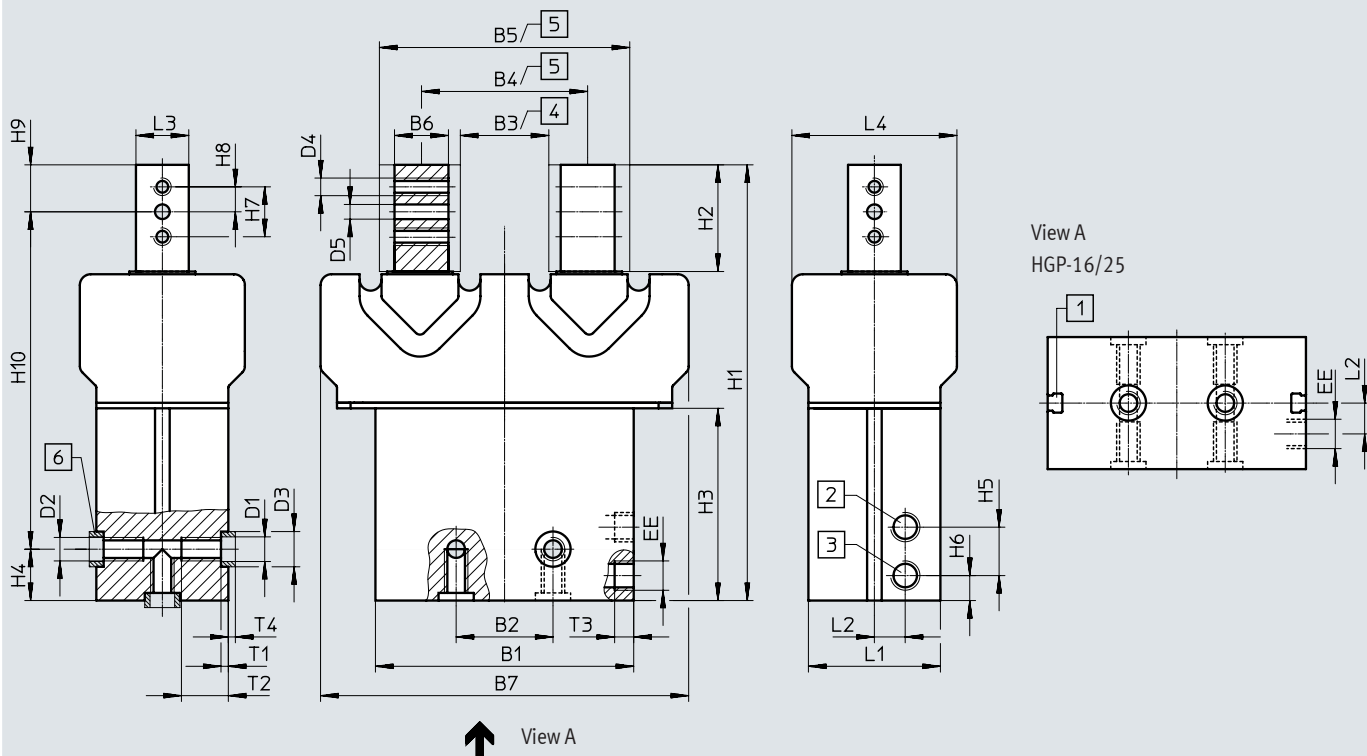

- [1] Sensor slot for proximity switch SME/SMT-8
Proximity switches SME-/SMT-10 can also be used in combination with the bondable sensor rail.
- [2] Compressed air supply port, opening
- [3] Compressed air supply port, closing
- [4] Closed
- [5] Open
- [6] Centring sleeves ZBH (2 included in the scope of delivery)

The distance $H5 = 7$ mm between the two air connections on types HGP-16 means that only the following fittings can be used:

- QSM-M3-3
- QSML-M3-3
- QSMLL-M3-3
- CN-M3-PK-3
- LCN-M3-PK-3

Size	B1	B2 ¹⁾	B3	B4	B5	B6	B7	D1	D2	D3	D4	D5	EE	H1	H2	H3
[mm]		±0.1	±0.5	±0.5	±0.5	-0.03	±0.5	∅		∅ H8/h7		∅ H8				
16	47	25	16.4	26.4	46.4	10	67	5.3	M4	7	M4	3	M3	83	20.5	38.1
25	68.2	29	21	36	66	15	101	6.4	M6	9	M5	4	G1/8	126.8	31.5	58.8

Size	H4 ²⁾	H5	H6	H7	H8	H9	H10	L1	L2	L3	L4	T1	T2	T3	T4
[mm]	±0.1						±0.2			-0.03		+0.1	+1	+0.5	-0.3
16	7.5	7	4	11	5.5	10	65.5	22	5.7	10	30	1.6	7.5	3.5	1.4
25	17.5	16.5	8.3	16	8	15	94.3	37	10.5	15	47	2.1	15	6.5	1.9

1) Tolerance for centring hole: ±0.02

2) Tolerance for centring hole: -0.05

- ♪ - Note: This product conforms to ISO 1179-1 and ISO 228-1.

Ordering data

Size	Part no.	Type
[mm]		
16	539636	HGP-16-A-B-SSK
25	539635	HGP-25-A-B-SSK

Accessories

Sensor rail HGP-SL

Bondable

Material:

Wrought aluminium alloy

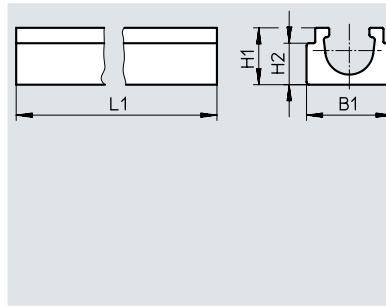



Dimensions and ordering data							
For size [mm]	H1 +0.05	H2 +0.05/-0.1	B1 -0.1	L1	Weight [g]	Part no.	Type
16	4.25	3.1	6.4	38	1.5	535583	HGP-SL-10-16
25	4.25	3.1	6.4	58	2.3	535585	HGP-SL-10-25

Ordering data							
Type	For size	Weight [g]	Part no.	Type	PU ¹⁾		
Centring sleeve ZBH							
						Data sheets →	Internet: zbh
	16	1	8146544	ZBH-7-B	10		
	25		8137184	ZBH-9-B			

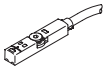
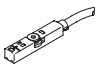

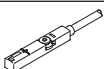
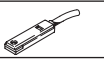
1) Packaging unit



Ordering data – Proximity switch for T-slot, magneto-resistive							Data sheets →	Internet: smt
	Type of mounting	Switching output	Electrical connection	Cable length [m]	Part no.	Type		
N/O contact								
	Inserted in the slot from above, flush with the cylinder profile, short design	PNP	Cable, 3-wire	2.5	574335	SMT-8M-A-PS-24V-E-2.5-OE		
			Plug M8x1, 3-pin	0.3	574334	SMT-8M-A-PS-24V-E-0.3-M8D		
			Plug M12x1, 3-pin	0.3	574337	SMT-8M-A-PS-24V-E-0.3-M12		
		NPN	Cable, 3-wire	2.5	574338	SMT-8M-A-NS-24V-E-2.5-OE		
			Plug M8x1, 3-pin	0.3	574339	SMT-8M-A-NS-24V-E-0.3-M8D		
N/C contact								
	Inserted in the slot from above, flush with the cylinder profile, short design	PNP	Cable, 3-wire	7.5	574340	SMT-8M-A-PO-24V-E-7.5-OE		

Ordering data – Proximity switch for T-slot, magnetic reed							Data sheets →	Internet: sme	
	Type of mounting	Switching output	Electrical connection	Cable length [m]	Part no.	Type			
N/O contact									
	Inserted in the slot from above, flush with the cylinder profile	Contacting	Cable, 3-wire	2.5	543862	SME-8M-DS-24V-K-2.5-OE			
					5.0	543863	SME-8M-DS-24V-K-5.0-OE		
				Cable, 2-wire	2.5	543872	SME-8M-ZS-24V-K-2.5-OE		
				Plug M8x1, 3-pin	0.3	543861	SME-8M-DS-24V-K-0.3-M8D		
	Inserted in the slot lengthwise, flush with the cylinder profile	Contacting	Cable, 3-wire	2.5	150855	SME-8-K-LED-24			
				Plug M8x1, 3-pin	0.3	150857	SME-8-S-LED-24		
N/C contact									
	Inserted in the slot lengthwise, flush with the cylinder profile	Contacting	Cable, 3-wire	7.5	160251	SME-8-O-K-LED-24			

Accessories

Ordering data – Proximity switch for C-slot, magneto-resistive						Data sheets → Internet: smt
	Type of mounting	Switching output	Electrical connection, outlet direction of connection	Cable length [m]	Part no.	Type
N/O contact						
	Inserted in the slot from above	PNP	Cable, 3-wire, lengthwise	2.5	551373	SMT-10M-PS-24V-E-2.5-L-OE
			Plug M8x1, 3-pin, in-line	0.3	551375	SMT-10M-PS-24V-E-0.3-L-M8D
			Plug M8x1, 3-pin, lateral	0.3	551376	SMT-10M-PS-24V-E-0.3-Q-M8D

Ordering data – Proximity switch for C-slot, magnetic reed						Data sheets → Internet: sme
	Type of mounting	Switching output	Electrical connection, outlet direction of connection	Cable length [m]	Part no.	Type
N/O contact						
	Inserted in the slot from above	Contacting	Plug M8x1, 3-pin, in-line	0.3	551367	SME-10M-DS-24V-E-0.3-L-M8D
			Cable, 3-wire, lengthwise	2.5	551365	SME-10M-DS-24V-E-2.5-L-OE
			Cable, 2-wire, lengthwise	2.5	551369	SME-10M-ZS-24V-E-2.5L-OE
	Inserted in the slot lengthwise	Contacting	Plug M8x1, 3-pin, in-line	0.3	173212	SME-10-SL-LED-24
			Cable, 3-wire, lengthwise	2.5	173210	SME-10-KL-LED-24

Ordering data – Connecting cables					Data sheets → Internet: nebu
	Electrical connection, left	Electrical connection, right	Cable length [m]	Part no.	Type
	Straight socket, M8x1, 3-pin	Cable, open end, 3-wire	2.5	541333	NEBU-M8G3-K-2.5-LE3
			5	541334	NEBU-M8G3-K-5-LE3
	Straight socket, M12x1, 5-pin	Cable, open end, 3-wire	2.5	541363	NEBU-M12G5-K-2.5-LE3
			5	541364	NEBU-M12G5-K-5-LE3
	Angled socket, M8x1, 3-pin	Cable, open end, 3-wire	2.5	541338	NEBU-M8W3-K-2.5-LE3
			5	541341	NEBU-M8W3-K-5-LE3
	Angled socket, M12x1, 5-pin	Cable, open end, 3-wire	2.5	541367	NEBU-M12W5-K-2.5-LE3
			5	541370	NEBU-M12W5-K-5-LE3

Festo - Your Partner in Automation



1 Festo Inc.
5300 Explorer Drive
Mississauga, ON L4W 5G4
Canada

Festo Customer Interaction Center
Tel: 1 877 463 3786
Fax: 1 877 393 3786
Email: customer.service.ca@festo.com



2 Festo Pneumatic
Av. Ceylán 3,
Col. Tequesquináhuac
54020 Tlalnepantla,
Estado de México

Multinational Contact Center
01 800 337 8669
ventas.mexico@festo.com



3 Festo Corporation
1377 Motor Parkway
Suite 310
Islandia, NY 11749

Festo Customer Interaction Center
1 800 993 3786
1 800 963 3786
customer.service.us@festo.com



4 Regional Service Center
7777 Columbia Road
Mason, OH 45040

Connect with us



www.festo.com/socialmedia



www.festo.com

Subject to change