

One-way flow control valves GRLA, GRLZ

FESTO



Festo Core Range
Solves the majority of your automation tasks

Worldwide: Quickest delivery – wherever, whenever
Simply good: Expected high Festo quality
Fast: Easy and fast to select

With the Festo Core Range, we have selected the most important products and functions from our broad product catalogue, and added the quickest delivery.

The Core Range offers you the best value for your automation tasks.

Just look
for the
star!

Key features

Function

The piston speed of both advancing and retracting pneumatic cylinders can be regulated using one-way flow control valves.

This is achieved by restricting the flow rate of compressed air in exhaust air or supply air direction as required. The non-return function works in the opposite direction.

The flow control function creates an adjustable annular gap inside the valve. This gap can be increased or decreased by turning the knurled screw or slotted head screw.

The required restriction can be set with the help of this adjustment element.

General information

Standard nominal flow rate q_{nN}

The standard nominal flow rate q_{nN} is the volumetric flow rate based on standard conditions at an operating pressure of $p_1 = 6$ bar and an output pressure of $p_2 = 5$ bar, measured at room temperature $t = 20^\circ\text{C}$.

Standard flow rate q_n

The standard flow rate q_n is measured at an operating pressure of $p_1 = 6$ bar and an output pressure with respect to atmospheric pressure ($p_2 = 0$ bar).

Symbols

Exhaust air one-way flow control function

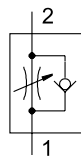

Supply air one-way flow control function

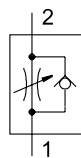

Connections

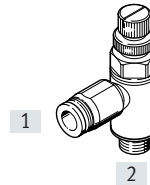

- [1] Pneumatic connection 1 (compressed air connection)
- [2] Pneumatic connection 2 (working port)

Key features

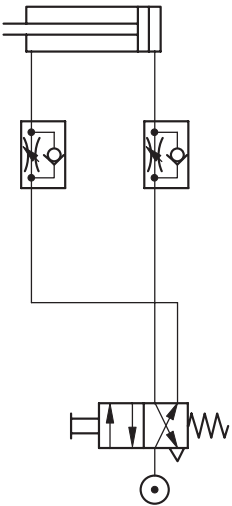
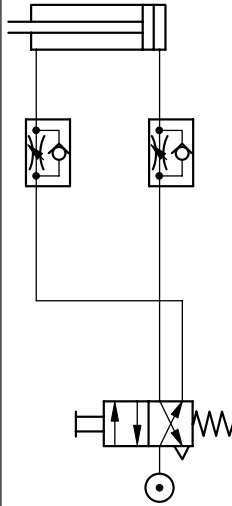
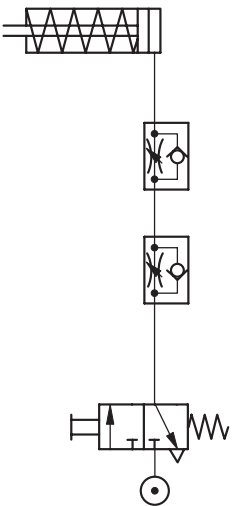
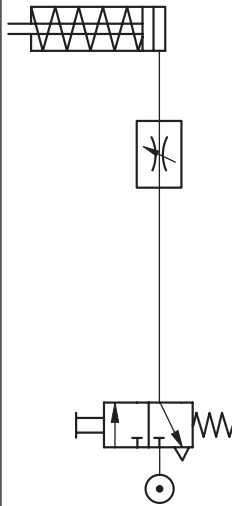
Flow control functions and range of applications	
Application	Description
Double-acting cylinder with one-way flow control valve	
Exhaust air one-way flow control function	Speed is adjustable using exhaust air flow control. Free flowing supply air and throttled exhaust air ensure that the piston moves between the air pockets (improves motion, even with load changes).
	
Supply air one-way flow control function	Speed for advance and return strokes can be adjusted. The flow rate is identical in both directions.
	
Single-acting cylinder with one-way flow control valve	
Exhaust air and supply air one-way flow control function	Speed for advance and return strokes can be adjusted. The flow rate can be adjusted differently for both directions.
	
Single-acting cylinder with flow control valve	Flow control function in both directions
	Speed adjustment through flow control on both sides is often used with single-acting or small cylinders. The benefit of this application is its simplicity.







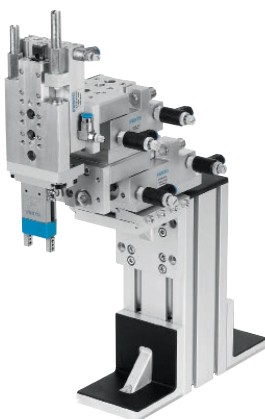





Application examples

Mini slide SLT with one-way flow control valve, standard

Flat cylinder DZF with one-way flow control valve, mini







Product range overview – One-way flow control valves

Version	Valve function	Version	Type	Outlet direction of connection	Pneumatic connection 1	Pneumatic connection 2	qn ¹⁾ [l/min]	Adjusting element	→ Page/ Internet
Standard									
Polymer									
	Exhaust air one-way flow control function		VFOE-LE	Elbow outlet	QS-4, QS-6, QS-8, QS-10, QS-12	M5, G1/8, G1/4, G3/8, G1/2, R1/8, R1/4, R3/8, R1/2	90 ... 1200	Rotary knob with latch	vfoe
	Supply air one-way flow control function		VFOE-LS	Elbow outlet	QS-4, QS-6, QS-8	M5, M7, G1/8, R1/8	90 ... 180	Rotary knob with latch	vfoe
Metal									
	Exhaust air one-way flow control function		GRLA	Elbow outlet	QS-3, QS-4, QS-6, QS-8, QS-10, QS-12	M5, G1/8, G1/4, G3/8, G1/2	100 ... 1580	Slotted head screw	7
								Knurled screw	
								Slotted head screw	
								Knurled screw	
	Exhaust air one-way flow control function		GRLSA	Elbow outlet	QS-6, QS-8	G1/8, G1/4	0 ... 450	Rotary knob with scale, internal hex	16
		Supply air one-way flow control function	GRLZ	Elbow outlet	QS-3, QS-4, QS-6, QS-8	M5, G1/8	100 ... 215	Slotted head screw	7
								Slotted head screw	
								Knurled screw	
			Slotted head screw						
	Supply air one-way flow control function		VFOC-S	Elbow outlet	QS-4, QS-6	Push-in sleeve ²⁾ QS-4, QS-6	0 ... 270	Slotted head screw	vfoc
Nickel-plated metal									
	Exhaust air one-way flow control function		VFOH-LE	Elbow outlet	QS-4, QS-6, QS-8, QS-10	G1/8, G1/4	180 ... 530	External hex	vfoh

1) Standard nominal flow rate in flow control direction.

2) Only suitable for push-in connector QS.

Product range overview – One-way flow control valves

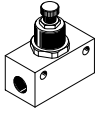
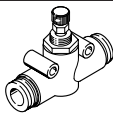
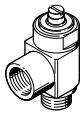
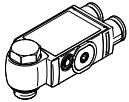
Version	Valve function	Version	Type	Outlet direction of connection	Pneumatic connection 1	Pneumatic connection 2	qnN ¹⁾ [l/min]	Adjusting element	→ Page/ Internet
Mini	Metal Exhaust air one-way flow control function		GRLA	Elbow outlet	QS-3, QS-4	M3, M5	40 ... 41	Slotted head screw	19
					M3	M3	0 ... 18	Slotted head screw	
	Supply air one-way flow control function		GRLZ	Elbow outlet	QS-3, QS-4	M3, M5	41 ... 48	Slotted head screw	
					M3	M3	0 ... 18	Slotted head screw	
In-line installation	Metal One-way flow control function		GR/GRA	Straight	M3, M5, G1/8, G1/4, G3/8, G1/2, G3/4	M3, M5, G1/8, G1/4, G3/8, G1/2, G3/4	29.5 ... 3300	Knurled screw	gr
		Polymer One-way flow control function		GR	Straight	QS-3, QS-4, QS-6, QS-8	QS-3, QS-4, QS-6, QS-8	85 ... 265	Knurled screw
Corrosion-resistant	Stainless steel Exhaust air one-way flow control function		CRGRLA	Elbow outlet	M5, G1/8, G1/4, G3/8, G1/2	M5, G1/8, G1/4, G3/8, G1/2	95 ... 2100	Slotted head screw	24
Function combination	Polymer Exhaust air one-way flow control function		VFOF	Elbow outlet	QS-6, QS-8	G1/8, G1/4	240 ... 590	Internal hex	vfof

1) Standard nominal flow rate in flow control direction.

Type codes

001	Series
GRLA	One-way flow control valve
GRLSA	One-way flow control valve
CRGRLA	One-way flow control valve, corrosion resistant
GRLZ	One-way flow control valve

002	Pneumatic connection
M3	Male thread M3
M5	Male thread M5
1/8	Male thread G1/8
1/4	Male thread G1/4
3/8	Male thread G3/8
1/2	Male thread G1/2
3/4	Male thread G3/4

003	Pneumatic connection 1
	Connection size as for port 1 or 2
QS-3	Push-in connector 3 mm
QS-4	Push-in connector 4 mm
QS-6	Push-in connector 6 mm
QS-8	Push-in connector 8 mm
QS-10	Push-in connector 10 mm
QS-12	Push-in connector 12 mm
PK-3	CK connection 3 mm
PK-4	CK connection 4 mm
PK-6	CK connection 6 mm

004	Adjusting component
	Standard
RS	Knurled screw

005	Flow rate characteristic
	None
LF	Low flow
MF	Medium flow

006	Generation
	None
B	Series B
C	Series C
D	D series



Datasheet – Push-in connector QS, metal

One-way flow control function

Exhaust air

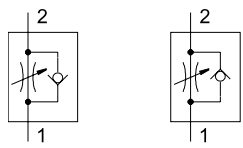
Supply air



-  - Flow rate
100 ... 1580 l/min
-  - Temperature range
-10 ... +60°C
-  - Operating pressure
0.2 ... 10 bar

Can be rotated 360° around the screw-in axis after installation.



General technical data – GRLA

Pneumatic connection 2	M5	G1/8	G1/4	G3/8	G1/2
Pneumatic connection 1	QS-3, QS-4, QS-6	QS-3, QS-4, QS-6, QS-8	QS-6, QS-8, QS-10	QS-6, QS-8, QS-10	QS-12
Valve function	Exhaust air one-way flow control function				
Adjusting element	Slotted head screw				
	Knurled screw				
Type of mounting	Screw-in, via male thread				
Mounting position	Any				
Nominal tightening torque [Nm]	0.8 ±10%	3 ±10%	5 ±10%	10 ±10%	15 ±10%

General technical data – GRLZ

Pneumatic connection 2	M5	G1/8
Pneumatic connection 1	QS-3, QS-4, QS-6	QS-3, QS-4, QS-6, QS-8
Valve function	Supply air one-way flow control function	
Adjusting element	Slotted head screw	
Type of mounting	Screw-in, via male thread	
Mounting position	Any	
Nominal tightening torque [Nm]	0.8 ±10%	3 ±10%

Operating and environmental conditions

Operating pressure for entire temperature range [bar]	0.2 ... 10
Operating medium	Compressed air to ISO 8573-1:2010 [7:4:4]
Note on the operating/pilot medium	Lubricated operation possible (in which case lubricated operation will always be required)
Ambient temperature [°C]	-10 ... +60
Temperature of medium [°C]	-10 ... +60
Storage temperature [°C]	-10 ... +40
Maritime classification	See certificate ¹⁾

1) More information: www.festo.com/catalogue/grla → Support/Downloads

Standard nominal flow rate q_{nN} at 6 → 5 bar as a function of spindle rotations n

GRLA/GRLZ-M5

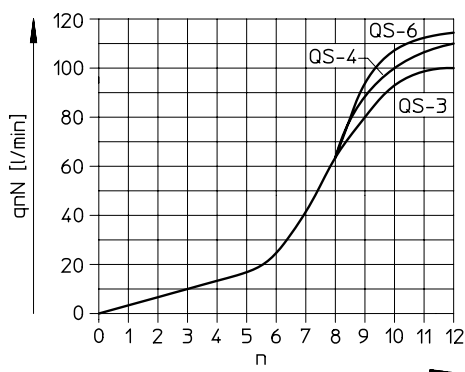

Standard flow rate q_n at 6 → 0 bar as a function of spindle rotations n

GRLA/GRLZ-M5

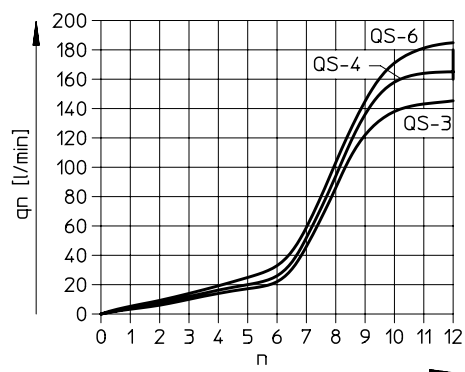

Datasheet – Push-in connector QS, metal

Standard nominal flow rate q_{nN} at 6 → 5 bar as a function of spindle rotations n

GRLA/GRLZ-1/8

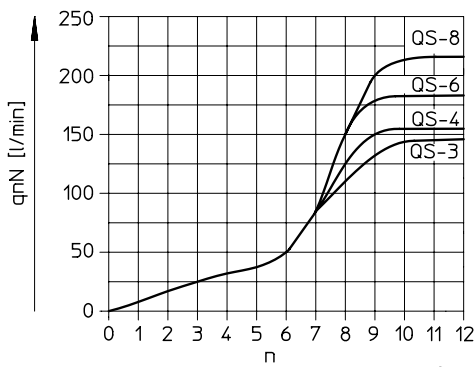

Standard flow rate q_n at 6 → 0 bar as a function of spindle rotations n

GRLA/GRLZ-1/8

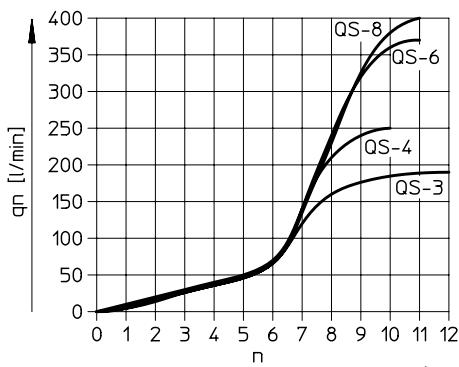

GRLA-1/8...-MF, GRLA-1/4

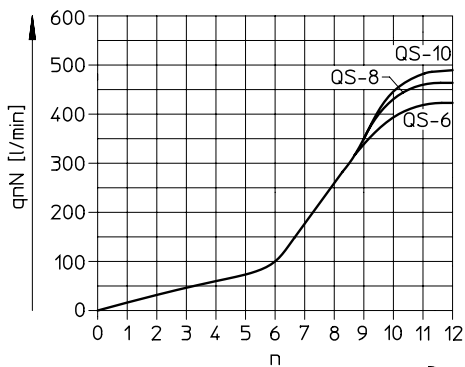

GRLA-1/8...-MF, GRLA-1/4

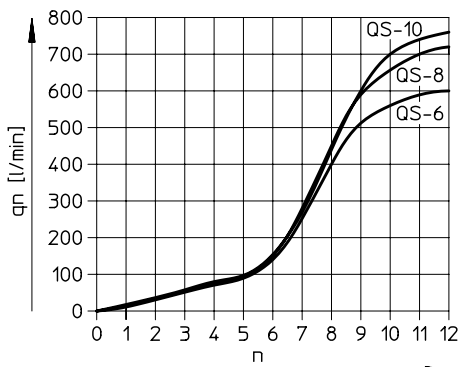

GRLA-3/8

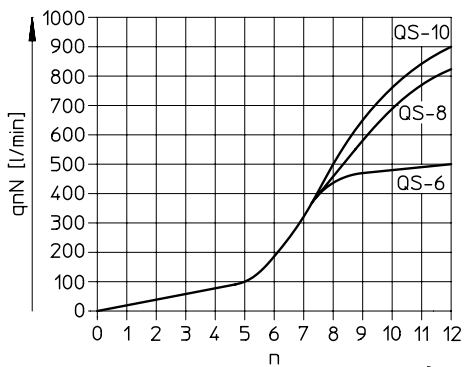

GRLA-3/8

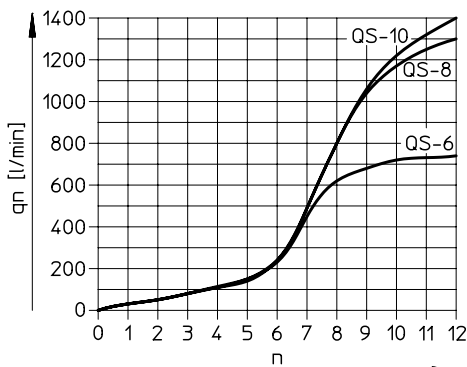

GRLA-1/2

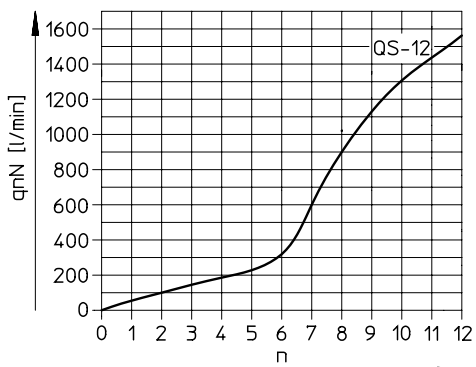

GRLA-1/2

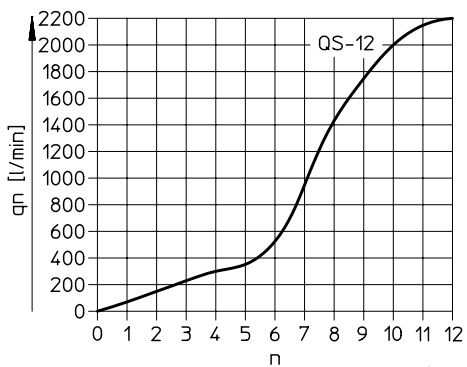

Datasheet – Push-in connector QS, metal

Materials

Sectional view

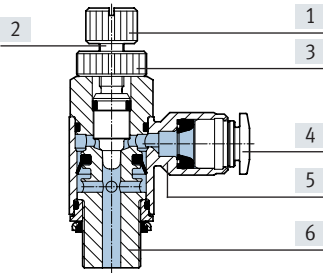

One-way flow control valve

[1]	Knurled head (GRLA-...-RS only)	Anodised wrought aluminium alloy
[2]	Adjusting screw	Brass
[3]	Hollow bolt (GRLA-...-RS only)	Anodised wrought aluminium alloy
[4]	Releasing ring	POM
[5]	Swivel joint	Chromated die-cast zinc
[6]	Screwed trunnion	Anodised wrought aluminium alloy GRLA/GRLZ-M5: Brass
-	Seals	NBR
Note on materials		RoHS-compliant
LABS (PWIS) conformity		VDMA24364-B1/B2-L

Dimensions

Slotted head screw

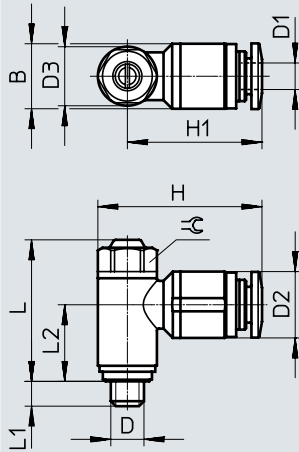

Knurled screw

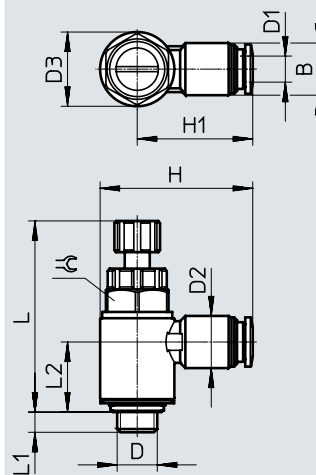

Download CAD data → www.festo.com

Type	Connection D	Tubing O.D. D1	B	D2 ø	D3 ø	~H	~H1	~L		L1	~L2	⊕
								Slotted head screw	Knurled screw			
GRL...-M5	M5	3	-	8.2 +0.15	8.9 ±0.07	22.4	18	20.8 ±3.3%	31.5 ±2.4%	3.9 +0.1/-0.45	10.7	8
		4	9.8 ±0.2	10.0 ±0.2		24.7	20.3				9.7	
		6	-	12.0 ±0.2		26.5	22					
GRL...-1/8	G1/8	3	-	10.2 ±0.2	13.8 ±0.07	31.9	25	26.5 ±2.1%	40.4 ±1.6%	5.05 +0.15/-0.3	14.2	12
		4		10.2 ±0.2		29.4	22.5				13.5	
		6		12.5 ±0.2		32.6	25.7					
		8		14.5 ±0.2		35.6	28.7					
GRLA-1/8-...-MF	G1/8	6	-	12.5 ±0.2	17.8 ±0.15	36.6	27.7	30.9 ±1.9%	-	5.05 +0.15/-0.3	17	15
		8		14.5 ±0.2		39.6	30.7					
GRLA-1/4	G1/4	6	-	12.5 ±0.2	17.8 ±0.15	36.6	27.7	31.5 ±1.9%	48.5 ±1.4%	5.9 +0.17/-0.25	17.2	15
		8		14.5 ±0.2		39.6	30.7				16.1	
		10		17.5 ±0.2		42.0	33.1					
GRLA-3/8	G3/8	6	-	12.5 ±0.2	22.4 ±0.15	39.8	28.6	35.3 ±1.7%	55 ±1.3%	6.9 +0.15/-0.3	19.55	19
		8		14.5 ±0.2		44.1	32.9					
		10		17.5 ±0.2		46.7	35.5					
GRLA-1/2	G1/2	12	-	20.5 ±0.15	27.8 ±0.15	55.3	41.4	42.6 ±1.4%	65.9 ±1.1%	8.35 +0.15/-0.3	22.75	24

Datasheet – Push-in connector QS, metal

★ Core Range

Pneumatic connection		Standard nominal flow rate qnN At 6 → 5 bar		Standard flow rate qn At 6 → 0 bar		Weight [g]	Part no.	Type
2	1	In flow control direction [l/min]	In non-return direction [l/min]	In flow control direction [l/min]	In non-return direction [l/min]			

Slotted head screw



M5	QS-3	100	60 ... 100	145	150 ... 170	13	★ 193137	GRLA-M5-QS-3-D	
	QS-4	110	65 ... 110	165	140 ... 160		★ 193138	GRLA-M5-QS-4-D	
	QS-6	115	70 ... 110	185	145 ... 170		★ 193139	GRLA-M5-QS-6-D	
	G1/8	QS-3	130	100 ... 130	180	200 ... 220	22	★ 193142	GRLA-1/8-QS-3-D
		QS-4	160	120 ... 190	250	270 ... 300		★ 193143	GRLA-1/8-QS-4-D
		QS-6	185	160 ... 240	370	330 ... 390	32	★ 193144	GRLA-1/8-QS-6-D
			400	290 ... 420	600	570 ... 680		★ 537075	GRLA-1/8-QS-6-MF-D
		QS-8	215	175 ... 250	400	330 ... 410	22	★ 193145	GRLA-1/8-QS-8-D
			475	325 ... 500	720	610 ... 760		★ 537076	GRLA-1/8-QS-8-MF-D
	G1/4	QS-6	400	290 ... 420	600	570 ... 680	42	★ 193146	GRLA-1/4-QS-6-D
		QS-8	475	325 ... 500	720	610 ... 760		★ 193147	GRLA-1/4-QS-8-D
		QS-10	480	345 ... 500	760	630 ... 790		★ 193148	GRLA-1/4-QS-10-D
G3/8	QS-6	495	320 ... 495	740	840 ... 890	60	★ 193149	GRLA-3/8-QS-6-D	
	QS-8	820	450 ... 850	1300	1080 ... 1420		★ 193150	GRLA-3/8-QS-8-D	
	QS-10	900	540 ... 975	1400	1160 ... 1620		★ 193151	GRLA-3/8-QS-10-D	
G1/2	QS-12	1580	925 ... 1605	2220	1910 ... 2500	106	★ 193152	GRLA-1/2-QS-12-D	

Knurled screw



M5	QS-3	100	60 ... 100	145	150 ... 170	14	★ 197576	GRLA-M5-QS-3-RS-D
	QS-4	110	65 ... 110	165	140 ... 160		★ 197577	GRLA-M5-QS-4-RS-D
	QS-6	115	70 ... 110	185	145 ... 170		★ 197578	GRLA-M5-QS-6-RS-D
G1/8	QS-3	130	100 ... 130	180	200 ... 220	23	★ 197579	GRLA-1/8-QS-3-RS-D
	QS-4	160	120 ... 190	250	270 ... 300		★ 197580	GRLA-1/8-QS-4-RS-D
	QS-6	185	160 ... 240	370	330 ... 390	24	★ 197581	GRLA-1/8-QS-6-RS-D
		215	175 ... 250	400	330 ... 410		★ 534337	GRLA-1/8-QS-8-RS-D
G1/4	QS-6	400	290 ... 420	600	570 ... 680	50	★ 534338	GRLA-1/4-QS-6-RS-D
	QS-8	475	325 ... 500	720	610 ... 760		★ 534339	GRLA-1/4-QS-8-RS-D
	QS-10	480	345 ... 500	760	630 ... 790		★ 534340	GRLA-1/4-QS-10-RS-D
G3/8	QS-6	495	320 ... 495	740	840 ... 890	72	★ 534341	GRLA-3/8-QS-6-RS-D
	QS-8	820	450 ... 850	1300	1080 ... 1420		★ 534342	GRLA-3/8-QS-8-RS-D
	QS-10	900	540 ... 975	1400	1160 ... 1620		★ 534343	GRLA-3/8-QS-10-RS-D
G1/2	QS-12	1580	925 ... 1605	2220	1910 ... 2500	124	★ 534344	GRLA-1/2-QS-12-RS-D

Ordering data – Supply air one-way flow control function

Pneumatic connection		Standard nominal flow rate qnN At 6 → 5 bar		Standard flow rate qn At 6 → 0 bar		Weight [g]	Part no.	Type
2	1	In flow control direction [l/min]	In non-return direction [l/min]	In flow control direction [l/min]	In non-return direction [l/min]			

Slotted head screw



M5	QS-3	100	60 ... 100	135	130 ... 160	13	★ 193153	GRLZ-M5-QS-3-D
	QS-4	110	65 ... 110	160	150 ... 180		★ 193154	GRLZ-M5-QS-4-D
	QS-6	115	70 ... 110	170	160 ... 200		★ 193155	GRLZ-M5-QS-6-D
G1/8	QS-3	130	100 ... 130	200	180 ... 200	22	★ 193156	GRLZ-1/8-QS-3-D
	QS-4	160	120 ... 190	300	260 ... 290		★ 193157	GRLZ-1/8-QS-4-D
	QS-6	185	160 ... 240	340	390 ... 460	22	★ 193158	GRLZ-1/8-QS-6-D
		215	175 ... 250	370	390 ... 470		★ 193159	GRLZ-1/8-QS-8-D

Datasheet – Female thread/barbed connector, metal

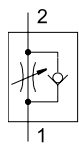

One-way flow control function

Exhaust air

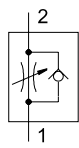

Supply air



-  - Flow rate
83 ... 4320 l/min
-  - Temperature range
-10 ... +60°C
-  - Operating pressure
0.2 ... 10 bar

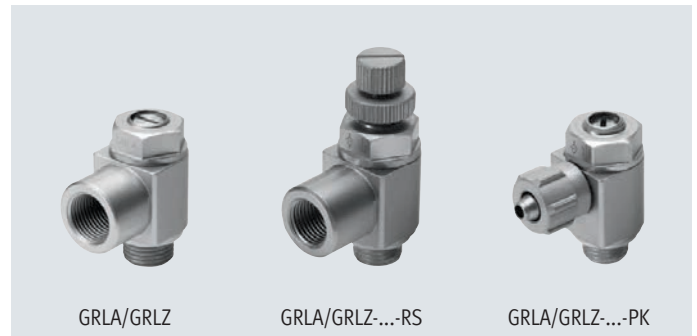

GRLA/GRLZ

GRLA/GRLZ-...-RS

GRLA/GRLZ-...-PK

General technical data – GRLA

Connection type	Female thread						Barbed connector		
	M5	G1/8	G1/4	G3/8	G1/2	G3/4	M5	G1/8	G1/4
Pneumatic connection 2	M5	G1/8	G1/4	G3/8	G1/2	G3/4	M5	G1/8	G1/4
Pneumatic connection 1	M5 ¹⁾	G1/8 ¹⁾	G1/4 ¹⁾	G3/8 ¹⁾	G1/2 ¹⁾	G3/4 ¹⁾	PK-3, PK-4	PK-3, PK-4, PK-6	PK-4, PK-6
Valve function	Exhaust air one-way flow control function								
Adjusting element	Slotted head screw								
	Knurled screw						-		
Type of mounting	Screw-in								
Mounting position	Any								
Max. tightening torque [Nm]	1.5	6	11	20	40	60	1.5	6	11

 1)  Note: This product conforms to ISO 1179-1 and ISO 228-1.

General technical data – GRLZ

Connection type	Female thread			Barbed connector		
	M5	G1/8	G1/4	M5	G1/8	G1/4
Pneumatic connection 2	M5	G1/8	G1/4	M5	G1/8	G1/4
Pneumatic connection 1	M5 ¹⁾	G1/8 ¹⁾	G1/4 ¹⁾	PK-3, PK-4	PK-3, PK-4, PK-6	PK-4, PK-6
Valve function	Supply air one-way flow control function					
Adjusting element	Slotted head screw					
	Knurled screw			-		
Type of mounting	Screw-in					
Mounting position	Any					
Max. tightening torque [Nm]	1.5	6	11	1.5	6	11

 1)  Note: This product conforms to ISO 1179-1 and ISO 228-1.

Operating and environmental conditions

Pneumatic connection 2	M5	G1/8	G1/4	G3/8	G1/2	G3/4
Operating pressure for entire temperature range [bar]	0.2 ... 10		0.3 ... 10			
Operating medium	Compressed air to ISO 8573-1:2010 [7:4:4]					
Note on the operating/pilot medium	Lubricated operation possible (in which case lubrication will always be required)					
Ambient temperature [°C]	-10 ... +60					
Temperature of medium [°C]	-10 ... +60					
Storage temperature [°C]	-10 ... +40					
Maritime classification	GRLA: see certificate ¹⁾					

 1) More information: www.festo.com/catalogue/grla → Support/Downloads

Datasheet – Female thread/barbed connector, metal

Standard nominal flow rate q_{nN} at 6 → 5 bar as a function of spindle rotations n

GRLA/GRLZ-M5

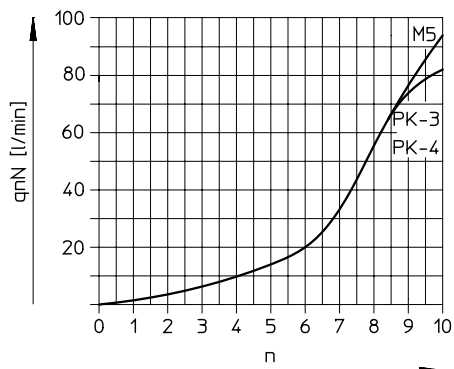

Standard flow rate q_n at 6 → 0 bar as a function of spindle rotations n

GRLA/GRLZ-M5

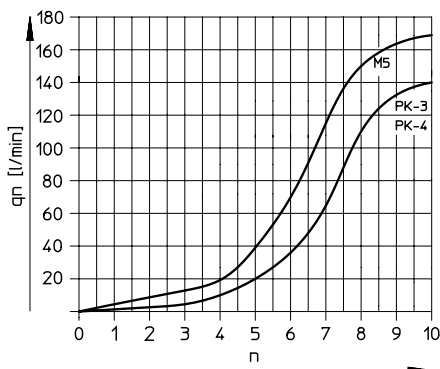

GRLA/GRLZ-1/8

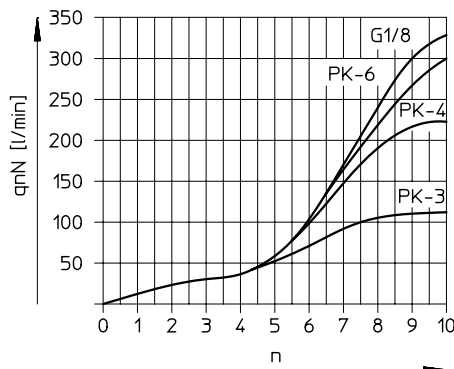

GRLA/GRLZ-1/8

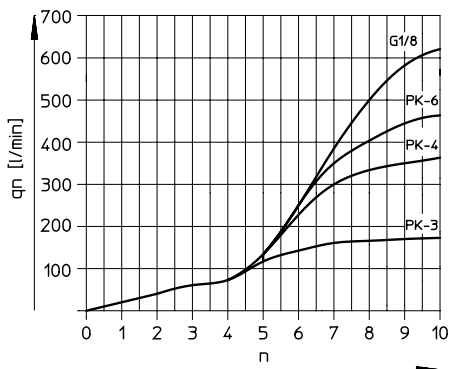

GRLA/GRLZ-1/4

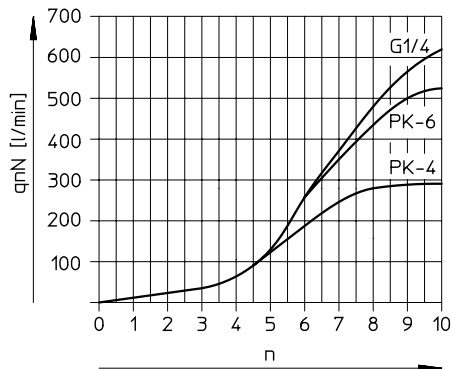

GRLA/GRLZ-1/4

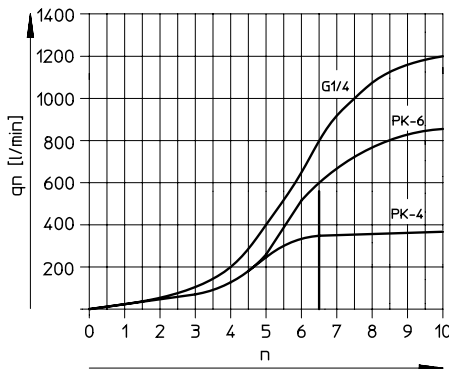

Datasheet – Female thread/barbed connector, metal

Standard nominal flow rate q_{nN} at 6 → 5 bar as a function of spindle rotations n

GRLA-3/8

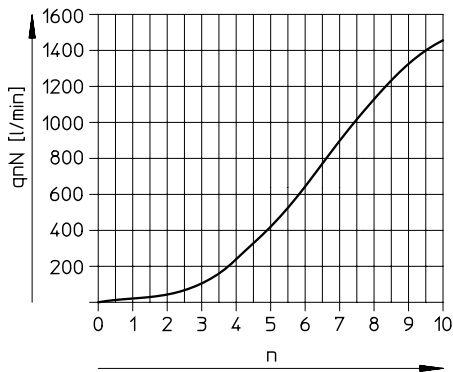

GRLA-1/2

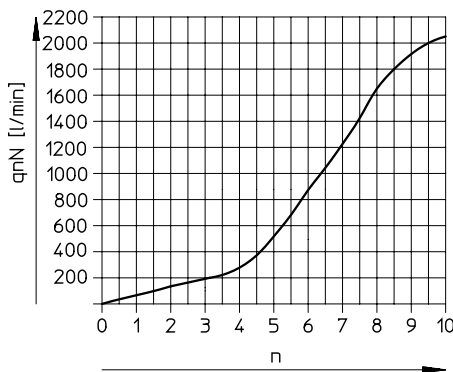

GRLA-3/4

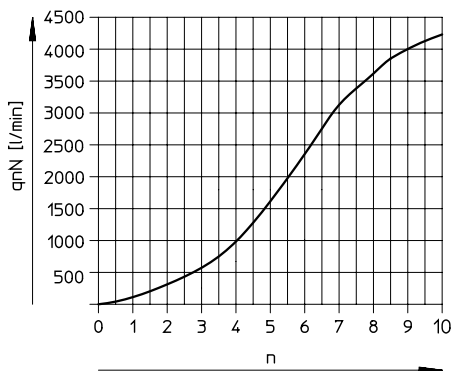

Standard flow rate q_n at 6 → 0 bar as a function of spindle rotations n

GRLA-3/8

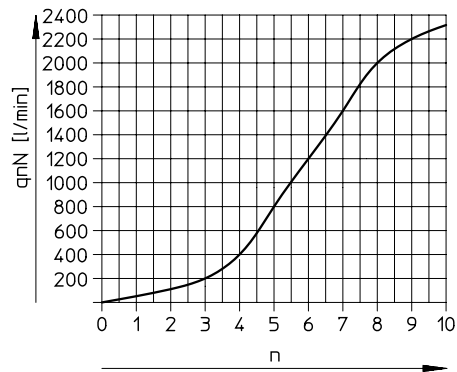

GRLA-1/2

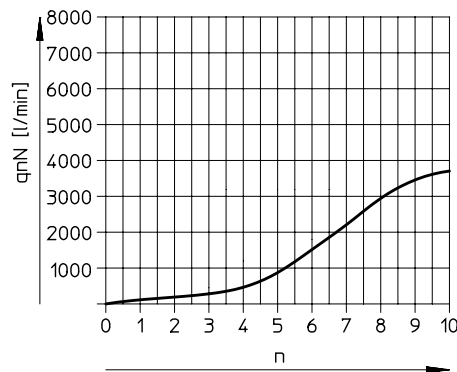

GRLA-3/4

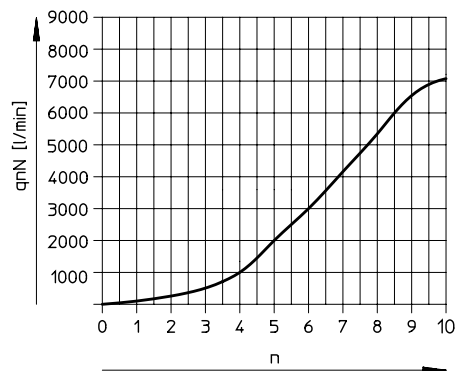

Materials

Sectional view

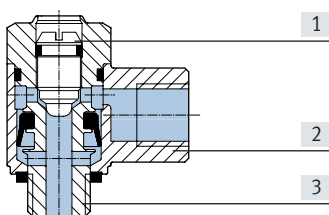

One-way flow control valve

[1]	Adjusting screw	Brass
[2]	Swivel joint	Die-cast zinc
[3]	Screwed trunnion	Wrought aluminium alloy GRLA/GRLZ-M5: Nickel-plated brass
–	Seals	NBR
Note on materials		RoHS-compliant
LABS (PWIS) conformity		VDMA24364-B1/B2-L

Datasheet – Female thread/barbed connector, metal

Dimensions – Connection type: Female thread

Download CAD data → www.festo.com

Slotted head screw

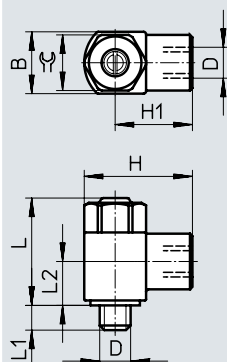

Knurled screw

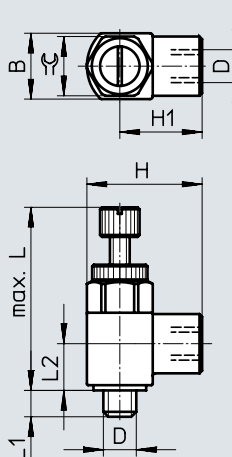

Type	Connection D	Nominal size [mm]	B	~H	~H1	~L		L1	~L2	⊕
						Slotted head screw	Knurled screw			
GRL...-M5	M5	2	10 -0.15	17.5	12.5	18 ±6.2%	28 ±3.4%	4.0 ±0.3	7.1	9
GRL...-1/8	G1/8	4	16 -0.15	28	20	26 ±3.9%	39.4 ±2.1%	5.3 +0.45/-0.35	10.3	14
GRL...-1/4	G1/4	6	20 -0.2	36	26	31.7 ±3.2%	47.4 ±2.0%	8.2 +0.45/-0.35	13.2	17
GRLA-3/8	G3/8	8.5	25 -0.2	41	28.5	38.5 ±2.9%	-	8.8 +0.45/-0.35	15.5	22
GRLA-1/2	G1/2	10.6	32 -0.2	53	37	50 ±2.4%	-	12.8 ±0.45	18.9	27
GRLA-3/4	G3/4	14	41 -0.3	64	43.5	61.8 ±2.2%	-	13.5 ±0.5	24.5	36

• Note: This product conforms to ISO 1179-1 and ISO 228-1.

Dimensions – Connection type: Barbed connector

Download CAD data → www.festo.com

GRL...-M5

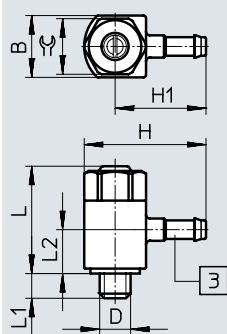

[3] Barbed connector

GRL...-1/8, GRL...-1/4

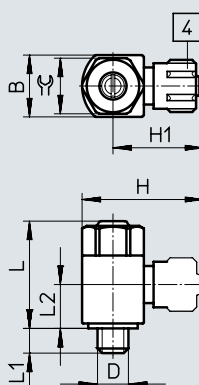

[4] Union nut

Type	Connection D	Nominal size [mm]	B	~H	~H1	~L		L1	~L2	⊕
GRL...-M5-PK-3	M5	2	10 -0.15	19.7	14.7	18	±5.7%	4.0 ±0.3	8.5	9
GRL...-M5-PK-4			10 -0.15	21.7	16.7	18	±5.7%	4.0 ±0.3	8.5	9
GRL...-1/8-PK-3	G1/8	4	16 -0.15	27.1	19.1	26	±3.9%	5.3 +0.45/-0.35	13.4	14
GRL...-1/8-PK-4			16 -0.15	30.2	22.2	26	±3.9%	5.3 +0.45/-0.35	13.4	14
GRL...-1/8-PK-6			16 -0.15	30.3	22.3	26	±3.9%	5.3 +0.45/-0.35	12.0	14
GRL...-1/4-PK-4	G1/4	6	20 -0.2	34.2	24.2	31.7	±3.3%	8.2 +0.45/-0.35	16.9	17
GRL...-1/4-PK-6			20 -0.2	34.3	24.3	31.7	±3.3%	8.2 +0.45/-0.35	17.2	17

Datasheet – Female thread/barbed connector, metal

Ordering data – Exhaust air one-way flow control function

Pneumatic connection	Standard nominal flow rate qnN At 6 → 5 bar		Standard flow rate qn At 6 → 0 bar		Weight [g]	Part no.	Type
	In flow control direction	In non-return direction	In flow control direction	In non-return direction			
	2	1	[l/min]	[l/min]			

Slotted head screw

	M5	M5	95	76 ... 95	169	135 ... 170	11	151160	GRLA-M5-B
	G1/8	G1/8	340	260 ... 420	615	470 ... 760	28	151165	GRLA-1/8-B
	G1/4 ²⁾	G1/4 ³⁾	610	450 ... 820	1200	885 ... 1615	59	151172	GRLA-1/4-B
	G3/8	G3/8	1450	970 ... 1600	2300	1540 ... 2540	97	151178	GRLA-3/8-B
	G1/2	G1/2	2100	1550 ... 2200	4000	2950 ... 4190	204	151179	GRLA-1/2-B
	G3/4	G3/4	4320	3220 ... 4720	7300	5440 ... 7300	377	151180	GRLA-3/4-B

	M5	PK-3	83	72 ... 83	140	120 ... 140	10	151161	GRLA-M5-PK-3-B
		PK-4	83	76 ... 88	140	128 ... 148	10	151162	GRLA-M5-PK-4-B
	G1/8	PK-3 ¹⁾	110	100 ... 110	162	145 ... 165	22	151166	GRLA-1/8-PK-3-B
		PK-4 ¹⁾	230	190 ... 240	360	295 ... 375	25	151167	GRLA-1/8-PK-4-B
		PK-6 ¹⁾	300	210 ... 290	455	320 ... 440	26	151168	GRLA-1/8-PK-6-B
	G1/4 ²⁾	PK-4 ⁴⁾	260	220 ... 260	370	315 ... 370	44	151173	GRLA-1/4-PK-4-B
		PK-6 ⁴⁾	540	410 ... 585	840	635 ... 910	45	151174	GRLA-1/4-PK-6-B

Knurled screw

	M5	M5	95	76 ... 95	169	135 ... 170	12	151163	GRLA-M5-RS-B
	G1/8	G1/8	340	260 ... 420	615	470 ... 760	30	151169	GRLA-1/8-RS-B
	G1/4 ²⁾	G1/4 ³⁾	610	450 ... 820	1200	885 ... 1615	59	151175	GRLA-1/4-RS-B

- 1) Via union nut
- 2) Male thread
- 3) Female thread
- 4) For barbed connector internal diameter with union nut

Ordering data – Supply air one-way flow control function

Pneumatic connection	Standard nominal flow rate qnN At 6 → 5 bar		Standard flow rate qn At 6 → 0 bar		Weight [g]	Part no.	Type
	In flow control direction	In non-return direction	In flow control direction	In non-return direction			
	2	1	[l/min]	[l/min]			

Slotted head screw

	M5	M5	95	76 ... 95	169	135 ... 170	11	151183	GRLZ-M5-B
	G1/8	G1/8	340	260 ... 420	615	470 ... 760	28	151188	GRLZ-1/8-B
	G1/4 ²⁾	G1/4 ³⁾	610	450 ... 820	1200	885 ... 1615	59	151195	GRLZ-1/4-B

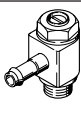
	M5	PK-3	83	72 ... 83	140	120 ... 140	10	151184	GRLZ-M5-PK-3-B
		PK-4	83	76 ... 88	140	125 ... 150	10	151185	GRLZ-M5-PK-4-B
	G1/8	PK-3 ¹⁾	110	100 ... 110	162	145 ... 165	22	151189	GRLZ-1/8-PK-3-B
		PK-4 ¹⁾	230	190 ... 240	360	295 ... 375	25	151190	GRLZ-1/8-PK-4-B
		PK-6 ¹⁾	300	210 ... 290	455	320 ... 440	26	151191	GRLZ-1/8-PK-6-B
	G1/4 ²⁾	PK-4 ⁴⁾	260	220 ... 260	370	315 ... 370	44	151196	GRLZ-1/4-PK-4-B
		PK-6 ⁴⁾	540	410 ... 585	840	635 ... 910	45	151197	GRLZ-1/4-PK-6-B

Knurled screw



	M5	M5	95	76 ... 95	169	135 ... 170	12	151186	GRLZ-M5-RS-B
	G1/8	G1/8	340	260 ... 420	615	470 ... 760	30	151192	GRLZ-1/8-RS-B
	G1/4 ²⁾	G1/4 ³⁾	610	450 ... 820	1200	885 ... 1615	59	151198	GRLZ-1/4-RS-B

- 1) Via union nut
- 2) Male thread
- 3) Female thread
- 4) For barbed connector internal diameter with union nut

Datasheet – Push-in connector QS, metal

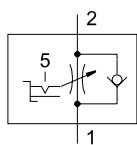
One-way flow control function
Exhaust air



-  - Flow rate
0 ... 450 l/min
-  - Temperature range
-10 ... +60°C
-  - Operating pressure
0.2 ... 10 bar



This one-way flow control valve provides the perfect conditions and a unique design for optimum and easy setting of the flow rate.

There are two setting options:

[1] Gradual for preselecting the flow rate range in 5 steps using a rotary switch:
A, B, C, D, E

[2] Infinitely variable for precision adjustment with a hex key using a scale marked from 0 to 10

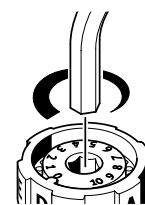
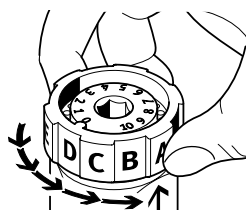
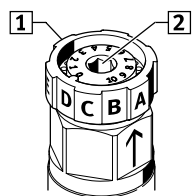

General technical data		
Pneumatic connection 2	G1/8	G1/4
Pneumatic connection 1	QS-6	QS-8
Valve function	Exhaust air one-way flow control function	
Adjusting element	Rotary knob with scale and hex socket	
Actuation type	Manual	
Type of mounting	Screw-in	
Mounting position	Any	
Nominal tightening torque [Nm]	3.5 ±20%	11 ±10%

Operating and environmental conditions		
Operating pressure for entire temperature range [bar]	0.2 ... 10	
Operating medium	Compressed air to ISO 8573-1:2010 [7:4:4]	
Note on the operating/pilot medium	Lubricated operation possible (in which case lubrication will always be required)	
Ambient temperature [°C]	-10 ... +60	
Temperature of medium [°C]	-10 ... +60	
Storage temperature [°C]	-10 ... +40	

Datasheet – Push-in connector QS, metal

Standard nominal flow rate q_{nN} at 6 → 5 bar as a function of the position of the flow control screw (scale) n

GRLSA-1/8

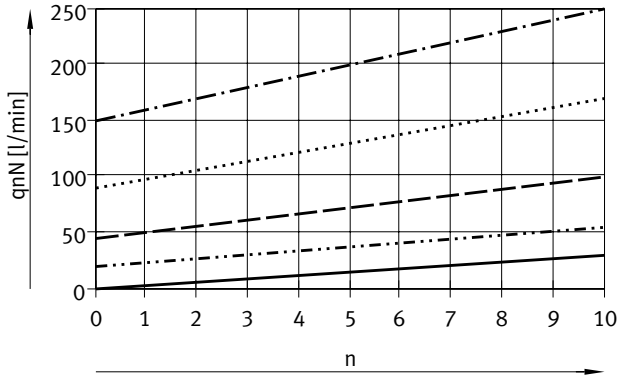

Standard flow rate q_n at 6 → 0 bar as a function of the position of the flow control screw (scale) n

GRLSA-1/8

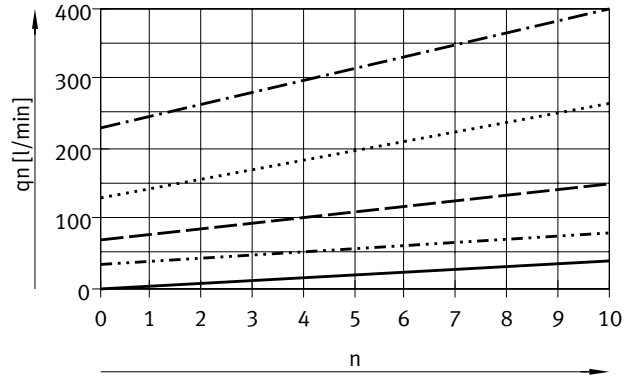

GRLSA-1/4

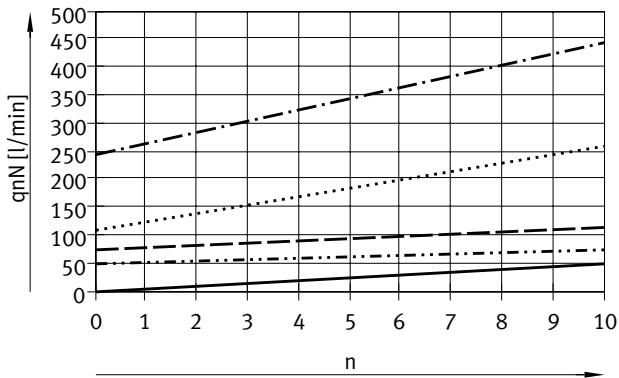

GRLSA-1/4

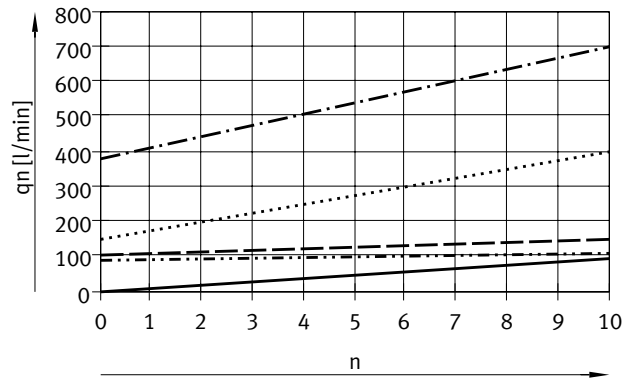

- Stage: A
 - · - · Stage: B
 - - - Stage: C
 - · · · · Stage: D
 - · - · - Stage: E
- Flow rate value tolerance: ±20%

Materials

Sectional view

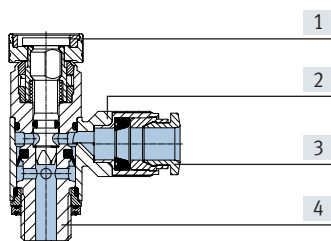

One-way flow control valve		
[1]	Adjusting screw	Reinforced PA
[2]	Swivel joint	Die-cast zinc
[3]	Releasing ring	POM
[4]	Hollow bolt	Anodised wrought aluminium alloy
-	Seals	NBR
Note on materials		RoHS-compliant
LABS (PWIS) conformity		VDMA24364-B2-L

Datasheet – Push-in connector QS, metal

Dimensions

Download CAD data → www.festo.com

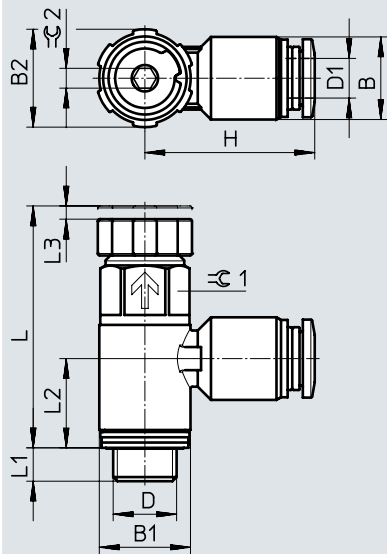

Type	Connection D	Tubing O.D. D1	B	B1	B2	H	L	L1	L2	L3	≙1	≙2
GRLSA-1/8	G1/8	6	12.5	13.8	15	25.7	36.6	5.1	13.5	2	12	3
GRLSA-1/4	G1/4	8	14.5	17.8	18.8	30.75	46.5	7	17.2	3	15	3

Ordering data

	Pneumatic connection		Standard nominal flow rate qnN At 6 → 5 bar		Standard flow rate qn At 6 → 0 bar		Weight [g]	Part no.	Type
			In flow control direction	In non-return direction	In flow control direction	In non-return direction			
			[l/min]	[l/min]	[l/min]	[l/min]			
	G1/8	QS-6	0 ... 250	180 ... 310	0 ... 410	430 ... 540	19.5	540661	GRLSA-1/8-QS-6
	G1/4	QS-8	0 ... 450	390 ... 570	0 ... 700	820 ... 930	34.8	540662	GRLSA-1/4-QS-8



Datasheet – Push-in connector QS, metal

One-way flow control function

Exhaust air

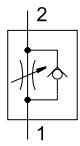
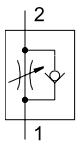
Supply air



-  - Flow rate
40 ... 48 l/min
-  - Temperature range
-10 ... +60°C
-  - Operating pressure
0.2 ... 10 bar

Low flow: precise adjustment
For low speed



General technical data – GRLA		
Pneumatic connection 2	M3	M5
Pneumatic connection 1	QS-3	QS-3, QS-4
Valve function	Exhaust air one-way flow control function	
Adjusting element	Slotted head screw	
Type of mounting	Screw-in	
Mounting position	Any	
Max. tightening torque [Nm]	0.3	1.5

General technical data – GRLZ		
Pneumatic connection 2	M3	M5
Pneumatic connection 1	QS-3	QS-3, QS-4
Valve function	Supply air one-way flow control function	
Adjusting element	Slotted head screw	
Type of mounting	Screw-in	
Mounting position	Any	
Max. tightening torque [Nm]	0.3	1.5

Operating and environmental conditions		
Operating pressure	[bar]	0.2 ... 10
	[psi]	2.9 ... 145
Operating medium	Compressed air to ISO 8573-1:2010 [7:4:4]	
Note on the operating/pilot medium	Lubricated operation possible (in which case lubrication will always be required)	
Ambient temperature [°C]	-10 ... +60	
Temperature of medium [°C]	-10 ... +60	
Storage temperature [°C]	-10 ... +40	
Maritime classification	GRLA: see certificate ¹⁾	

1) More information: www.festo.com/catalogue/grla → Support/Downloads

Datasheet – Push-in connector QS, metal

Standard nominal flow rate q_{nN} at 6 → 5 bar as a function of spindle rotations n

GRLA/GRLZ-M3

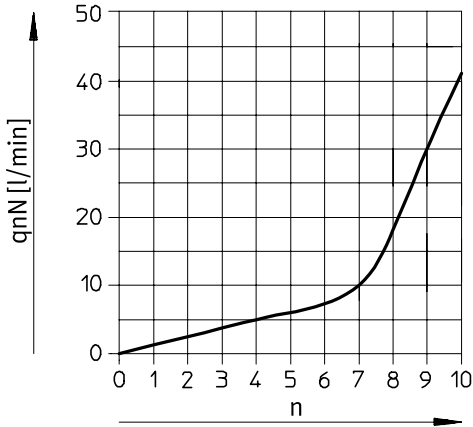

Standard flow rate q_n at 6 → 0 bar as a function of spindle rotations n

GRLA/GRLZ-M3

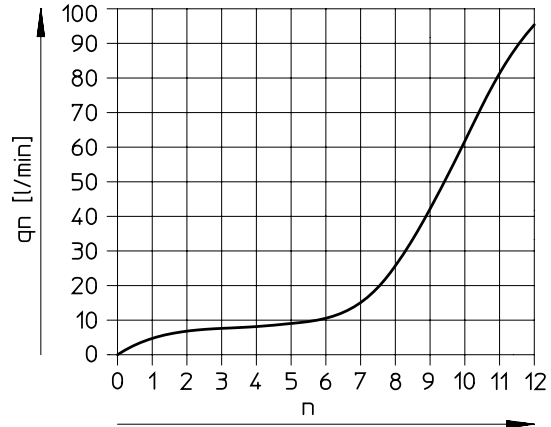

GRLA/GRLZ-M5

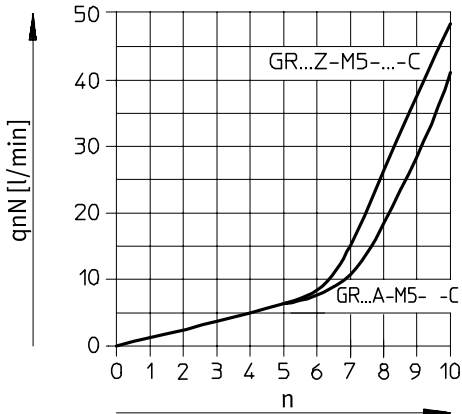

GRLA/GRLZ-M5

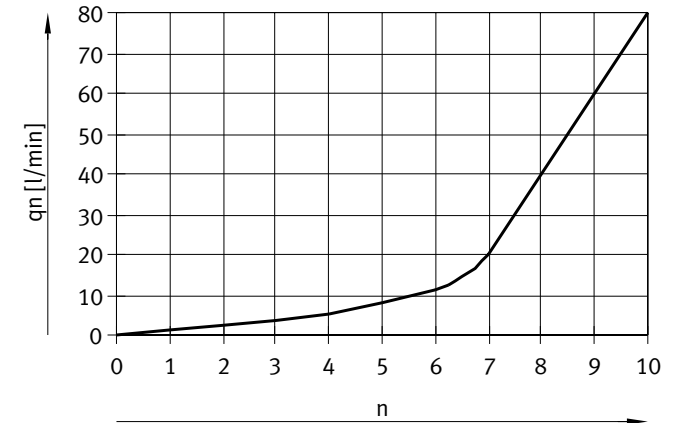

Materials

Sectional view

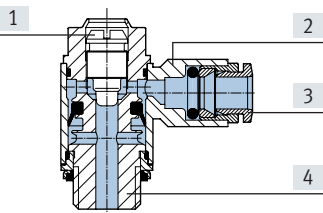

One-way flow control valve

[1]	Adjusting screw	Brass
[2]	Swivel joint	Die-cast zinc
[3]	Releasing ring	POM
[4]	Screwed trunnion	Brass, nickel-plated
-	Seals	NBR
Note on materials		RoHS-compliant
LABS (PWIS) conformity		VDMA24364-B1/B2-L

Datasheet – Push-in connector QS, metal

Dimensions

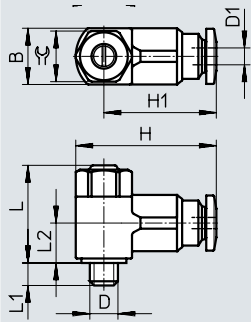
 Download CAD data → www.festo.com

Type	Connection D	Nominal size [mm]	Tubing O.D. D1	B	~H	~H1	~L	L1	~L2	≙
GRLA/GRLZ	M3	1.4	3	8-0.15	20	15.8	16.6 ±3.3%	2.3 +0.15/-0.3	7	7
	M5	1.4	3	9.8-0.15	22.4	18.4	17.2 ±3.1%	3.1 +0.15/-0.35	7.3	
		1.4	4	9.8-0.15	22.2	18.2	17.2 ±3.1%	3.1 +0.15/-0.35	7.3	

Ordering data

Pneumatic connection	Standard nominal flow rate qnN At 6 → 5 bar				Standard flow rate qn At 6 → 0 bar		Weight [g]	Part no.	Type		
	In flow control direction		In non-return direction		In flow control direction					In non-return direction	
	2	1	[l/min]	[l/min]	[l/min]	[l/min]				[l/min]	[l/min]

Exhaust air one-way flow control function

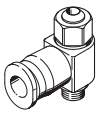
	M3	QS-3	41	27 ... 50	95	75 ... 110	7	175041	GRLA-M3-QS-3
	M5	QS-3	40	46 ... 70	80	90 ... 140	9	175053	GRLA-M5-QS-3-LF-C
		QS-4	40	50 ... 75	80	100 ... 150	9	175056	GRLA-M5-QS-4-LF-C

Supply air one-way flow control function

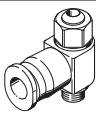
	M3	QS-3	41	27 ... 44	95	75 ... 100	7	175043	GRLZ-M3-QS-3
	M5	QS-3	48	36 ... 52	80	60 ... 90	9	175055	GRLZ-M5-QS-3-LF-C
		QS-4	48	40 ... 65	80	65 ... 110	9	175058	GRLZ-M5-QS-4-LF-C



Datasheet – Female thread, metal

One-way flow control function

Exhaust air

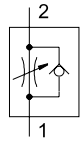
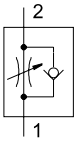
Supply air



-  - Flow rate
0 ... 18 l/min
-  - Temperature range
-10 ... +60°C
-  - Operating pressure
0.2 ... 10 bar



General technical data – GRLA		
Pneumatic connection 2		M3
Pneumatic connection 1		M3
Valve function	Exhaust air one-way flow control function	
Adjusting element	Slotted head screw	
Type of mounting	Screw-in	
Mounting position	Any	
Max. tightening torque	[Nm]	0.3

General technical data – GRLZ		
Pneumatic connection 2		M3
Pneumatic connection 1		M3
Valve function	Supply air one-way flow control function	
Adjusting element	Slotted head screw	
Type of mounting	Screw-in	
Mounting position	Any	
Max. tightening torque	[Nm]	0.3

Operating and environmental conditions		
Operating pressure	[bar]	0.2 ... 10
Operating medium	Compressed air to ISO 8573-1:2010 [7:4:4]	
Note on the operating/pilot medium	Lubricated operation possible (in which case lubrication will always be required)	
Ambient temperature	[°C]	-10 ... +60
Temperature of medium	[°C]	-10 ... +60
Storage temperature	[°C]	-10 ... +40
Maritime classification	GRLA: see certificate ¹⁾	

1) More information: www.festo.com/catalogue/grla → Support/Downloads

Standard nominal flow rate q_{nN} at 6 → 5 bar as a function of spindle rotations n

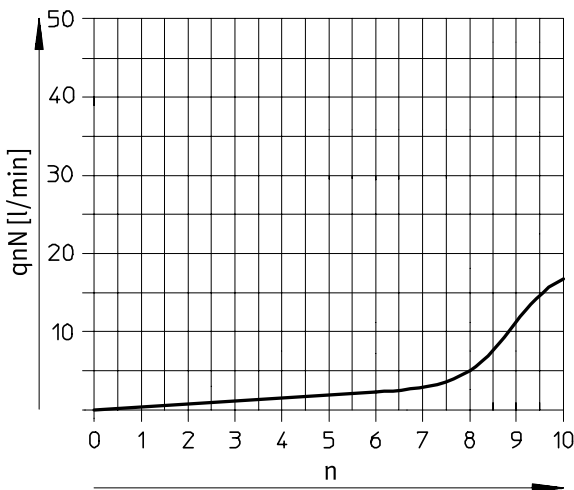

Standard flow rate q_n at 6 → 0 bar as a function of spindle rotations n

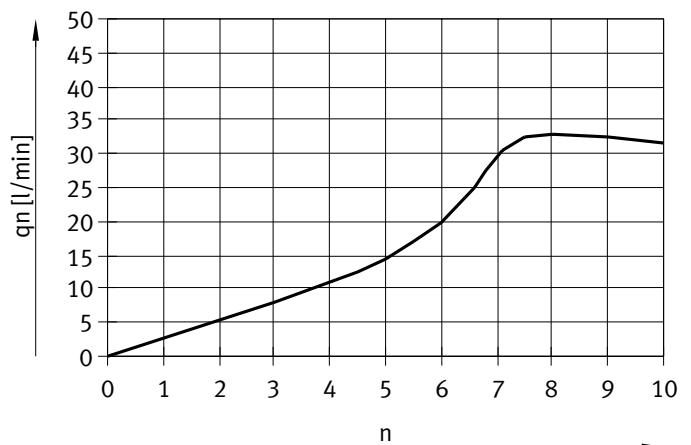

Datasheet – Female thread, metal

Materials

Sectional view

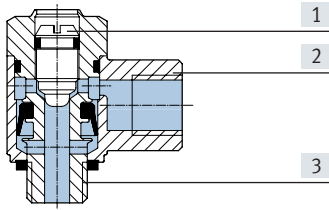

One-way flow control valve	
[1] Adjusting screw	Brass
[2] Swivel joint	Die-cast zinc
[3] Screwed trunnion	Brass, nickel-plated
– Seals	NBR
Note on materials	RoHS-compliant
LABS (PWIS) conformity	VDMA24364-B1/B2-L

Dimensions

Download CAD data → www.festo.com

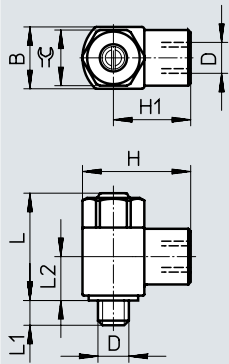

Type	Connection D	Nominal size [mm]	B	~H	~H1	~L	L1	~L2	≅
GRLA/GRLZ	M3	0.8	5 -0.1	9	6.5	13.4 ±3.9%	2.5 +0.15/-0.3	6.4	4.5

Ordering data

Pneumatic connection	Standard nominal flow rate qnN At 6 → 5 bar		Standard flow rate qn At 6 → 0 bar		Weight [g]	Part no.	Type
	In flow control direction	In non-return direction	In flow control direction	In non-return direction			
2 1	[l/min]	[l/min]	[l/min]	[l/min]			

Exhaust air one-way flow control function

	M3	M3	18	18 ... 20	33	33 ... 37	2	175038	GRLA-M3
--	----	----	----	-----------	----	-----------	---	--------	---------

Supply air one-way flow control function



	M3	M3	18	18 ... 20	33	33 ... 37	2	175040	GRLZ-M3
--	----	----	----	-----------	----	-----------	---	--------	---------

Datasheet – Female thread, stainless steel

One-way flow control function

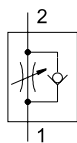
Exhaust air



-  Flow rate
95 ... 2100 l/min
-  Temperature range
-20 ... +80°C
-  Operating pressure
0.3 ... 10 bar



General technical data						
Pneumatic connection 2		M5	G1/8	G1/4	G3/8	G1/2
Pneumatic connection 1		M5	G1/8	G1/4	G3/8	G1/2
Valve function	Exhaust air one-way flow control function					
Adjusting element	Slotted head screw					
Actuation type	Manual					
Type of mounting	Screw-in					
Mounting position	Any					
Rotatability	360°/continuous rotation not permitted					
Max. tightening torque [Nm]		1.5	6	11	20	40
Permissible actuation torque, adjusting screw [Nm]		0.2	0.5	1.5	2	3

† Note: This product conforms to ISO 1179-1 and ISO 228-1.

Operating and environmental conditions						
Pneumatic connection 2		M5	G1/8	G1/4	G3/8	G1/2
Operating pressure	[MPa]	0.02 ... 1	0.03 ... 1			
	[bar]	0.2 ... 10	0.3 ... 10			
	[psi]	2.9 ... 145	4.35 ... 145			
Operating medium	Compressed air to ISO 8573-1:2010 [7:4:4]					
Note on the operating/pilot medium	Lubricated operation possible (in which case lubricated operation will always be required)					
Suitable for the production of lithium-ion batteries	Metals with more than 1% by mass of copper, zinc or nickel are excluded from use. Exceptions are nickel in steel, chemically nickel-plated surfaces, printed circuit boards, cables, electrical plug connectors and coils					
Cleanroom class	Element installed statically, no meaningful evaluation possible according to ISO 14644-1					
Ambient temperature [°C]	-20 ... +80					
Temperature of medium [°C]	-10 ... +60					
Storage temperature [°C]	-10 ... +40					
Corrosion resistance class CRC ¹⁾	3					
Food-safe	See supplementary material information ²⁾					
Maritime classification	See certificate ²⁾					

1) More information www.festo.com/x/topic/crc

2) More information: www.festo.com/catalogue/crgrla → Support/Downloads.

Datasheet – Female thread, stainless steel

Standard nominal flow rate q_{nN} at 6 → 5 bar as a function of spindle rotations n

CRGRLA-M5, CRGRLA-1/8

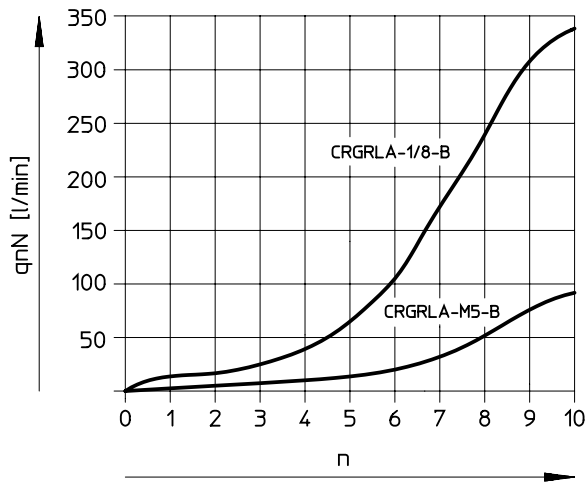

Standard flow rate q_n at 6 → 0 bar as a function of spindle rotations n

CRGRLA-M5, CRGRLA-1/8

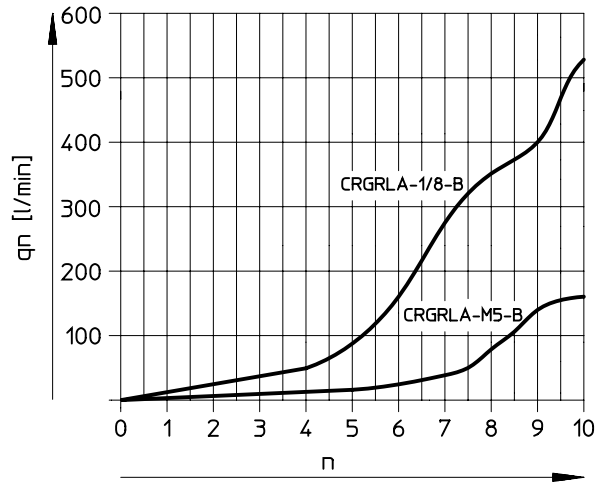

Standard nominal flow rate q_{nN} at 6 → 5 bar as a function of spindle rotations n

CRGRLA-1/4, CRGRLA-3/8, CRGRLA-1/2

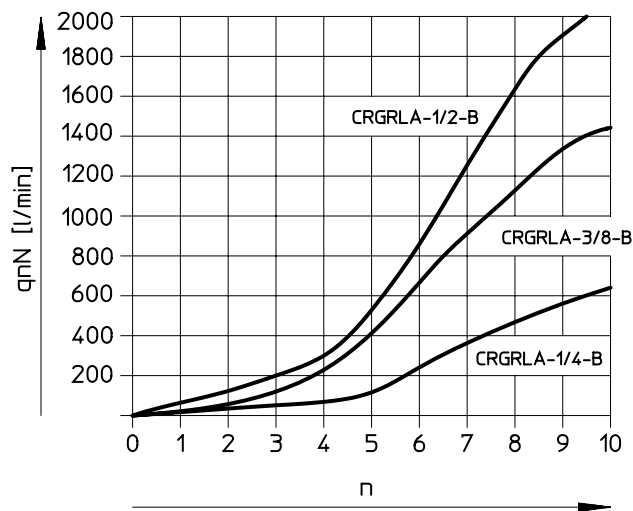

Standard flow rate q_n at 6 → 0 bar as a function of spindle rotations n

CRGRLA-1/4, CRGRLA-3/8, CRGRLA-1/2

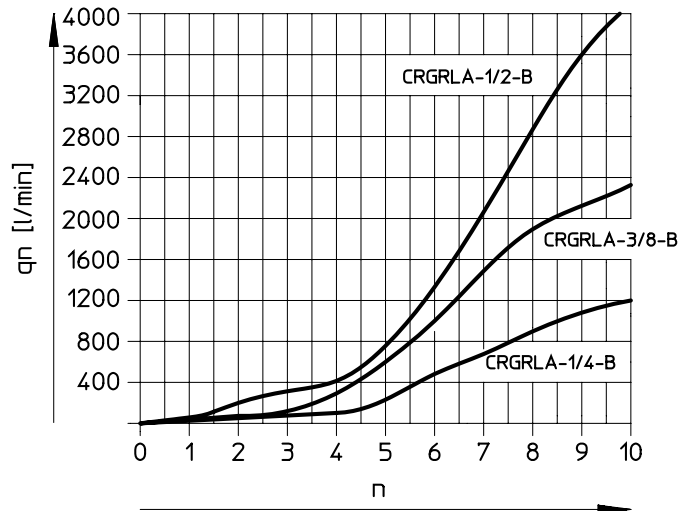

Materials

Sectional view

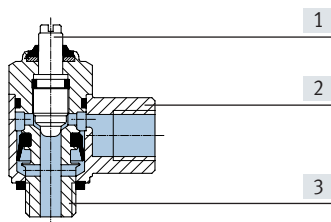

One-way flow control valve	
[1] Adjusting screw	High-alloy stainless steel
[2] Swivel joint	High-alloy stainless steel
[3] Hollow bolt	High-alloy steel
– Seals	FPM, PVC
Note on materials	RoHS-compliant
LABS (PWIS) conformity	VDMA24364-B2-L
Cleanroom class	Class 4 to ISO 14644-1

Datasheet – Female thread, stainless steel

Dimensions

Download CAD data → www.festo.com

CRGRLA-M5

CRGRLA-1/8, CRGRLA-1/4, CRGRLA-3/8, CRGRLA-1/2

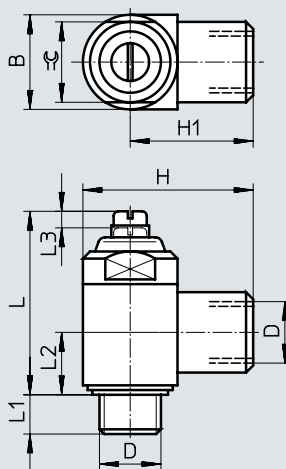
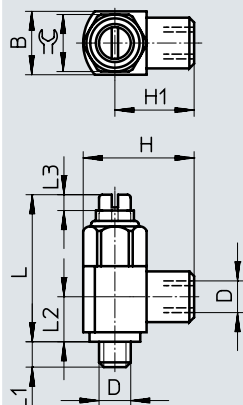

Type	Connection D	Nominal size [mm]	B	H	H1	-L	-L1	-L2	-L3	⌀
CRGRLA-M5	M5	2	10 -0.25	17.5 ±0.3	12.5	22.9 ±3.5%	4	7.1	2.5	9
CRGRLA-1/8	G1/8	4	16 -0.4	28 +0.4/-0.3	20	33.8 ±2.7%	5.5	10.3	3.5	14
CRGRLA-1/4	G1/4	6	20 -0.3	36 +0.4/-0.2	26	38.8 ±2.7%	6.5	13.2	3.5	17
CRGRLA-3/8	G3/8	8.5	25 -0.3	41 +0.4/-0.2	28.5	48.5 ±2.2%	7.5	15.4	5	22
CRGRLA-1/2	G1/2	10.6	32 -0.4	53 ±0.5	37	62.2 ±1.7%	9	18.9	7.5	27

† Note: This product conforms to ISO 1179-1 and ISO 228-1.

Ordering data

	Pneumatic connection		Standard nominal flow rate qnN At 6 → 5 bar		Standard flow rate qn At 6 → 0 bar		Weight [g]	Part no.	Type
			In flow control direction	In non-return direction	In flow control direction	In non-return direction			
	2	1	[l/min]	[l/min]	[l/min]	[l/min]			
	M5	M5	95	77 ... 95	165	140 ... 150	10.2	161403	CRGRLA-M5-B
	G1/8	G1/8	340	260 ... 420	580	530 ... 590	37.8	161404	CRGRLA-1/8-B
	G1/4	G1/4	610	450 ... 820	1265	1030 ... 1345	71.6	161405	CRGRLA-1/4-B
	G3/8	G3/8	1450	970 ... 1600	2515	2095 ... 2665	126.9	161406	CRGRLA-3/8-B
	G1/2	G1/2	2100	1550 ... 2200	4265	3550 ... 4325	262.3	161407	CRGRLA-1/2-B

Festo - Your Partner in Automation



1 Festo Inc.
5300 Explorer Drive
Mississauga, ON L4W 5G4
Canada

Festo Customer Interaction Center
Tel: 1 877 463 3786
Fax: 1 877 393 3786
Email: customer.service.ca@festo.com



2 Festo Pneumatic
Av. Ceylán 3,
Col. Tequesquináhuac
54020 Tlalnepantla,
Estado de México

Multinational Contact Center
01 800 337 8669
ventas.mexico@festo.com



3 Festo Corporation
1377 Motor Parkway
Suite 310
Islandia, NY 11749

Festo Customer Interaction Center
1 800 993 3786
1 800 963 3786
customer.service.us@festo.com



4 Regional Service Center
7777 Columbia Road
Mason, OH 45040

Connect with us



www.festo.com/socialmedia



www.festo.com

Subject to change