

Fieldbus Direct

FESTO



Key features



The system

- Extremely compact and space-saving design
- Low-cost solution for connecting of a small number of valves to a fieldbus
- Extremely safe, protection class up to IP65 depending on the series.

The Fieldbus Direct system comprises the following valve terminal series.

- CPV

The Fieldbus Direct product range is the most compact way of connecting valves to a fieldbus. The bus node is directly integrated in the electrical actuation of the valve terminal and therefore takes up only a minimal amount of space.

Fieldbus Direct is a system for connecting a valve terminal. The most important systems are covered.

The CP string extension option enables the functions and components of the CPI installation system to be used.

The optional string extension allows additional valve terminals and I/O modules to be connected to the bus node of the Fieldbus Direct system.

The I/O modules and cables for the CP string extension are ordered using the order code for the installation system CPI.

The maximum length of the CP string extension is 10 metres, which means that the extension modules can be mounted directly on site. All of the required electrical signals are transmitted via the CPI cable, which means that no further installation is needed on the extension module.

Valve terminal configurator online at: → www.festo.com

A valve terminal configurator is available online to help you select a suitable valve terminal.

Like all valve terminals, Fieldbus Direct is ordered using an ID code. This ID code specifies the valve functions, the number of valves, vacant positions as

well as the additional functions and the type of compressed air supply. As is the case with all Festo products, all valve terminals are supplied:

- Fully pre-assembled
- Equipped with fittings on request

- Tested for electrical function
- Tested for pneumatic function
- Securely packaged
- User documentation can be downloaded free of charge

Key features

Switch module for CPV Direct

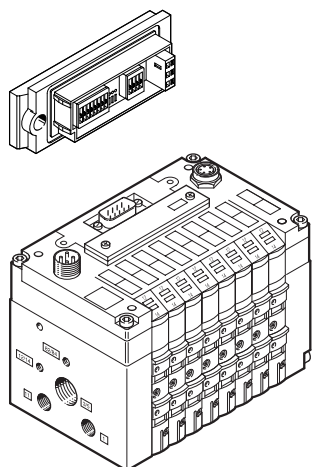

The bus parameters and the device configuration for the CPV Direct are set using the removable switch module.

The integrated DIL switches are easy to set and control even if the installation location is difficult to access.

In the case of valve terminals with the CP system to specification "B", the DIL switches are integrated into the basic unit of the electric for parameterisation and configuration.

CP string extension

The optional string extension allows an additional valve terminal and I/O modules to be connected to the Fieldbus Direct bus node. A CP string of the CP installation system is integrated in the bus node as an extension. Different input and output modules as well as CPV, MPA-S, CPV-SC valve terminals can be connected.

The maximum length of the CP string extension is 10 metres, which means that the extension modules can be mounted directly on site. All the required electrical signals are transmitted via the CP cable, which in turn means that no further installation is needed on the extension module.

The CP string interface offers:

- 16 input signals
- 16 output signals for output modules 24 V DC or solenoid coils
- Logic and sensor supply for the input modules
- Load voltage supply for the valve terminals
- Logic supply for the output module

In the variant to specification "B",

- 32 inputs
 - 32 outputs 24 V DC or solenoid coils can be connected.
- The CP modules without specification "B" can of course also be connected to valve terminals CPI string extension.

CPV Direct with bus node

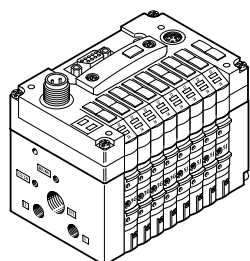

- 8 valve slices
- 16 solenoid coils
- 16 3/2-way valves

CPV Direct with input module for sensing cylinder end positions

- 8 valve slices with up to 16 solenoid coils
- 16 inputs M8 or M12, each with sensor supply

Variant according to specification "B"

- 32 input signals
- 32 output signals/solenoid coils

Key features – Bus connection

Fieldbus Direct system diagnostics

The bus node together with the modules connected to the CP string offer a range of diagnostics options.

Diagnostic LEDs on the Fieldbus Direct node

The fieldbus-specific LEDs indicate the communication status and the fieldbus function.

Further LEDs indicate the power supply status of all connected modules as a common message.

- Undervoltage
- Short circuit
- Interruption of voltage

Diagnostic LEDs on the CP extension modules

The current status of the switching signals of the inputs or outputs are indicated by LEDs directly on the individual CP/CPI modules. Short circuit or overload of the power supply and communication faults on the CP connection are indicated via additional LEDs.

Diagnostic messages via the fieldbus

The CP connection is used for transmitting all available diagnostics information to the bus node. The complete device diagnostics can then be transmitted to the fieldbus master.

- Configuration error
- Short circuit/overload of an output module
- Short circuit/undervoltage of the sensor supply
- Undervoltage/load voltage of the valves
- CP string interruption to one of the CP modules

Valve terminals with CP interface

Valve terminal CPV

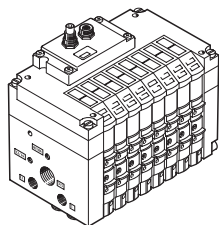

CPV10
CPV14
CPV18

- Max. 16 valves in 8 valve slices
- Highly compact and space-saving
- Width 10, 14, 18 mm
- Nominal flow rate 400/800/1600 l/min
- CPV10, CPV14 and CPV18 with CPI functionality

More information
→ Internet: cpv

MPA-S valve terminal

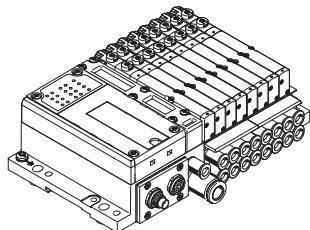

MPA1
MPA2

- Max. 32 valves
- Modular and versatile
- Width 10, 20 mm
- Nominal flow rate 360/700 l/min
- CPI functionality

More information
→ Internet: mpa-s

Peripherals overview

Input/output modules CP/CPI installation system

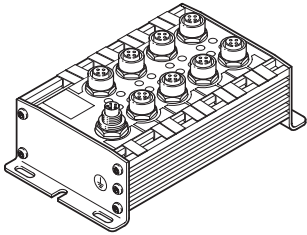

CP-E16-M12x2-5POL

- 16 inputs 24 V DC
- Signal status indication via 16 LEDs
- Operating status indication
- M12 socket, double allocation
- 1x M9 CP/CPI connection
- PNP/NPN, IP65

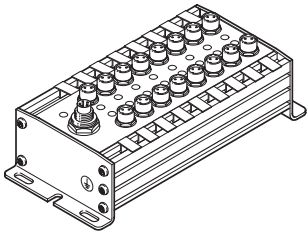

CP-E16-M8

- 16 inputs 24 V DC
- Signal status indication via 16 LEDs
- Operating status indication
- M8 socket, single allocation
- 1x M9 CP connection
- PNP/NPN, IP65

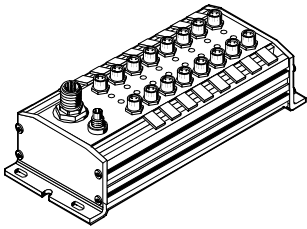

CP-E16-M8-Z

- 16 inputs 24 V DC
- Signal status indication via 16 LEDs
- Operating status indication
- Galvanic isolation through additional power supply
- M8 socket, single allocation
- 1x M9 CP connection
- Separate sensor supply
- PNP/NPN, IP65

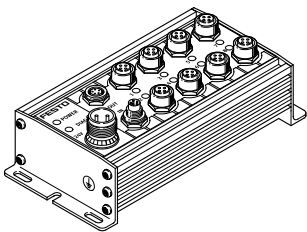

CP-A08-M12-5POL

- 8 outputs 24 V DC
- Output signal indication via 8 LEDs
- Operating status indication
- M12 socket, single allocation
- 2x M9 CP connection
- Separate load voltage
- Outputs resistant to overloads and short circuits
- PNP/NPN, IP65

Detailed description of input and output modules
 → Internet: ctec

Peripherals overview

Input/output modules CP/CPI Compact Line

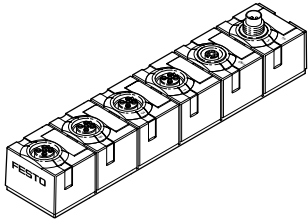

CP-E08-M12x2-CL

- 8 inputs 24 V DC
- Signal status indication via 8 LEDs
- Operating status indication
- 4 x M12 socket, 5-pin, double allocation
- 2x M9 CP connection
- PNP, IP65/67

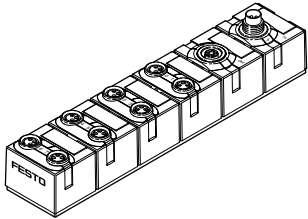

CP-E08-M8-CL

- 8 inputs 24 V DC
- Signal status indication via 8 LEDs
- Operating status indication
- 8x M8 socket, 3-pin, single allocation
- 2x M9 CP connection
- PNP, IP65/67

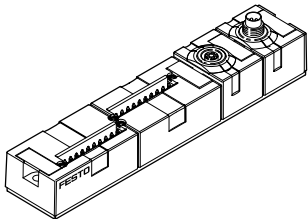

CP-E16-KL-CL

- 16 inputs 24 V DC
- Indirect signal status indication via LEDs in the connection set of the tension-spring socket
- Operating status indication
- Screw terminal or tension-spring sockets
- 2x M9 CP connection
- PNP, IP20

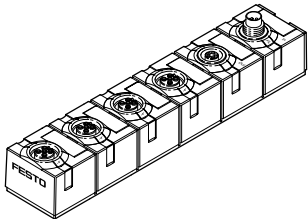

CP-A04-M12x2-CL

- 4 outputs 24 V DC
- Signal status indication via 4 LEDs
- Operating status indication
- 4 x M12 socket, 5-pin, double allocation
- 2x M9 CP connection
- Outputs resistant to overloads and short circuits
- PNP, IP65/67

Detailed description of input and output modules
 → Internet: ctec

Peripherals overview

Input/output modules CP/CPI Eco Line

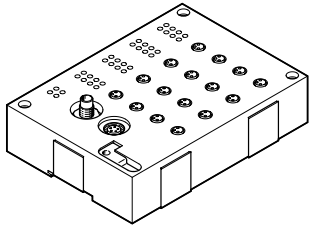

CP-E16-M8-EL

- 16 inputs 24 V DC
- Signal status indication via LEDs
- Operating status indication

- 16 x M8 socket, 3-pin, double allocation
- 2x M9 CP connection
- PNP

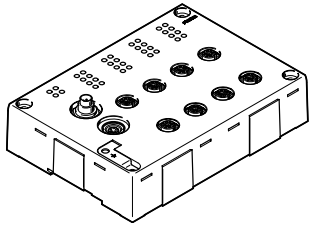

CP-E16-M12-EL

- 16 inputs 24 V DC
- Signal status indication via LEDs
- Operating status indication

- 8x M8 socket, 5-pin, single allocation
- 2x M9 CP connection
- PNP

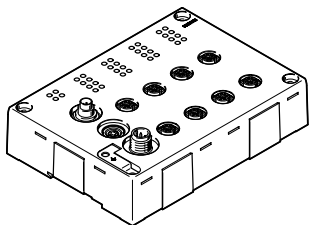

CP-A08-M12-EL-Z

- 8 outputs 24 V DC
- Signal status indication via LEDs
- Operating status indication

- 4 x M12 socket, 5-pin, double allocation
- 2x M9 CP connection
- Outputs resistant to overloads and short circuits
- PNP

Detailed description of input and output modules
 → Internet: ctec

CP connecting cable

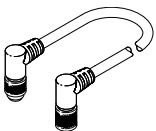

The CP string is connected using pre-assembled CP cables supplied in lengths of 0.5 to 8 metres.

Peripherals overview

Fieldbus systems for CPV Direct

Fieldbus variants:

Of more than 20 different fieldbus systems (protocols) on the market, a few have emerged as significant. Festo supports these with a range of bus nodes (FBxx) on the valve terminals. Fieldbus systems require a powerful central PLC and a master interface for each fieldbus.

Fieldbus systems are preferably used when it is necessary to control multiple devices that have many inputs/outputs, complex functions or highly complex communication. In this case, the benefits of simple cabling and convenient diagnostics and servicing outweigh the additional complexity of a fieldbus master interface and the know-how required.

Festo fieldbus

A fieldbus developed by Festo that offers simple user guidance and is supported by the controllers of the FPC, SF and IPC series (Festo FB5). A maximum of 98 bus stations can be connected to the Festo fieldbus. The bus can be operated with 4 different baud rates. 31.25, 62.5, 187.75 and 375 kbps.

PROFIBUS DP

An open fieldbus standard originally developed by Siemens and now in use worldwide. The bus can be operated with baud rates from 9.6 kBd to 12 MBd.

DeviceNet

Open fieldbus standard based on CAN technology, which was originally developed for the automotive sector. DeviceNet was originally developed by Rockwell (Allen Bradley) and is now an open standard.

Moeller SUCONET K

A maximum of 98 bus stations can be connected to the SUCONET K fieldbus. Depending on the project design, bus length etc, the bus can be operated at a baud rate of 187.5 or 375 kbps. The bus interface is based on RS 485 with a master/slave structure.

ABB CS31

The fieldbus from ABB connects a maximum of 63 fieldbus stations with the fieldbus master. The data is transmitted at a constant baud rate of 187.5 kbps. The protocol is suitable for use in the entire range of automation technology

Key features – Electrical connection

Operating voltage and load current supply

The operating voltages for the Fieldbus Direct valve terminal and for the extension modules are connected centrally via the 4- or 5-pin M12 plug.

The operating voltages are required for the bus node electronics and the modules connected to the CP string.

The load supply for the valves is supplied separately from the supply for the electronic unit.

The valves of the Fieldbus Direct valve terminals and the valves/outputs on the CP string extension are supplied together via pin 2 of the M12 plug.

The power supply for the connected input module sensors are normally also

supplied via the M12 plug. Up to 500 mA for the sensor supply to the connected input module is provided via the CP string.

A separate, galvanically isolated sensor supply is provided for the input modules CP-E16-KL-IP20-Z and CP-E16-M8-Z. A max. current of 2 A is available to the sensors here.

Since, in addition to communication, the entire power supply to the connected modules is routed via the CP string, this offers a very installation-friendly option for extension.

The following functions are supported via the CP string:

- Connection for data exchange
- Power supply for the connected modules
- Sensor voltage supply of up to 500 mA
- Load voltage supply for the connected valves

The electrical modules are protected against overload with electronic fuses. All the diagnostics are transmitted to the bus node via the CP string, where it is forwarded to the PLC according to the specific protocol.

Circuitry example for CPV Direct – Connection of load voltage

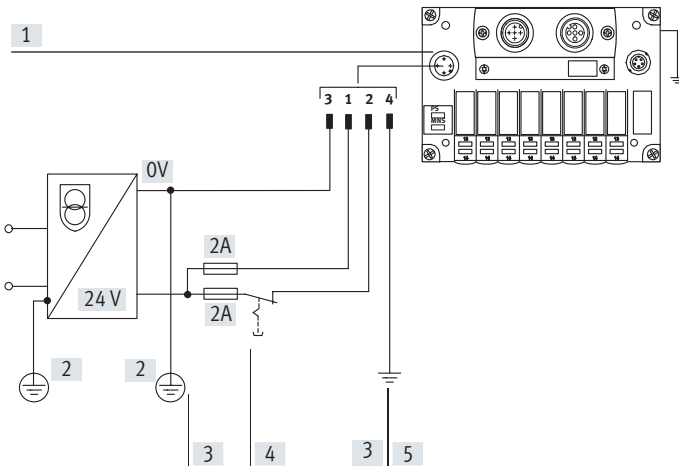

- [1] Connection for power supply on the CPV Direct valve terminal
- [2] Protective earthing (PE)
- [3] Equipotential bonding
- [4] Load voltage can be switched off separately and external fuse
- [5] Earth terminal on pin 4, configured for 3 A

Pin allocation – Power supply for CPV Direct

	Pin	Designation	Information
	1	24 V DC electronics and sensors	The voltage is supplied via a 4-pin M12 plug (A-coded).
	2	24 V DC valves and outputs	
	3	0 V electronics and sensors	
	4	Earth terminal	

Datasheet – Bus node CPV-DI01



CPV bus node for communication between a CPV valve terminal and a fieldbus master. It controls a CPV valve terminal with 8 valve slices and 16 solenoid coils and their signal status indication via LED. The valves CPV... are controlled by an automatic current reduction, which reduces the energy demand and heat output. 16 digital inputs and 8 digital outputs or 16 valves can be connected via a serial CP string extension.

DIO1 supports 4 different fieldbus protocols, which are selected using DIL switches:

- PROFIBUS DP
- Moeller SUCOnet K
- ABB CS31
- Festo fieldbus

The CPV bus node is available in three sizes with identical features:

- CPV10
- CPV14



Application

Bus connection

Sub-D socket

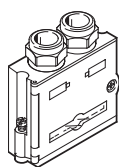

M12 adapter

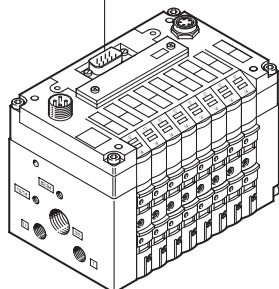
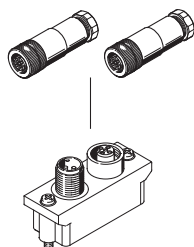

Sub-D socket

- 9-pin Sub-D socket
- Installation with IP65 protection

The bus connection is established via a 9 pin Sub-D socket with a typical PROFIBUS allocation (to EN 50 170). The bus connector plug (with protection class IP65 from Festo or IP20 from other manufacturers) facilitates the connection of an incoming and an outgoing bus cable. An active bus terminal can be connected using the integrated DIL switch. The Sub-D interface is designed for activating network components via a fibre optic cable connection.

M12 adapter

- Plug connector 2xM12
- Installation with IP65 protection

Alternatively, the bus connection can be established via a 2xM12 adapter (B-coded).

Datasheet – Bus node CPV-DI01

General technical data			CPV10-GE-DI01-8	CPV14-GE-DI01-8
Type				
Fieldbus interface			Either <ul style="list-style-type: none"> • Sub-D, 9-pin, socket • Socket and plug, M12x1, 5-pin, B-coded 	
Electrical isolation of fieldbus interface			Via optocoupler	
Baud rate	[kbps]		9.6 ... 12000, automatic detection	
Addressing range	PROFIBUS DP (12 MBd) Festo fieldbus ABB CS31 Moeller SUKONET K		1 ... 125, Set using switch module	
CP/CPI string extension			Yes, 16 inputs and 8 outputs (or 16 valves)	
LED indication (bus-specific)	BUS		Communication and configuration errors	
LED indicator	Product-specific		Signal status of valves	
	Power		Operating voltage for electrics and load supply	
Product identification			Product family 4: Valves	
ID number			0xC9	
Communication type			Cyclic communication	
Configuration support			GSD file and bitmaps	
Max. number of solenoid coils			16	
Max. no. of solenoid coils with string extension			32	
Max. no. of outputs			8 (1x16 solenoid coils not required)	
Max. no. of inputs			16	
Device-specific diagnostics			<ul style="list-style-type: none"> • Short circuit/overload, outputs • Undervoltage of valves • Undervoltage of outputs • Undervoltage of sensor supply • Module missing on CP/CPI string extension • Via device-specific diagnostics (DVPO) 	
Operating voltage	Nominal value	[V DC]	24, reverse polarity protected	
	Permissible range	[V]	20.4 ... 26.4	
	Residual ripple	[Vss]	4	
	Power failure buffering	[ms]	10	
Current consumption			Max.100 + sensor supply	
Degree of protection to EN 60529			IP65	
Materials	Housing		Die-cast aluminium	
	Cover		Reinforced polyamide	
	Seal		Nitrile rubber	
Product weight	[g]	240	351	
Dimensions			→ Internet: cpv	
Technical data – Valves				
Operating and environmental conditions				
Ambient temperature	[°C]	-5 ... +50		
Storage temperature	[°C]	-20 ... +70		
Fieldbus certification			PNO	
Certification			c UL us - Recognized (OL)	
CE marking (see declaration of conformity)			To EU EMC directive	
Note on materials			RoHS-compliant	

Datasheet – Bus node CPV-DI01

Connection and indicator components

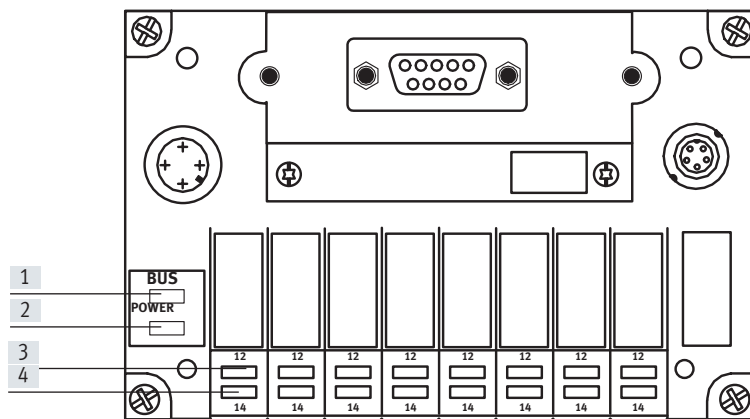

- [1] Red LED: Bus status/fault (BUS)
- [2] Green LED: Power supply (POWER)
- [3] Yellow row of LEDs: for pilot solenoid coils 12
- [4] Yellow row of LEDs: for pilot solenoid coils 14



Pin allocation for fieldbus interface (view of plug)

	Pin	Festo Sub-D plug (IP65)	Manufacturer-specific signal designation				
			Festo fieldbus interface	ABB CS31	PROFIBUS DP	Moeller SUCONET K	
						Sub-D 9-pin	DIN (round) 5-pin
	1	–	–	–	n.c.	–	–
	2	–	–	–	n.c.	–	–
	3	B	S+	Bus1	RxD/TxD-P	3 (T _A /R _A)	4 (T _A /R _A)
	4	–	–	–	CNTR-P	–	–
	5	–	–	–	DGND	–	–
	6	–	–	–	VP	–	–
	7	–	–	–	n.c.	–	–
	8	A	S-	Bus2	RxD/TxD-N	7 (T _B /R _B)	1 (T _B /R _B)
	9	–	–	–	n.c.	–	–
Housing	Cable clip	Shielding	Shield	Shielding	4 (shielding)	Housing	

Pin allocation for M12 adapter

	Bus In (Pin)	Bus Out (Socket)	PROFIBUS DP (Signal)	Designation
	M12 and 5	M12 and 5	Shield	Shielding or functional earth
	4	4	RxD / TxD-P	Line B
	–	3	DGND	Reference potential to supply voltage positive (VP)
	–	1	VP (P5V)	Supply voltage positive
	2	2	RxD / TxD-N	Line A

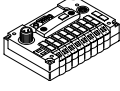
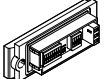
Accessories – Bus node CPV-DI01

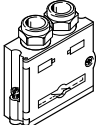
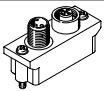
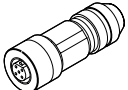
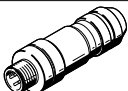
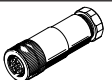
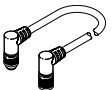
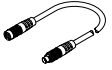
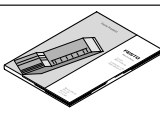
Ordering data		Part no.	Type
Designation			
Bus node			
	CPV10	165809	CPV10-GE-DI01-8
	CPV14	165811	CPV14-GE-DI01-8
Switch module			
	For setting bus parameters and device configuration for the CPV	165814	CPV1 0/14/18-GE-DI-SM
Power supply			
	Power supply socket, straight, M12x1, 4-pin	For cable \varnothing 4 ... 6 mm	18494 SIE-GD
		For cable \varnothing 8 ... 9.5 mm	18495 FBSD-GD-9
	Power supply socket, angled, M12x1, 4-pin	For cable \varnothing 4 ... 6 mm	12956 SIE-WD-TR
		For cable \varnothing 6 ... 8 mm	18525 FBSD-WD-9
Fieldbus interface			
	Fieldbus socket, Sub-D connection	532216	FBS-SUB-9-GS-DP-B
Bus connection micro style M12			
	Micro style bus connection, 2xM12	533118	FBA-2-M12-5POL-RK
	Socket M12x1, 5-pin, straight For self-assembly of a connecting cable for FBA-2-M12-5POL-RK	1067905	NECU-M-B12G5-C2-PB
	Plug M12x1, 5-pin, straight For self-assembly of a connecting cable for FBA-2-M12-5POL-RK	1066354	NECU-M-S-B12G5-C2-PB
	Fieldbus socket for micro style connection, M12, 5-pin, straight	18324	FBSD-GD-9-5POL
	Plug for micro style connection, M12, 5-pin, straight	175380	FBS-M12-5GS-PG9
Valve terminal connection			
	Connecting cable, angled plug, angled socket	0.25 m	540327 KVI-CP-3-WS-WD-0.25
		0.5 m	540328 KVI-CP-3-WS-WD-0.5
		2 m	540329 KVI-CP-3-WS-WD-2
		5 m	540330 KVI-CP-3-WS-WD-5
		8 m	540331 KVI-CP-3-WS-WD-8
	Connecting cable, straight plug, straight socket	2 m	540332 KVI-CP-3-GS-GD-2
		5 m	540333 KVI-CP-3-GS-GD-5
		8 m	540334 KVI-CP-3-GS-GD-8
User documentation			
	User documentation for CPV Direct, CPV bus node DI01	German	165816 P.BE-CP-DI01-DE
		English	165817 P.BE-CP-DI01-DE
		Italian	165818 P.BE-CP-DI01-IT
		French	165819 P.BE-CP-DI01-FR
		Spanish	165820 P.BE-CP-DI01-ES

Datasheet – Bus node CPV-DI02-8



CPV bus node according to the CP system with specification "B" for communication between a CPV valve terminal and a fieldbus master. It controls a CPV valve terminal with 8 valve slices and 16 solenoid coils and their signal status indication via LED. The valves CPV-... are controlled by an automatic current reduction, which reduces the energy demand and heat output. 32 digital inputs and 32 digital outputs or 32 solenoid coils can be connected via a serial CP string extension.



The CPV bus node is available in three sizes with identical features:

- CPV10
- CPV14

Application

Bus connection

Sub-D socket

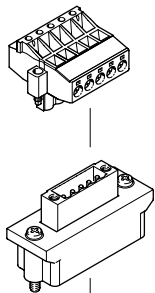

M12 adapter

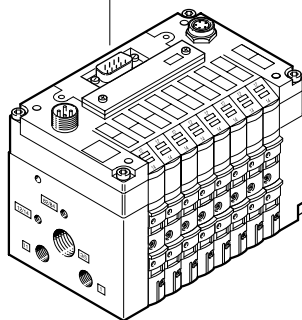
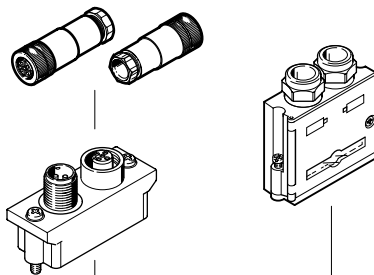

Sub-D socket

- 9-pin Sub-D socket
- Installation with IP65 protection

The bus connection is established via a 9 pin Sub-D socket with a typical PROFIBUS allocation (to EN50170). The bus connector plug (with protection class IP65 from Festo or IP20 from other manufacturers) facilitates the connection of an incoming and an outgoing bus cable. An active bus terminal can be connected using the integrated DIL switch. The Sub-D interface is designed for activating network components via a fibre optic cable connection.

M12 adapter

- Plug connector 2xM12
- Installation with IP65 protection

Alternatively, the bus connection can be established via a 2xM12 adapter (A-coded).

Screw terminals

5-pin screw terminal strip for installation in protected environments (IP20). The bus connection is established via a 5-pin row. If the valve terminal is ordered with this bus connection, the 5-pin screw terminal strip is supplied with it. It is designed with dual screw terminals for the incoming and outgoing bus cables. This connection technology provides a T-distributor function.

Datasheet – Bus node CPV-DI02-8

General technical data			CPV10-GE-DI02-8	CPV14-GE-DI02-8
Type				
Fieldbus interface	Either		<ul style="list-style-type: none"> Screw terminal strip, 5-pin Sub-D, 9-pin, socket Socket and plug, M12x1, 5-pin, B-coded 	
Electrical isolation of the fieldbus interface			Optocoupler	
CP string extension			Yes, 32 inputs and 32 outputs	
Baud rate		[kbps]	9.6 ... 12 000, Automatic detection	
Addressing range	PROFIBUS DP (12 MBd)		1 ... 125 Set using switch module	
LED indicator	Bus-specific		Communication and configuration errors	
LED indicator	Product-specific		Signal status of valves	
	Power		Operating voltage for electrics and load supply	
ID number			0xC9	
Communication type			Cyclic communication	
Configuration support			GSD file and bitmaps	
Max. number of solenoid coils			16	
Max. no. of solenoid coils with string extension			48	
Max. no. of outputs			16 solenoid coils and 32 outputs	
Max. no. of inputs			32	
LED diagnostic indication	POWER		Operating voltage for electronics and load supply	
	BUS		Communication and configuration errors	
Device-specific diagnostics			<ul style="list-style-type: none"> Short circuit/overload, outputs Undervoltage of valves Undervoltage of outputs Undervoltage of sensor supply Module missing on CP/CPI string extension Via device-specific diagnostics (DPVO) 	
Operating voltage	Nominal value	[V DC]	24, reverse polarity protected	
	Permissible range	[V]	20.4 ... 26.4	
	Residual ripple	[Vss]	4	
	Power failure buffering	[ms]	10	
Current consumption		[mA]	Max.100 + sensor supply	
Degree of protection to EN 60529			<ul style="list-style-type: none"> IP20 with 5-pin screw terminal strip IP65 Sub-D, socket/plug M12x1 	
Materials	Housing		Die-cast aluminium	
	Cover		Reinforced polyamide	
	Seals		Nitrile rubber, polychloroprene rubber	
Product weight		[g]	196	310
Dimensions			→ Internet: cpv	
Technical data – Valves				

Operating and environmental conditions		
Ambient temperature	[°C]	-5 ... +50
Storage temperature	[°C]	-20 ... +70
Fieldbus certification		PNO
Certification		c UL us - Recognized (OL)
CE marking (see declaration of conformity)		To EU EMC Directive
Note on materials		RoHS-compliant

Datasheet – Bus node CPV-DI02-8

Connection and indicator components

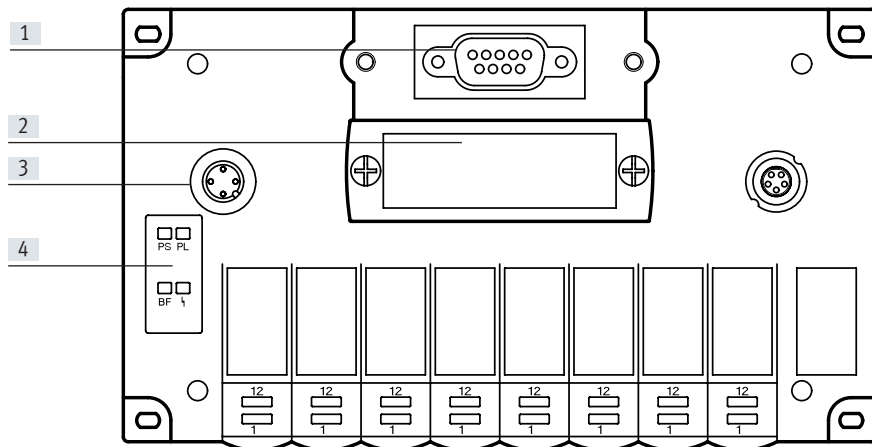

- [1] Fieldbus interface (9-pin Sub-D socket)
- [2] Removable switch cover
- [3] Operating/load voltage connection (4-pin M12 plug)
- [4] Power LEDs PS, PL and bus status LEDs BF





Pin allocation for PROFIBUS-DP interface (plug view)

	Pin	Signal	Designation
	1	n.c.	Not connected
	2	n.c.	Not connected
	3	RxD/TxD-P	Received/transmitted data P
	4	CNTR-P	Repeater control signal
	5	DGND	Data reference potential (M5V)
	6	VP	Supply voltage positive (P5V)
	7	n.c.	Not connected
	8	RxD/TxD-N	Received/transmitted data N
	9	n.c.	Not connected
	Housing	Shielding	Connection to functional earth

Pin allocation for M12 adapter

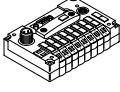
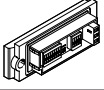
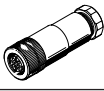
	Pin	Signal	Designation
	1	VP	Supply voltage positive (P5V)
	2	RxD/TxD-N	Received/transmitted data N
	3	DGND	Data reference potential (M5V)
	4	RxD/TxD-P	Received/transmitted data P
	5	FE	Functional earth

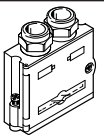
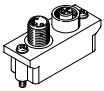
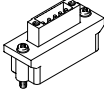
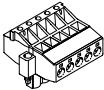
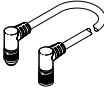
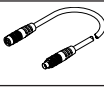
Accessories – Bus node CPV-DI02-8

Ordering data		Part no.	Type
Designation			
Bus node			
	CPV10	546188	CPV10-GEDI02-8
	CPV14	546190	CPV14-GEDI02-8
Switch module			
	For setting bus parameters and device configuration for the CPV	165814	CPV10/14/18-GE-DI-SM
Power supply			
	Power supply socket, straight, M12x1, 4-pin	For cable \varnothing 4 ... 6 mm	18494 SIE-GD
		For cable \varnothing 8 ... 9.5 mm	18495 FBSD-GD-9
	Power supply socket, angled, M12x1, 4-pin	For cable \varnothing 4 ... 6 mm	12956 SIE-WD-TR
		For cable \varnothing 6 ... 8 mm	18525 FBSD-WD-9
Fieldbus interface			
	Fieldbus socket, Sub-D connection	532216	FBS-SUB-9-GS-DP-B
	M12 adapter	525632	FBA-2-M12-5POL
Bus connection, 5-pin screw terminal strip			
	Open style adapter for 5-pin terminal strip	525634	FBA-1-SL-5POL
	5-pin terminal strip	525635	FBSD-KL-2x5POL
Valve terminal connection			
	Connecting cable, angled plug, angled socket	0.25 m	540327 KVI-CP-3-WS-WD-0.25
		0.5 m	540328 KVI-CP-3-WS-WD-0.5
		2 m	540329 KVI-CP-3-WS-WD-2
		5 m	540330 KVI-CP-3-WS-WD-5
		8 m	540331 KVI-CP-3-WS-WD-8
	Connecting cable, straight plug, straight socket	2 m	540332 KVI-CP-3-GS-GD-2
		5 m	540333 KVI-CP-3-GS-GD-5
		8 m	540334 KVI-CP-3-GS-GD-8
User documentation			
	User documentation for CPV Direct, CPV bus node DI02-8	German	548731 P.BE-CPV-DI02-DE
		English	548732 P.BE-CPV-DI02-EN
		Spanish	548733 P.BE-CPV-DI02-ES
		French	548734 P.BE-CPV-DI02-FR
		Italian	548735 P.BE-CPV-DI02-ITP.BE-CPV-IT

Festo - Your Partner in Automation



1 Festo Inc.
5300 Explorer Drive
Mississauga, ON L4W 5G4
Canada

Festo Customer Interaction Center
Tel: 1 877 463 3786
Fax: 1 877 393 3786
Email: customer.service.ca@festo.com



2 Festo Pneumatic
Av. Ceylán 3,
Col. Tequesquináhuac
54020 Tlalnepantla,
Estado de México

Multinational Contact Center
01 800 337 8669
ventas.mexico@festo.com



3 Festo Corporation
1377 Motor Parkway
Suite 310
Islandia, NY 11749

Festo Customer Interaction Center
1 800 993 3786
1 800 963 3786
customer.service.us@festo.com



4 Regional Service Center
7777 Columbia Road
Mason, OH 45040

Connect with us



www.festo.com/socialmedia



www.festo.com

Subject to change