

Electric cylinder units EPCE

FESTO

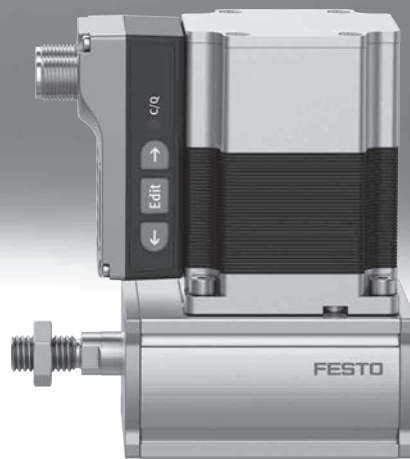

Key features

At a glance

Plug and work with the Simplified Motion Series



The simplicity of pneumatics is now combined for the first time with the advantages of electric automation thanks to the Simplified Motion Series. These integrated drives are the perfect solution for all users who are looking for an electric alternative for very simple movement and positioning tasks between two mechanical end positions, but don't want the commissioning process for traditional electric drive systems that can often be quite complex.

IO-Link

There is no need for any software since operation is simply based on the "plug and work" principle. Digital I/O (DIO) and IO-Link are always automatically included – a product with two types of control as standard.

Integrated

The integrated electronics in the drive are at the heart of the Simplified Motion Series.

Easy

For commissioning, simply set all relevant parameters directly on the drive:

- Speed and force
- Reference end position and cushioning
- Manual operation

Standardised

Electrical connection via M12 plug design

- Power (4-pin): power supply for the motor
- Logic (8-pin): control signal, sensor signal and power for the integrated electronics

Connected

Use of extended functions possible via IO-Link:

- Remote configuration of motion parameters
- Copy and backup function for transferring parameters
- Read function for extended process parameters
- Freely definable intermediate position
- Firmware update

The functions of the Simplified Motion Series

Basic profile for movement between two end positions: with speed control

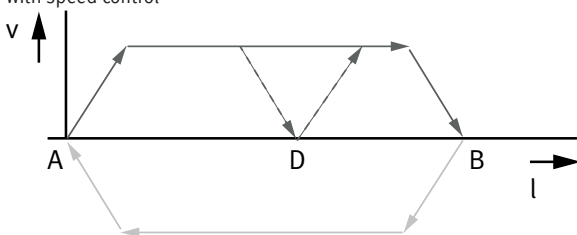

Extended motion profile for simplified press-fitting and clamping functions: with speed and force control

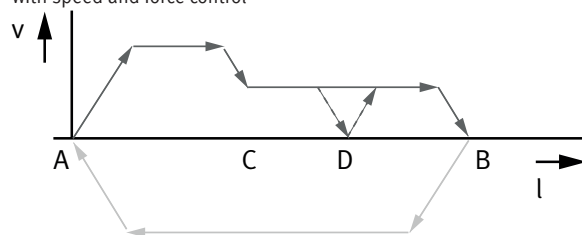

- These drives are designed for simple movements between two end positions.
- Proximity switches are required in order to implement any intermediate positions.
- With the intermediate position that can be freely configured via IO-Link, movements can be stopped at a freely defined point between the end positions, without the need for proximity switches or external stops

Key features

At a glance



- Without external servo drive: all the necessary electronic components are combined in the integrated drive
- Two control options integrated as standard: digital I/O and IO-Link
- Complete solution for simple movements between mechanical end positions
- Simplified commissioning: all parameters can be manually set directly on the drive
- No special expertise required for commissioning
- Minimal zero stroke and extremely compact design make this product the perfect choice for applications where space is at a premium
- Innovative interpretation of toothed belt technology for maximum dynamic response and minimal positioning times
- Ideal for fast movement in sorting, distribution and testing applications

The products in the Simplified Motion Series

Electric cylinder unit
EPCE

Electric cylinder unit
EPCS

Electric cylinder unit with parallel
motor mounting
EPCS



Mini slide unit
EGSS-BS-KF



Mini slide unit with parallel motor
mounting
EGSS-BS-KF

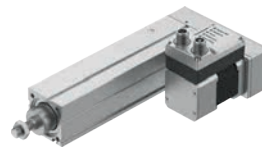

Spindle axis unit
ELGS-BS-KF

Spindle axis unit with parallel motor
mounting
ELGS-BS-KF



Toothed belt axis unit
ELGS-TB-KF

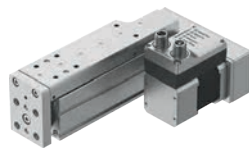

Toothed belt axis unit
ELGE



Rotary drive unit
ERMS

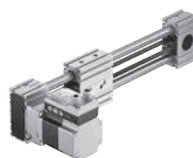
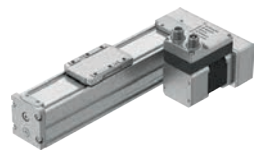

Piston rod variants

Front left

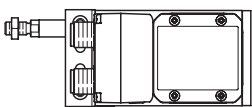

Front right

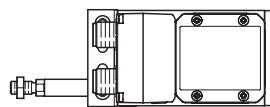

Rear left

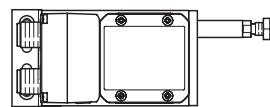

Rear right

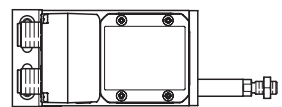

Double piston rod

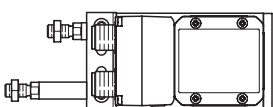

Through piston rod

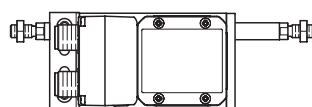

Piston rods acting in opposite
directions

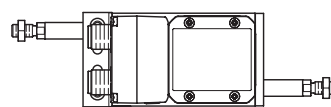

Other variants with 3 or 4 piston rods
available.

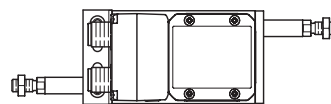
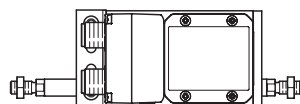
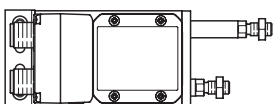

Peripherals overview

Cover variants

Standard

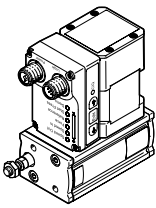

Multimount, front

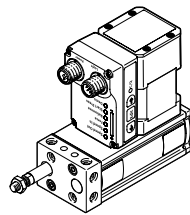

Multimount, rear

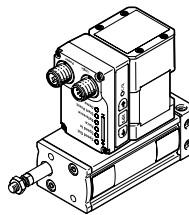

Multimount, both ends

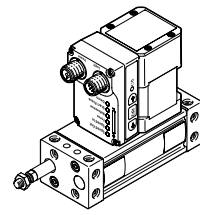

For the variants with multimount cover (EPCE-TB-...-MF / -MB / -MD), lateral female threads with centring diameter and through-holes are also available.

Mounting options

With standard cover variant

At the side via profile mounting

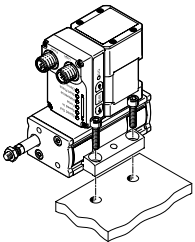

On the end face via thread

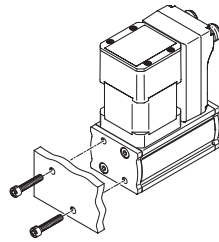

With multimount cover

On the end face via thread

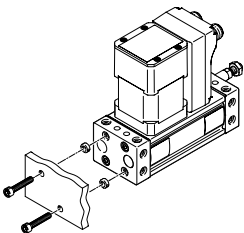

At the side/underneath via thread

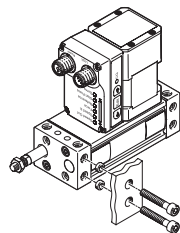

Via through-holes

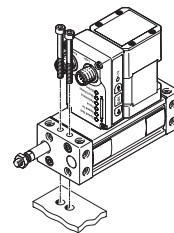

Cable outlet direction

Standard

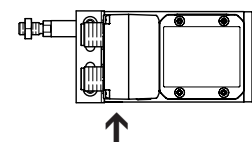

[B] Rear

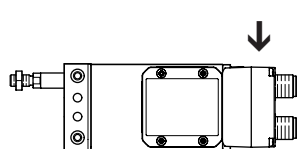

[L] Left

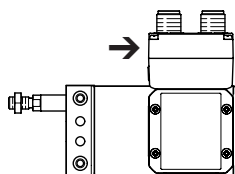

[R] Right

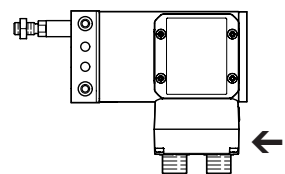

Control elements

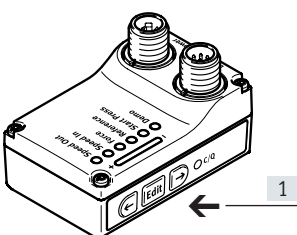

[1] Pushbutton actuators for parameterisation and control

Peripherals overview

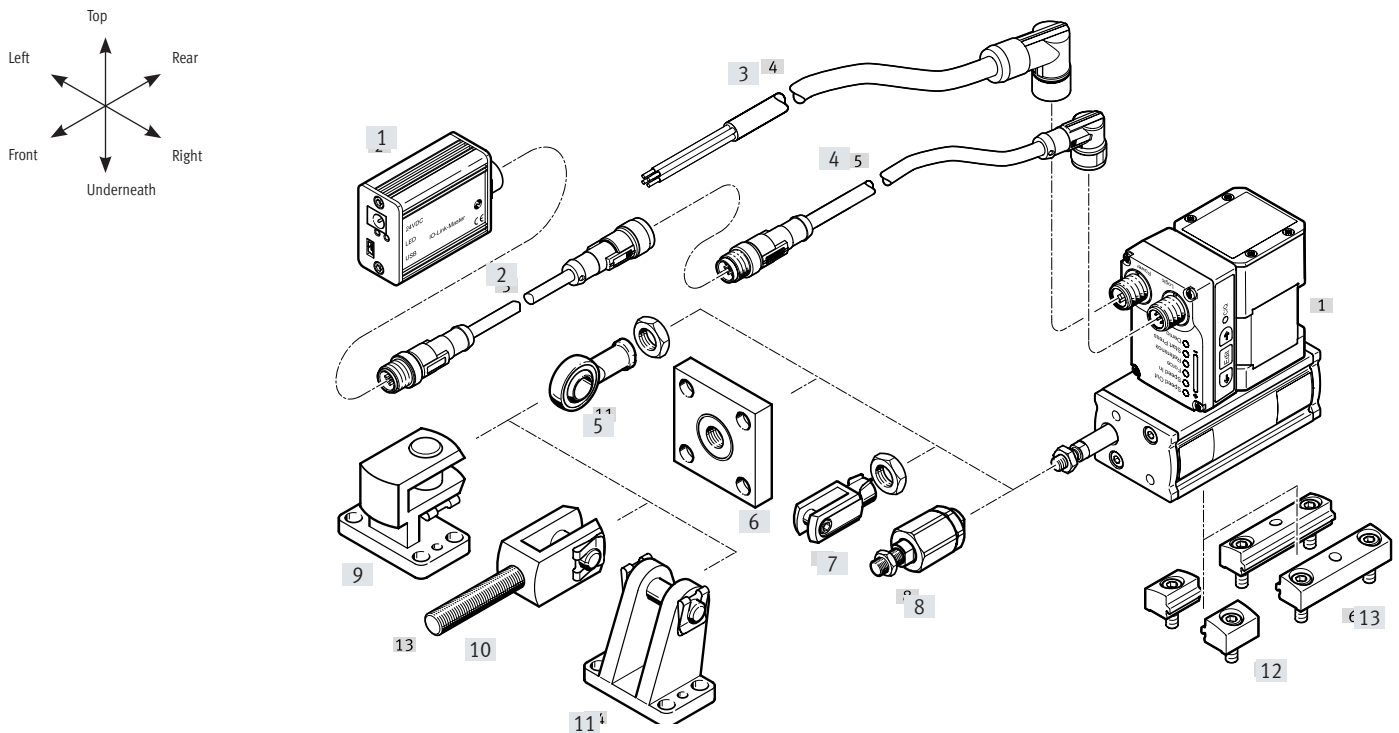

Accessories

Type/order code	Description	→ Page/Internet
[1] IO-Link master USB CDSU-1	For straightforward use of the electric cylinder unit with IO-Link	23
[2] Adapter NEFC-M12G8	Connection between the motor and the IO-Link master	23
[3] Supply cable NEBL-T12	For connecting load and logic supply	23
[4] Connecting cable NEBC-M12	For connection to a controller	23
[5] Rod eye SGS	With spherical bearing	22
[6] Coupling piece KSG	To compensate for radial deviations	22
[7] Rod clevis SG	Permits a swivelling movement of the cylinder in one plane	22
[8] Self-aligning rod coupler FK	To compensate for radial and angular deviations	22
[9] Right angle clevis foot LQG	For rod eye SGS	22
[10] Rod clevis SGA	For swivel mounting of the cylinder	22
[11] Clevis foot LBG	With parallel motor mounting, for spherical bearing	22
[12] Profile mounting EAHF-L2-P-S	For mounting the axis on the side of the profile	20
[13] Profile mounting EAHF-L2-P	<ul style="list-style-type: none"> For mounting the axis on the side of the profile The profile mounting can be attached to the mounting surface using the drilled hole in the centre 	21
- Centring sleeve ZBH	Centring sleeves can be used to centre the electric cylinder unit in combination with the multimount cover	22

Type codes

001	Series	
EPCE	Toothed belt	

002	Drive system	
TB	Toothed belt	

003	Size	
45	45	
60	60	

004	Stroke [mm]	
5	5	
10	10	
15	15	
20	20	
25	25	
30	30	
35	35	
40	40	
45	45	
50	50	
60	60	
80	80	

005	Piston rod, front left	
	None	
FL	Piston rod with male thread	

006	Piston rod, rear left	
	None	
BL	Piston rod with male thread	

007	Piston rod, front right	
	None	
FR	Piston rod with male thread	

008	Piston rod, rear right	
	None	
BR	Piston rod with male thread	

009	Cover variant	
	Standard	
MB	Multimount, rear	
MD	Multimount, both ends	
MF	Multimount, front	

010	Motor type	
ST	Stepper motor ST	

011	Controller	
M	Integrated	

012	Control panel	
H1	Integrated	

013	Bus protocol/activation	
PLK	PNP and IO-Link®	
NLK	NPN and IO-Link®	



014	End-position sensing	
AA	With integrated end-position sensing	

015	Cable outlet direction	
	Standard	
L	Left	
R	Right	
B	Rear	

016	Electrical accessories	
	None	
L1	Adapter for operation as IO-Link® device	

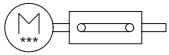
Datasheet



-  - Size
45, 60
-  - Stroke length
5 ... 80 mm

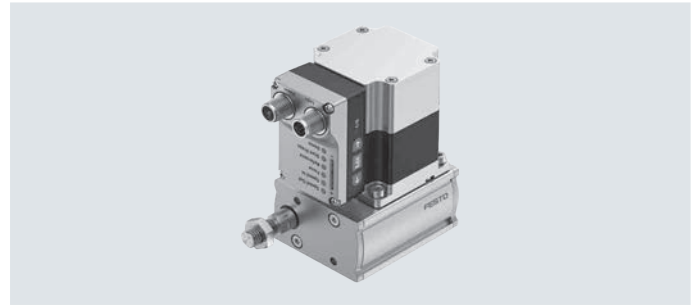

General technical data			
Size	45		60
Design	Electric cylinder with toothed belt and integrated drive		
Motor type	Stepper motor		
Protection against rotation/guide	With plain-bearing guide		
Piston rod end	Male thread		
Piston rod thread	M6	M10x1.25	
Mounting position	Any		
Working stroke [mm]	5, 10, 15, 20, 25, 30, 35, 40, 45, 50	5, 10, 15, 20, 25, 30, 35, 40, 45, 50, 60, 80	
Stroke reserve [mm]	0		
Additional functions	Built-in end-position sensing		
	User interface		
Display	LED		
Homing	Positive fixed stop block		
	Negative fixed stop block		
Type of mounting	With female thread		
	Via through-hole (only with multimount cover)		
	With accessories		
	Via centring sleeve (only with multimount cover)		
Max. cable length			
Inputs/outputs [m]	15		
IO-Link operation [m]	20		
Reference value, running performance	[km]	50 ... 500	50 ... 800
	[Cycles]	5 million	5 million

Mechanical data			
Size	45		60
Guide value for effective load			
Horizontal [kg]	5	10	
Vertical [kg]	2.5	5	
Max. feed force F_x [N]	85	150	
Max. speed ¹⁾ [m/s]	0.44	0.6	
Speed "Speed Press" ²⁾ [m/s]	0.02		
Max. acceleration ²⁾ [m/s ²]	9	9	
Repetition accuracy [mm]	±0.05	±0.05	
Max. impact energy [J]	0.003	0.016	
Position sensing	Via IO-Link		

1) Adjustable in increments of 10%

2) Unchangeable parameter

Datasheet

Toothed belt			
Size		45	60
Pitch	[mm]	2	
Elongation ¹⁾	[%]	0.310	0.375
Effective diameter	[mm]	10.18	
Feed constant	[mm/rev]	32	

1) At max. feed force

Electrical data			
Size		45	60
Motor			
Nominal voltage DC	[V]	24 (±15%)	
Nominal current	[A]	3	5.3
Max. current consumption (load)	[A]	3	5.3
Max. current consumption (logic)	[mA]	300	
Encoder			
Rotor position sensor		Absolute encoder, single turn	
Rotor position sensor measuring principle		Magnetic	
Rotor position encoder resolution	[bit]	16	

Interfaces			
Size		45	60
Parameterisation interface			
IO-Link		Yes	
User interface		Yes	
Digital inputs			
Number		2	
Switching logic		PNP	
		NPN	
Characteristics		Not galvanically isolated	
		Configurable	
Specification		Based on IEC 61131-2, type 1	
Operating range	[V]	24	
Digital outputs			
Number		2	
Switching logic		PNP	
		NPN	
Rotor position sensor		Absolute encoder, single turn	
Characteristics		Not galvanically isolated	
		Configurable	
Max. current	[mA]	100	

Datasheet

Technical data – IO-Link			
Size		45	60
SIO mode support		Yes	
Communication mode		COM3 (230.4 kBd)	
Connection technology		Plug	
Port class		A	
No. of ports		1	
Process data width OUT	[byte]	2	
Process data content OUT	[bit]	1 (Move in)	
	[bit]	1 (Move out)	
	[bit]	1 (Move Intermediate)	
	[bit]	1 (Quit Error)	
Process data width IN	[byte]	2	
Process data content IN	[bit]	1 (State Device)	
	[bit]	1 (State Move)	
	[bit]	1 (State in)	
	[bit]	1 (State out)	
Service data content IN	[bit]	32 (Force)	
	[bit]	32 (Position)	
	[bit]	32 (Speed)	
Minimum cycle time	[ms]	1	
Data memory required	[kilobyte]	0.5	
Protocol version		Device V 1.1	

Operating and environmental conditions			
Size		45	60
Insulation class		B	
Ambient temperature	[°C]	0 ... +50	
Storage temperature	[°C]	-20 ... +60	
Note on ambient temperature		Above an ambient temperature of 30°C, the power must be reduced by 2% per K	
Temperature monitoring		Switch-off for excessive temperature	
		Integrated precise CMOS temperature sensor with analogue output	
Relative humidity	[%]	0 ... 90 (non-condensing)	
Protection class		III	
Degree of protection		IP40	
Duty cycle	[%]	100	
CE marking (see declaration of conformity)		To EU EMC Directive for EMCS-ST → festo.com/sp	
		To EU RoHS Directive	
UKCA marking (see declaration of conformity)		To UK instructions for EMC	
		To UK RoHS instructions	
KC mark		KC EMC	
Certification		RCM	
Vibration resistance		Transport application test with severity level 1 to FN 942017-4 and EN 60068-2-6	
Shock resistance		Shock test with severity level 1 to FN 942017-5 and EN 60068-2-27	
Maintenance interval		Lifetime lubrication	

Weight			
Size		45	60
Basic weight at 0 mm stroke	[g]	775/813 ¹⁾	1350/1407 ¹⁾
Additional weight per 10 mm stroke	[g]	29	46
Moving mass with 0 mm stroke	[g]	83/87 ¹⁾	188/197 ¹⁾
Additional moving mass per 10 mm stroke	[g]	4.55	9.75

1) With cover variant EPCE...-MF

Datasheet

Materials

Sectional view

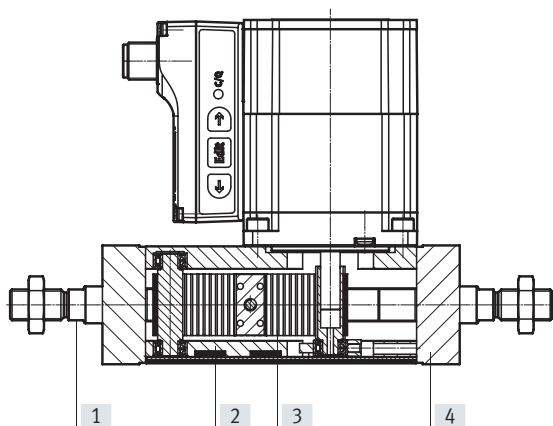

Axis		
[1]	Piston rod	High-alloy stainless steel
[2]	Housing	Anodised wrought aluminium alloy
[3]	Toothed belt	Polychloroprene with glass fibre
[4]	Cover	Anodised wrought aluminium alloy
PWIS conformity		VDMA24364 zone III
Note on materials		RoHS-compliant

Pin allocation

Power supply

Plug

M12x1, 4-pin, T-coded to EN 61076-2-111

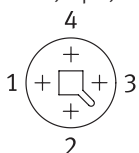

Pin	Function
1	Power voltage supply (24 V DC)
2	Reference potential, power voltage supply (GND)
3	Reserved, do not connect
4	Functional earth (FE)

Logic interface

Plug

M12x1, 8-pin, A-coded to EN 61076-2-101

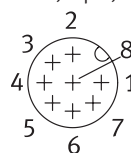

When used with digital I/O	
Pin	Function
1	Logic voltage supply (24 V DC)
2	Digital output 1 (State "In")
3	Digital output 2 (State "Out")
4	Reference potential, logic voltage supply (GND)
5	Digital input 1 (Move "In")
6	Digital input 2 (Move "Out")
7	Reserved, do not connect
8	Reference potential, logic voltage supply (GND)

When used with IO-Link	
Pin	Function
1	L+ IO-Link power supply (24 V DC)
2	Reserved, do not connect
3	C/Q communication with the IO-Link master
4	L – Reference potential, IO-Link power supply (0 V)
5	Reserved, do not connect
6	Reserved, do not connect
7	Reserved, do not connect
8	L – Reference potential, IO-Link power supply (0 V)

Datasheet

Maximum permissible loads on the piston rod

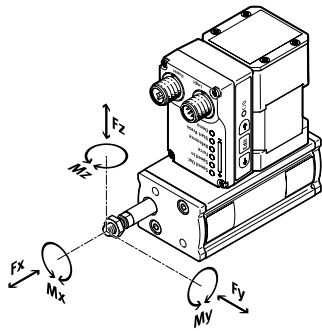

If there are two or more forces and torques simultaneously acting on the piston rod, the following equations must be satisfied:

F_1/M_1 = dynamic value
 F_2/M_2 = maximum value

$$f_v = \frac{|F_{y1}|}{F_{y2}} + \frac{|F_{z1}|}{F_{z2}} + \frac{|M_{y1}|}{M_{y2}} + \frac{|M_{z1}|}{M_{z2}} \leq 1$$

$$|Fx| \leq Fx_{max}$$

$$|Mx| \leq Mx_{max}$$

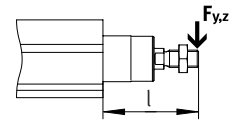

Maximum permissible lateral forces $F_{y_{max}}$ and $F_{z_{max}}$ on the piston rod as a function of projection l

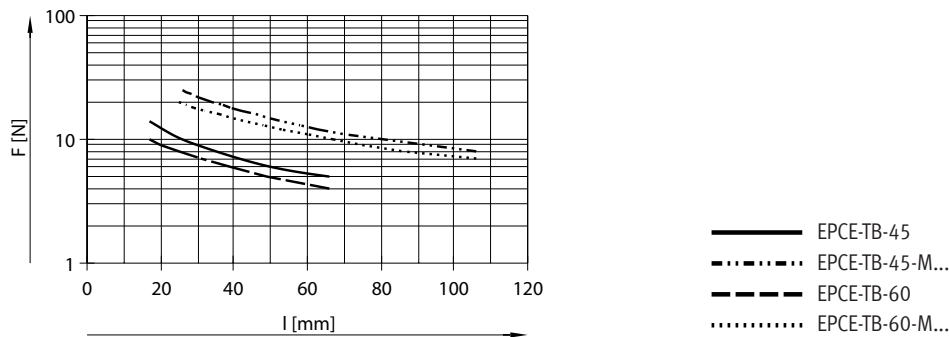

Size		45	60
Fx_{max} (static)	[N]	85	150
Mx_{max} (dynamic)	[Nm]	0	
My_{max}, Mz_{max}	[Nm]	0.9	2.9

Piston rod deflection f as a function of projection A

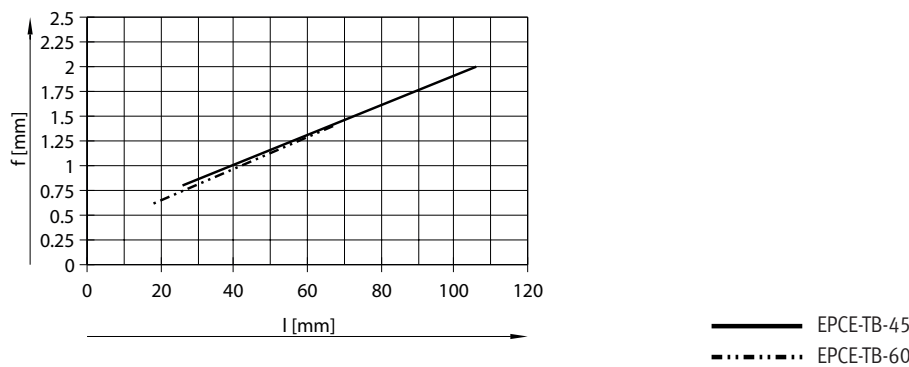
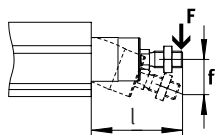

Datasheet

Sizing example

Application data:

- Payload: 8 kg
- Mounting position: horizontal
- Stroke: 60 mm
- Max. permissible positioning time: 0.5 s (one direction)

Step 1: Selecting the smallest possible size from the table → page 12

Mechanical data

Size		45		60
Max. payload				
Horizontal	[kg]	5		10
Vertical	[kg]	2.5		5

→ Smallest possible size: EPCE-TB-60

Step 2: Selecting the max. speed level v for payload m

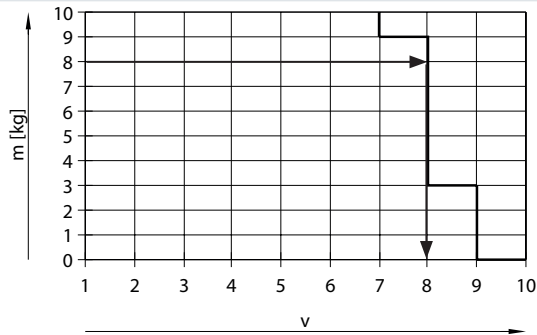

→ Max. speed level for payload: level 8

Step 3: Reading off the min. positioning time t for stroke l

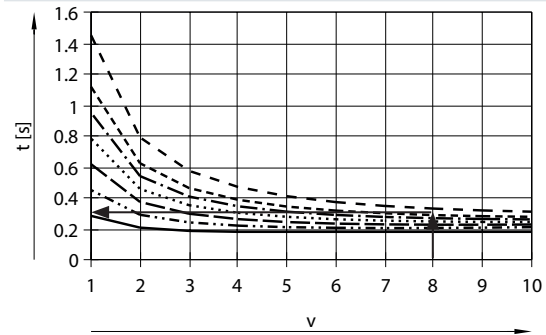

- l = 10 mm
- l = 20 mm
- - - l = 30 mm
- · - · - l = 40 mm
- · - - - l = 50 mm
- - - - - l = 60 mm
- · - · - · l = 80 mm

→ Min. positioning time for 60 mm at level 8: 0.3 s

Result

The application can be implemented using EPCE-TB-60-60. A minimum positioning time (one direction) of 0.3 s is achieved. Longer positioning times can be selected at any time using a lower speed level.

Datasheet

Mass m as a function of speed level v

Horizontal

EPCE-45

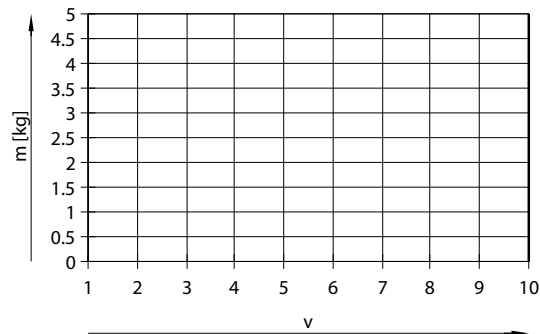

Vertical

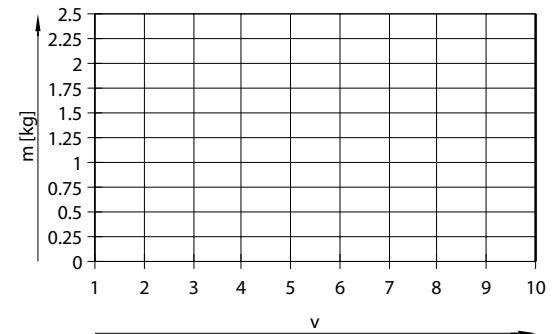

EPCE-45

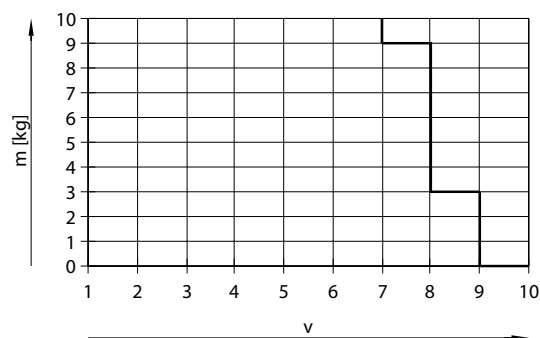

EPCE-60

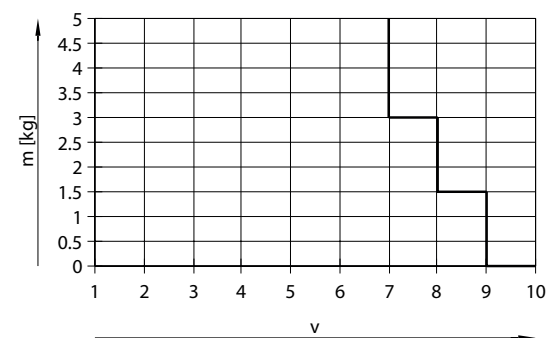

EPCE-60



 Note

The lines represent the maximum values. The lower speed levels can be set at any time.

Datasheet

Positioning time t as a function of speed level v and stroke l

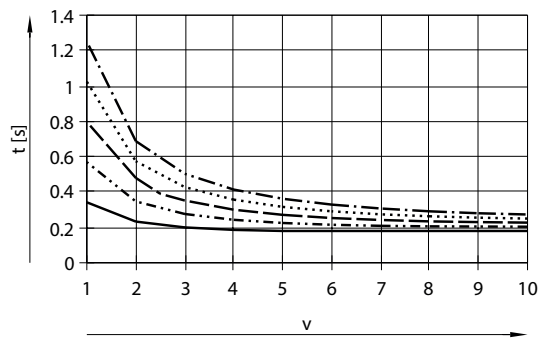
EPCE-45



- $l = 10$ mm
- $l = 20$ mm
- - - $l = 30$ mm
- · - · $l = 40$ mm
- - - - $l = 50$ mm

EPCE-60

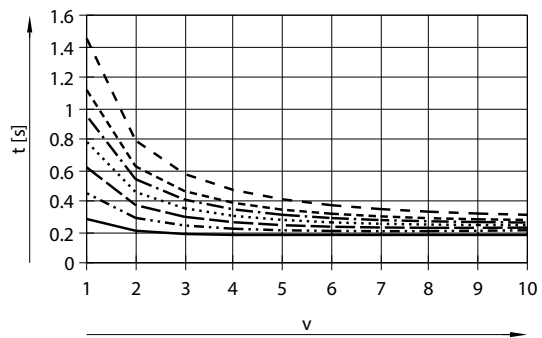

- $l = 10$ mm
- $l = 20$ mm
- - - $l = 30$ mm
- · - · $l = 40$ mm
- - - - $l = 50$ mm
- - - - $l = 60$ mm
- - - - $l = 80$ mm

Speed v as a function of speed level v

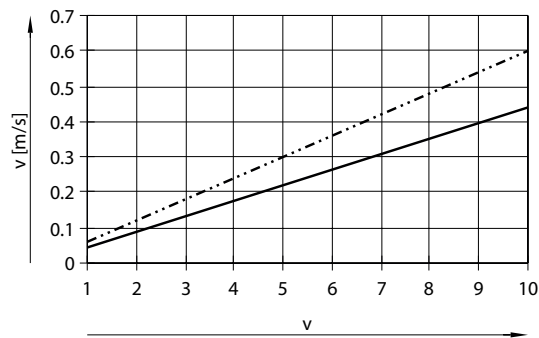

- EPCE-TB-45
- EPCE-TB-60

Feed force F as a function of force level F_1

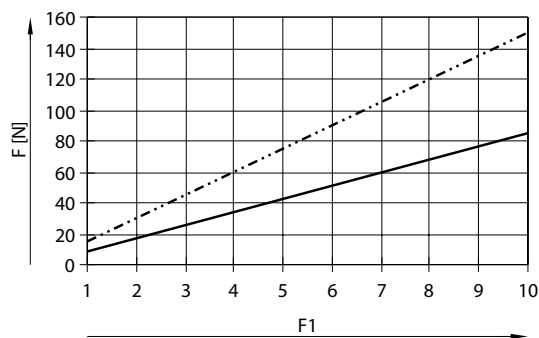

- EPCE-TB-45
- EPCE-TB-60

Datasheet

Dimensions

With cover variant – Standard

Download CAD data → www.festo.com

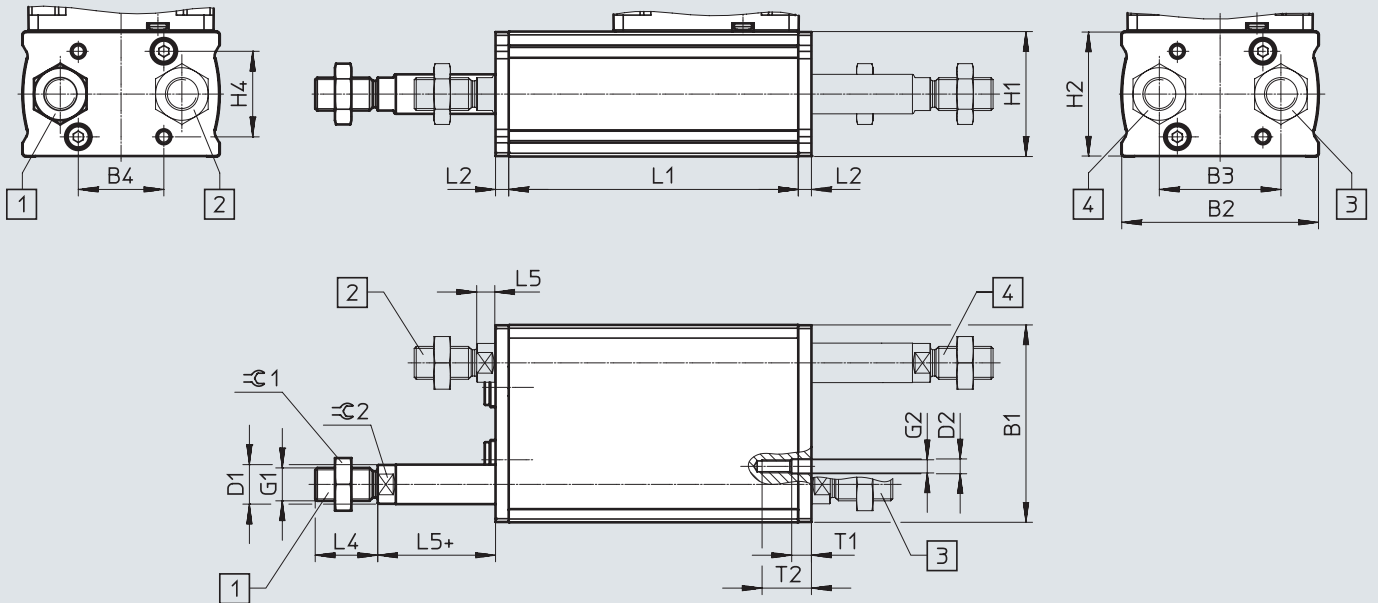

+ = plus stroke length

- [1] EPCE-TB-...-FL
- [2] EPCE-TB-...-FR
- [3] EPCE-TB-...-BL
- [4] EPCE-TB-...-BR

Size	B1	B2	B3	B4	D1 ∅	D2 ∅	G1	G2	H1
	+0.4	±0.1			h8	H13			+0.3/-0.1
45	45	44.8	28	20	8	4.5	M6	M4	34
60	60	59.8	37	26	12	4.5	M10x1.25	M4	38

Size	H2	H4	L2	L4	L5	T1	T2	⌀ 1	⌀ 2
	±0.1		±0.1						
45	33.7	22.5	4	12	4.7+0.2/-1.2	6	15	10	7
60	37.7	26	4	19	6+0.2/-1.3	6	15	17	10

Size	Stroke [mm]	L1 ±0.1
45	5	59.5
	10	59.5
	15	69.5
	20	69.5
	25	79.5
	30	79.5
	35	89.5
	40	89.5
	45	99.5
	50	99.5

Size	Stroke [mm]	L1 ±0.1
60	5	68
	10	68
	15	78
	20	78
	25	88
	30	88
	35	98
	40	98
	45	108
	50	108
60	118	
80	138	

- Note
Spanner flat ⌀2 can be aligned either way.

Datasheet

Dimensions

Download CAD data → www.festo.com

With cover variant – Multimount

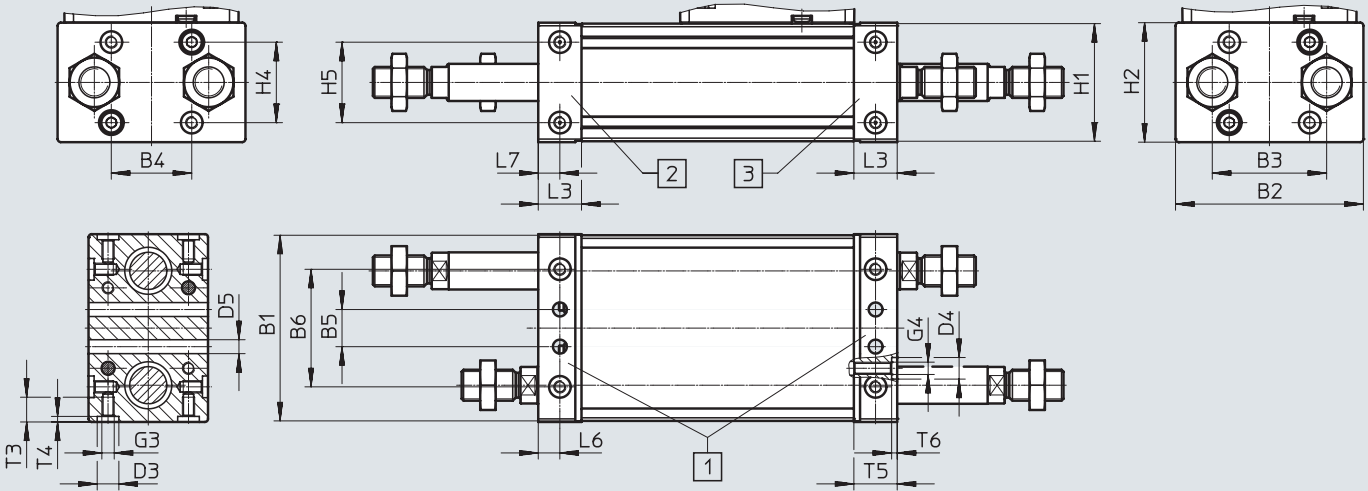

- [1] EPCE-TB-...-MD
- [2] EPCE-TB-...-MF
- [3] EPCE-TB-...-M

Size	B1	B2	B3	B4	B5	B6	D3 ∅	D4 ∅	D5 ∅	G3	G4
	+0.4	±0.1					H7	H7	H13		
45	45	45.7	28	20	10	32.5	7	7	4.5	M4	M4
60	60	60.7	37	26	12	38	7	7	4.5	M4	M4

Size	H1	H2	H4	H5	L3	L6	L7	T3	T4	T5	T6
	+0.3/-0.1	±0.1			±0.1				-0.1		-0.1
45	34	34.6	22.5	16	14	7	7	8	1.8	14	1.8
60	38	38.6	26	26	14	7	7	8	1.8	14	1.8

Note

For size 60, the through-holes cannot be used with the following combinations:

- Through-hole at the front: not in combination with stroke 5 or 10 mm and motor mounting variant "Standard" (at front)
- Through-hole at the rear: not in combination with motor mounting variant "Rear"

Datasheet

Dimensions

Motor mounting

Download CAD data → www.festo.com

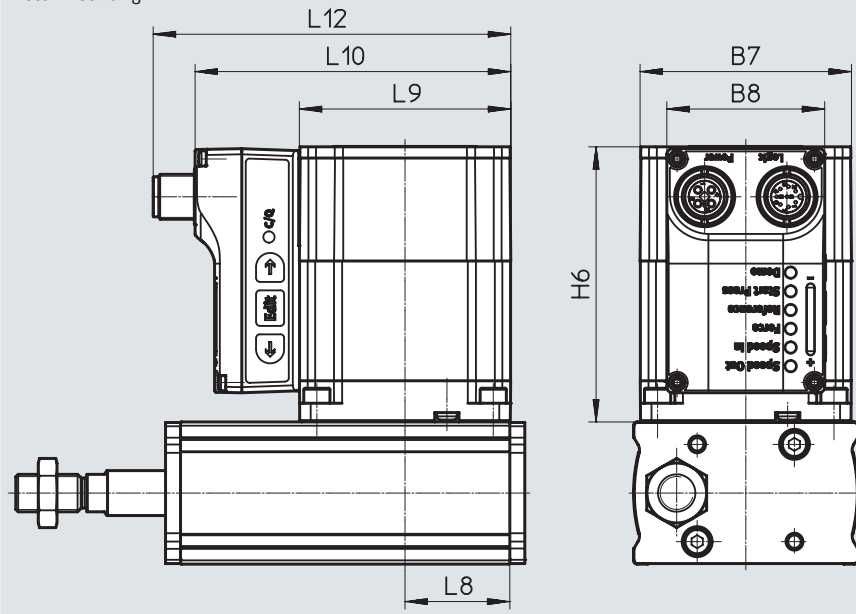

Size	B7	B8	H6	L8	L9	L10	L12
	±0.3	±0.25			±0.3	±0.6	±0.8
45	42.3	42.2	65±1.1	21	42.3	70.1	81.3
60	56.6	42.2	73.5±0.9	28	56.6	84.5	95.6

Datasheet

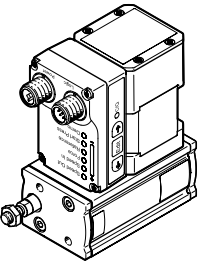
Ordering data				
	Size	Stroke	Part no. Type	
	45	Cover variant: Standard		
		10	8101539	EPCE-TB-45-10-FL-ST-M-H1-PLK-AA
		20	8101540	EPCE-TB-45-20-FL-ST-M-H1-PLK-AA
		30	8101541	EPCE-TB-45-30-FL-ST-M-H1-PLK-AA
		50	8101542	EPCE-TB-45-50-FL-ST-M-H1-PLK-AA
		Cover variant: Multimount, front		
		20	8101544	EPCE-TB-45-20-FL-MF-ST-M-H1-PLK-AA
		30	8101545	EPCE-TB-45-30-FL-MF-ST-M-H1-PLK-AA
		50	8101546	EPCE-TB-45-50-FL-MF-ST-M-H1-PLK-AA
		60	Cover variant: Standard	
	10		8102163	EPCE-TB-60-10-FL-ST-M-H1-PLK-AA
	20		8102162	EPCE-TB-60-20-FL-ST-M-H1-PLK-AA
	30		8102164	EPCE-TB-60-30-FL-ST-M-H1-PLK-AA
	50		8102170	EPCE-TB-60-50-FL-ST-M-H1-PLK-AA
	80		8102167	EPCE-TB-60-80-FL-ST-M-H1-PLK-AA
	Cover variant: Multimount, front			
	10		8102166	EPCE-TB-60-10-FL-MF-ST-M-H1-PLK-AA
20	8102169	EPCE-TB-60-20-FL-MF-ST-M-H1-PLK-AA		
30	8102168	EPCE-TB-60-30-FL-MF-ST-M-H1-PLK-AA		
50	8102165	EPCE-TB-60-50-FL-MF-ST-M-H1-PLK-AA		
80	8102171	EPCE-TB-60-80-FL-MF-ST-M-H1-PLK-AA		

Datasheet

Ordering table					
Size	45	60	Conditions	Code	Enter code
Module no.	8103354	8103355			
Series	EPCE			EPCE	EPCE
Drive system	Toothed belt			-TB	-TB
Size	45	60		-...	
Stroke [mm]	5, 10, 15, 20, 25, 30, 35, 40, 45, 50	5, 10, 15, 20, 25, 30, 35, 40, 45, 50, 60, 80		-...	
Piston rod, front left	None		[1]		
	Piston rod with male thread			-FL	
Piston rod, rear left	None		[1]		
	Piston rod with male thread			-BL	
Piston rod, front right	None		[1]		
	Piston rod with male thread			-FR	
Piston rod, rear right	None		[1]		
	Piston rod with male thread			-BR	
Cover variant	Standard				
	Multimount, rear		[3]	-MB	
	Multimount, both ends		[2], [3]	-MD	
	Multimount, front		[2]	-MF	
Motor type	Stepper motor ST			-ST	-ST
Controller	Integrated			-M	-M
Control panel	Integrated			-H1	-H1
Bus protocol/control	NPN and IO-Link			-NLK	
	PNP and IO-Link			-PLK	
End-position sensing	With integrated end-position sensing			-AA	-AA
Cable outlet direction	Standard		[2]		
	Rear		[3]	-B	
	Left			-L	
	Right			-R	
Electrical accessories	None				
	Adapter for operation as IO device			+L1	

[1] At least one piston rod must be selected.

[2] For size 45 with stroke 5 mm or 10 mm and cover variant -MF or -MD, not in combination with cable outlet direction "Standard".

[3] For size 45 and cover variant -MB or -MD, not in combination with cable outlet direction "Rear"

 **Note**

For size 60, the through-holes cannot be used with the following combinations:

- Through-hole at the front: not in combination with stroke 5 or 10 mm and motor mounting variant "Standard" (at front)
- Through-hole at the rear: not in combination with motor mounting variant "Rear"

Accessories

Profile mounting EAHF-L2-...-P-S

Material:
Anodised wrought aluminium alloy
RoHS-compliant

- For mounting the cylinder on the side of the profile

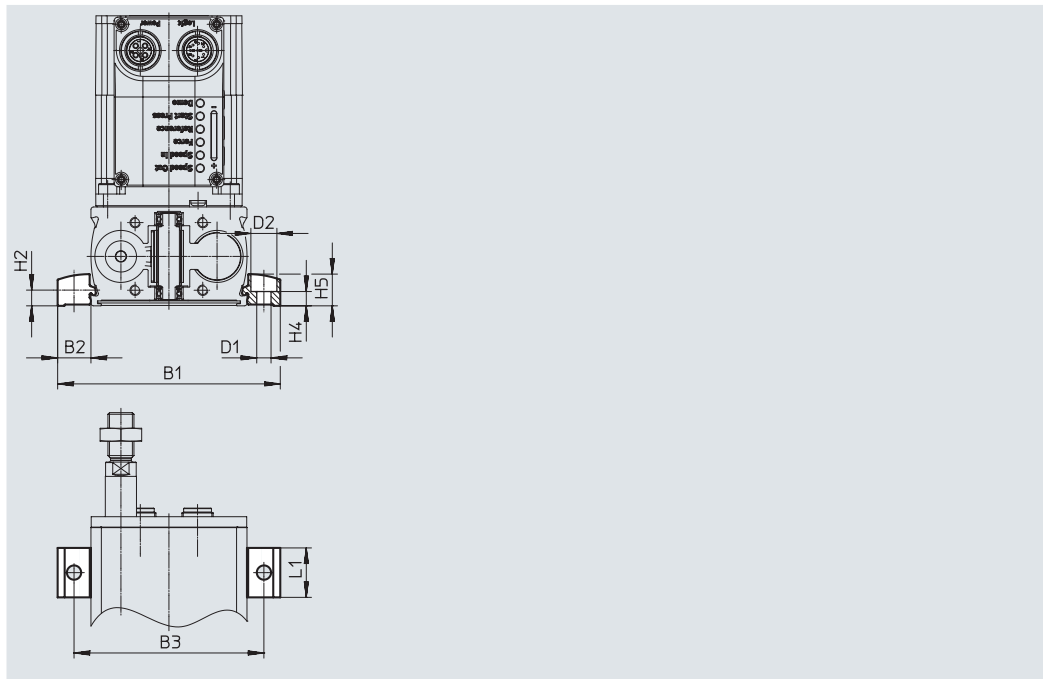
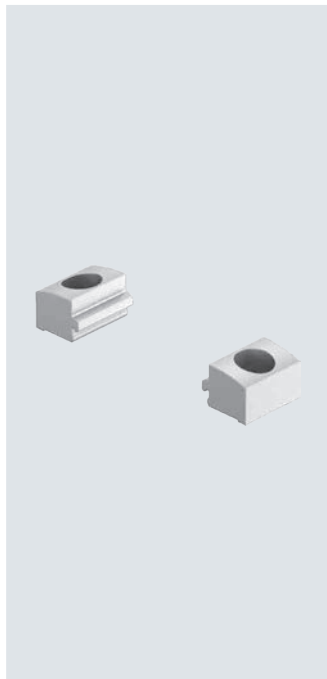

Dimensions and ordering data

For size	B1	B2	B3	D1 ∅ H13	D2 ∅ H13	H2
45	70.6	12.8	58	5.5	10	6.1
60	85.6	12.8	73	5.5	10	6.1

For size	H4 ±0.1	H5	L1	Weight [g]	Part no.	Type
45	5.5	12.2	19	6	5184133	EAHF-L2-45-P-S
60	5.5	12.2	19	6	5184133	EAHF-L2-45-P-S

Accessories

Profile mounting EAHF-L2-...-P

Material:

Anodised wrought aluminium alloy

RoHS-compliant

- For mounting the cylinder on the side of the profile.
The profile mounting can be attached to the mounting surface using the drilled hole in the centre

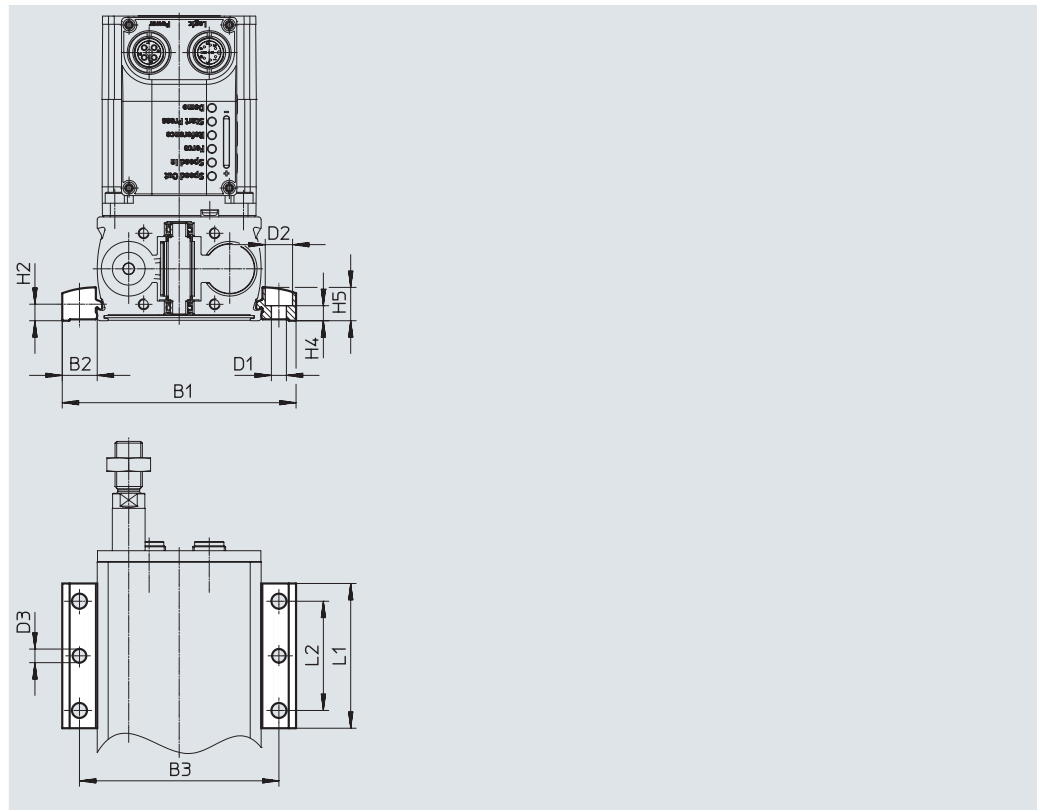
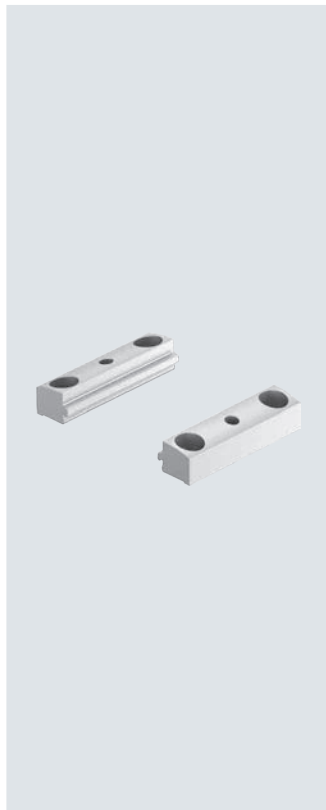

Dimensions and ordering data

For size	B1	B2	B3	D1 ∅ H13	D2 ∅ H13	D3 ∅	H2
45	70.6	12.8	58	5.5	10	5	6.1
60	85.6	12.8	73	5.5	10	5	6.1

For size	H4 ±0.1	H5	L1	L2	Weight [g]	Part no.	Type
45	5.5	12.2	53	40	35	4835728	EAHF-L2-45-P
60	5.5	12.2	53	40	35	4835728	EAHF-L2-45-P

Accessories

Ordering data – Mounting components

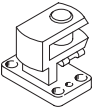
Designation	For size	Part no.	Type
Right angle clevis foot LQG			
	60	31768	LQG-32

Datasheets → Internet: clevis foot

Designation	For size	Part no.	Type
Clevis foot LBG			
	60	31761	LBG-32

Ordering data – Piston rod attachments

Designation	For size	Part no.	Type
Rod eye SGS			
	45	9254	SGS-M6
	60	9261	SGS-M10x1.25

Datasheets → Internet: piston rod attachment

Designation	For size	Part no.	Type
Rod clevis SG			
	45	3110	SG-M6
	60	6144	SG-M10x1.25

Self-aligning rod coupler FK

	45	2061	FK-M6
	60	6140	FK-M10x1.25

Rod clevis SGA

	60	32954	SGA-M10x1.25
---	----	--------------	---------------------

Coupling piece KSG

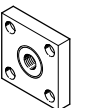
	60	32963	KSG-M10x1.25
---	----	--------------	---------------------

Ordering data – Centring sleeves

	Description	Part no.	Type	PU ¹⁾
	<ul style="list-style-type: none"> For centring the electric cylinder unit in combination with multimount cover (EPCE-TB-...-MF / -MB / -MD) 	8146544	ZBH-7-B	10

1) Packaging unit

Accessories

Ordering data – IO-Link master USB		Datasheets → Internet: cdsu		
	Description	Cable length [m]	Part no.	Type
	<ul style="list-style-type: none"> For using the unit with IO-Link An external power supply plug is also required (not included in the scope of delivery) 	0.3	8091509	CDSU-1

Ordering data – Adapter		Datasheets → Internet: nefc			
	Electrical connection, left	Electrical connection, right	Cable length [m]	Part no.	Type
	Straight socket, M12x1, 8-pin	Straight plug, M12x1, 5-pin	0.3	8080777	NEFC-M12G8-0.3-M12G5-LK

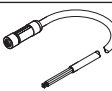
Ordering data – Supply cables		Datasheets → Internet: nebl			
	Electrical connection, left	Electrical connection, right	Cable length [m]	Part no.	Type
	Angled socket, M12x1, 4-pin	Cable, open end, 4-wire	2	8080778	NEBL-T12W4-E-2-N-LE4
			5	8080779	NEBL-T12W4-E-5-N-LE4
			10	8080780	NEBL-T12W4-E-10-N-LE4
			15	8080781	NEBL-T12W4-E-15-N-LE4
	Straight socket, M12x1, 4-pin	Cable, open end, 4-wire	2	8080790	NEBL-T12G4-E-2-N-LE4
			5	8080791	NEBL-T12G4-E-5-N-LE4
			10	8080792	NEBL-T12G4-E-10-N-LE4
			15	8080793	NEBL-T12G4-E-15-N-LE4

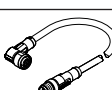
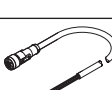
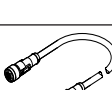
Ordering data – Connecting cables		Datasheets → Internet: nebc			
	Electrical connection, left	Electrical connection, right	Cable length [m]	Part no.	Type
	Angled socket, M12x1, 8-pin	Cable, open end, 8-wire	2	8094476	NEBC-M12W8-E-2-N-B-LE8
			5	8094478	NEBC-M12W8-E-5-N-B-LE8
			10	8094481	NEBC-M12W8-E-10-N-B-LE8
			15	8094479	NEBC-M12W8-E-15-N-B-LE8
	Straight plug, M12x1, 8-pin	Cable, open end, 8-wire	2	8080786	NEBC-M12W8-E-2-N-M12G8
			5	8080787	NEBC-M12W8-E-5-N-M12G8
			10	8080788	NEBC-M12W8-E-10-N-M12G8
			15	8080789	NEBC-M12W8-E-15-N-M12G8
	Straight socket, M12x1, 8-pin	Cable, open end, 8-wire	2	8094480	NEBC-M12G8-E-2-N-B-LE8
			5	8094477	NEBC-M12G8-E-5-N-B-LE8
			10	8094482	NEBC-M12G8-E-10-N-B-LE8
			15	8094475	NEBC-M12G8-E-15-N-B-LE8
	Straight plug, M12x1, 8-pin	Cable, open end, 8-wire	2	8080782	NEBC-M12G8-E-2-N-M12G8
			5	8080783	NEBC-M12G8-E-5-N-M12G8
			10	8080784	NEBC-M12G8-E-10-N-M12G8
			15	8080785	NEBC-M12G8-E-15-N-M12G8

 **Note**
The cables are positioned at a 45° angle to the axis.

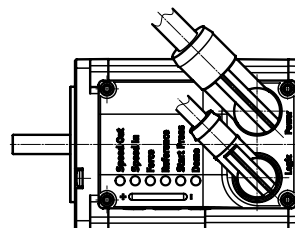

Festo - Your Partner in Automation



1 Festo Inc.
5300 Explorer Drive
Mississauga, ON L4W 5G4
Canada

Festo Customer Interaction Center
Tel: 1 877 463 3786
Fax: 1 877 393 3786
Email: customer.service.ca@festo.com

2 Festo Pneumatic
Av. Ceylán 3,
Col. Tequesquináhuac
54020 Tlalneantla,
Estado de México

Multinational Contact Center
01 800 337 8669
ventas.mexico@festo.com

3 Festo Corporation
1377 Motor Parkway
Suite 310
Islandia, NY 11749

Festo Customer Interaction Center
1 800 993 3786
1 800 963 3786
customer.service.us@festo.com

4 Regional Service Center
7777 Columbia Road
Mason, OH 45040

Connect with us



www.festo.com/socialmedia



www.festo.com

Subject to change