

## Servo motors EMMS-AS

**FESTO**



## Key features

### Everything from a single source

Motors EMMS-AS

→ Page 4



- Dynamic, brushless, permanently excited synchronous servo motors
- Choice of feedback systems:
  - Digital absolute encoder, single-turn
  - Digital absolute encoder, multi-turn
  - Resolver
- Optimised connection technology, depending on the version and flange size
- Winding variants
  - For single-phase motor controller
  - For three-phase motor controller
  - Optimised torque
  - Speed-optimised
- Protection class: IP54 (motor shaft)
- Protection class: IP65 (motor housing with connection technology)
- Optional:
  - Holding brake
  - Featherkey
  - Protection class IP65: with shaft seal for motor shaft

### Gear unit EMGA-SAS

→ Page 16



- Low-backlash planetary gear
- Gear ratio  $i = 3, 5, 8, 12, 20$
- Life-time lubrication
- Degree of protection: IP54

### Servo drive CMMT-AS

→ Internet: [cmmt-as](http://cmmt-as)



- Universal servo drive for synchronous servo motors
- Integrated EMC filters
- Integrated brake chopper
- Integrated braking resistor
- Integrated safety functions
- Position controller
- Speed controller
- Force controller
- Range of control functions
- Interfaces:
  - EtherCAT
  - PROFINET RT/IRT
  - EtherNet/IP
  - Modbus TCP

### Motor and encoder cables NEBM

→ Page 18



- Suitable for energy chains
- Connection technology on motor side with degree of protection to IP65
- Can be used in a wide temperature range

### Axial and parallel kits EAMM

→ Internet: [eamm](http://eamm)



- Specific kits for all electromechanical axes from Festo
- Each kit includes the relevant necessary coupling housing, couplings and motor flange as well as all screws
- Optionally with degree of protection IP65

## Type codes

001	Series
EMMS	Motor

002	Motor type
AS	AC synchronous

003	Flange size, motors
40	40
55	55
70	70
100	100
140	140
190	190

004	Length
S	Short
M	Centre
L	Long

005	Output shaft
	Smooth shaft
K	Shaft to DIN 6885

006	Winding
LS	Low voltage, standard
LV	Low voltage, speed optimised
HS	High voltage, standard
HV	High voltage, speed optimised

007	Electrical connection
T	Terminal box
A	Angled plug
R	Angled connector, adjustable
S	Straight plug

008	Measuring unit
R	Resolver
S	Absolute encoder, single turn
M	Absolute encoder, multi-turn

009	Brake
	None
B	With brake

010	Degree of protection, electrical system
	Standard
S1	IP65

Data sheet



**Note**  
Motors and motor controllers from Festo have been specially designed to be used together. Trouble-free operation cannot be guaranteed in combination with third-party controllers.



Technical data					
Flange size		140			
Overall length		S	S	L	L
Winding		HS	HV	HS	HV
<b>Motor</b>					
Nominal voltage	[V DC]	565	565	565	565
Nominal current	[A]	4.40	5.23	7.80	9.96
Peak current	[A]	15	24.40	20	51.50
Nominal power	[W]	2600	3140	4420	5110
Nominal torque	[Nm]	9.55	7.70	21.12	17.41
Peak torque	[Nm]	25.60	27	48.80	67.50
Stall torque	[Nm]	11.20	11.08	25.60	25.50
Nominal rotational speed	[rpm]	2600	3900	2000	2800
Max. rotational speed	[rpm]	3060	4510	2460	3830
Motor constant	[Nm/A]	2.166	1.47	2.72	1.75
Voltage constant phase-to-phase	[mV/min]	130.69	88.71	162.39	104.41
Number of pole pairs		6	6	6	6
Winding resistance	[Ω]	3.39	1.60	1.41	0.586
Winding inductance	[mH]	20.50	9.01	13.44	4.65
Total output moment of inertia					
Encoder					
Without brake	[kgcm <sup>2</sup> ]	8.189	8.189	19.027	19.027
With brake	[kgcm <sup>2</sup> ]	9.271	9.271	20.108	20.108
Resolver					
Without brake	[kgcm <sup>2</sup> ]	8	8	18.400	18.400
With brake	[kgcm <sup>2</sup> ]	9	9	19.400	19.400
Shaft load					
Radial	[N]	780	780	1 060	1 060
Axial	[N]	200	200	200	200
<b>Brake</b>					
Operating voltage	[V DC]	24 +6 ... -10%			
Power	[W]	15.6			
Holding torque	[Nm]	18			
Mass moment of inertia					
Encoder	[kgcm <sup>2</sup> ]	1.2			
Resolver	[kgcm <sup>2</sup> ]	1.0			

## Data sheet

Technical data			
Flange size		190	
Overall length		S	M
Winding		HS	HS
Motor			
Nominal voltage	[V DC]	565	565
Nominal current	[A]	14.43	14.24
Peak current	[A]	77.20	88.20
Nominal power	[W]	5490	6880
Nominal torque	[Nm]	17.47	22.63
Peak torque	[Nm]	80	120
Stall torque	[Nm]	26.20	38.77
Nominal rotational speed	[rpm]	3000	2900
Max. rotational speed	[rpm]	5300	4060
Motor constant	[Nm/A]	1.211	1.589
Voltage constant phase-to-phase	[mV/min]	75.4	98.6
Number of pole pairs		6	6
Winding resistance	[Ω]	0.283	0.265
Winding inductance	[mH]	3.07	3.38
Total output moment of inertia			
Encoder			
Without brake	[kgcm <sup>2</sup> ]	51.90	76.80
With brake	[kgcm <sup>2</sup> ]	55.70	80.60
Resolver			
Without brake	[kgcm <sup>2</sup> ]	52.10	77.00
With brake	[kgcm <sup>2</sup> ]	55.70	80.60
Shaft load			
Radial	[N]	940	1 080
Axial	[N]	250	250
Brake			
Operating voltage	[V DC]	24 +6 ... -10%	
Power	[W]	17	
Holding torque	[Nm]	30	
Mass moment of inertia			
Encoder	[kgcm <sup>2</sup> ]	3.8	
Resolver	[kgcm <sup>2</sup> ]	3.6	

## Data sheet

Technical data – Encoder		Absolute, single-turn	Absolute, multi-turn
Measuring unit			
Operating voltage	[V DC]	5	
Operating voltage range	[V DC]	3.6 ... 14	
Protocol		EnDat 2.2, digital channel only, max. cycle rate (CLOCK) ≤ 16 MHz	
Position values per revolution		262144	524288
Rotor position encoder resolution		18 bits	19 bits
Revolutions		–	4096 revolutions, 12 bits

Technical data – Resolver		Transmitter
Design		
Input voltage	[V DC]	4
Input current	[mA]	50
Number of poles		2
Carrier frequency	[kHz]	3.4 ... 8.0

Weight [kg]				
Flange size		140	190	
Overall length		S	L	M
Encoder				
Without brake		9.60	16.20	20.86
With brake		10.40	17.00	21.96
Resolver				
Without brake		9.84	16.44	21.10
With brake		10.64	17.24	22.20

Operating and environmental conditions		
Standard		IEC 60034
Degree of protection		
Motor shaft		IP54
Motor housing incl. connection technology		IP65
With shaft sealing ring		IP65
Ambient temperature		
Encoder	[°C]	–10 ... +40 (up to 100°C with derating)
Resolver	[°C]	–40 ... +40 (up to 130°C with derating)
Storage temperature	[°C]	–20 ... +60
Temperature monitoring		PTC resistor; NRT 140°C (nominal response temperature)
Insulation class		F
Rating class to EN 60034-1		S1
Thermal class to EN 60034-1		F
Energy efficiency		ENEFF (CN) / Class 2
Relative humidity	[%]	0 ... 90 (non-condensing)
Corrosion resistance class CRC <sup>1)</sup>		2
CE marking (see declaration of conformity)		To EU Low Voltage Directive To EU EMC Directive <sup>2)</sup>
Certification		c UL us - Recognized (OL) RCM compliance mark
PWIS conformity		VDMA24364-B2-L
Note on materials		RoHS-compliant

1) Corrosion resistance class CRC 2 to Festo standard FN 940070

Moderate corrosion stress. Indoor applications in which condensation can occur. External visible parts with primarily decorative surface requirements which are in direct contact with a normal industrial environment.

2) For information about the area of use, see the EC declaration of conformity at: [www.festo.com/sp](http://www.festo.com/sp) → Certificates.

If the devices are subject to usage restrictions in residential, commercial or light-industrial environments, further measures for the reduction of the emitted interference may be necessary.

## Data sheet

### Pin allocation – Motor side

Motor with encoder

Flange size 140

Motor, (M23, pins)

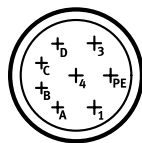

PIN	Function
1	U Phase
PE	PE Protective earthing
3	W Phase
4	V Phase
A	M <sub>T+</sub> Temperature sensor
B	M <sub>T-</sub> Temperature sensor
C	BR+ Brake
D	BR- Brake

Encoder (M12, pins)

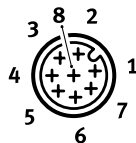

PIN	Function
1	-SENS
2	+SENS
3	DATA
4	DATA/
5	0 V
6	CLOCK/
7	CLOCK
8	UP

Flange size 190

Motor, (M40, pins)

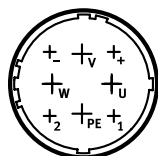

PIN	Function
U	U Phase
PE	PE Protective earthing
W	W Phase
V	V Phase
1	M <sub>T+</sub> Temperature sensor
2	M <sub>T-</sub> Temperature sensor
+	BR+ Brake
-	BR- Brake

Encoder (M12, pins)



PIN	Function
1	-SENS
2	+SENS
3	DATA
4	DATA/
5	0 V
6	CLOCK/
7	CLOCK
8	UP

## Data sheet

### Pin allocation – Motor side

Motor with resolver

Flange size 140

Motor, temperature sensor and brake (M23, pins)

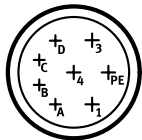

PIN	Function
1	U Phase
PE	PE Protective earthing
3	W Phase
4	V Phase
A	M <sub>T+</sub> Temperature sensor
B	M <sub>T-</sub> Temperature sensor
C	BR+ Brake
D	BR- Brake

Resolver (M23, pins)

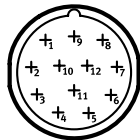

PIN	Function
1	R1 Exciter signal +
2	R2 Exciter signal -
3	S1 Cosine signal +
4	S3 Cosine signal -
5	S2 Sine signal +
6	S4 Sine signal -
7	n.c.
8	n.c.
9	n.c.
10	n.c.
11	n.c.
12	n.c.

Flange size 190

Motor, temperature sensor and brake (M40, pins)

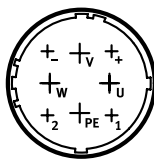

PIN	Function
U	U Phase
PE	PE Protective earthing
W	W Phase
V	V Phase
1	M <sub>T+</sub> Temperature sensor
2	M <sub>T-</sub> Temperature sensor
+	BR+ Brake
-	BR- Brake

Resolver (M23, pins)

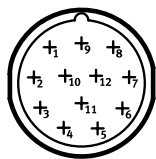

PIN	Function
1	R1 Exciter signal +
2	R2 Exciter signal -
3	S1 Cosine signal +
4	S3 Cosine signal -
5	S2 Sine signal +
6	S4 Sine signal -
7	n.c.
8	n.c.
9	n.c.
10	n.c.
11	n.c.
12	n.c.



## Data sheet

### Torque M as a function of rotational speed n

Flange size 140

Length S  
Winding HS

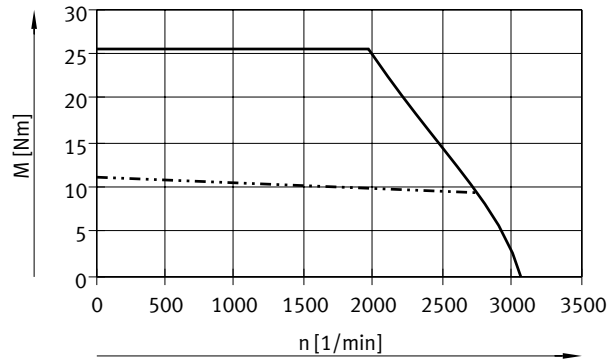

Length S  
Winding HV

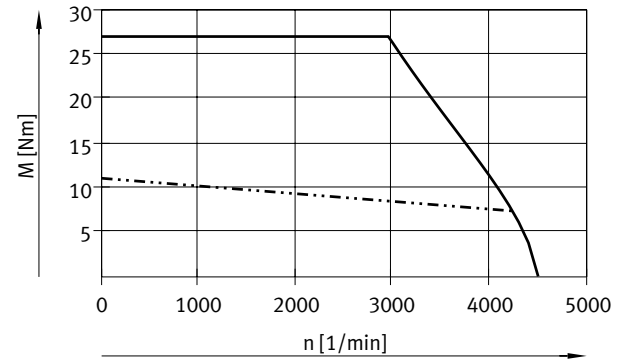

Length L  
Winding HS

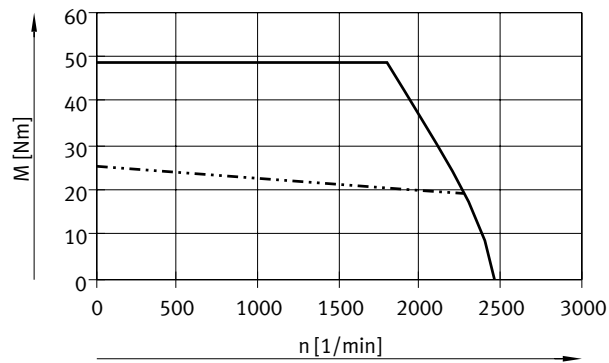

Length L  
Winding HV

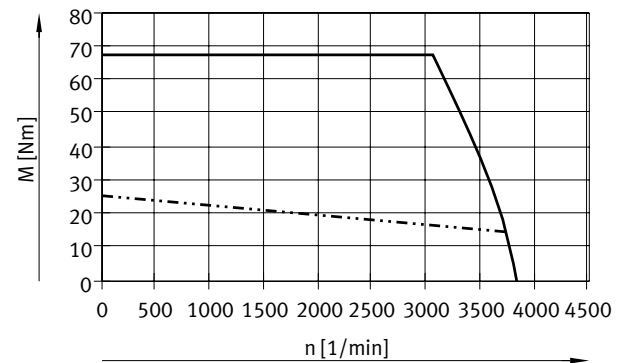

Flange size 190

Length S  
Winding HS

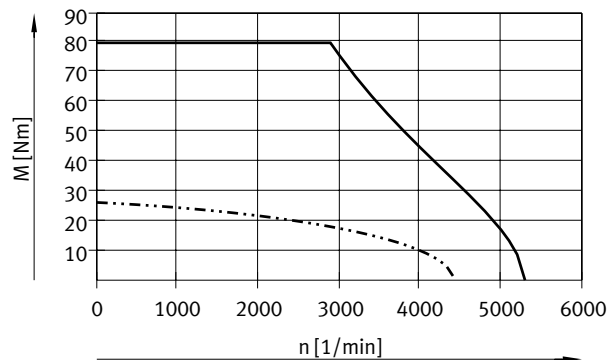

Length M  
Winding HS

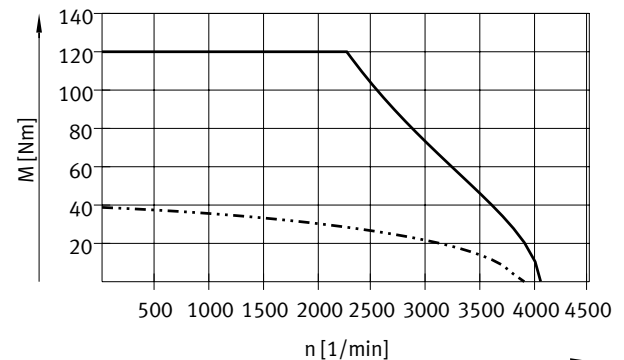

— Peak torque  
- · - · - Nominal torque

**Note**  
Typical motor characteristic curve with nominal voltage and optimal motor controller.

Data sheet

Dimensions

Download CAD data → [www.festo.com](http://www.festo.com)

Flange size 140, 190 – With encoder

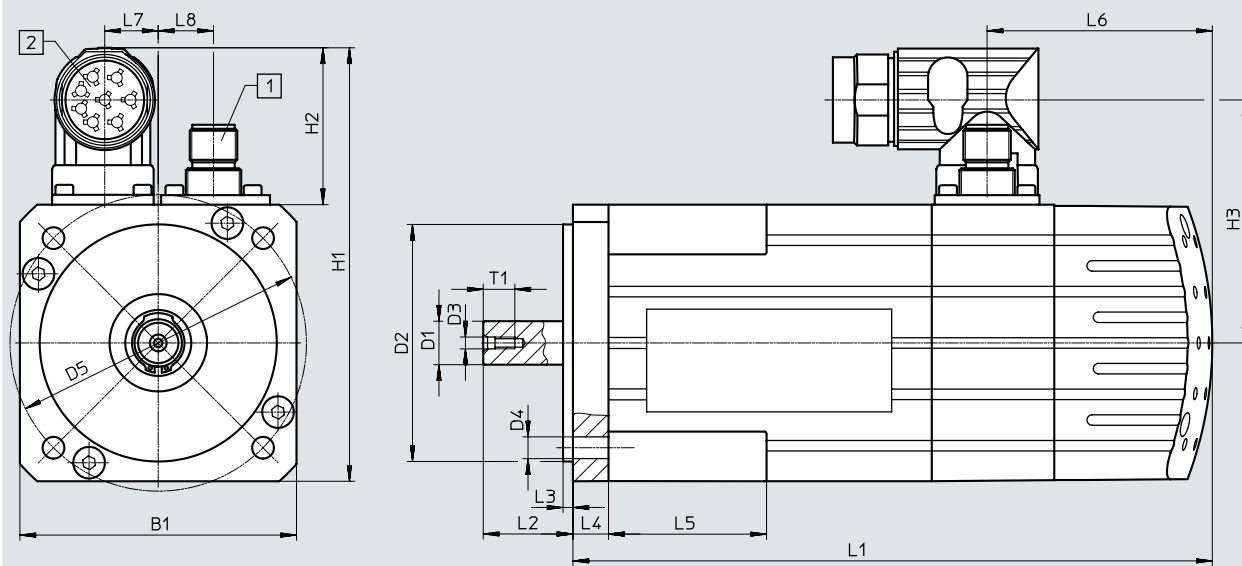

- [1] Encoder cable
- [2] Motor cable

Overall length	B1	D1 ø	D2 ø	D3	D4 ø	D5 ø	H1	H2	H3
<b>Flange size 140</b>									
S	140.5	24+0.015/-0.002	130+0.018/-0.007	M4	11.3	165	181	39.7	97.7
L									
<b>Flange size 190</b>									
S	190	32+0.018/+0.002	180+0.14/-0.011	M4	13.7	215	251	61	136
M									
Overall length	L1	L2	L3	L4	L5	L6	L7	L8	T1
<b>Flange size 140</b>									
S	209	50	3.5	12.2	-	58.6	33.5	33.5	16
L	285.5								
<b>Flange size 190</b>									
S	262	60	4 <sub>-0.1</sub>	11	-	81	25	33	16
M	300								

# Data sheet

## Dimensions

Download CAD data → [www.festo.com](http://www.festo.com)

Flange size 140, 190 – With resolver

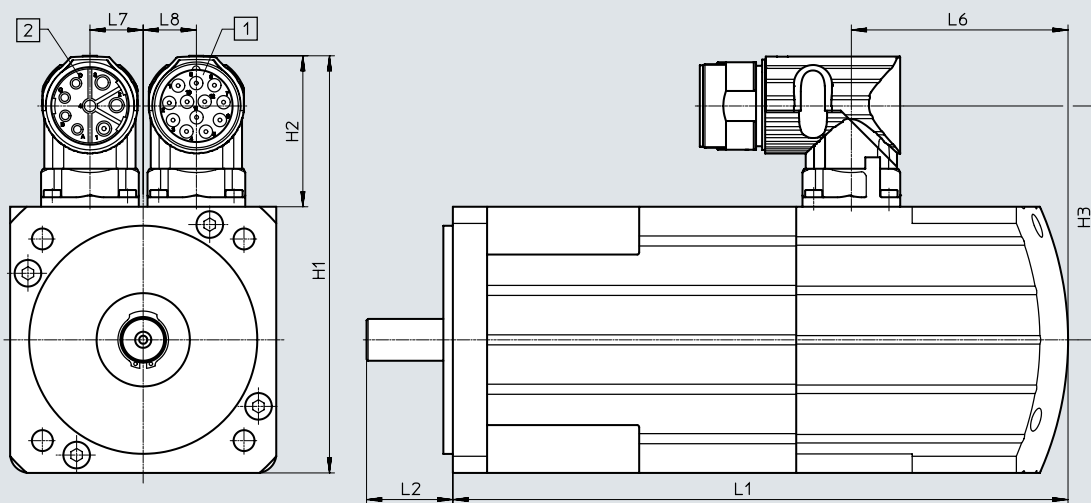

Flange size 190

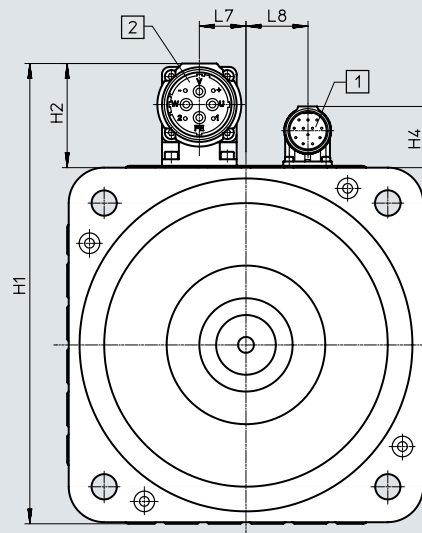

- [1] Resolver connection
- [2] Motor connection

**Note**

Dimensions of the shaft and mounting holes → drawing 18

Overall length	H1	H2	H3	H4	L1		L2	L6		L7	L8
						With brake			With brake		
<b>Flange size 140</b>											
S	180.2	39.7	96.8	-	194.6	209	50	44.2	58.6	33.5	33.5
L					271.1	285.5					
<b>Flange size 190</b>											
S	244	54	128.8	33	225	262	60	44	81	25	33
M					263	300					

**Note**

Only motors without feather key may be used in combination with parallel and axial kits (EAMM-U/EAMM-A).

Data sheet

Ordering data – Without featherkey												Part no.	Type
Overall length			Winding				Measuring unit			Brake	Degree of protection IP65 <sup>1)</sup> (with shaft seal)		
Short	Medium	Long	Low voltage, standard	Low voltage, speed optimised	High voltage, standard	High voltage, speed-optimised	Encoder, single-turn	Encoder, multi-turn	Resolver				
<b>Flange size 140</b>													
■					■		■					550131	EMMS-AS-140-S-HS-RS
■					■		■			■		550133	EMMS-AS-140-S-HS-RSB
■					■			■				550132	EMMS-AS-140-S-HS-RM
■					■			■				550134	EMMS-AS-140-S-HS-RMB
■					■				■			1574608	EMMS-AS-140-S-HS-RR
■					■				■	■		1574609	EMMS-AS-140-S-HS-RRB
■					■		■				■	1574616	EMMS-AS-140-S-HS-RS-S1
■					■		■			■	■	1574618	EMMS-AS-140-S-HS-RSB-S1
■					■			■			■	1574617	EMMS-AS-140-S-HS-RM-S1
■					■			■		■	■	1574619	EMMS-AS-140-S-HS-RMB-S1
■					■				■		■	1574620	EMMS-AS-140-S-HS-RR-S1
■					■				■	■	■	1574621	EMMS-AS-140-S-HS-RRB-S1
■						■	■					1574628	EMMS-AS-140-S-HV-RS
■						■	■			■		1574630	EMMS-AS-140-S-HV-RSB
■						■		■				1574629	EMMS-AS-140-S-HV-RM
■						■		■		■		1574631	EMMS-AS-140-S-HV-RMB
■						■			■			1574632	EMMS-AS-140-S-HV-RR
■						■			■	■		1574633	EMMS-AS-140-S-HV-RRB
■						■	■				■	1574640	EMMS-AS-140-S-HV-RS-S1
■						■	■			■	■	1574642	EMMS-AS-140-S-HV-RSB-S1
■						■		■			■	1574641	EMMS-AS-140-S-HV-RM-S1
■						■		■		■	■	1574643	EMMS-AS-140-S-HV-RMB-S1
■						■			■		■	1574644	EMMS-AS-140-S-HV-RR-S1
■						■			■	■	■	1574645	EMMS-AS-140-S-HV-RRB-S1
		■			■		■					550135	EMMS-AS-140-L-HS-RS
		■			■		■			■		550137	EMMS-AS-140-L-HS-RSB
		■			■			■				550136	EMMS-AS-140-L-HS-RM
		■			■			■		■		550138	EMMS-AS-140-L-HS-RMB
		■			■				■			1574656	EMMS-AS-140-L-HS-RR
		■			■				■	■		1574657	EMMS-AS-140-L-HS-RRB
		■			■		■				■	1574664	EMMS-AS-140-L-HS-RS-S1
		■			■		■			■	■	1574666	EMMS-AS-140-L-HS-RSB-S1
		■			■			■			■	1574665	EMMS-AS-140-L-HS-RM-S1
		■			■			■		■	■	1574667	EMMS-AS-140-L-HS-RMB-S1
		■			■				■		■	1574668	EMMS-AS-140-L-HS-RR-S1
		■			■				■	■	■	1574669	EMMS-AS-140-L-HS-RRB-S1
		■				■	■					1574676	EMMS-AS-140-L-HV-RS
		■				■	■			■		1574678	EMMS-AS-140-L-HV-RSB
		■				■		■				1574677	EMMS-AS-140-L-HV-RM
		■				■		■		■		1574679	EMMS-AS-140-L-HV-RMB
		■				■			■			1574680	EMMS-AS-140-L-HV-RR
		■				■			■	■		1574681	EMMS-AS-140-L-HV-RRB

1) For protection class IP65, special operating conditions must be observed for the shaft seal. Please consult your local Festo contact.

Products available ex-stock

# Data sheet

Ordering data – Without featherkey												Part no.	Type	
Overall length			Winding				Measuring unit			Brake	Degree of protection IP65 <sup>1)</sup> (with shaft seal)			
Short	Medium	Long	Low voltage, standard	Low voltage, speed optimised	High voltage, standard	High voltage, speed-optimised	Encoder, single-turn	Encoder, multi-turn	Resolver					
<b>Flange size 140</b>														
		■				■	■					■	1574688	EMMS-AS-140-L-HV-RS-S1
		■				■	■				■	■	1574690	EMMS-AS-140-L-HV-RSB-S1
		■				■		■				■	1574689	EMMS-AS-140-L-HV-RM-S1
		■				■		■			■	■	1574691	EMMS-AS-140-L-HV-RMB-S1
		■				■			■			■	1574692	EMMS-AS-140-L-HV-RR-S1
		■				■			■	■		■	1574693	EMMS-AS-140-L-HV-RRB-S1
<b>Flange size 190</b>														
■					■		■						1584908	EMMS-AS-190-S-HS-AS
■					■		■			■			1584911	EMMS-AS-190-S-HS-ASB
■					■			■					1584910	EMMS-AS-190-S-HS-AM
■					■			■		■			1584912	EMMS-AS-190-S-HS-AMB
■					■				■				1584913	EMMS-AS-190-S-HS-AR
■					■					■			1584914	EMMS-AS-190-S-HS-ARB
■					■		■				■		1584922	EMMS-AS-190-S-HS-AS-S1
■					■		■				■		1584924	EMMS-AS-190-S-HS-ASB-S1
■					■			■					1584923	EMMS-AS-190-S-HS-AM-S1
■					■			■		■			1584925	EMMS-AS-190-S-HS-AMB-S1
■					■				■				1584926	EMMS-AS-190-S-HS-AR-S1
■					■				■	■			1584927	EMMS-AS-190-S-HS-ARB-S1
	■				■		■						1584934	EMMS-AS-190-M-HS-AS
	■				■			■			■		1584936	EMMS-AS-190-M-HS-ASB
	■				■			■					1584935	EMMS-AS-190-M-HS-AM
	■				■			■		■			1584937	EMMS-AS-190-M-HS-AMB
	■				■				■				1584938	EMMS-AS-190-M-HS-AR
	■				■					■	■		1584939	EMMS-AS-190-M-HS-ARB
	■				■		■					■	1584946	EMMS-AS-190-M-HS-AS-S1
	■				■		■				■	■	1584948	EMMS-AS-190-M-HS-ASB-S1
	■				■			■				■	1584947	EMMS-AS-190-M-HS-AM-S1
	■				■			■		■		■	1584949	EMMS-AS-190-M-HS-AMB-S1
	■				■				■			■	1584950	EMMS-AS-190-M-HS-AR-S1
	■				■				■	■		■	1584951	EMMS-AS-190-M-HS-ARB-S1

1) For protection class IP65, special operating conditions must be observed for the shaft seal. Please consult your local Festo contact.

■ Products available ex-stock

Data sheet

Ordering data – With featherkey												Part no.	Type
Overall length			Winding				Measuring unit			Brake	Degree of protection IP65 <sup>1)</sup> (with shaft seal)		
Short	Medium	Long	Low voltage, standard	Low voltage, speed optimised	High voltage, standard	High voltage, speed-optimised	Encoder, single-turn	Encoder, multi-turn	Resolver				
<b>Flange size 140</b>													
■					■		■					560899	EMMS-AS-140-SK-HS-RS
■					■		■			■		560901	EMMS-AS-140-SK-HS-RSB
■					■			■				560900	EMMS-AS-140-SK-HS-RM
■					■			■		■		560902	EMMS-AS-140-SK-HS-RMB
■					■				■			1574614	EMMS-AS-140-SK-HS-RR
■					■				■	■		1574615	EMMS-AS-140-SK-HS-RRB
■					■			■			■	1574622	EMMS-AS-140-SK-HS-RS-S1
■					■			■		■	■	1574624	EMMS-AS-140-SK-HS-RSB-S1
■					■				■		■	1574623	EMMS-AS-140-SK-HS-RM-S1
■					■				■	■	■	1574625	EMMS-AS-140-SK-HS-RMB-S1
■					■				■		■	1574626	EMMS-AS-140-SK-HS-RR-S1
■					■				■	■	■	1574627	EMMS-AS-140-SK-HS-RRB-S1
■							■	■				1574634	EMMS-AS-140-SK-HV-RS
■							■	■			■	1574636	EMMS-AS-140-SK-HV-RSB
■							■		■			1574635	EMMS-AS-140-SK-HV-RM
■							■		■	■		1574637	EMMS-AS-140-SK-HV-RMB
■							■			■		1574638	EMMS-AS-140-SK-HV-RR
■							■			■	■	1574639	EMMS-AS-140-SK-HV-RRB
■							■	■			■	1574646	EMMS-AS-140-SK-HV-RS-S1
■							■	■		■	■	1574648	EMMS-AS-140-SK-HV-RSB-S1
■							■		■		■	1574647	EMMS-AS-140-SK-HV-RM-S1
■							■		■	■	■	1574649	EMMS-AS-140-SK-HV-RMB-S1
■							■			■	■	1574650	EMMS-AS-140-SK-HV-RR-S1
■							■			■	■	1574651	EMMS-AS-140-SK-HV-RRB-S1
		■			■		■					560903	EMMS-AS-140-LK-HS-RS
		■			■		■			■		560905	EMMS-AS-140-LK-HS-RSB
		■			■			■				560904	EMMS-AS-140-LK-HS-RM
		■			■			■		■		560906	EMMS-AS-140-LK-HS-RMB
		■			■				■			1574662	EMMS-AS-140-LK-HS-RR
		■			■				■	■		1574663	EMMS-AS-140-LK-HS-RRB
		■			■			■			■	1574670	EMMS-AS-140-LK-HS-RS-S1
		■			■			■		■	■	1574672	EMMS-AS-140-LK-HS-RSB-S1
		■			■				■		■	1574671	EMMS-AS-140-LK-HS-RM-S1
		■			■				■	■	■	1574673	EMMS-AS-140-LK-HS-RMB-S1
		■			■					■	■	1574674	EMMS-AS-140-LK-HS-RR-S1
		■			■					■	■	1574675	EMMS-AS-140-LK-HS-RRB-S1
		■					■	■				1574682	EMMS-AS-140-LK-HV-RS
		■					■	■		■		1574684	EMMS-AS-140-LK-HV-RSB
		■					■		■			1574683	EMMS-AS-140-LK-HV-RM
		■					■		■	■		1574685	EMMS-AS-140-LK-HV-RMB
		■					■			■		1574686	EMMS-AS-140-LK-HV-RR
		■					■			■	■	1574687	EMMS-AS-140-LK-HV-RRB
		■					■	■			■	1574694	EMMS-AS-140-LK-HV-RS-S1
		■					■	■		■	■	1574709	EMMS-AS-140-LK-HV-RSB-S1
		■					■		■		■	1574708	EMMS-AS-140-LK-HV-RM-S1
		■					■		■	■	■	1574710	EMMS-AS-140-LK-HV-RMB-S1
		■					■			■	■	1574711	EMMS-AS-140-LK-HV-RR-S1
		■					■			■	■	1574712	EMMS-AS-140-LK-HV-RRB-S1

1) For protection class IP65, special operating conditions must be observed for the shaft seal. Please consult your local Festo contact.

## Data sheet

Ordering data – With featherkey												Part no.	Type
Overall length			Winding				Measuring unit			Brake	Degree of protection IP65 <sup>1)</sup> (with shaft seal)		
Short	Medium	Long	Low voltage, standard	Low voltage, speed optimised	High voltage, standard	High voltage, speed-optimised	Encoder, single-turn	Encoder, multi-turn	Resolver				
<b>Flange size 190</b>													
■					■		■					1584915	EMMS-AS-190-SK-HS-AS
■					■		■			■		1584917	EMMS-AS-190-SK-HS-ASB
■					■			■				1584916	EMMS-AS-190-SK-HS-AM
■					■			■		■		1584918	EMMS-AS-190-SK-HS-AMB
■					■				■			1584919	EMMS-AS-190-SK-HS-AR
■					■				■	■		1584920	EMMS-AS-190-SK-HS-ARB
■					■		■				■	1584928	EMMS-AS-190-SK-HS-AS-S1
■					■		■			■	■	1584930	EMMS-AS-190-SK-HS-ASB-S1
■					■			■			■	1584929	EMMS-AS-190-SK-HS-AM-S1
■					■			■		■	■	1584931	EMMS-AS-190-SK-HS-AMB-S1
■					■				■		■	1584932	EMMS-AS-190-SK-HS-AR-S1
■					■				■	■	■	1584933	EMMS-AS-190-SK-HS-ARB-S1
	■				■		■					1584940	EMMS-AS-190-MK-HS-AS
	■				■		■			■		1584942	EMMS-AS-190-MK-HS-ASB
	■				■			■				1584941	EMMS-AS-190-MK-HS-AM
	■				■			■		■		1584943	EMMS-AS-190-MK-HS-AMB
	■				■				■			1584944	EMMS-AS-190-MK-HS-AR
	■				■				■	■		1584945	EMMS-AS-190-MK-HS-ARB
	■				■		■				■	1584952	EMMS-AS-190-MK-HS-AS-S1
	■				■		■			■	■	1584954	EMMS-AS-190-MK-HS-ASB-S1
	■				■			■			■	1584953	EMMS-AS-190-MK-HS-AM-S1
	■				■			■		■	■	1584955	EMMS-AS-190-MK-HS-AMB-S1
	■				■				■		■	1584956	EMMS-AS-190-MK-HS-AR-S1
	■				■				■	■	■	1584957	EMMS-AS-190-MK-HS-ARB-S1

1) For protection class IP65, special operating conditions must be observed for the shaft seal. Please consult your local Festo contact.

## Accessories

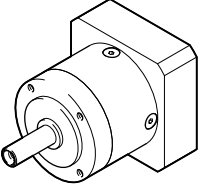
Ordering data – Gear unit		Data sheets → Internet: emga		
	For motor	Gear ratio	Part no.	Type
	EMMS-AS-140	3	552198	EMGA-120-P-G3-SAS-140
		5	552199	EMGA-120-P-G5-SAS-140
		8	8141759	EMGA-120-P-G8-SAS-140
		12	8141760	EMGA-120-P-G12-SAS-140
		20	8141761	EMGA-120-P-G20-SAS-140
		3	552200	EMGA-160-P-G3-SAS-140
		5	552201	EMGA-160-P-G5-SAS-140

Technical data – Cables		
Designation	Motor cable	
For motor	EMMS-AS-140	EMMS-AS-190
Type	NEBM-M23G8-...	NEBM-M40G8-...
Cable composition	2x (2x 0.5 mm <sup>2</sup> ) (8 A, 300 V, 2.5 KV)	2x (2x 0.75 mm <sup>2</sup> ) (12 A, 300 V, 2.5 KV)
	4 x 1.5 mm <sup>2</sup> (16 A, 630 V, 4.0 KV)	4 x 2.5 mm <sup>2</sup> (26 A, 630 V, 4.0 KV)
	Shielded	Shielded
Pollution degree	3	3
Min. bending radius [mm]	120	140
Ambient temperature [°C]	-50 ... +90	-50 ... +90
Ambient temperature <sup>1)</sup> [°C]	-40 ... +90	-40 ... +90
Cable characteristic	Suitable for use with energy chains	Suitable for use with energy chains
Degree of protection	IP65 (in assembled state)	IP65 (in assembled state)
Material	Polyurethane	Polyurethane
CE marking (see declaration of conformity)	To EU Low Voltage Directive	

Technical data – Cables		
Designation	Encoder cable	
For motor	EMMS-AS-140/190	
Type	NEBM-M12W8-...	
Cable composition	1x (4x 0.14 mm <sup>2</sup> ); (2 A; 30 V; 0.5 KV)	
	4 x 0.34 mm <sup>2</sup> (3 A; 30 V; 0.5 KV)	
	Shielded	
Pollution degree	3	
Min. bending radius [mm]	75	
Ambient temperature [°C]	-40 ... +80	
Ambient temperature <sup>1)</sup> [°C]	-10 ... +80	
Cable characteristic	Suitable for use with energy chains	
Degree of protection	IP65 (in assembled state)	
Material	Polyurethane	



## Accessories

Designation	Resolver cable	
For motor	EMMS-AS-140/190	
Type	NEBM-M23G12-...	
Cable composition	3x (2x 0.14 mm <sup>2</sup> )	
	2x 0.5 mm <sup>2</sup>	
	Shielded	
Pollution degree	3	
Min. bending radius	[mm]	98
Ambient temperature	[°C]	-50 ... +80
Ambient temperature <sup>1)</sup>	[°C]	-40 ... +75
Cable characteristic	Suitable for use with energy chains	
Degree of protection	IP65 (in assembled state)	
Material	Polyurethane	

1) With flexible cable installation

### Recommended cable cross section as a function of cable length $l$ and max. motor current $I_0$

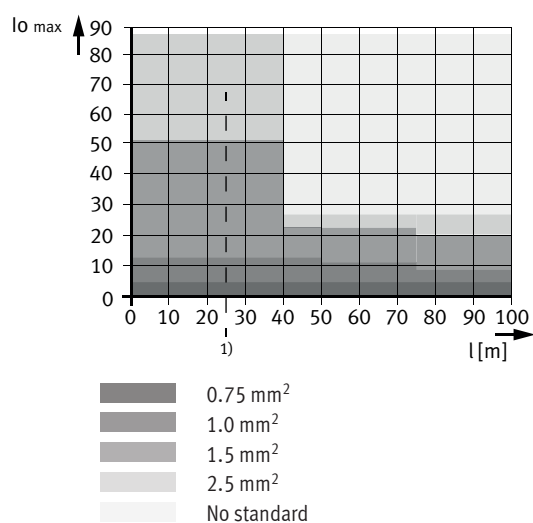

1) Cable lengths > 25 m possible following technical clarification; up to 99.9 m on request.

## Accessories

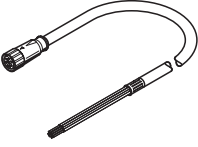
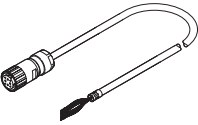
Ordering data		Cable length [m]	Part no.	Type
<b>Motor cable</b>				
	<b>For EMMS-AS-140 with CMMP-AS (cable cross section: 1.5 mm<sup>2</sup>)</b>			
	5	550310	NEBM-M23G8-E-5-Q9N-LE8	
	10	550311	NEBM-M23G8-E-10-Q9N-LE8	
	15	550312	NEBM-M23G8-E-15-Q9N-LE8	
	X length <sup>1)</sup>	550313	NEBM-M23G8-E-...-Q9N-LE8	
	<b>For EMMS-AS-140 with CMMT-AS (cable cross section: 1.5 mm<sup>2</sup>)</b>			
	5	5391141	NEBM-M23G8-E-5-Q9N-LE8-1	
	10	5391144	NEBM-M23G8-E-10-Q9N-LE8-1	
	15	5391139	NEBM-M23G8-E-15-Q9N-LE8-1	
X length <sup>1)</sup>	5391145	NEBM-M23G8-E-...-Q9N-LE8-1		
	<b>For EMMS-AS-190 with CMMP-AS (cable cross section: 2.5 mm<sup>2</sup>)</b>			
	5	1750241	NEBM-M40G8-E-5-Q10N-LE8	
	10	1750242	NEBM-M40G8-E-10-Q10N-LE8	
	15	1750243	NEBM-M40G8-E-15-Q10N-LE8	
	X length <sup>1)</sup>	1750244	NEBM-M40G8-E-...-Q10N-LE8	
	<b>For EMMS-AS-190 with CMMT-AS (cable cross section: 2.5 mm<sup>2</sup>)</b>			
	5	8085961	NEBM-M40G8-E-5-Q10N-LE8-1	
	10	8085960	NEBM-M40G8-E-10-Q10N-LE8-1	
	15	8085962	NEBM-M40G8-E-15-Q10N-LE8-1	
X length <sup>1)</sup>	8085959	NEBM-M40G8-E-...-Q10N-LE8-1		

1) Choice of cable lengths: 0.5 ... 99.9 m, in increments of 0.1 m.

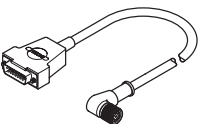
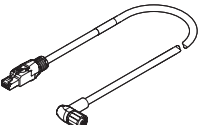
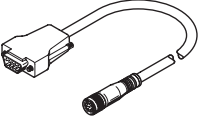
Ordering data		Cable length [m]	Part no.	Type
<b>Encoder cable</b>				
	<b>For EMMS-AS-140/190 with CMMP-AS</b>			
	5	550318	NEBM-M12W8-E-5-N-S1G15	
	10	550319	NEBM-M12W8-E-10-N-S1G15	
	15	550320	NEBM-M12W8-E-15-N-S1G15	
	X length <sup>1)</sup>	550321	NEBM-M12W8-E-...-N-S1G15	
	<b>For EMMS-AS-140/190 with CMMT-AS</b>			
	5	5213423	NEBM-M12W8-E-5-N-R3G8	
	10	5213425	NEBM-M12W8-E-10-N-R3G8	
	15	5213426	NEBM-M12W8-E-15-N-R3G8	
	X length <sup>1)</sup>	5213428	NEBM-M12W8-E-...-N-R3G8	
<b>Resolver cable for CMMP-AS only</b>				
	<b>For EMMS-AS-140/190</b>			
	5	1732653	NEBM-M23G12-E-5-N-S1G9	
	10	1732654	NEBM-M23G12-E-10-N-S1G9	
	15	1732655	NEBM-M23G12-E-15-N-S1G9	
	X length <sup>1)</sup>	1732656	NEBM-M23G12-E-...-N-S1G9	

1) Choice of cable lengths: 0.5 ... 99.9 m, in increments of 0.1 m.

 **Note**

Cable lengths > 25 m possible following technical clarification.  
In the case of motors with a holding brake, the max. cable length is 50 m.

# Festo - Your Partner in Automation



**1 Festo Inc.**  
5300 Explorer Drive  
Mississauga, ON L4W 5G4  
Canada

**Festo Customer Interaction Center**  
Tel: 1 877 463 3786  
Fax: 1 877 393 3786  
Email: [customer.service.ca@festo.com](mailto:customer.service.ca@festo.com)



**2 Festo Pneumatic**  
Av. Ceylán 3,  
Col. Tequesquináhuac  
54020 Tlalneantla,  
Estado de México

**Multinational Contact Center**  
01 800 337 8669  
[ventas.mexico@festo.com](mailto:ventas.mexico@festo.com)



**3 Festo Corporation**  
1377 Motor Parkway  
Suite 310  
Islandia, NY 11749

**Festo Customer Interaction Center**  
1 800 993 3786  
1 800 963 3786  
[customer.service.us@festo.com](mailto:customer.service.us@festo.com)



**4 Regional Service Center**  
7777 Columbia Road  
Mason, OH 45040

Connect with us



[www.festo.com/socialmedia](http://www.festo.com/socialmedia)



[www.festo.com](http://www.festo.com)

Subject to change