

Spindle axes EGC-BS-KF, with recirculating ball bearing guide

FESTO



Festo core product range
Covers 80% of your automation tasks

Worldwide:

Always in stock

Superb:

Festo quality at an attractive price

Easy:

Simplified procurement and warehousing

★ Generally ready for shipping ex works in 24 hours

In stock at 13 Service Centres worldwide

More than 2200 products

☆ Generally ready for shipping ex works in 5 days

Assembled for you at 4 Service Centres worldwide

Up to 6×10^{12} variants per product family

Just look
for the
star!

Selection aid

Overview of toothed belt and spindle axes

Toothed belt axes

- Speeds of up to 10 m/s
- Acceleration of up to 50 m/s²
- Repetition accuracy of up to ±0.08 mm
- Strokes of up to 8500 mm (longer strokes on request)
- Flexible motor mountings

Spindle axes

- Speeds of up to 2 m/s
- Acceleration of up to 20 m/s²
- Repetition accuracy of up to ±0.003 mm
- Strokes of up to 3000 mm

Coordinate system

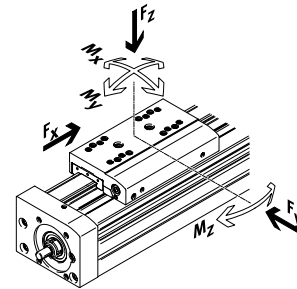

Toothed belt axes

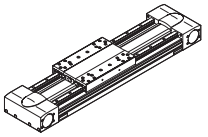
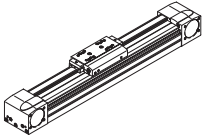
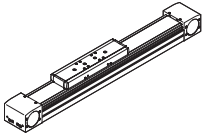
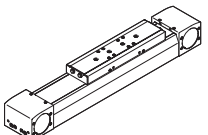
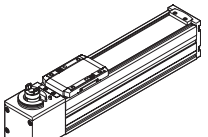
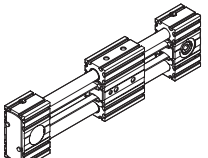
Type	F _x [N]	v [m/s]	M _x [Nm]	M _y [Nm]	M _z [Nm]	Characteristics
Heavy-duty recirculating ball bearing guide						
EGC-HD-TB						
	450 1000 1800	3 5 5	140 300 900	275 500 1450	275 500 1450	<ul style="list-style-type: none"> • Flat drive unit with rigid, closed profile • Precision DUO guide rail with high load capacity • Ideal as a base axis for linear gantries and cantilever axes
Recirculating ball bearing guide						
EGC-TB-KF						
	50 100 350 800 2500	3 5 5 5 5	3.5 16 36 144 529	10 132 228 680 1820	10 132 228 680 1820	<ul style="list-style-type: none"> • Rigid, closed profile • Precision guide rail with high load capacity • Small drive pinions reduce required driving torque • Space-saving position sensing
ELGA-TB-KF						
	350 800 1300 2000	5 5 5 5	16 36 104 167	132 228 680 1150	132 228 680 1150	<ul style="list-style-type: none"> • Internal guide and toothed belt • Precision guide rail with high load capacity • Guide and toothed belt protected by cover strip • High feed forces
ELGA-TB-KF-F1						
	260 600 1000	5 5 5	16 36 104	132 228 680	132 228 680	<ul style="list-style-type: none"> • Suitable for use in the food zone • "Clean look": smooth, easy-to-clean surfaces • Internal guide and toothed belt • Precision guide rail with high load capacity • Guide and toothed belt protected by cover strip
ELGC-TB-KF						
	75 120 250	1.2 1.5 1.5	5.5 29.1 59.8	4.7 31.8 56.2	4.7 31.8 56.2	<ul style="list-style-type: none"> • Internal guide and toothed belt • Precision guide rail with high load capacity • Guide and toothed belt protected by cover strip
ELGR-TB						
	50 100 350	3 3 3	2.5 5 15	20 40 124	20 40 124	<ul style="list-style-type: none"> • Cost-optimised rod guide • Ready-to-install unit • Linear ball bearings with high load capacity for dynamic operation

Selection aid

Overview of toothed belt and spindle axes

Toothed belt axes

- Speeds of up to 10 m/s
- Acceleration of up to 50 m/s²
- Repetition accuracy of up to ±0.08 mm
- Strokes of up to 8500 mm (longer strokes on request)
- Flexible motor mountings

Spindle axes

- Speeds of up to 2 m/s
- Acceleration of up to 20 m/s²
- Repetition accuracy of up to ±0.003 mm
- Strokes of up to 3000 mm

Coordinate system

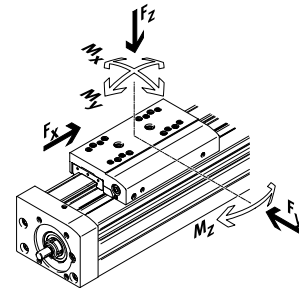

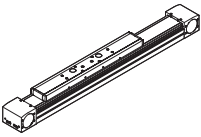
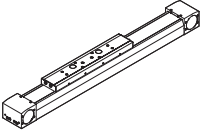
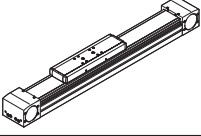
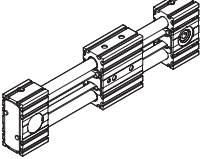
Toothed belt axes						
Type	F_x [N]	v [m/s]	M_x [Nm]	M_y [Nm]	M_z [Nm]	Characteristics
Roller bearing guide						
ELGA-TB-RF						
	350 800 1300	10 10 10	11 30 100	40 180 640	40 180 640	<ul style="list-style-type: none"> • Heavy-duty roller bearing guide • Guide and toothed belt protected by cover strip • Speeds of up to 10 m/s • Lower weight than axes with guide rails
ELGA-TB-RF-F1						
	260 600 1000	10 10 10	8.8 24 80	32 144 512	32 144 512	<ul style="list-style-type: none"> • Suitable for use in the food zone • "Clean look": smooth, easy-to-clean surfaces • Heavy-duty roller bearing guide • Guide and toothed belt protected by cover strip • Lower weight than axes with guide rails
Plain-bearing guide						
ELGA-TB-G						
	350 800 1300	5 5 5	5 10 120	30 60 120	10 20 40	<ul style="list-style-type: none"> • Guide and toothed belt protected by cover strip • For simple handling tasks • As a drive component for external guides • Insensitive to harsh ambient conditions
ELGR-TB-GF						
	50 100 350	1 1 1	1 2.5 1	10 20 40	10 20 40	<ul style="list-style-type: none"> • Cost-optimised rod guide • Ready-to-install unit • Heavy-duty plain bearings for use in harsh ambient conditions

Selection aid

Overview of toothed belt and spindle axes

Toothed belt axes

- Speeds of up to 10 m/s
- Acceleration of up to 50 m/s²
- Repetition accuracy of up to ±0.08 mm
- Strokes of up to 8500 mm (longer strokes on request)
- Flexible motor mountings

Spindle axes

- Speeds of up to 2 m/s
- Acceleration of up to 20 m/s²
- Repetition accuracy of up to ±0.003 mm
- Strokes of up to 3000 mm

Coordinate system

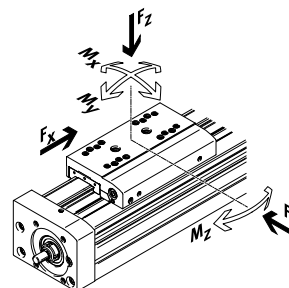

Spindle axes

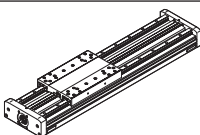
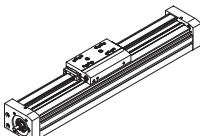
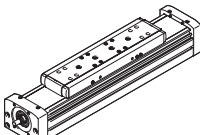
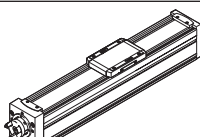
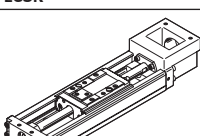
Type	F_x [N]	v [m/s]	M_x [Nm]	M_y [Nm]	M_z [Nm]	Characteristics
Heavy-duty recirculating ball bearing guide						
EGC-HD-BS						
	400 650 1500	0.5 1.0 1.5	140 300 900	275 500 1450	275 500 1450	<ul style="list-style-type: none"> • Flat drive unit with rigid, closed profile • Precision DUO guide rail with high load capacity • Ideal as a base axis for linear gantries and cantilever axes
Recirculating ball bearing guide						
EGC-BS-KF						
	400 650 1500 3000	0.5 1.0 1.5 2.0	16 36 144 529	132 228 680 1820	132 228 680 1820	<ul style="list-style-type: none"> • Rigid, closed profile • Precision guide rail with high load capacity • For the highest requirements in terms of feed force and accuracy • Space-saving position sensing
ELGA-BS-KF						
	650 1600 3400 6400	0.5 1.0 1.5 2.0	16 36 104 167	132 228 680 1150	132 228 680 1150	<ul style="list-style-type: none"> • Internal guide and ball screw • Precision guide rail with high load capacity • For the highest requirements in terms of feed force and accuracy • Guide and ball screw protected by cover strip • Space-saving position sensing
ELGC-BS-KF						
	40 100 200 350	0.6 0.6 0.8 1.0	1.3 5.5 29.1 59.8	1.1 4.7 31.8 56.2	1.1 4.7 31.8 56.2	<ul style="list-style-type: none"> • Internal guide and ball screw • Guide and ball screw protected by cover strip • Space-saving position sensing
EGSK						
	57 133 184 239 392	0.33 1.10 0.83 1.10 1.48	13 28.7 60 79.5 231	3.7 9.2 20.4 26 77.3	3.7 9.2 20.4 26 77.3	<ul style="list-style-type: none"> • Spindle axes with maximum precision, compactness and rigidity • Recirculating ball bearing guide and ball screw without caged ball bearings • Standard designs in stock

Key features

At a glance

Powerful

- Generously sized profiles with an optimised cross section enable maximum rigidity and load capacity
- Speed, acceleration and torque resistance set a new standard

Economical

- In addition to its technical data, the spindle axis also offers an excellent price/performance ratio
- Due to the EGC's high performance it is often possible to use a smaller size

Versatile

- Different spindle pitches, numerous sizes and variants such as protected guides open up a broad range of applications
- Space-saving position sensing possible via proximity switch in the profile slot
- Wide range of options for mounting on drives
- Comprehensive range of mounting accessories for multi-axis combinations
- Spindle support enables maximum travel speed with all stroke lengths

Characteristic values of the axes

The specifications shown in the table are maximum values.

The precise values for each of the variants can be found in the relevant data sheet in the catalogue.

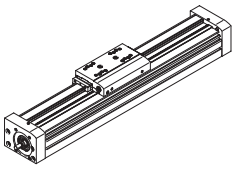
Design	Size	Working stroke [mm]	Speed [m/s]	Repetition accuracy [mm]	Max. feed force [N]	Guide characteristics				
						Forces and torques				
						F _y [N]	F _z [N]	M _x [Nm]	M _y [Nm]	M _z [Nm]
Recirculating ball bearing guide										
	70	50 ... 1000	0.5	±0.02	400	1850	1850	16	132	132
	80	50 ... 2000	1.0	±0.02	650	3050	3050	36	228	228
	120	50 ... 2500	1.5	±0.02	1500	6890	6890	144	680	680
	185	50 ... 3000	2.0	±0.02	3000	15200	15200	529	1820	1820

Note

Engineering software

Electric Motion Sizing

www.festo.com/x/electric-motion-sizing

Key features

Slide variants

Standard slide



Extended slide



Additional slide



Guide options

Protected version



- The protected guide cleans the guide rail while the additional wiper seal protects the recirculating ball bearing guide

With central lubrication

→ Page 25



- The lubrication adapter enables the guide and the spindle to be permanently lubricated using semi or fully automatic relubrication devices
- The adapters are suitable for oils and greases
- All lubrication connections must be connected

Displacement encoder

→ Page 14

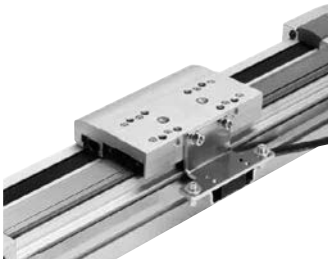

- The position of the slide can be sensed directly when using the incremental displacement encoder. This means that all elasticities of the drivetrain can be detected and corrected by the motor controller.

Clamping unit

→ Page 15



- 1- or 2-channel design, for holding loads
- Reliable holding is guaranteed since the forces act directly on the slide
- A limited number of emergency braking operations are permissible with sizes 120 and 185

Key features

Complete system comprising spindle axis, motor, motor controller and motor mounting kit

Spindle axis with recirculating ball bearing guide



Motor

→ Page 52



Servo motor:
EMMT-AS, EMME-AS
Stepper motor:
EMMS-ST



Note

A range of specially adapted complete solutions is available for the spindle axis EGC and the motors.

Servo drives



Servo drive:
CMMT-AS
Servo drive for extra-low voltage:
CMMT-ST

Motor mounting kit

Axial kit → Page 52

Parallel kit → page 56

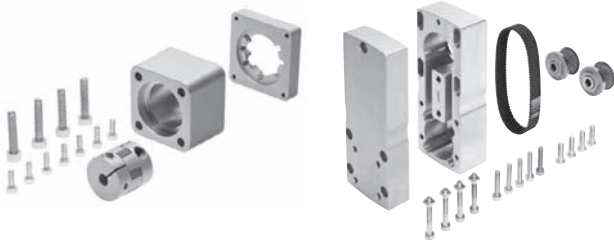

Peripherals overview

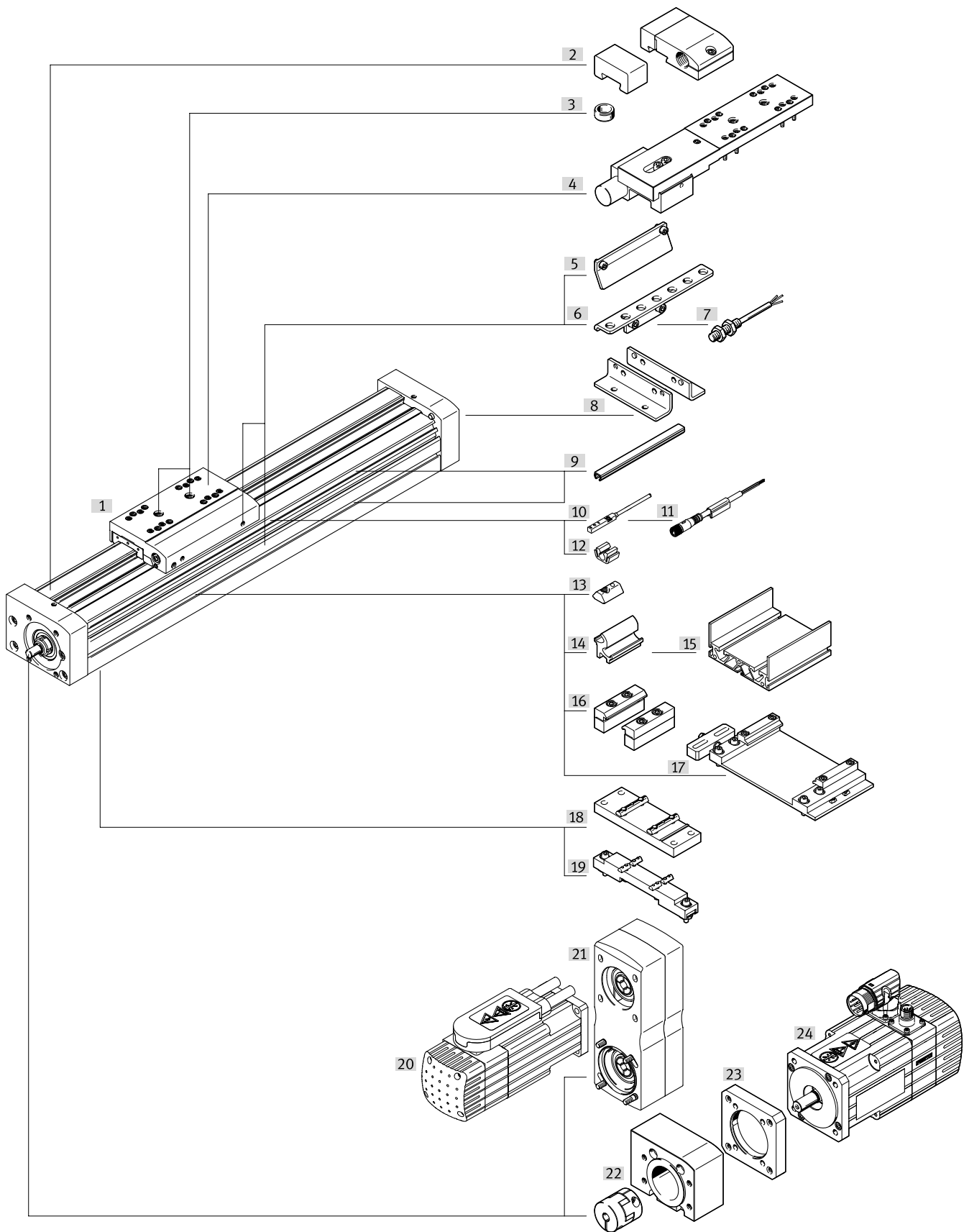

Peripherals overview

Variants and accessories			
Type/order code	Description		→ Page/Internet
[1] Spindle axis EGC-BS-KF	Electric drive		10
[2] Emergency buffer with retaining bracket A	For avoiding damage at the end stop in the event of a malfunction		65
[3] Centring pin/sleeve ZBS, ZBH	<ul style="list-style-type: none"> For centring loads and attachments on the slide Included in the scope of delivery: <ul style="list-style-type: none"> With size 70: 2x ZBS-5 With size 80, 120, 185: 2x ZBH-9 		65
[4] Clamping unit 1H...PN, 2H-PN	For holding loads		15
[5] Switch lug X, Z, O, P, W, R	For sensing the slide position		63
[6] Sensor bracket O, P, W, R	Adapter for mounting the inductive proximity switches (round design) on the axis		64
[7] Proximity switch, M8 O, P, W, R	<ul style="list-style-type: none"> Inductive proximity switch, round design The order code O, P, W, R includes 1 switch lug and max. 2 sensor brackets in the scope of delivery 		66
[8] Foot mounting F	For mounting the axis on the end cap (only possible at one end)		58
[9] Slot cover B, S	<ul style="list-style-type: none"> For protection against contamination 		65
[10] Proximity switch, T-slot X, Z	<ul style="list-style-type: none"> Inductive proximity switch, for T-slot The order code X, Z includes 1 switch lug in the scope of delivery 		66
[11] Connecting cable V	For proximity switch (order code W and R)		67
[12] Clip CL	For mounting the proximity switch cable in the slot		65
[13] Slot nut Y	For mounting attachments		65
[14] Adapter kit DHAM	For mounting the support profile on the axis		66
[15] Support profile HMIA	For mounting and guiding an energy chain		66
[16] Profile mounting M	For mounting the axis on the side of the profile		59
[17] Adjusting kit EADC-E16	For mounting the axis on a vertical surface. Once mounted, the axis can be aligned horizontally		62
[18] Central support EAHF-L5	For mounting the axis on the profile from underneath		60
[19] Adjusting kit EADC-E15	Height-adjustable. Can be used to easily compensate for any unevenness in the bearing surface		61
[20] Motor EMME, EMMS	Motors specially matched to the axis, with or without brake		52
[21] Parallel kit EAMM-U	For parallel motor mounting (comprising: housing, clamping sleeve, toothed belt pulley, toothed belt)		56
[22]/ [23] Axial kit EAMM-A	For axial motor mounting (comprising: coupling, coupling housing and motor flange)		52
[24] Motor EMME, EMMS	Motors specially matched to the axis, with or without brake		52
- Guide axis EGC-FA	Axis without drive		egc-fa

Type codes

001	Series	
EGC	Electric linear axis	
002	Size	
70	70	
80	80	
120	120	
185	185	
003	Stroke range [mm]	
...	50 ... 3000	
004	Drive system	
BS	Ball screw drive	
005	Spindle pitch	
10P	10 mm	
20P	20 mm	
25P	25 mm	
40P	40 mm	
006	Spindle support	
	None	
S	With	
007	Guide	
KF	Recirculating ball bearing guide	
008	Stroke reserve [mm]	
...	0 ... 999	
009	Motor attachment position	
ML	Left	
MR	Right	
010	Slide	
GK	Standard slide	
GP	Standard slide, protected	
GV	Extended slide	
GQ	Extended slide, protected	
011	Additional slide left	
	None	
KL	Additional slide, standard, left	
012	Additional slide, right	
	None	
KR	Additional slide standard, right	
013	Lubrication function	
	None	
C	Lubrication adapter	
014	Displacement encoder	
	None	
M1	With displacement encoder, incremental, resolution 2.5 µm	
M2	With displacement encoder, incremental, resolution 10 µm	

015	Clamping unit	
	None	
1HL	Holding function, 1-channel, left	
1HR	Single-channel holding function, right	
2H	Holding function, 2-channel	
016	Actuation type	
	None	
PN	Pneumatically actuated	
017	Foot mounting	
	None	
F	1 record	
018	Profile mounting	
	None	
...M	1 - 50 pieces	
019	Slot cover, mounting slot	
	Without	
...B	1 - 50 pieces	
020	Slot cover, sensor slot	
	Without	
...S	1 - 50 pieces	
021	Slot nut, mounting slot	
	Without	
...Y	1 ... 99 pieces	
022	Proximity switch, inductive, slot 8, PNP, N/O contact, cable 7.5 m	
	None	
...X	1 ... 6 pieces	
023	Proximity switch, inductive, slot 8, N/C contact, cable 7.5 m	
	None	
...Z	1 ... 6 pieces	
024	Emergency buffer with retaining bracket	
	Without	
...A	1 ... 2 pieces	
025	Proximity switch, inductive, M8, PNP, N/O contact, cable 2.5 m	
	Without	
...O	1 ... 99 pieces	
026	Proximity switch, inductive, M8, PNP, N/C contact, cable 2.5 m	
	None	
...P	1 ... 99 pieces	
027	Proximity switch, inductive, M8, PNP, N/C contact, M8 plug	
	None	
...R	1 ... 99 pieces	
028	Proximity switch, inductive, M8, PNP, N/O contact, M8 plug	
	Without	
...W	1 ... 99 pieces	
029	Connecting cable 2.5 m, M8, 3-wire	
	None	
...V	1 ... 99 pieces	



Type codes

030	Cable clip	
	None	
10CL	10 pieces	
20CL	20 pieces	
30CL	30 pieces	
40CL	40 pieces	

030	Cable clip	
50CL	50 pieces	
60CL	60 pieces	
70CL	70 pieces	
80CL	80 pieces	
90CL	90 pieces	

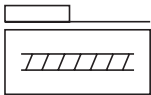
Data sheet



-  - Size
70 ... 185
-  - Stroke length
50 ... 3000 mm
-  - www.festo.com



General technical data							
Size		70	80		120		185
Spindle pitch	[mm/rev]	10	10	20	10	25	40
Design		Electromechanical axis with ball screw					
Guide		Recirculating ball bearing guide					
Mounting position		Any					
Working stroke							
EGC-...-GK/-GP	[mm]	50 ... 1000	50 ... 2000		50 ... 2500		50 ... 3000
EGC-...-GV/-GQ	[mm]	50 ... 900	50 ... 1900		50 ... 2400		50 ... 2900
Max. feed force $F_x^{1)}$	[N]	400	650		1500		3000
No-load torque at low travel speed	[Nm]	0.17	0.3	0.35	1.0	1.0	2.2
	[m/s]	0.05	0.1	0.1	0.2	0.2	0.2
No-load torque at max. travel speed	[Nm]	0.45	0.75	0.75	2.25	2.25	6.5
	[m/s]	0.5	0.5	1	0.6	1.5	2
Max. radial force ²⁾	[N]	220	250		500		4000
Max. rotational speed ³⁾	[rpm]	3000	3000		3600		3000
Max. acceleration	[m/s ²]	15					
Repetition accuracy	[mm]	±0.02					

- 1) The feed force affects the service life. (→ Page 18)
- 2) At the driving shaft
- 3) Rotational speed and velocity are stroke-dependent

Operating and environmental conditions		
Ambient temperature	[°C]	-10 ... +60
Degree of protection		IP40
Duty cycle	[%]	100

Data sheet

Weight [g]				
Size	70	80	120	185
Basic weight with 0 mm stroke ¹⁾				
EGC-...-GK/-GP	1500	2700	12500	30000
EGC-...-GV/-GQ	2000	3500	14400	34500
Additional weight per 10 mm stroke	50	80	190	390
Moving mass				
EGC-...-GK/-GP	400	740	2400	8600
EGC-...-GV/-GQ	600	950	2900	9850
Additional slide				
EGC-...-KL/-KR	300	550	2000	6000
Clamping unit				
EGC-...-1H...-PN	-	700	2300	4900
EGC-...-2H-PN	-	1300	4000	8300

1) Incl. slide

Spindle						
Size	70	80	120	185		
Diameter [mm]	12	15	25	40		
Pitch [mm/rev]	10	10	20	10	25	40

Mass moment of inertia						
Size	70	80	120	185		
Spindle pitch [mm/rev]	10	10	20	10	25	40
J_0						
EGC-...-GK [kg mm ²]	1.99	5.2	5.2	64.46	64.46	594
EGC-...-GV [kg mm ²]	3.41	8.67	8.68	92	92	774.71
J_H per metre stroke [kg mm ² /m]	14.2	34.6	34.6	275.6	275.6	1803.1
J_L per kg payload [kg mm ² /kg]	2.53	2.53	10.13	2.53	15.83	40.53
J_W slide						
EGC-...-GK [kg mm ²]	1.04	1.86	7.46	6.09	38.06	348.87
EGC-...-GV [kg mm ²]	1.48	2.34	9.35	7.34	45.85	399.08
J_F Clamping unit						
EGC-...-1H...-PN [kg mm ²]	-	1.78	7.1	5.8	36.4	198.5
EGC-...-2H-PN [kg mm ²]	-	3.3	13.2	10	63.3	336.4

The mass moment of inertia J_A of the entire axis is calculated as follows:

$$J_A = J_0 + \Sigma J_W + J_H \times \text{working stroke [m]} + J_L \times m_{\text{payload}} [\text{kg}] + J_F$$

ΣJ_W = Total mass moment of inertia of all slides, including the first slide

Data sheet

Materials

Sectional view

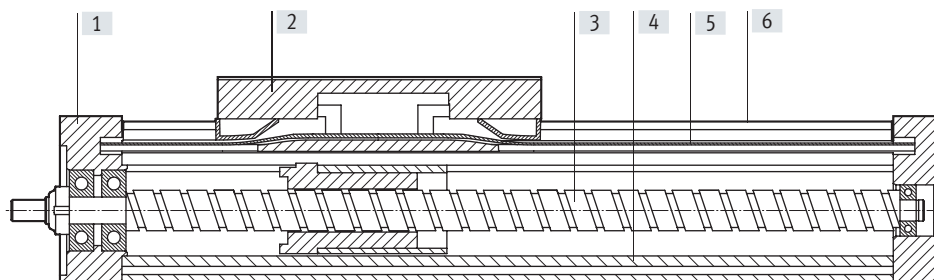

Axis

[1]	End cap	Anodised wrought aluminium alloy
[2]	Slide	Anodised wrought aluminium alloy
[3]	Spindle	Steel
[4]	Profile	Anodised aluminium
[5]	Cover strip	Polyurethane
[6]	Guide rail	High-alloy steel
Note on materials		RoHS-compliant

Technical data – Displacement encoder

Dimensions → page 43

Type	EGC-...-M1	EGC-...-M2
Resolution	2.5	10
Max. travel speed with displacement encoder	4	4
Encoder signal	5 V TTL; A/A, B/B; reference signal (N/N) cyclically every 5 mm (zero pulse)	
Signal output	Line driver, alternating, resistant to sustained short circuit	
Electrical connection	8-pin plug, round design, M12	
Cable length	160	

Operating and environmental conditions – Displacement encoder system

Ambient temperature	[-10 ... +70 °C]
Degree of protection	IP64
CE marking (see declaration of conformity)	To EU EMC Directive ¹⁾

1) For information about the area of use, see the EC declaration of conformity at: www.festo.com/sp → Certificates.

If the devices are subject to usage restrictions in residential, commercial or light-industrial environments, further measures for the reduction of the emitted interference may be necessary.

Application information

- The displacement encoder contains paint-wetting impairment substances.
- The spindle axis with displacement encoder is not designed for the following application examples:

- Magnetic field

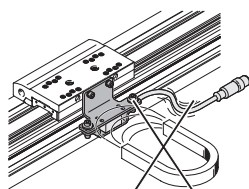

- Welding application

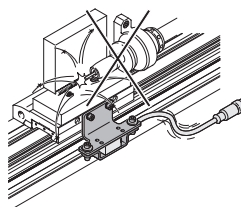

Data sheet

Technical data – Clamping unit		Dimensions → page 44		
Size		80	120	185
Pneumatic connection		M5	M5	M5
Clamping type		Clamping via spring force, compressed air to release		
Static holding force				
EGC-...-1H...-PN	[N]	320	1200	1500
EGC-...-2H...-PN	[N]	640	2400	3000
Max. number of emergency braking operations ¹⁾ at reference energy	[J]	–	750 35	750 70
Number of clamping operations under rated load	[millions of switching cycles]	0.45	0.05	> 1.4

1) Emergency braking refers to braking the payload if the drive axis loses power.

Operating and environmental conditions – Clamping unit	
Operating medium	Compressed air to ISO 8573-1:2010 [7:4:4]
Operating pressure	
Clamping unit open	[bar] 4.5 ... 8
Clamping unit closed	[bar] Unpressurised
Ambient temperature	[°C] –10 ... +60

**Note**

The axis can only be relubricated with the lubrication adapter (EGC-...-C) when used in combination with the clamping unit.

Data sheet

Characteristic load values

The indicated forces and torques refer to the slide surface. The point of application of force is the point where the centre of the guide and the longitudinal centre of the slide intersect. These values must not be exceeded during dynamic operation. Special attention must be paid to the deceleration phase.

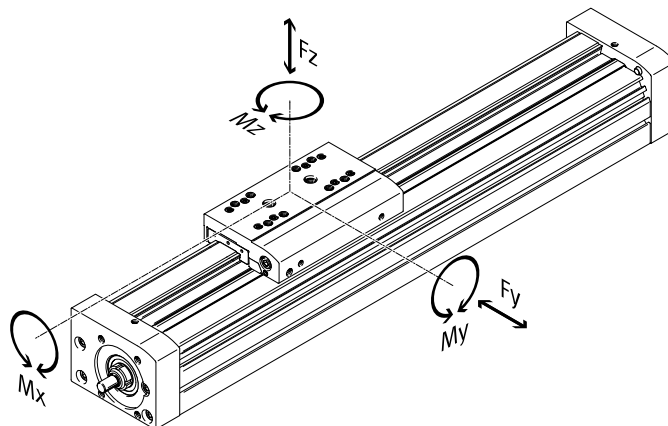

Max. permissible forces and torques for a service life of 5000 km

Size		70	80	120	185
$F_{y_{max}}$	[N]	1850	3050	6890	15200
$F_{z_{max}}$	[N]	1850	3050	6890	15200
$M_{x_{max}}$	[Nm]	16	36	144	529
$M_{y_{max}}/M_{z_{max}}$					
EGC...-GK/-GP	[Nm]	51	97	380	1157
$M_{y_{max}}/M_{z_{max}}$					
EGC...-GV/-GQ	[Nm]	132	228	680	1820

Basic load ratings

Size		70	80	120	185		
Spindle pitch	[mm/rev]	10	10	20	25	40	
Ball screw drive							
Dynamic $c_{dyn,BSD}$	[N]	4000	6800	5700	14100	12700	25000

Note

For a guide system to have a service life of 5000 km, the load comparison factor must have a value of $f_v \leq 1$, based on the maximum permissible forces and torques for a service life of 5000 km.

If the axis is subjected to two or more of the indicated forces and torques simultaneously, the following equation must be satisfied in addition to the indicated maximum loads:

Calculating the load comparison factor:

$$f_v = \frac{|F_{y1}|}{F_{y1}} + \frac{|F_{z1}|}{F_{z1}} + \frac{|M_{x1}|}{M_{x1}} + \frac{|M_{y1}|}{M_{y1}} + \frac{|M_{z1}|}{M_{z1}} \leq 1$$

F_1/M_1 = dynamic value

F_2/M_2 = maximum value

Data sheet

Service life of the guide

The service life of the guide depends on the load. To be able to make a statement as to the service life of the guide, the graph below plots the load comparison factor f_v against the service life.

These values are only theoretical. You must consult your local Festo contact for a load comparison factor f_v greater than 1.5.

Load comparison factor f_v as a function of service life

Example:

A user wants to move an X kg load. Using the formula (→ page 16) gives a value of 1.5 for the load comparison factor f_v . According to the graph, the guide would have a service life of approx. 1500 km. Reducing the acceleration reduces the M_z and M_y values. A load comparison factor f_v of 1 now gives a service life of 5000 km.

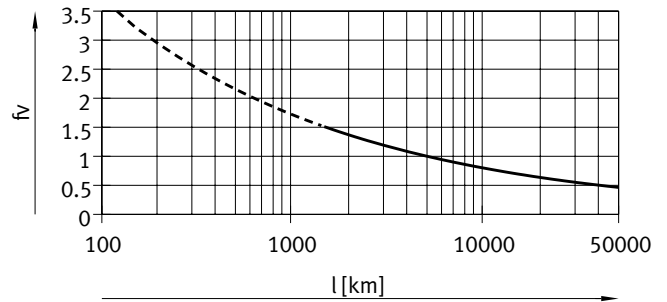

Note

Engineering software
Electric Motion Sizing
www.festo.com/x/electric-motion-sizing

The engineering software can be used to calculate the guide workload for a service life of 5000 km.

$f_v > 1.5$ are only theoretical comparison values for the recirculating ball bearing guide.

Comparison of the characteristic load values for 5000 km with dynamic forces and torques of recirculating ball bearing guides

The characteristic load values of bearing guides are standardised to ISO and JIS using dynamic and static forces and torques. These forces and torques are based on an expected service life of the guide system of 100 km to ISO or 50 km to JIS. As the characteristic load values are dependent on the service life, the maximum permissible forces and torques for a 5000 km service life cannot be compared with the dynamic forces and torques of bearing guides to ISO/JIS.

To make it easier to compare the guide capacity of linear axes EGC with bearing guides, the table below lists the theoretically permissible forces and torques for a calculated service life of 100 km. This corresponds to the dynamic forces and torques to ISO.

These 100 km values have been calculated mathematically and are only to be used for comparing with dynamic forces and torques to ISO. The drives must not be loaded with these characteristic values as this could damage the axes.

Max. permissible forces and torques for a theoretical service life of 100 km (from a guide perspective only)

Size		70	80	120	185
$F_{y_{max}}$	[N]	6815	11236	25383	55997
$F_{z_{max}}$	[N]	6815	11236	25383	55997
$M_{x_{max}}$	[Nm]	59	133	531	1949
$M_{y_{max}}/M_{z_{max}}$					
EGC...-GK/-GP	[Nm]	188	357	1400	4262
$M_{y_{max}}/M_{z_{max}}$					
EGC...-GV/-GQ	[Nm]	486	840	2505	6705

Data sheet

Service life of the spindle

- The service life of the spindle axis depends on the service life of the guide (→ page 17) and of the ball screw.
The operating coefficient plays a considerable role in determining the possible service life. It can be determined with the help of the table (→ page 19)
- The service life ends when the maximum number of switching cycles or maximum running performance has been reached:
 - 5 million switching cycles or 5000 km running performance
- The distance between the foremost and rearmost positions must be at least 2.5 times the spindle pitch per travel cycle
- The specifications for running performance are based on experimentally determined and theoretically calculated data (at room temperature).
The running performance that can be achieved in practice can deviate considerably from the specified curves under different parameters

with ball screw

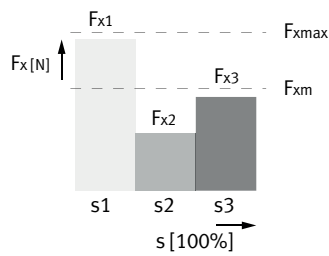
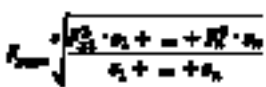

$\hat{F}_{x1/n}$ = Feed force of section
 $s_{1/n}$ = Part of movement cycle that is travel

Mean feed force F_{xm} as a function of running performance L, with an operating coefficient f_B of 1.0, at room temperature

Size 70

Size 80

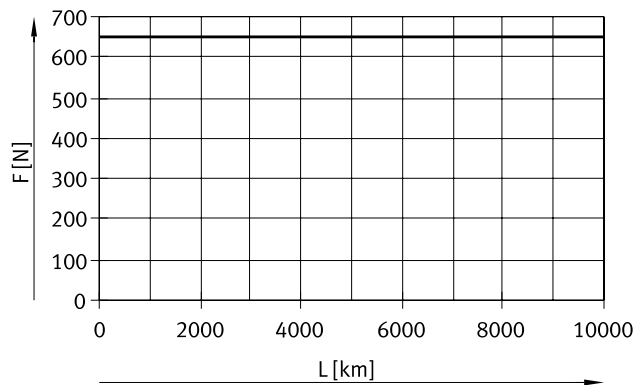
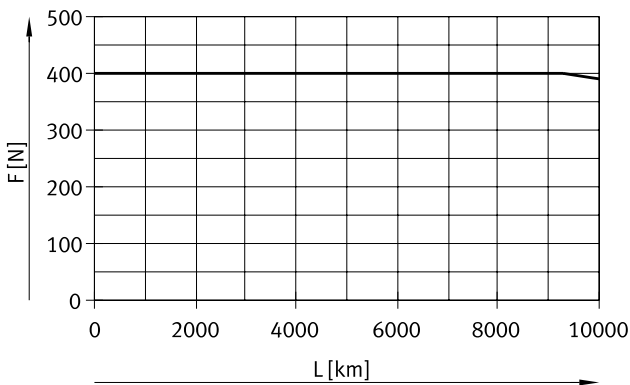

Data sheet

Mean feed force F_{xm} as a function of running performance L, with an operating coefficient f_B of 1.0, at room temperature

Size 120

Size 185

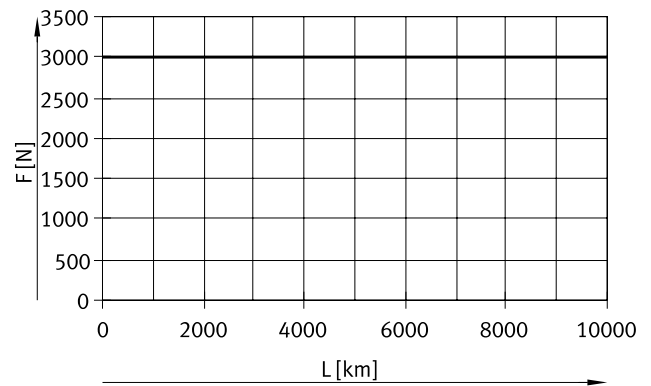
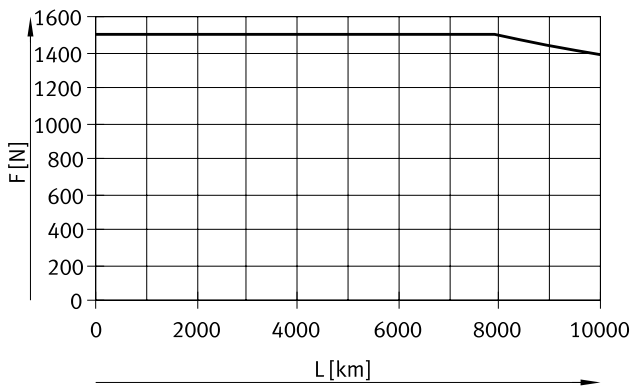

Service life taking into account the operating coefficient

$$L_{act} = \frac{L}{f_B}$$

L_{act} = Actual service life
 L = Target service life
 (→ graphs)
 f_B = Operating coefficient

Load ¹⁾	Operating coefficient f_B	Application example
None	1.0 ... 1.2	Measuring machine
Light	1.2 ... 1.4	Handling, robotics
Medium	1.4 ... 1.6	Press-in operations
High	1.6 ... 2.0	Construction, agriculture

1) Loads caused by impact, temperature, contamination, shock and vibrations

Data sheet

Speed v as a function of working stroke l

Size 70

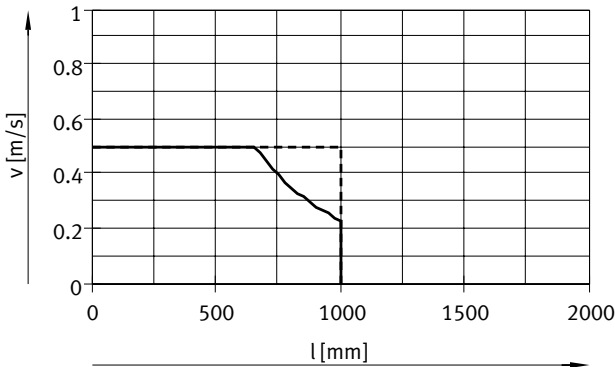

- EGC-70-10P without spindle support
- - - EGC-70-10P with spindle support

Size 80

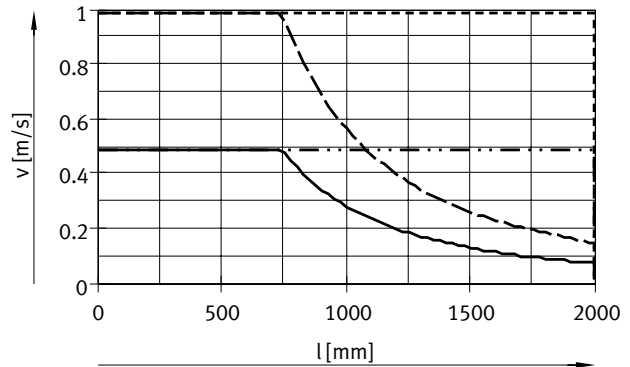

- EGC-80-10P without spindle support
- · · EGC-80-10P with spindle support
- - - EGC-80-20P without spindle support
- · - EGC-80-20P with spindle support

Size 120

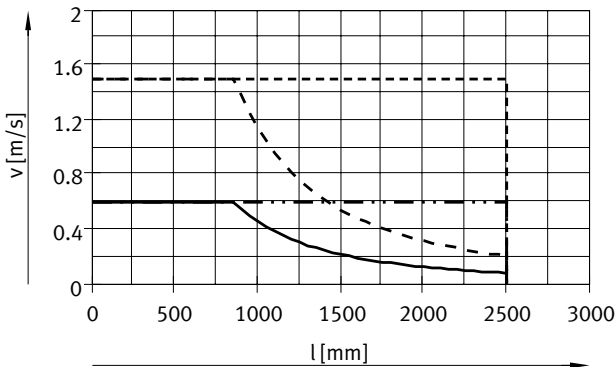

- EGC-120-10P without spindle support
- · · EGC-120-10P with spindle support
- - - EGC-120-25P without spindle support
- · - EGC-120-25P with spindle support

Size 185

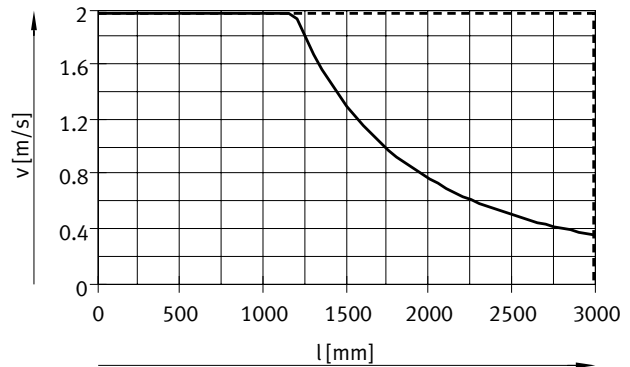

- EGC-185-40P without spindle support
- - - EGC-185-40P with spindle support

Velocity v as a function of rotational speed n

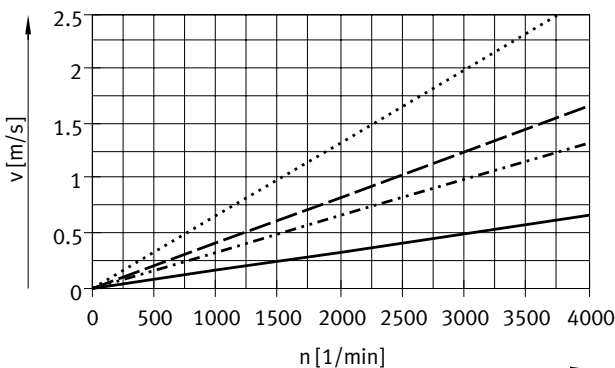

 **Note**
 Rotational speed is stroke-dependent.
 Note maximum rotational speed.

- EGC-70/-80-10P/-120-10P
- · · EGC-80-20P
- - - EGC-120-25P
- · - EGC-185-40P

Data sheet

Max. acceleration a as a function of payload m

Size 70

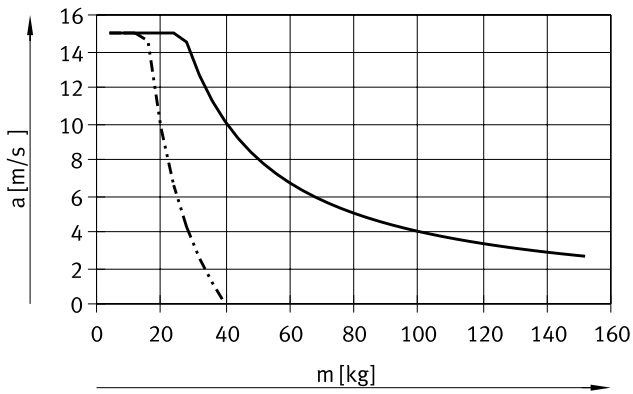

Size 80

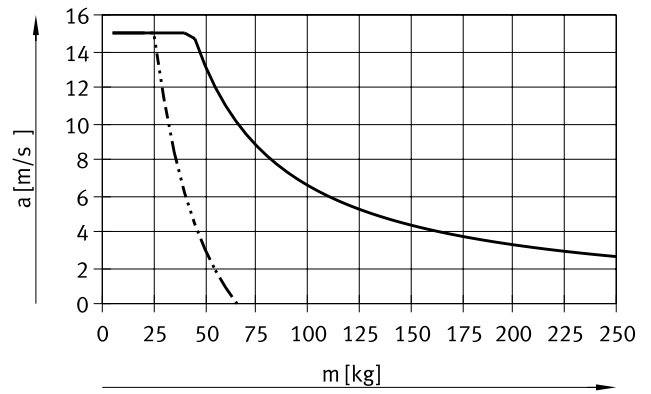

Size 120

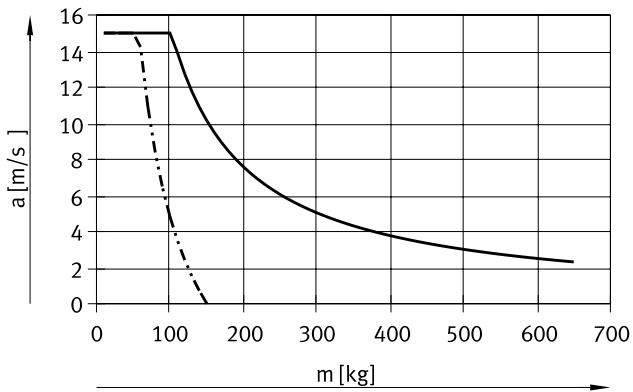

Size 185

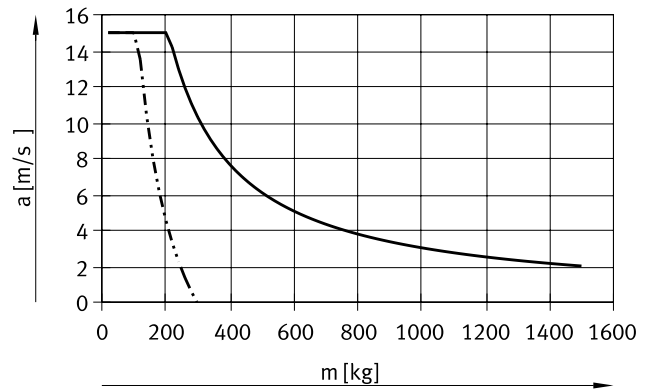

- Horizontal mounting position
- - - Vertical mounting position

Theoretical feed force F as a function of input torque M

Size 70/80

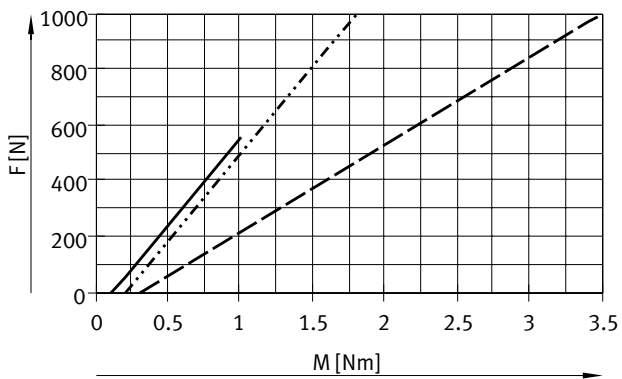

Size 120/185

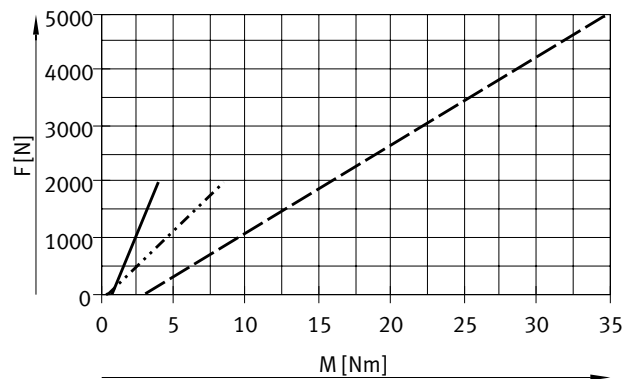

- EGC-70-10P
- · - EGC-80-10P
- - - EGC-80-20P

- EGC-120-10P
- · - EGC-120-25P
- - - EGC-185-40P

Data sheet

Stroke reserve

Stroke length	Stroke reserve	
---------------	----------------	--

The selected stroke corresponds in principle to the required working stroke. The variants GK/GV do not have a wiper seal on the guide. These variants therefore have an additional safety distance between the drive cover and slide that is not designated as part of the working stroke.

A safety distance (similar to GK/GV) between the drive cap and slide can be defined for the variants GP/GQ and GK-C/GV-C using the modular product system via the "stroke reserve" feature. With the variants GK/GV, the stroke reserve and safety distance are added for each end position.

- The stroke reserve length can be freely selected
- The sum of the stroke length and 2x stroke reserve must not exceed the maximum working stroke

Example:

EGC-70-500-BS-10P-KF-20H-...
 Working stroke = 500 mm
 2x stroke reserve = 40 mm
 Total stroke = 540 mm
 (540 mm = 500 mm + 2x 20 mm)

Size	70	80		120		185
Spindle pitch [mm/rev]	10	10	20	10	25	40
L9 = safety distance with GK/GV (per end position) [mm]	10.5	13	13	18	18	21

Working stroke reduction

With standard slide GK/GP / extended slide GV/GQ with additional slide KL/KR

- The working stroke is reduced by the length of the additional slide and the distance between both slides
- If the variant GP/GQ is ordered, the additional slide is also protected
- If the variant GV/GQ is ordered, the additional slide is not extended
- If the variant GK-C/GV-C is ordered, the additional slide is also supplied with lubrication adapters

L17 = Slide length
 L17 = Additional slide length
 L = Distance between the two slides
 [1] Additional slide

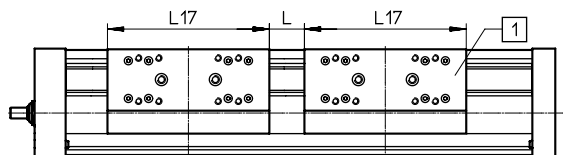

Example:

Type EGC-70-500-BS-...-GK-KL/KR
 Working stroke without additional slide = 500 mm
 L = 20 mm
 L17 = 100 mm
 Working stroke with additional slide = 380 mm
 (500 mm - 20 mm - 100 mm)

Dimensions – Additional slide

Size	70		80		120		185	
Variant	GK/GV	GP/GQ or GK-C/GV-C	GK/GV	GP/GQ or GK-C/GV-C	GK/GV	GP/GQ or GK-C/GV-C	GK/GV	GK-C/GV-C
Length L17 [mm]	100	125	120	146	200	236	280	322

Data sheet

Working stroke reduction per side

With integrated emergency buffer NPE and shock absorber retainer KYE

- The working stroke is reduced by the total dimension of the emergency buffer and shock absorber retainer.
- The rubber buffer in the cap must be removed
- Shock absorbers must not be used in combination with lubrication adapters

Size		70	80	120	185
With emergency buffer	[mm]	43	68	98	133

Working stroke reduction

With integrated clamping unit

- The working stroke is reduced by the length of the clamping unit.
- With 1-channel clamping units, the stroke is reduced on one side with respect to the mounting surface
- With 2-channel clamping units, the stroke is reduced symmetrically with respect to the mounting surface of the load
- Shock absorbers must not be used in combination with the clamping unit.

Size		80	120	185
EGC-...-1H...-PN	[mm]	87	124	131
EGC-...-2H-PN	[mm]	174	248	262

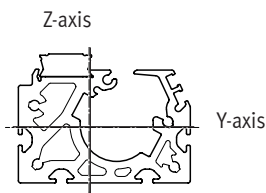
2nd moments of area

Size		70	80	120	185
I _y	[mm ⁴]	4.19x10 ⁵	9.81x10 ⁵	5.01x10 ⁶	2.61x10 ⁷
I _z	[mm ⁴]	5.78x10 ⁵	1.32x10 ⁶	5.82x10 ⁶	2.6x10 ⁷

Data sheet

Maximum permissible support spacing L (without profile mounting MUE/central support EAHF) as a function of force F

In order to limit deflection in the case of large strokes, the axis may need to be supported.

The following graphs can be used to determine the maximum permissible support span l as a function of force F acting on the axis. The deflection is $f = 0.5 \text{ mm}$.

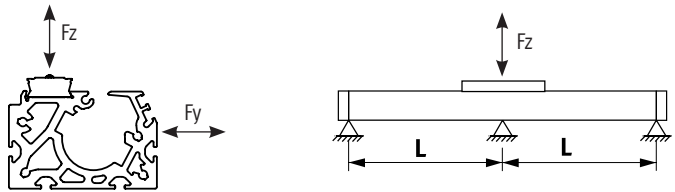

Force F_y

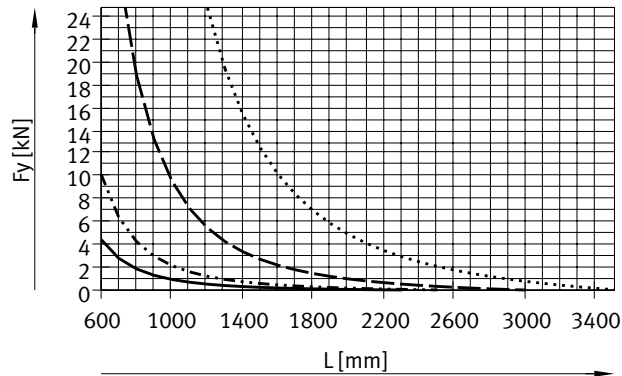

- EGC-70
- EGC-80
- - - EGC-120
- · - · EGC-185

Force F_z

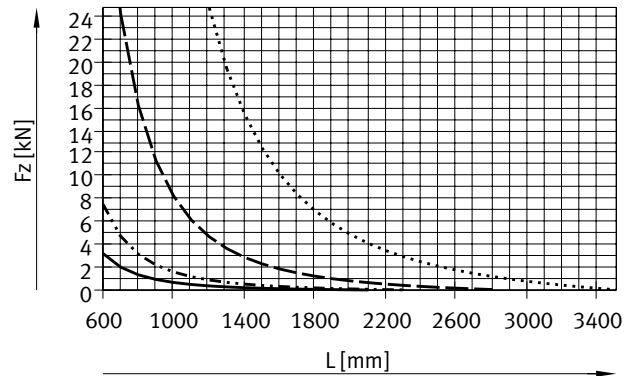

Recommended deflection limits

Adherence to the following deflection limits is recommended so as not to impair the functionality of the axes. Greater deformation can result in increased friction, greater wear and reduced service life.

Size	Dynamic deflection (moving load)	Static deflection (stationary load)
70 ... 185	0.05% of the axis length, max. 0.5 mm	0.1% of the axis length

Data sheet

Central lubrication

The lubrication adapters enable the guide and the spindle of the spindle axis EGC-BS to be permanently lubricated in applications in humid or wet ambient conditions using semi or fully automatic relubrication devices.

- For size 70, 80, 120, 185
- The modules are suitable for oils and greases.
- The dimensions of the spindle axis EGC-BS are the same with and without central lubrication modules.
- All lubrication connections must be connected
- There are three connection options on each side
- Can be used in combination with:
 - Standard slide GK
 - Additional slide KL, KR
- Cannot be used in combination with:
 - Protected recirculating ball bearing guide GP

Slide dimensions

→ page 37

Order code C in the modular product system → page 50

Connection option for customer design

The drawing on the right shows the connection option on the top lubrication interface using a customer design.

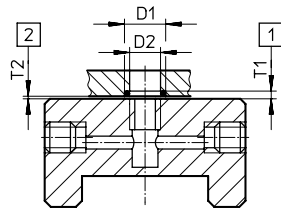

D1 $8^{+0.2}$ mm

D2 6 mm

T1 $0.6_{-0.05}$ mm

T2 $0.1^{+0.2}$ mm

O-ring $\varnothing 6 \times 1$ mm (DIN 3771)

[1] Slot depth for O-ring

[2] Required air gap

Additional dimensions → page 37

Design of a central lubrication system

A central lubrication system requires various additional components. The illustration shows different options (using a hand pump, pneumatic container pump or electric container pump) required as a minimum for designing a central lubrication system. Festo does not sell these additional components; however, they can be obtained from the following companies:

- Lincoln
- Bielomatik
- SKF (Vogel)

Festo recommends these companies because they can supply all the necessary components.

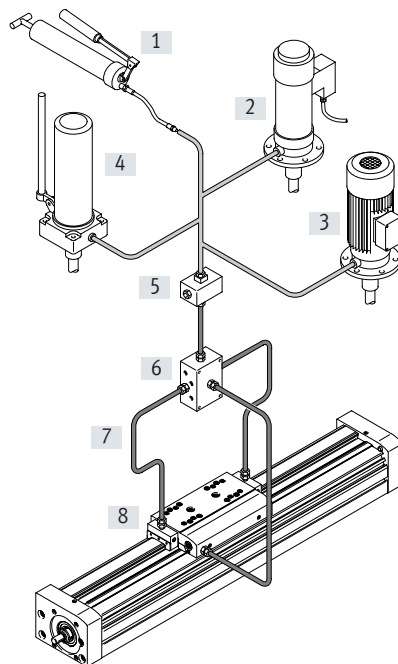

[1] Hand pump

[2] Pneumatic container pump

[3] Electric container pump

[4] Manually operated container pump

[5] Nipple block

[6] Distributor block

[7] Tubing or piping

[8] Fittings

Data sheet

Dimensions

Download CAD data → www.festo.com

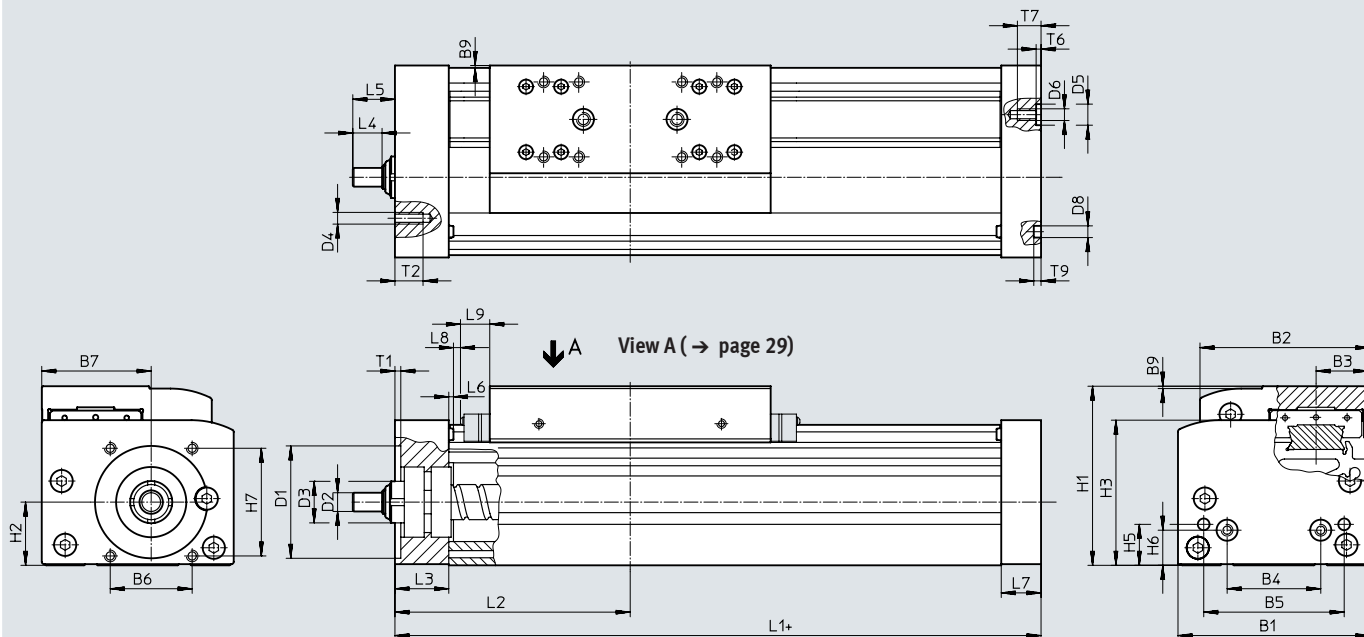

- + = plus stroke length + 2x stroke reserve
- L9 For GK/GV: safety distance per end position
- For GP/GQ: dimension for wiper seal → page 22
- For GK-C/GV-C: dimension for adapter → page 37

Working stroke reduction in combination with additional slide → page 22

Size	Variant	Stroke	B1	B2	B3	B4	B5	B6	B7	B9	D1 ∅ H7	D2 ∅ h7	D3
70	GK/GP	50 ... 1000	69	58.6	16.5	30	45	29	39	1	38	6	≅13
	GV/GQ	50 ... 900											
80	GK/GP	. 1477	82	72.6	22	40	60	35	46.75	1	48	8	∅18
		≥ 1477											
	GV/GQ	. 1377											
		≥ 1377											
120	GK/GP	. 1704	120	107	33	40	80	64	78	1	62	12	∅28
		≥ 1704											
	GV/GQ	. 1604											
		≥ 1604											
185	GK/GP	. 2361	186	169	53	120	80	80	114	1	95	25	∅44
		≥ 2361											
	GV/GQ	. 2261											
		≥ 2261											

Data sheet

Size	Variant	Stroke	D4	D5 ∅ H7	D6	D8 ∅ H7	H1	H2	H3	H5	H6	H7	L1	L2
70	GK/GP	50 ... 1000	M5	-	M5	5	64	22.5	50.5	13	13	36	168	86.5
	GV/GQ	50 ... 900											268	136.5
80	GK/GP	. 1477	M5	9	M5	5	76.5	27	62	17.5	15	46	196	101
		≥ 1477											236	121
	GV/GQ	. 1377											296	151
		≥ 1377											336	171
120	GK/GP	. 1704	M6	-	M8	9	111.5	42.5	89.5	22	22	54	309	156
		≥ 1704											369	186
	GV/GQ	. 1604											409	206
		≥ 1604											469	236
185	GK/GP	. 2361	M8	-	M10	9	172.5	65.2	141.5	25	25	80	412	209
		≥ 2361											512	259
	GV/GQ	. 2261											512	259
		≥ 2261											612	309

Size	Variant	Stroke	L3	L4	L5	L6	L7	L8	L9	T1	T2	T6	T7	T9
70	GK/GP	50 ... 1000	21	8	14	1.8	16	3	10.5	2.5	12	-	10	3.1
	GV/GQ	50 ... 900												
80	GK/GP	. 1477	23	12.5	18	2	17	3	13	2.5	12	2.1	10	3.1
		≥ 1477												
	GV/GQ	. 1377												
		≥ 1377												
120	GK/GP	. 1704	33	17.5	25.5	2	30	3	18	3	15	-	16	2.1
		≥ 1704												
	GV/GQ	. 1604												
		≥ 1604												
185	GK/GP	. 2361	43	23	30.5	2	37	3	21	3	20	-	20	2.1
		≥ 2361												
	GV/GQ	. 2261												
		≥ 2261												

 - Note

Requirements for the flatness of the bearing surface and of attachments as well as for use in parallel structures

→ www.festo.com/sp User documentation

Data sheet

Dimensions

Download CAD data → www.festo.com

Profile

Size 70

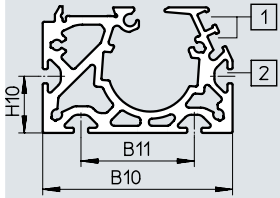

Size 80

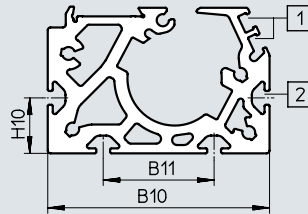

Size 120

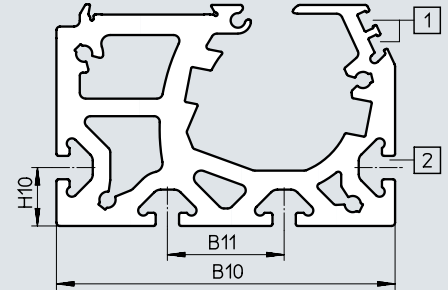

Size 185

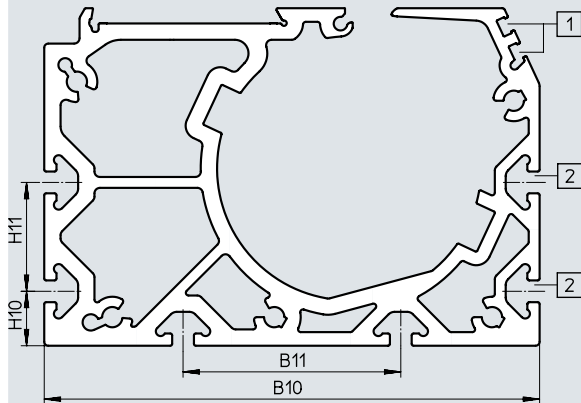

- [1] Sensor slot for proximity switch
- [2] Mounting slot for slot nut

Size	B10	B11	H10	H11
70	67	40	20	-
80	80	40	20	-
120	116	40	20	-
185	182	80	20	40

Data sheet

Dimensions

Download CAD data → www.festo.com

GK – Standard slide / GP – Standard slide, protected

Size 70

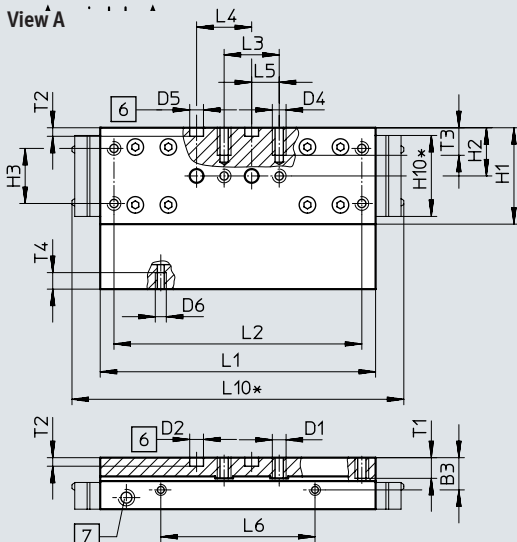
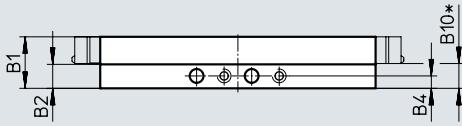

- [5] Drill hole for centring sleeve
- [6] Drilled hole for centring pin
- [7] Lubricating hole for spindle
M6 threaded connection, 8 mm deep

* Protected version

Size 80

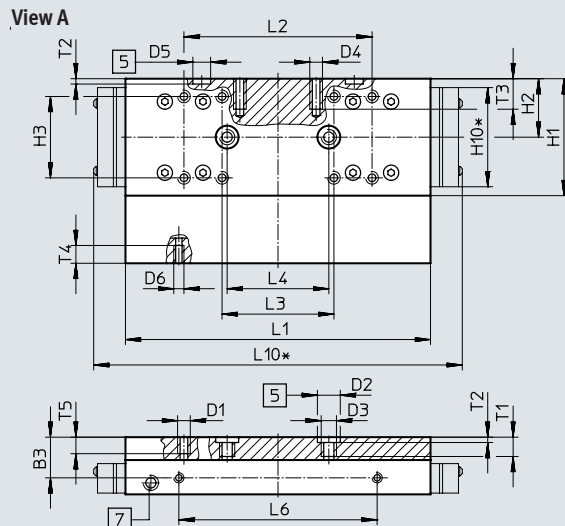
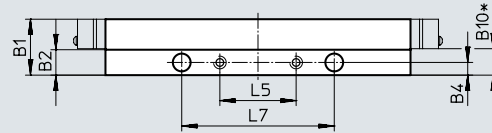

Size	B1	B2	B3	B4	B10*	D1	D2 ∅ H7	D3	D4	D5 ∅ H7	D6	H1	H2	H3
70	18.7	8.7	11.7	4.5	9	M5	5	–	M5	5	M4	35	17.5	20 ±0.1
80	22	10	16	5	10.4	M5	9	M6	M5	7	M4	46	23	32 ±0.2

Size	H10*	L1	L2	L3	L4	L5	L6	L7	L10*	T1	T2	T3	T4	T5
		±0.1			±0.03		±0.1	±0.05			+0.1			
70	29.4	100	90 ±0.1	20 ±0.1	20	10 ±0.1	56	–	121	7.5	3.1	10	6	–
80	39	120	74 ±0.2	44 ±0.2	40	30 ±0.1	78	60	145	8.6	2.1	12	7	7.5

* Protected version

Data sheet

Dimensions

Download CAD data → www.festo.com

GK – Standard slide / GP – Standard slide, protected

Size 120

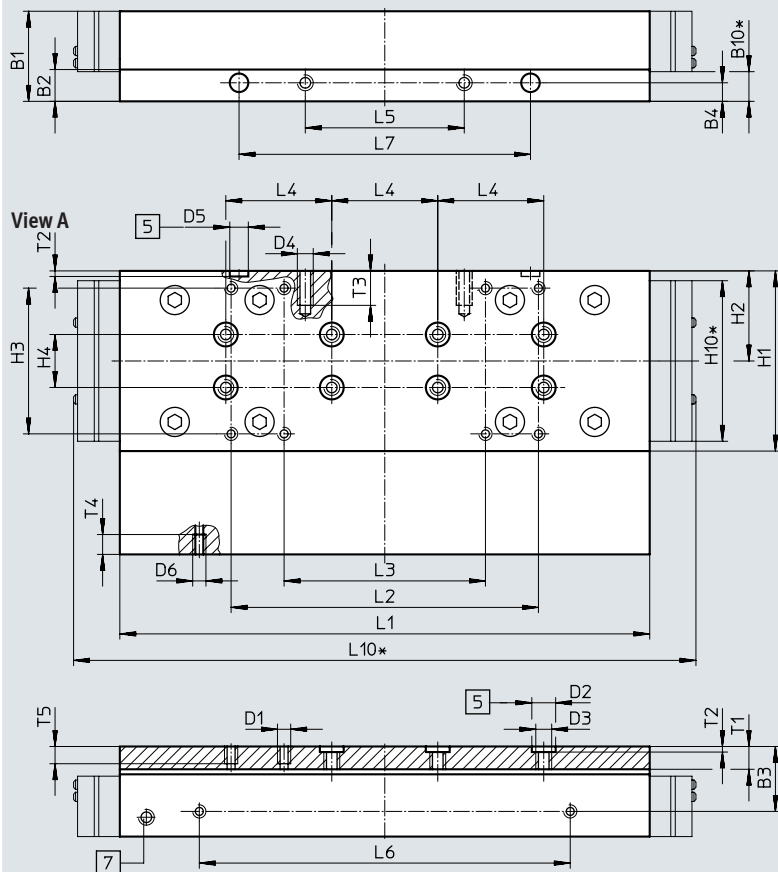

- [5] Drill hole for centring sleeve
- [7] Lubricating hole for spindle
M6 threaded connection, 8 mm deep
- * Protected version

Size	B1	B2	B3	B4	B10*	D1	D2 ∅ H7	D3	D4	D5 ∅ H7	D6	H1	H2	H3	H4
120	34	12	24.5	7	11.2	M5	9	M6	M6	7	M5	68	34	55 ±0.2	20

Size	H10*	L1	L2	L3	L4	L5	L6	L7	L10*	T1	T2	T3	T4	T5
120	60.6	±0.1	±0.2	±0.2	±0.03	±0.1	±0.1	±0.05	235	8.6	+0.1	13	7.5	7.5

* Protected version

Data sheet

Dimensions

Download CAD data → www.festo.com

GK – Standard slide

Size 185

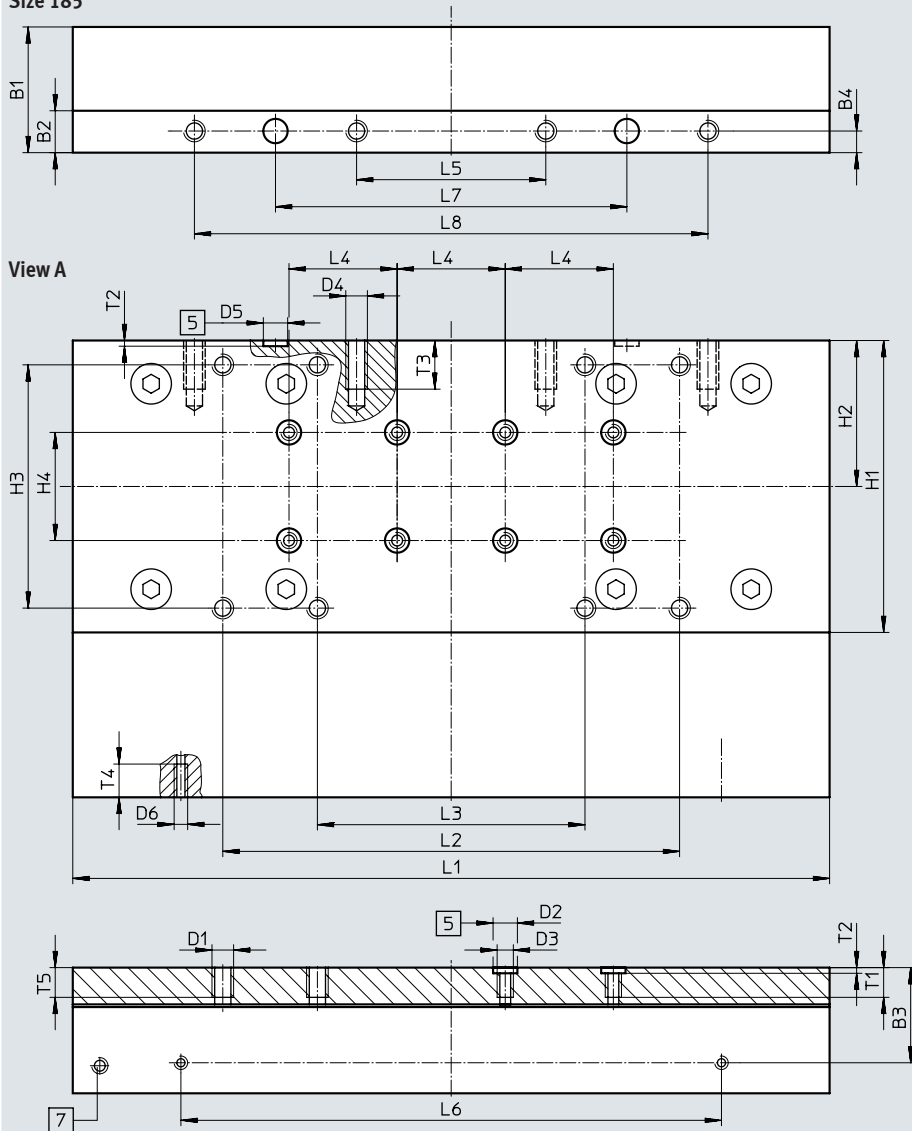

- [5] Drill hole for centring sleeve
- [7] Lubricating hole for spindle
M6 threaded connection, 8 mm deep

Size	B1	B2	B3	B4	D1	D2 ∅ H7	D3	D4	D5 ∅ H7	D6	H1	H2	H3 ±0.2	H4 ±0.03
185	46.5	15.5	35.2	8	M8	9	M6	M8	9	M5	108	54	90	40

Size	L1	L2	L3	L4	L5	L6	L7	L8	T1	T2 +0.1	T3	T4	T5
185	282.8	169	99	40	70	200	130	190	11	2.1	18	12.3	12

Data sheet

Dimensions

Download CAD data → www.festo.com

GV – Extended slide / GQ – Extended slide, protected

Size 70

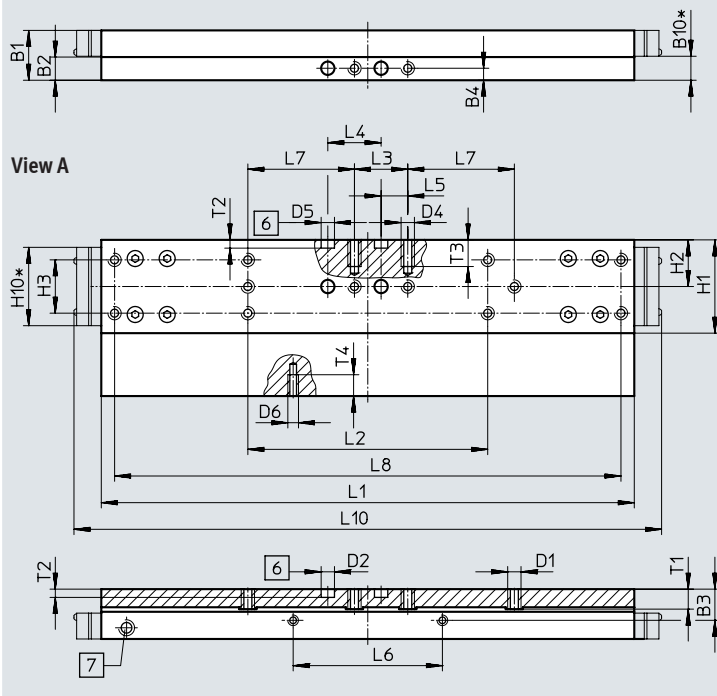

- [6] Drilled hole for centring sleeve
- [7] Lubricating hole for spindle
M6 threaded connection, 8 mm deep
- * Protected version

Size	B1	B2	B3	B4	B10*	D1	D2 ∅ H7	D4	D5 ∅ H7
70	18.7	8.7	11.7	4.5	9	M5	5	M5	5

Size	D6	H1	H2	H3	H10*	L1	L2	L3	L4
70	M4	35	17.5	±0.1 20	±0.1 29.4	±0.1 200	±0.1 90	±0.1 20	±0.03 20

Size	L5	L6	L7	L8	L10*	T1	T2	T3	T4
70	±0.1 10	±0.1 56	±0.1 40	±0.2 190	221	7.5	+0.1 3.1	10	6

* Protected version

Data sheet

Dimensions

Download CAD data → www.festo.com

GV – Extended slide / GQ – Extended slide, protected

Size 80

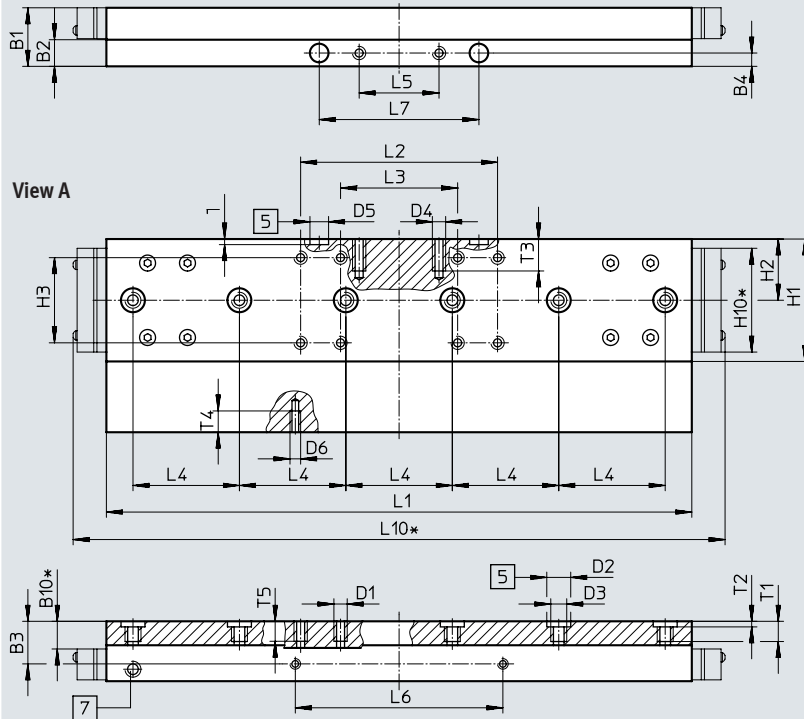

- [5] Drill hole for centring sleeve
- [7] Lubricating hole for spindle
M6 threaded connection, 8 mm deep
- * Protected version

Size	B1	B2	B3	B4	B10*	D1	D2 ∅ H7	D3	D4	D5 ∅ H7
80	22	10	16	5	10.4	M5	9	M6	M5	7

Size	D6	H1	H2	H3	H10*	L1	L2	L3	L4
				±0.2		±0.1	±0.2	±0.2	±0.03
80	M4	46	23	32	39	220	74	44	40

Size	L5	L6	L7	L10*	T1	T2	T3	T4	T5
	±0.1	±0.1	±0.05			+0.1			
80	30	78	60	245	8.6	2.1	12	7	7.5

* Protected version

Data sheet

Dimensions

Download CAD data → www.festo.com

GV – Extended slide / GQ – Extended slide, protected

Size 120

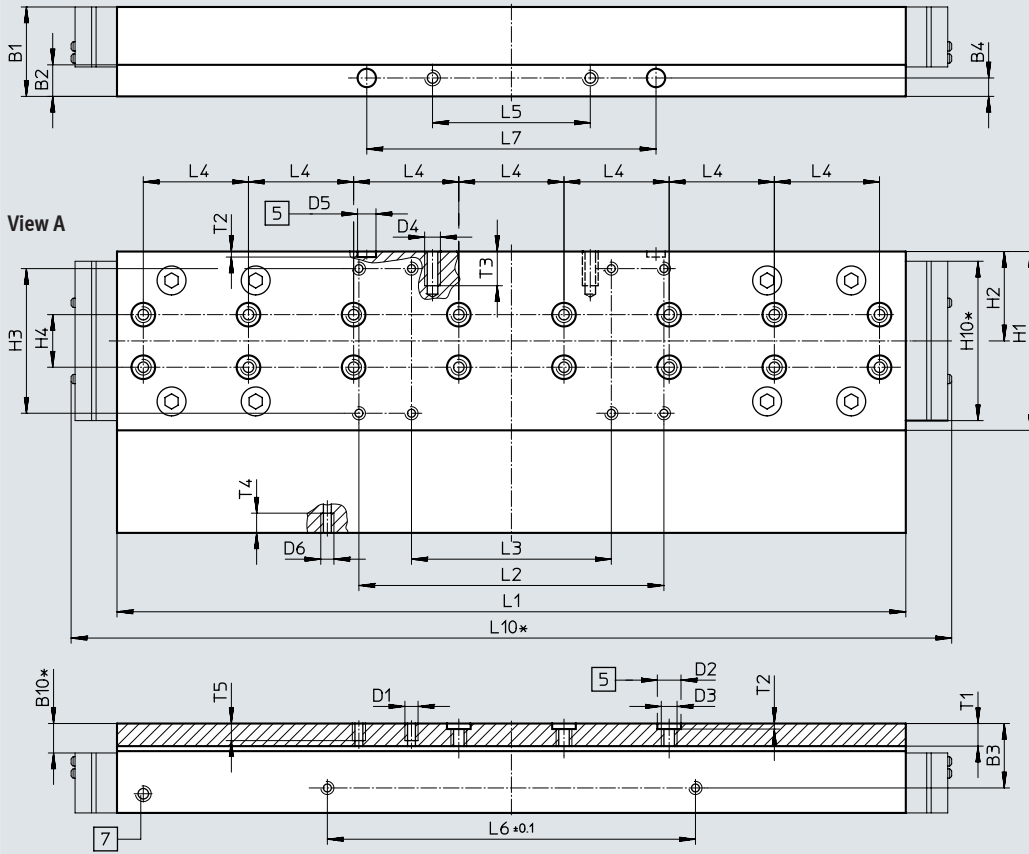

- [5] Drill hole for centring sleeve
- [7] Lubricating hole for spindle
M6 threaded connection, 8 mm deep
- * Protected version

Size	B1	B2	B3	B4	B10*	D1	D2 ∅ H7	D3	D4	D5 ∅ H7
120	34	12	24.5	7	11.2	M5	9	M6	M6	7
Size	D6	H1	H2	H3	H4	H10*	L1	L2	L3	L4
120	M5	68	34	55 ± 0.2	20	60.6	303.3	116 ± 0.2	76 ± 0.2	40
Size	L5	L6	L7	L8	L10*	T1	T2	T3	T4	T5
120	± 0.1	± 0.1	110 ± 0.05	–	335	8.6	± 0.1	13	7.5	7.5

* Protected version

Data sheet

Dimensions

Download CAD data → www.festo.com

GV – Extended slide

Size 185

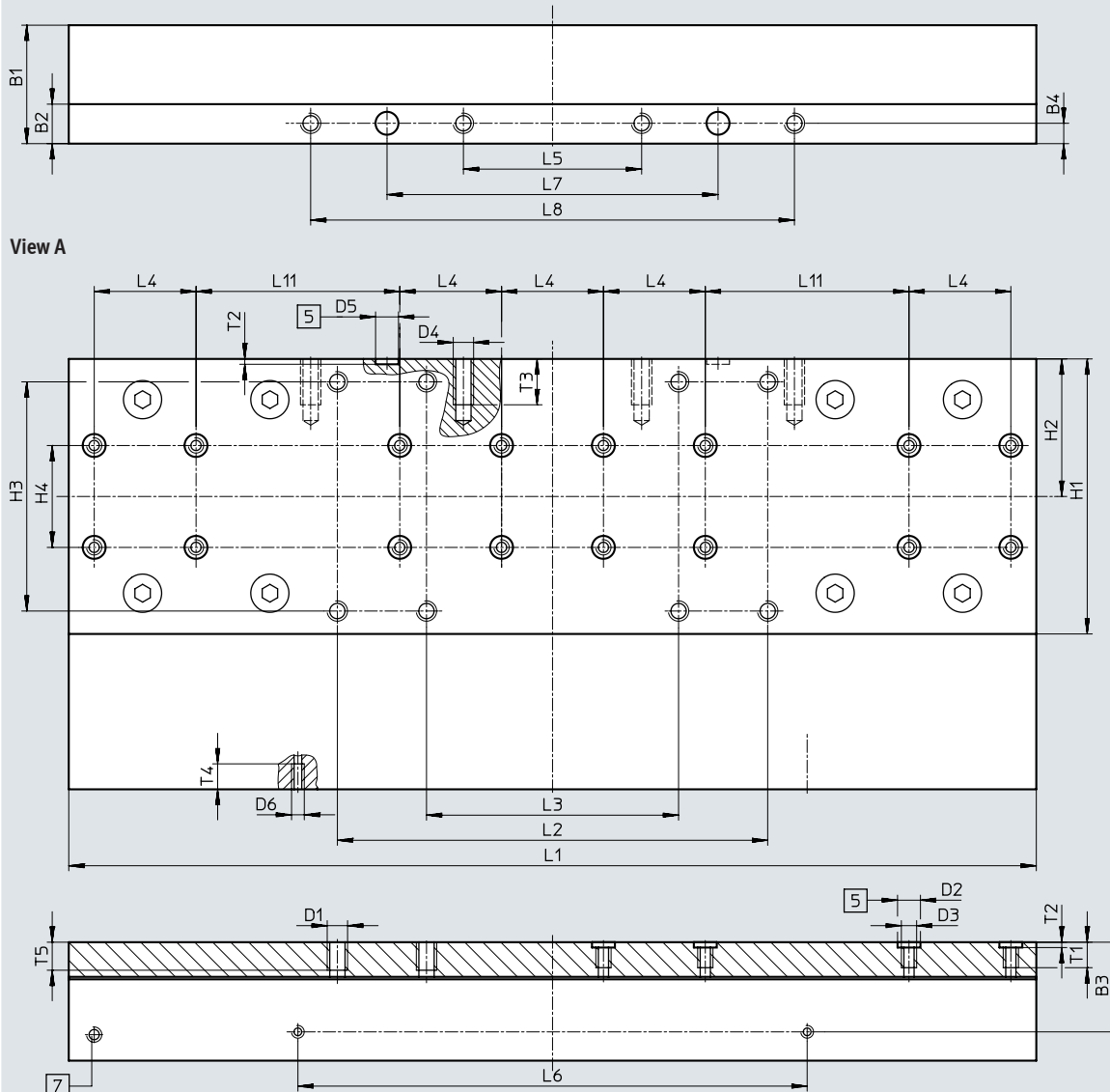

- [5] Drill hole for centring sleeve
- [7] Lubricating hole for spindle
M6 threaded connection, 8 mm deep

Size	B1	B2	B3	B4	D1	D2 ∅ H7	D3	D4	D5 ∅ H7	
185	46.5	15.5	35.2	8	M8	9	M6	M8	9	
Size	D6	H1	H2	H3	H4	L1	L2	L3	L4	
185	M5	108	54	90	40	382.8	169	99	40	
Size	L5	L6	L7	L8	L11	T1	T2	T3	T4	T5
185	±0.2	±0.1	±0.05	±0.2	±0.03		+0.1			
185	70	200	130	190	80	11	2.1	18	10	12

Data sheet

Dimensions

Download CAD data → www.festo.com

GK-C – Standard slide with lubrication adapter

Size 70

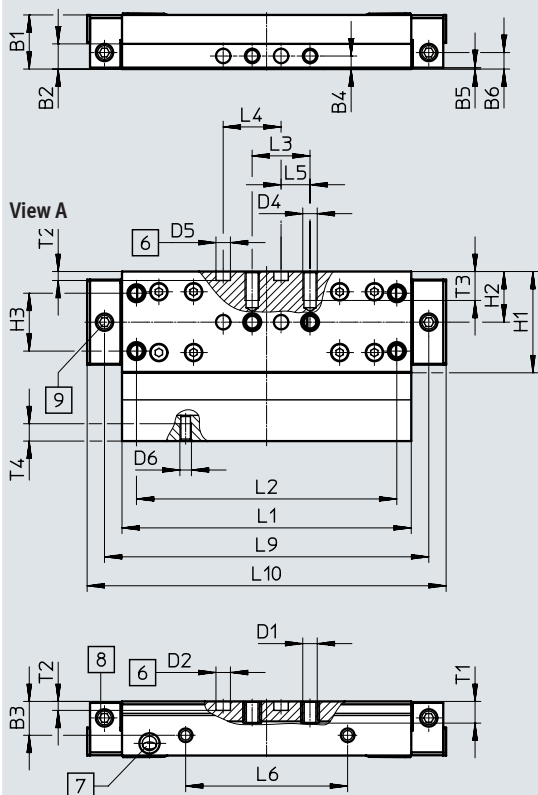

- [6] Drilled hole for centring pin
- [7] Lubricating hole for spindle
M6 threaded connection, 8 mm deep
- [8] Lubricating hole for lubrication adapter
M6 threaded connection, 6 mm deep
- [9] Lubricating hole for lubrication adapter
M6 threaded connection, 5.5 mm deep

Size	B1	B2	B3	B4	B5	B6	D1	D2 ∅ H7	D4
70	18.7	8.7	11.7	4.5	0.5	5.7	M5	5	M5

Size	D5 ∅ H7	D6	H1	H2	H3	L1	L2	L3	L4
70	5	M4	35	17.5	±0.1	±0.1	±0.1	±0.1	±0.03

Size	L5	L6	L9	L10	L11	T1	T2	T3	T4
70	10	±0.1	56	112.1	124.1	30	+0.1	10	6

Data sheet

Dimensions

Download CAD data → www.festo.com

GK-C – Standard slide with lubrication adapter

Size 80

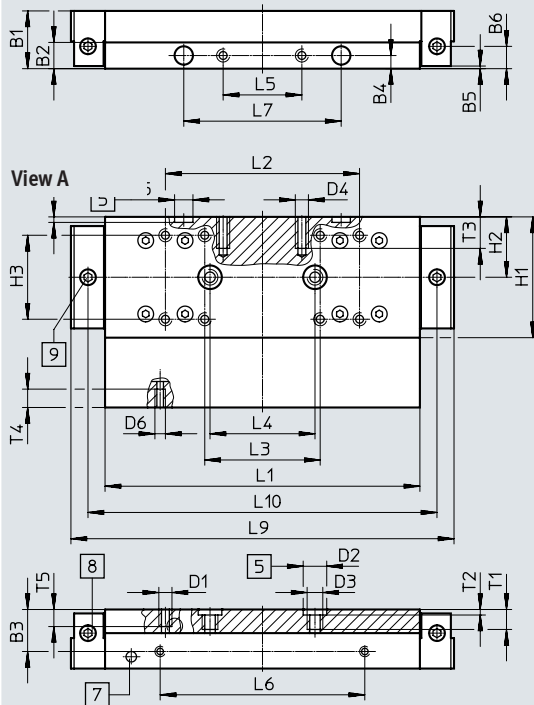

Size 120

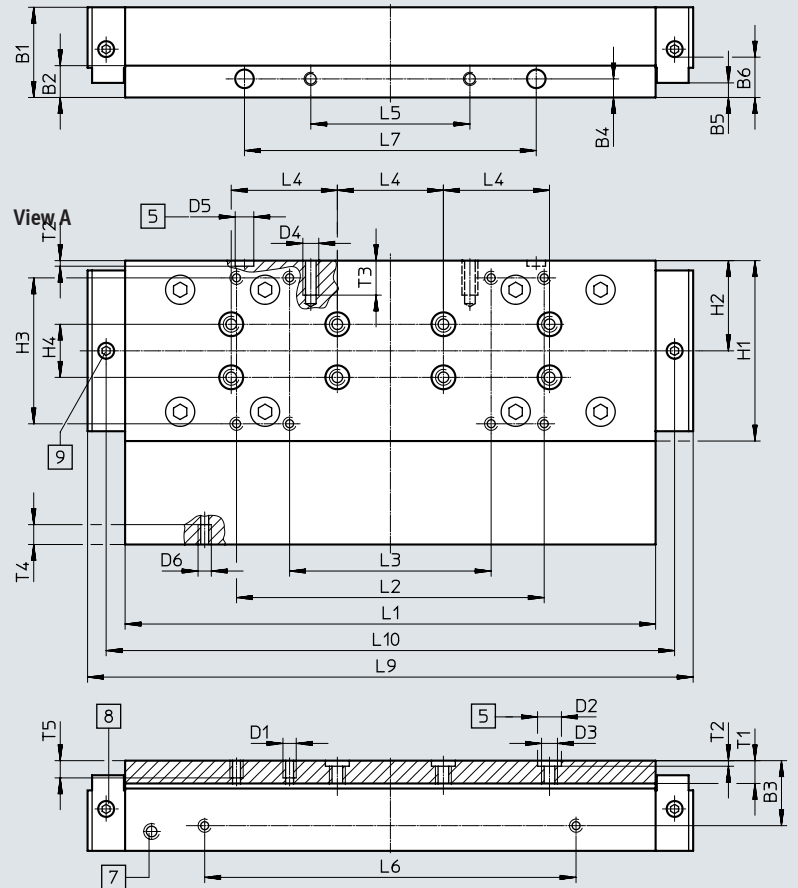

- [5] Drill hole for centring sleeve
- [7] Lubricating hole for spindle
M6 threaded connection, 8 mm deep
- [8] Lubricating hole for lubrication adapter
M6 threaded connection, 6 mm deep
- [9] Lubricating hole for lubrication adapter
M6 threaded connection, 5.5 mm deep

Size	B1	B2	B3	B4	B5	B6	D1	D2 ∅ H7	D3	D4
80	22	10	16	5	±0.1 1	8.5	M5	9	M6	M5
120	34	12	24.5	7	5.5	13.9	M5	9	M6	M6

Size	D5 ∅ H7	D6	H1	H2	H3	H4	L1	L2	L3	L4
80	7	M4	46	23	±0.2 32	±0.03 -	±0.1 120	±0.2 74	±0.2 44	±0.03 40
120	7	M5	68	34	55	20	203.3	116	76	40

Size	L5	L6	L7	L9	L10	T1	T2	T3	T4	T5
	±0.1	±0.1	±0.05				±0.1			
80	30	78	60	146	133	8.6	2.1	12	7	7.5
120	60	140	110	228.3	214.3	8.6	2.1	13	7.5	7.5

Data sheet

Dimensions

Download CAD data → www.festo.com

GK-C – Standard slide with lubrication adapter

Size 185

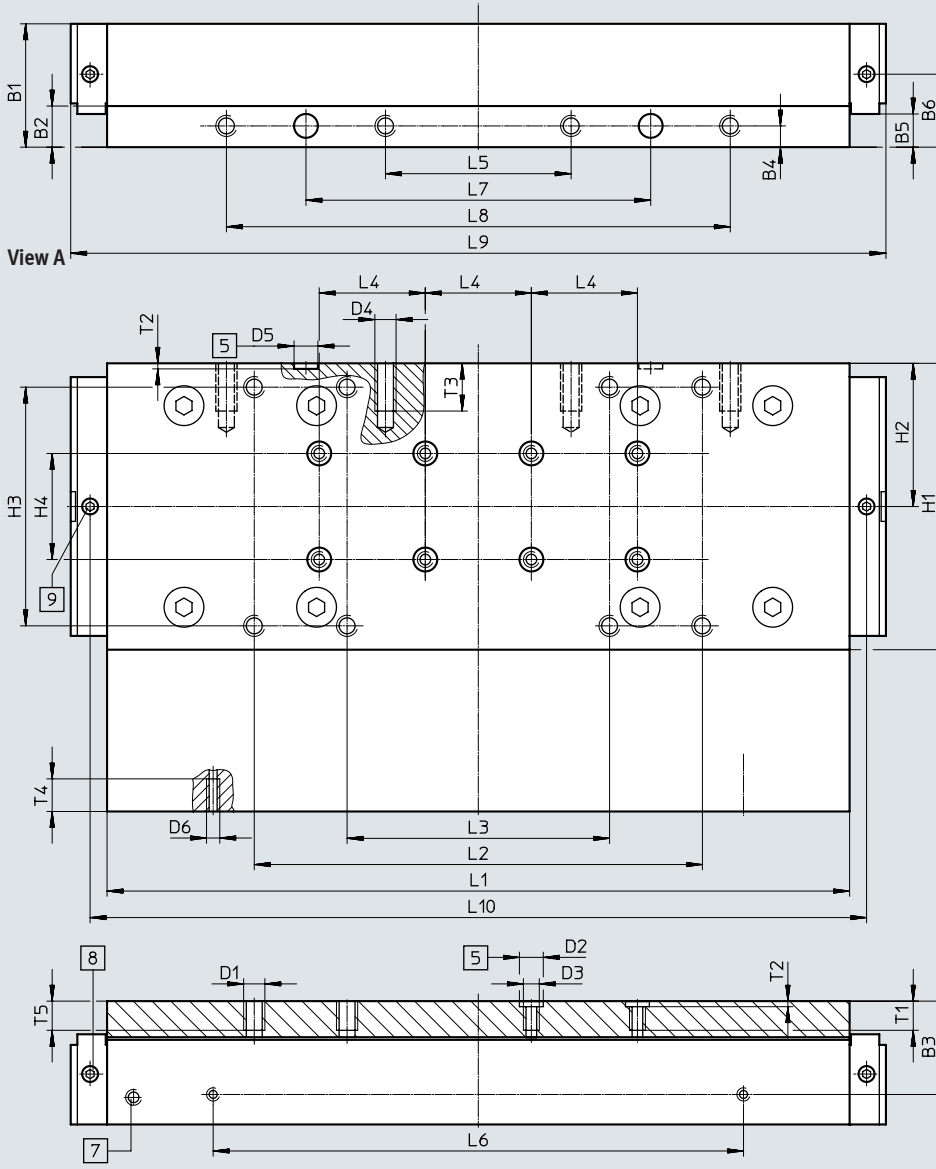

- [5] Drill hole for centring sleeve
- [7] Lubricating hole for spindle
M6 threaded connection, 8 mm deep
- [8] Lubricating hole for lubrication adapter
M6 threaded connection, 6 mm deep
- [9] Lubricating hole for lubrication adapter
M6 threaded connection, 5.5 mm deep

Size	B1	B2	B3	B4	B5	B6	D1	D2	D3	D4
185	46.5	15.5	35.2	8	±0.1 12.5	27.5	M8	∅ H7 9	M6	M8

Size	D5	D6	H1	H2	H3	H4	L1	L2	L3	L4
185	∅ H7 9	M5	108	54	±0.2 90	±0.03 40	±0.1 282.8	±0.2 169	±0.2 99	±0.03 40

Size	L5	L6	L7	L8	L9	L10	T1	T2	T3	T4	T5
185	±0.2 70	±0.1 200	±0.05 130	±0.2 190	307.4	292.8	11	+0.1 2.1	18	12.3	12

Data sheet

Dimensions

Download CAD data → www.festo.com

GV-C – Extended slide with lubrication adapter

Size 70

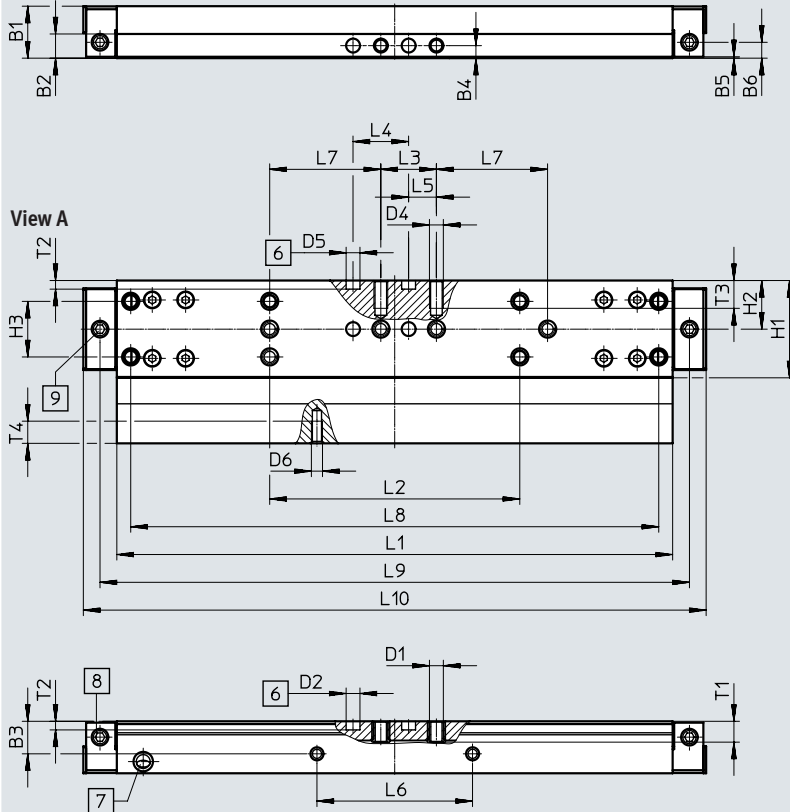

- [6] Drilled hole for centring pin
- [7] Lubricating hole for spindle
M6 threaded connection, 8 mm deep
- [8] Lubricating hole for lubrication adapter
M6 threaded connection, 6 mm deep
- [9] Lubricating hole for lubrication adapter
M6 threaded connection, 5.5 mm deep

Size	B1	B2	B3	B4	B5	B6	D1	D2 ∅ H7	D4	D5 ∅ H7
70	18.7	8.7	11.7	4.5	0.5	5.7	M5	5	M5	5

Size	D6	H1	H2	H3	L1	L2	L3	L4	L5	L6
70	M4	35	17.5	±0.1 20	±0.1 200	±0.1 90	±0.1 20	±0.03 20	10	±0.1 56

Size	L7	L8	L9	L10	L11	T1	T2	T3	T4
70	±0.1 40	±0.2 190	212.1	224.1	30	7.5	+0.1 3.1	10	6

Data sheet

Dimensions

Download CAD data → www.festo.com

GV-C – Extended slide with lubrication adapter

Size 80

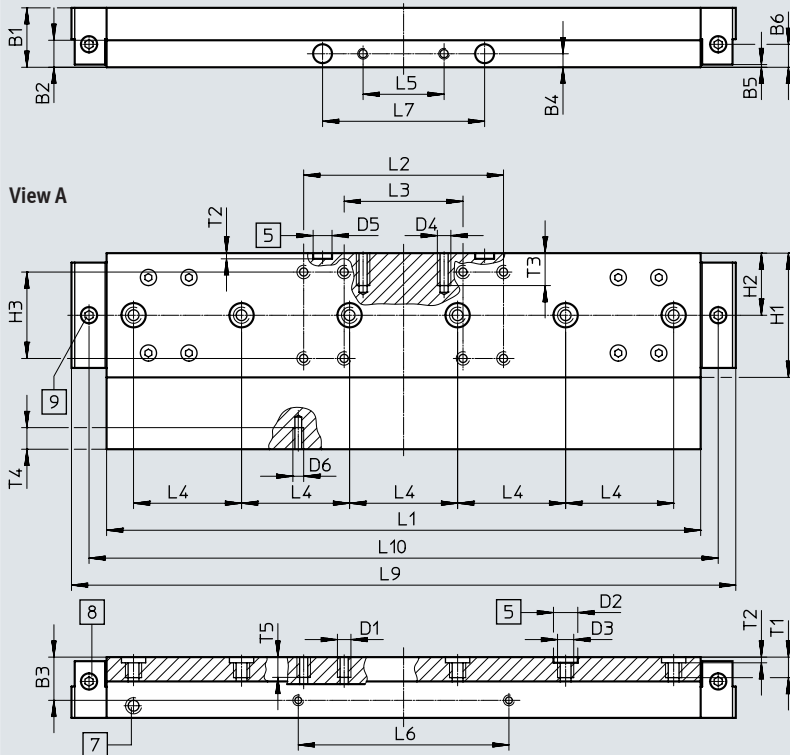

- [5] Drill hole for centring sleeve
- [7] Lubricating hole for spindle
M6 threaded connection, 8 mm deep
- [8] Lubricating hole for lubrication adapter
M6 threaded connection, 6 mm deep
- [9] Lubricating hole for lubrication adapter
M6 threaded connection, 5.5 mm deep

Size	B1	B2	B3	B4	B5	B6	D1	D2 ∅ H7	D3	D4
80	22	10	16	5	±0.1 1	8.5	M5	9	M6	M5

Size	D5 ∅ H7	D6	H1	H2	H3	L1	L2	L3	L4	L5
80	7	M4	46	23	±0.2 32	±0.1 220	±0.2 74	±0.2 44	±0.03 40	±0.1 30

Size	L6	L7	L9	L10	T1	T2	T3	T4	T5
80	±0.1 78	±0.05 60	246	233	8.6	+0.1 2.1	12	7	7.5

Data sheet

Dimensions

Download CAD data → www.festo.com

GV-C – Extended slide with lubrication adapter

Size 120

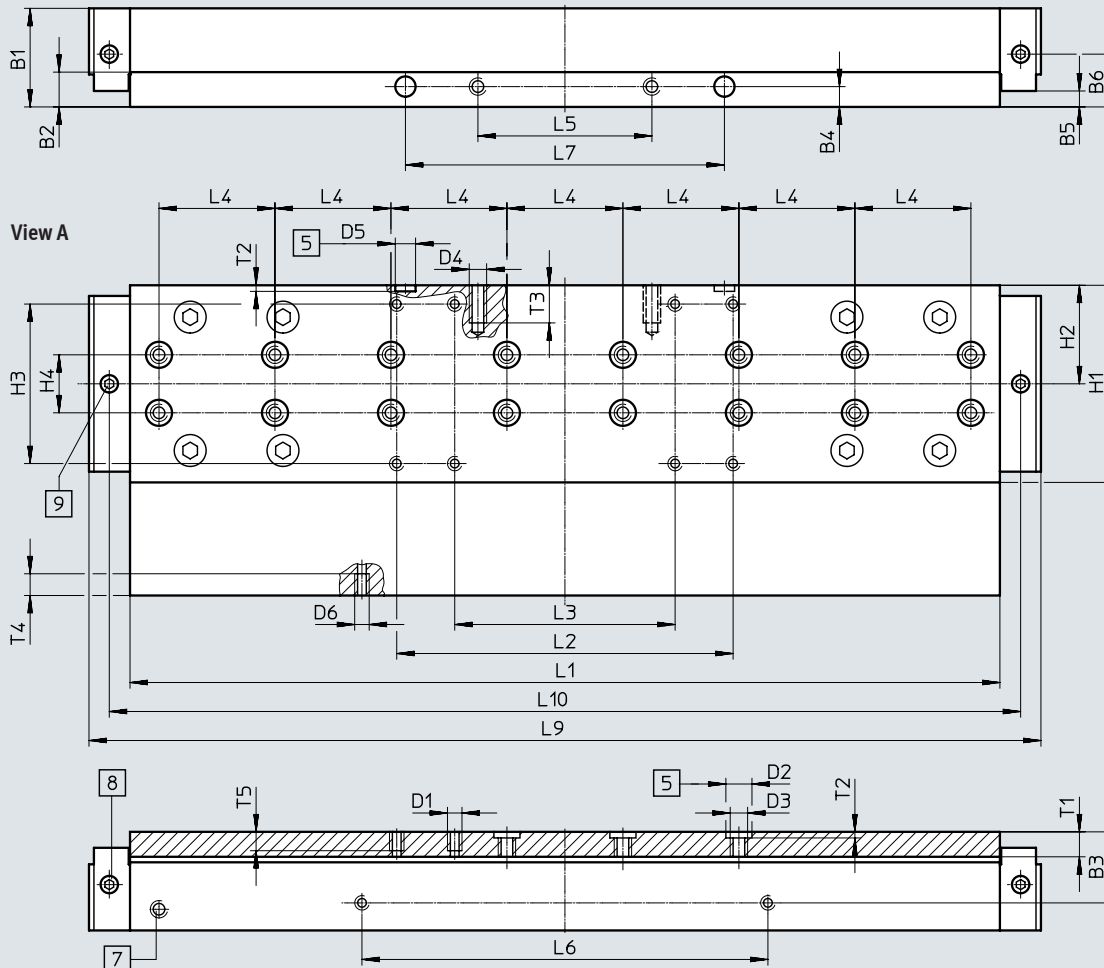

- [5] Drill hole for centring sleeve
- [7] Lubricating hole for spindle
M6 threaded connection, 8 mm deep
- [8] Lubricating hole for lubrication adapter
M6 threaded connection, 6 mm deep
- [9] Lubricating hole for lubrication adapter
M6 threaded connection, 5.5 mm deep

Size	B1	B2	B3	B4	B5	B6	D1	D2 ∅ H7	D3	D4
120	34	12	24.5	7	5.5	13.9	M5	9	M6	M6

Size	D5 ∅ H7	D6	H1	H2	H3	H4	L1	L2	L3	L4
120	7	M5	68	34	55	20	303.3	116	76	40

Size	L5	L6	L7	L9	L10	T1	T2	T3	T4	T5
120	60	140	110	328.3	314.3	8.6	2.1	13	7.5	7.5

Data sheet

Dimensions

Download CAD data → www.festo.com

GV-C – Extended slide with lubrication adapter

Size 185

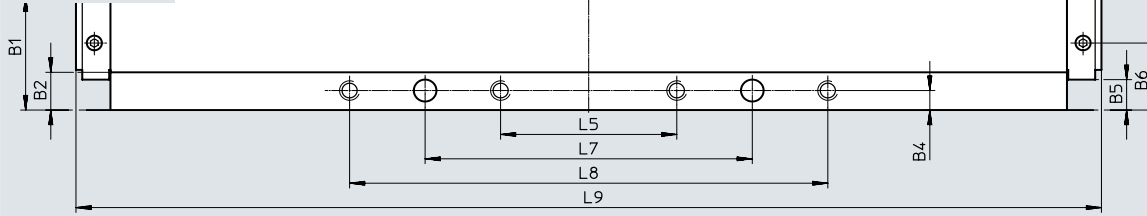

View A

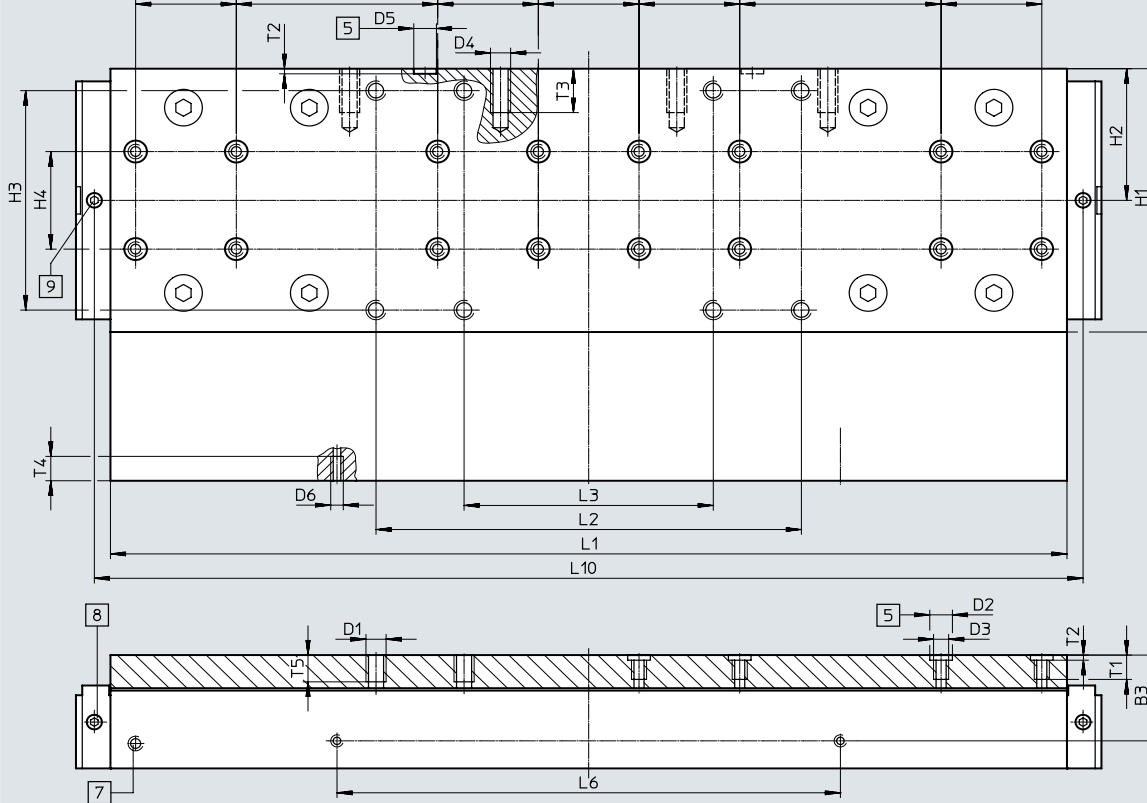

- [5] Drill hole for centring sleeve
- [7] Lubricating hole for spindle
M6 threaded connection, 8 mm deep
- [8] Lubricating hole for lubrication adapter
M6 threaded connection, 6 mm deep
- [9] Lubricating hole for lubrication adapter
M6 threaded connection, 5.5 mm deep

Size	B1	B2	B3	B4	B5	B6	D1	D2 ∅ H7	D3	D4
185	46.5	15.5	35.2	8	±0.1 12.5	27.5	M8	9	M6	M8

Size	D5 ∅ H7	D6	H1	H2	H3	H4	L1	L2	L3	L4	L5
185	9	M5	108	54	±0.2 90	±0.03 40	±0.1 382.8	±0.2 169	±0.2 99	±0.03 40	±0.2 70

Size	L6	L7	L8	L9	L10	L11	T1	T2	T3	T4	T5
185	±0.1 200	±0.05 130	±0.2 190	407.4	392.8	±0.03 80	11	+0.1 2.1	18	10	12

Data sheet

Dimensions

Download CAD data → www.festo.com

M1/M2 – With incremental displacement encoder

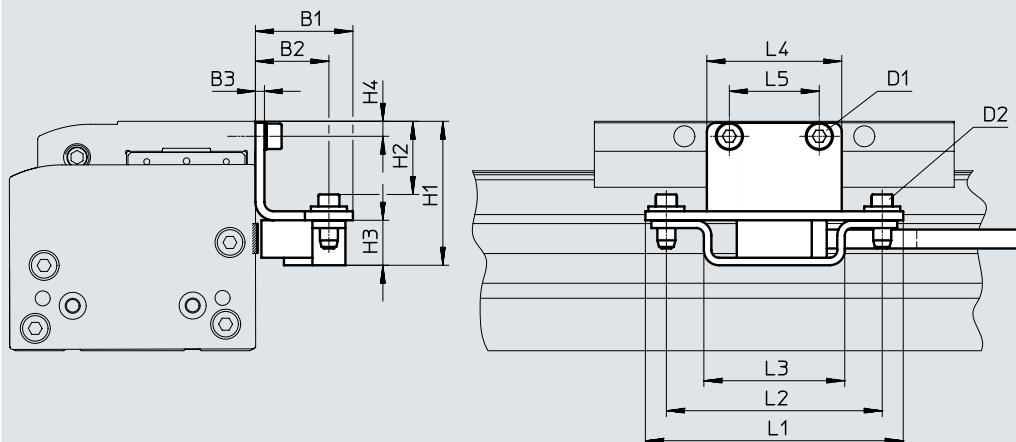

Encoder cable
(connection to the motor controller/
safety system) → page 67

Type	B1	B2	B3	H1	H2	H3	H4
EGC-70-...-M1	32.5	24.5	3	39	18.4	15	4.5
EGC-70-...-M2				39	18.4		4.5
EGC-80-...-M1				48	24.4		5
EGC-80-...-M2				48	24.4		5
EGC-120-...-M1				60	36.4		7
EGC-120-...-M2				60	36.4		7
EGC-185-...-M1				78.5	54.9		8
EGC-185-...-M2				78.5	54.9		8

Type	D1	D2	L1	L2	L3	L4	L5
EGC-70-...-M1	M5x8	M4x14	86	72	47	35	20
EGC-70-...-M2	M5x8					35	20
EGC-80-...-M1	M5x8					45	30
EGC-80-...-M2	M5x8					45	30
EGC-120-...-M1	M6x10					86	60
EGC-120-...-M2	M6x10					86	60
EGC-185-...-M1	M8x12					86	70
EGC-185-...-M2	M8x12					86	70

Data sheet

Dimensions

Download CAD data → www.festo.com

1HL/1HR/2H – With clamping unit

Size 80

1-channel, left

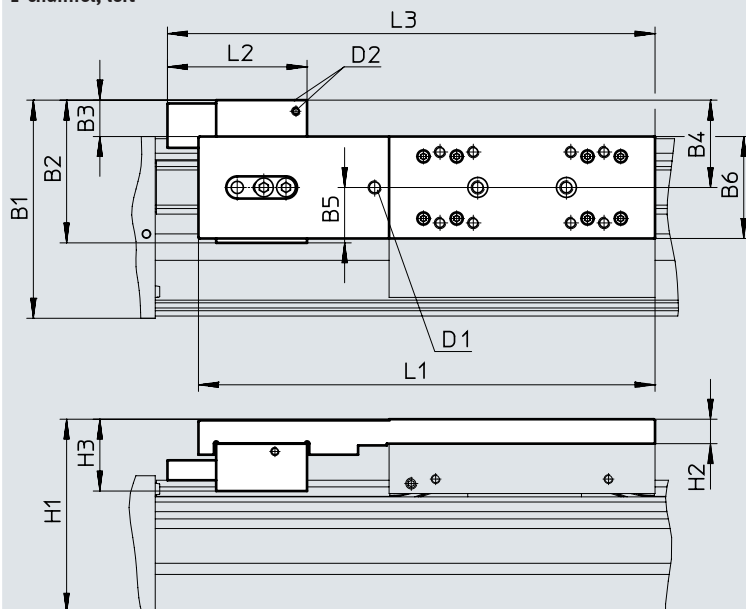

1-channel, right

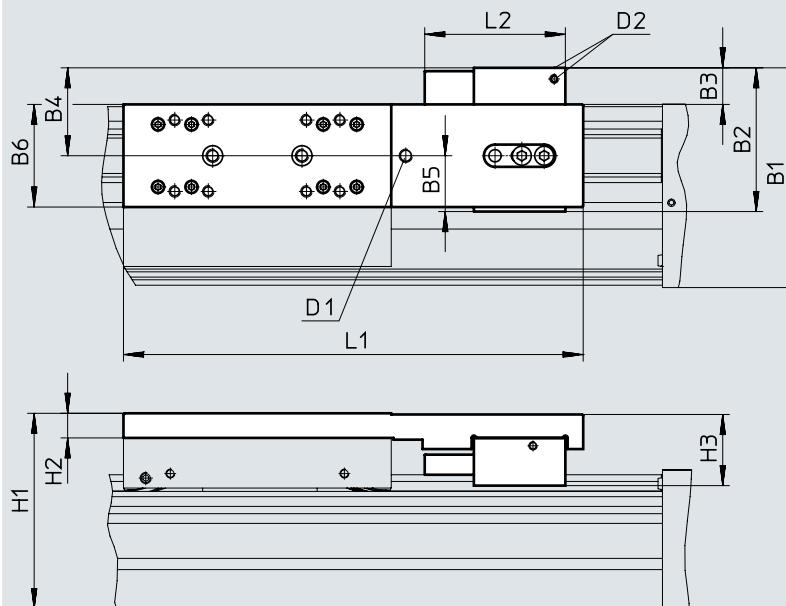

- D1 Optional: threaded connection for lubrication adapter
- D2 Compressed air supply ports

Working stroke reduction in combination with clamping unit → page 23

Data sheet

Dimensions

Download CAD data → www.festo.com

1HL/1HR/2H – With clamping unit

Size 80

2-channel

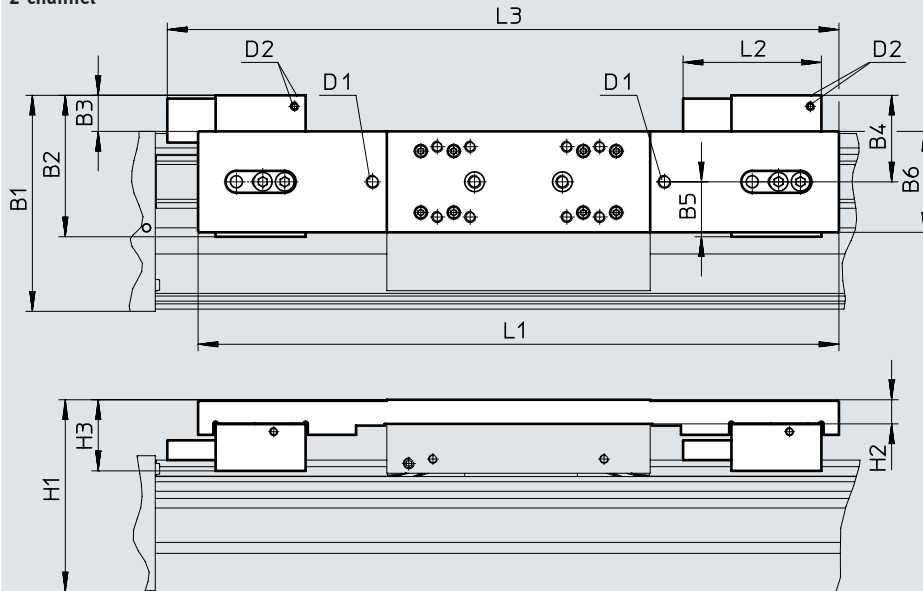

- D1 Optional: threaded connection for lubrication adapter
- D2 Compressed air supply ports

Working stroke reduction in combination with clamping unit → page 23

Type	B1	B2	B3	B4	B5	B6	H1	H2	H3	D1	D2	L1	L2	L3
EGC-80-...-1HL-PN	98.4	64.4	17.4	39.4	25	46	87.5	11	32.4	M6	M5	206	63	220
EGC-80-...-1HR-PN														-
EGC-80-...-C-1HL-PN														220
EGC-80-...-C-1HR-PN														-
EGC-80-...-2H-PN												292		306
EGC-80-...-C-2H-PN														

Data sheet

Dimensions

Download CAD data → www.festo.com

1HL/1HR/2H – With clamping unit

Size 120/185

1-channel, left

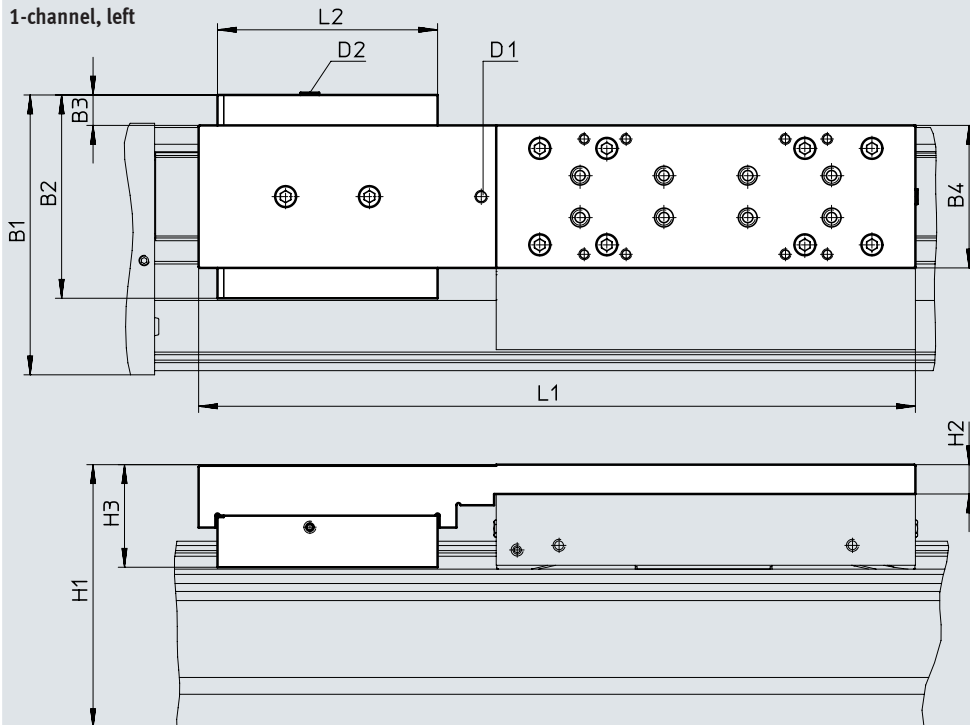

1-channel, right

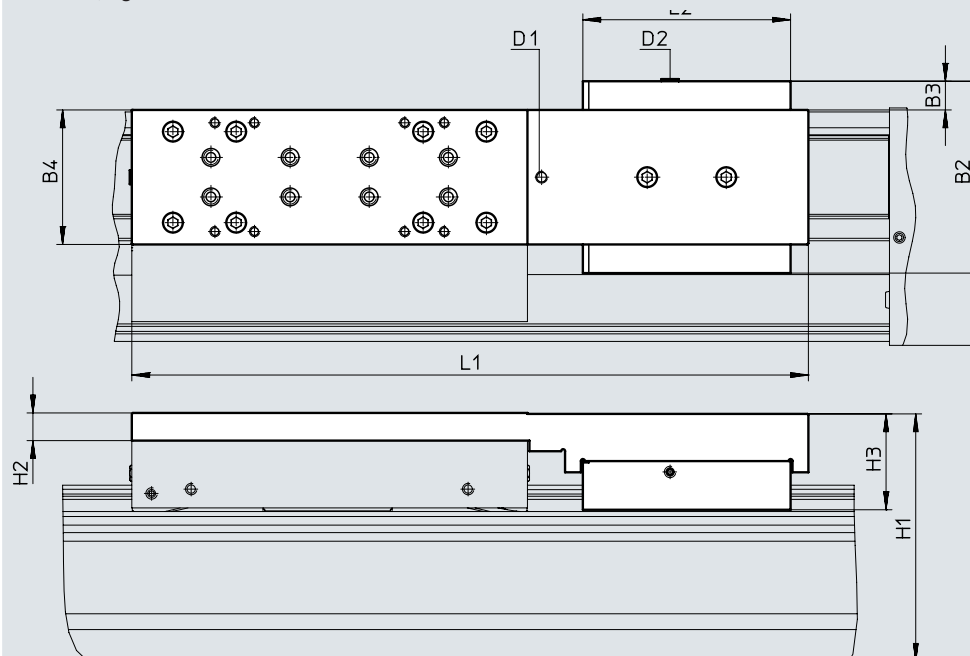

D1 Optional: threaded connection for lubrication adapter

D2 Compressed air supply ports

Working stroke reduction in combination with clamping unit → page 23

Data sheet

Dimensions

Download CAD data → www.festo.com

1HL/1HR/2H – With clamping unit

Size 120/185

2-channel

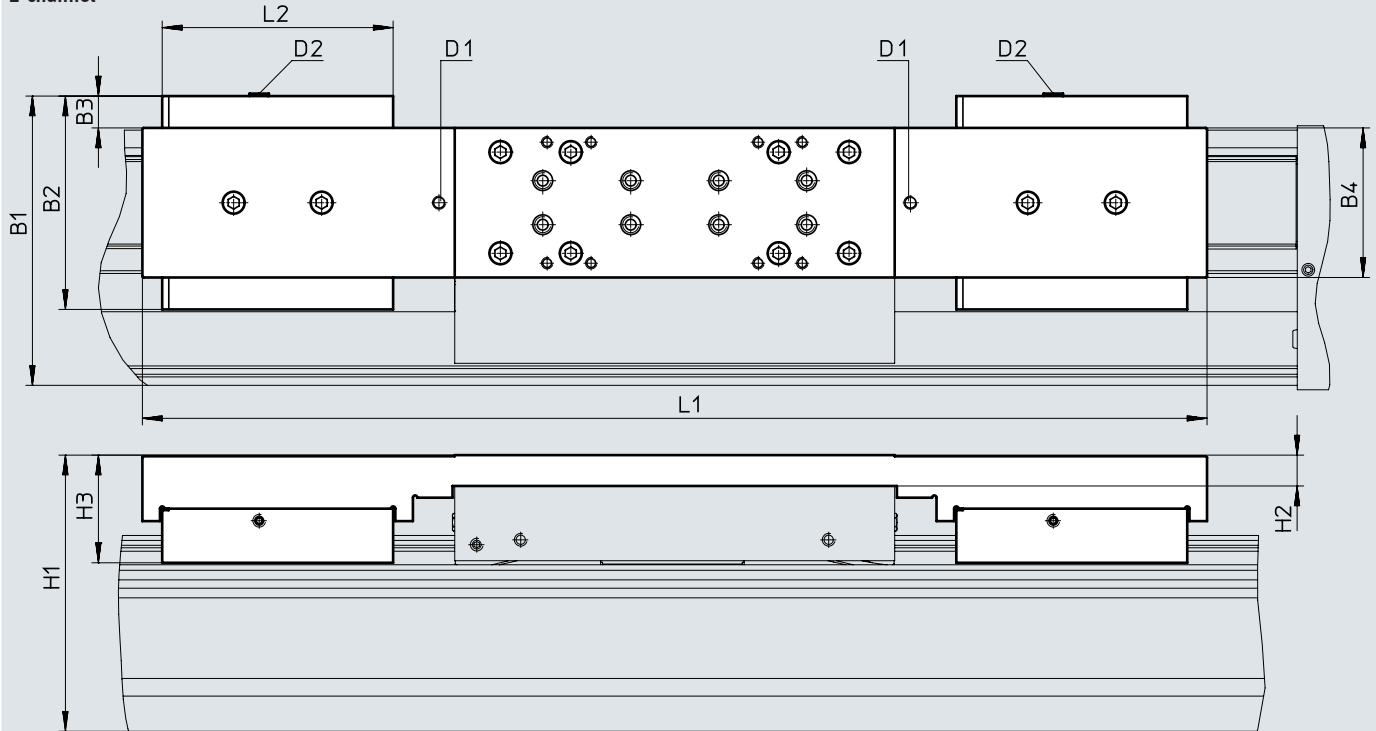

- D1 Optional: threaded connection for lubrication adapter
- D2 Compressed air supply ports

Working stroke reduction in combination with clamping unit → page 23

Type	B1	B2	B3	B4	H1	H2	H3	D1	D2	L1	L2
Size 120											
EGC-120-...-1HL-PN	133.5	97	15.5	68	125.5	14	48.9	M6	M5	342	105
EGC-120-...-1HR-PN											
EGC-120-...-C-1HL-PN											
EGC-120-...-C-1HR-PN											
EGC-120-...-2H-PN										484	
EGC-120-...-C-2H-PN											
Size 185											
EGC-185-...-1HL-PN	196.5	131	12.5	108	189.5	17	64.1	M6	M5	432	109
EGC-185-...-1HR-PN											
EGC-185-...-C-1HL-PN											
EGC-185-...-C-1HR-PN											
EGC-185-...-2H-PN										584	
EGC-185-...-C-2H-PN											

Data sheet

Ordering data

Key features:

- Stroke reserve: 0 mm
- Motor attachment position: left
- Standard slide

Size	Stroke [mm]	Part no.	Type
70	Spindle pitch 10 mm/rev		
	100	★ 3013388	EGC-70-100-BS-10P-KF-0H-ML-GK
	200	★ 3013389	EGC-70-200-BS-10P-KF-0H-ML-GK
	300	★ 3013390	EGC-70-300-BS-10P-KF-0H-ML-GK
	400	★ 3013391	EGC-70-400-BS-10P-KF-0H-ML-GK
	500	★ 3013392	EGC-70-500-BS-10P-KF-0H-ML-GK
	600	★ 3013393	EGC-70-600-BS-10P-KF-0H-ML-GK
80	Spindle pitch 10 mm/rev		
	100	★ 3013532	EGC-80-100-BS-10P-KF-0H-ML-GK
	200	★ 3013533	EGC-80-200-BS-10P-KF-0H-ML-GK
	300	★ 3013534	EGC-80-300-BS-10P-KF-0H-ML-GK
	400	★ 3013535	EGC-80-400-BS-10P-KF-0H-ML-GK
	500	★ 3013536	EGC-80-500-BS-10P-KF-0H-ML-GK
	600	★ 3013537	EGC-80-600-BS-10P-KF-0H-ML-GK
	800	★ 3013538	EGC-80-800-BS-10P-KF-0H-ML-GK
	Spindle pitch 20 mm/rev		
	100	★ 3013539	EGC-80-100-BS-20P-KF-0H-ML-GK
	200	★ 3013540	EGC-80-200-BS-20P-KF-0H-ML-GK
	300	★ 3013541	EGC-80-300-BS-20P-KF-0H-ML-GK
	400	★ 3013542	EGC-80-400-BS-20P-KF-0H-ML-GK
	500	★ 3013543	EGC-80-500-BS-20P-KF-0H-ML-GK
	600	★ 3013544	EGC-80-600-BS-20P-KF-0H-ML-GK
	800	★ 3013545	EGC-80-800-BS-20P-KF-0H-ML-GK
	120	Spindle pitch 10 mm/rev	
100		★ 3013571	EGC-120-100-BS-10P-KF-0H-ML-GK
200		★ 3013572	EGC-120-200-BS-10P-KF-0H-ML-GK
300		★ 3013573	EGC-120-300-BS-10P-KF-0H-ML-GK
400		★ 3013574	EGC-120-400-BS-10P-KF-0H-ML-GK
500		★ 3013575	EGC-120-500-BS-10P-KF-0H-ML-GK
600		★ 3013576	EGC-120-600-BS-10P-KF-0H-ML-GK
800		★ 3013577	EGC-120-800-BS-10P-KF-0H-ML-GK
Spindle pitch 25 mm/rev			
100		★ 3013578	EGC-120-100-BS-25P-KF-0H-ML-GK
200		★ 3013579	EGC-120-200-BS-25P-KF-0H-ML-GK
300		★ 3013580	EGC-120-300-BS-25P-KF-0H-ML-GK
400		★ 3013581	EGC-120-400-BS-25P-KF-0H-ML-GK
500		★ 3013582	EGC-120-500-BS-25P-KF-0H-ML-GK
600		★ 3013583	EGC-120-600-BS-25P-KF-0H-ML-GK
800		★ 3013584	EGC-120-800-BS-25P-KF-0H-ML-GK

Festo core product range

- ★ Generally ready for shipping ex works in 24 hours
- ★ Generally ready for shipping ex works in 5 days

Ordering data – Modular product system

Orientation guide

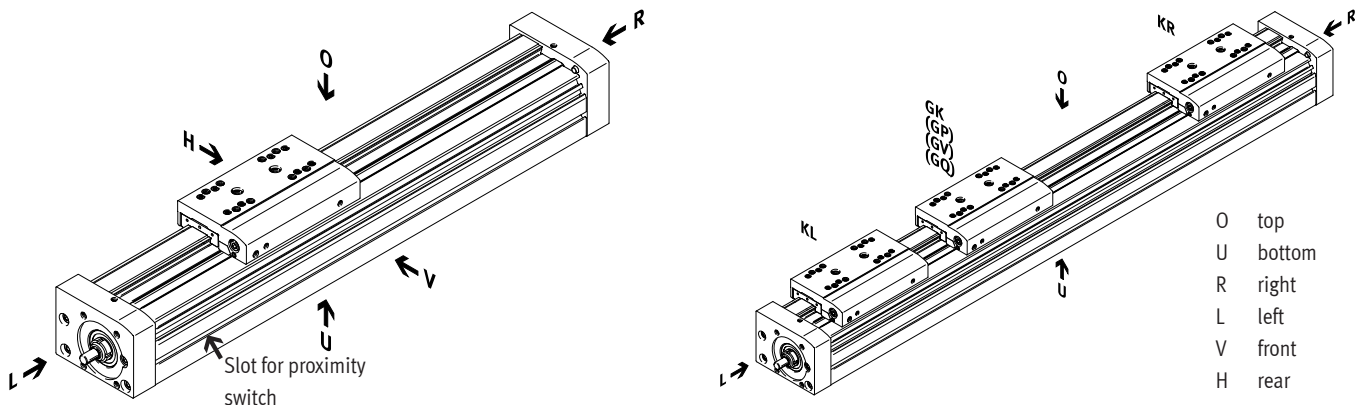

Accessories

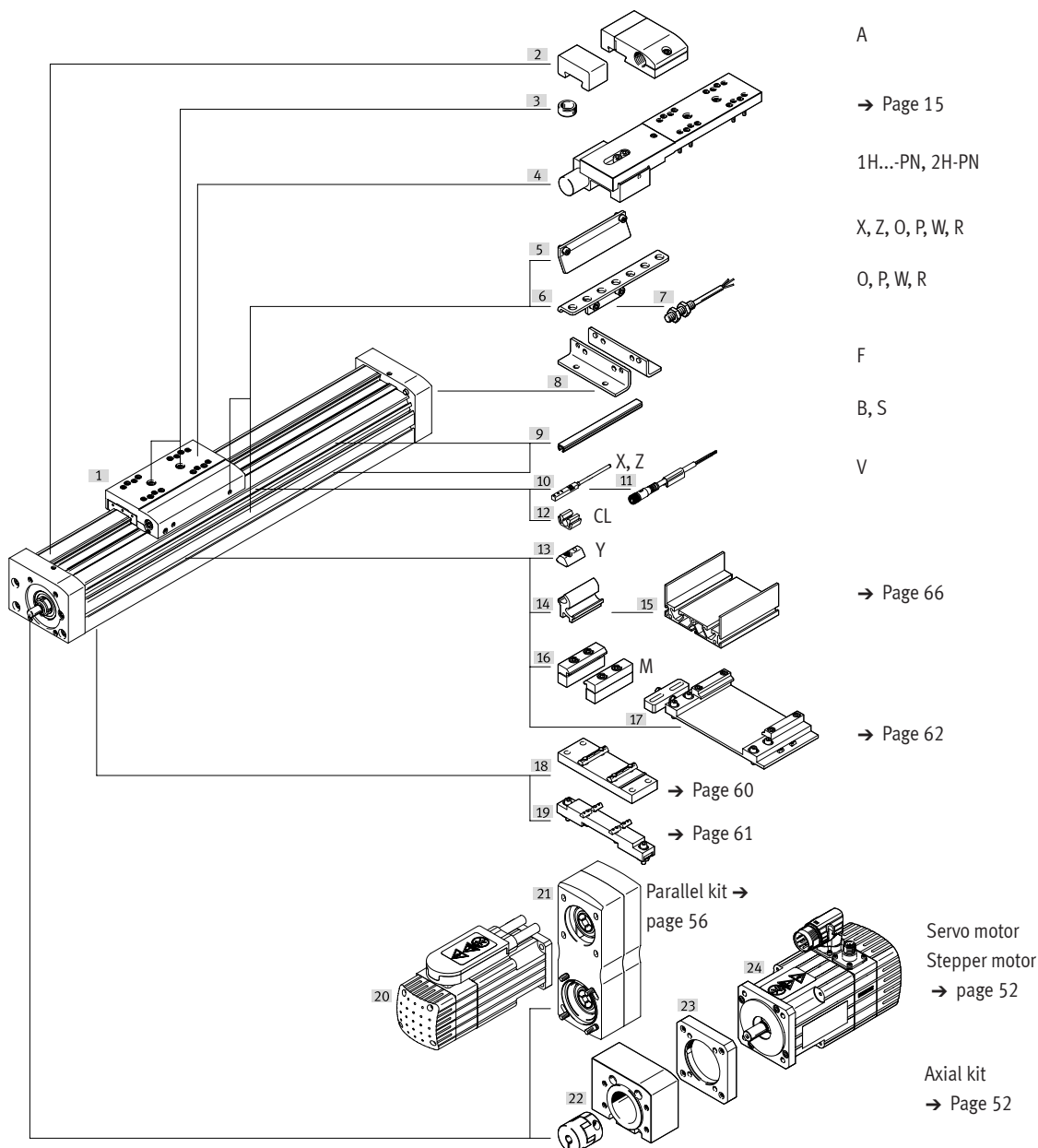

Ordering data – Modular product system

Ordering table									
Size		70	80	120	185	Condi- tions	Code	Enter code	
Module no.		556807	556808	556809	556811				
Design		Linear axis					EGC	EGC	
Size		70	80	120	185		-...		
Stroke length for GK, GP (without stroke reserve)	Standard	[mm]	100, 200, 300, 400, 500, 600, 700, 800, 1000	100, 200, 300, 400, 500, 600, 700, 800, 900, 1000, 1400, 1500, 1800, 2000	100, 200, 300, 400, 500, 600, 700, 800, 900, 1000, 1400, 1500, 2000, 2500	300, 500, 600, 1000, 1500, 2000, 2500, 3000	-...	-...	
	Variable	[mm]	50 ... 980	50 ... 1980	50 ... 2480	50 ... 2980			
Stroke length for GV, GQ (without stroke reserve)	Standard	[mm]	100, 200, 300, 400, 500, 600, 700, 900	100, 200, 300, 400, 500, 600, 700, 800, 900, 1300, 1400, 1700, 1900	100, 200, 300, 400, 500, 600, 700, 800, 900, 1300, 1400, 1900, 2400	200, 400, 500, 900, 1400, 1900, 2400, 2900	-...		
	Variable	[mm]	50 ... 880	50 ... 1880	50 ... 2380	50 ... 2880			
Function		Ball screw drive					-BS	-BS	
Spindle pitch			10	10	10	-	-10P		
			-	20	-	-	-20P		
			-	-	25	-	-25P		
			-	-	-	40	-40P		
Spindle support			None						
			With spindle support				[1]	-S	
			> 705 mm ¹⁾ > 605 mm ²⁾	> 780 mm ¹⁾ > 680 mm ²⁾	> 883 mm ¹⁾ > 783 mm ²⁾	> 1224 mm ¹⁾ > 1124 mm ²⁾			
Guide		Recirculating ball bearing guide					-KF	-KF	
Stroke reserve	[mm]	0 ... 999 (0 = no stroke reserve)				[2]	-...H		
Motor attachment position		Motor on left					-ML		
		Motor on right					-MR		
Slide		Standard slide					-GK		
		Extended slide, protected				-	-GQ		
		Standard slide, protected				-	-GP		
		Extended slide					-GV		

[1] S Only available at or above the specified strokes

1) In combination with slide GK, GP

2) In combination with slide GQ, GV

[2] ...H The sum of nominal stroke and 2x stroke reserve must not exceed the maximum stroke length

 **Note**

Spindle support enables maximum travel speed with all stroke lengths

Ordering data – Modular product system

Ordering table		70	80	120	185	Condi- tions	Code	Enter code
Additional slide	Left	Additional slide, standard, left				[3]	-KL	
	Right	Additional slide, standard, right				[3]	-KR	
Lubrication function		Standard						
		Lubrication adapter				[4]	-C	
Displacement encoder, incremental		None						
		Resolution: 2.5 µm					-M1	
		Resolution: 10 µm					-M2	
Clamping unit	-	None						
	-	1-channel, left				[5]	-1HL	
	-	1-channel, right				[5]	-1HR	
	-	2-channel				[5]	-2H	
Actuation type	-	None						
	-	Pneumatic					-PN	
Accessories		Accessories enclosed separately					ZUB-	ZUB-
Foot mounting		1					F	
Profile mounting		1 ... 50					...M	
Cover	Mounting slot	1 ... 50 (1 = 2 units, 500 mm length)					...B	
	Sensor slot	1 ... 50 (1 = 2 units, 500 mm length)					...S	
Slot nut for mounting slot		1 ... 99					...Y	
Proximity switch (SIES), inductive, slot type 8, PNP, incl. switch lug	N/O contact, 7.5 m cable	1 ... 6					...X	
	N/C contact, 7.5 m cable	1 ... 6					...Z	
Emergency buffer with retaining bracket		1 ... 2				[6]	...A	
Proximity switch (SIEN), inductive, M8, PNP, incl. switch lug with sensor bracket	N/O contact, 2.5 m cable	1 ... 99					...O	
	N/C contact, 2.5 m cable	1 ... 99					...P	
	N/O contact, M8 plug	1 ... 99					...W	
	N/C contact, M8 plug	1 ... 99					...R	
Connecting cable 2.5 m M8, 3-wire		1 ... 99					...V	
Cable clip		10, 20, 30, 40, 50, 60, 70, 80, 90					...CL	

- [3] KL, KR
If the protected slide variant (GQ, GP) is selected, the additional slide (KL, KR) is also protected
If the extended slide variant (GQ, GV) is selected, the additional slide (KL, KR) is not extended
If the slide with lubrication adapter (GK-C, GV-C) is selected, the additional slide (KL, KR) is also supplied with lubrication adapter
Working stroke reduction in combination with additional slide (KL, KR) → page 22
- [4] C
Not with standard slide, protected GP and extended slide, protected GQ
- [5] 1HL, 1HR, 2H
Not with slide GQ, GV nor with additional slide KL, KR
Only with PN
Working stroke reduction in combination with clamping unit (1HL, 1HR, 2H) → page 23
- [6] ... A
Emergency buffer with retaining bracket A cannot be combined with slide GP, GQ, GK-C, GV-C and clamping unit 1H...PN, 2H-PN

**Note**

The code X, Z includes a switch lug in the scope of delivery.

The code O, P, W, R includes one switch lug and max. two sensor brackets in the scope of delivery.

Accessories

 **Note**

Depending on the combination of motor and drive, it may not be possible to reach the maximum feed force of the drive.

When using parallel kits, the no-load driving torque of the particular kit must be taken into consideration.

Permissible axis/motor combinations with axial kit

Data sheets → Internet: eamm-a

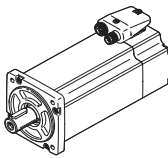
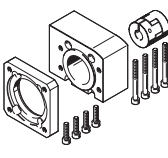
Motor/gear unit ¹⁾	Axial kit	
		• Kits for third-party motors → Internet: eamm-a
Type	Part no.	Type
EGC-70		
With servo motor		
EMME-AS-40-...	★ 3637972	EAMM-A-S38-40P-G2
EMMT-AS-60-..., EMME-AS-60-...	★ 3637958	EAMM-A-S38-60P-G2
With servo motor and gear unit		
EMME-AS-40-... EMGA-40-P-G-...-EAS-40	1456647	EAMM-A-S38-40G-G2
With stepper motor		
EMMS-ST-42-...	★ 3637965	EAMM-A-S38-42A-G2
EMMS-ST-57-...	★ 3637956	EAMM-A-S38-57A-G2
With stepper motor and gear unit		
EMMS-ST-42-... EMGA-40-P-G-...-SST-42	1456647	EAMM-A-S38-40G-G2
With integrated drive		
EMCA-EC-67-...	1456638	EAMM-A-S38-67A-G2
With integrated drive and gear unit		
EMCA-EC-67-... EMGC-40-...	1456647	EAMM-A-S38-40G-G2
EGC-80		
With servo motor		
EMMT-AS-60-..., EMME-AS-60-...	★ 3637964	EAMM-A-S48-60P-G2
With servo motor and gear unit		
EMME-AS-40-... EMGA-40-P-G-...-EAS-40	1456650	EAMM-A-S48-40G-G2
EMMT-AS-60-..., EMME-AS-60-... EMGA-60-P-G-...-EAS-60	1456652	EAMM-A-S48-60H-G2
With stepper motor		
EMMS-ST-57-...	★ 3637963	EAMM-A-S48-57A-G2
EMMS-ST-87-...	★ 3637962	EAMM-A-S48-87A-G2
With stepper motor and gear unit		
EMMS-ST-42-... EMGA-40-P-G-...-SST-42	1456650	EAMM-A-S48-40G-G2
EMMS-ST-57-... EMGA-60-P-G-...-SST-57	2256701	EAMM-A-S48-60G-G2
With integrated drive and gear unit		
EMCA-EC-67-... EMGC-40	1456650	EAMM-A-S48-40G-G2
EMCA-EC-67-... EMGC-60-...	1456652	EAMM-A-S48-60H-G2

1) The input torque must not exceed the max. permissible transferable torque of the axial kit.

Festo core product range



Generally ready for shipping ex works in 24 hours

Generally ready for shipping ex works in 5 days

Accessories

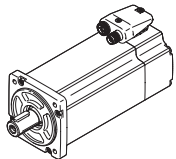
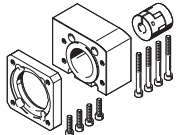
Permissible axis/motor combinations with axial kit		Data sheets → Internet: eamm-a	
Motor/gear unit ¹⁾	Axial kit		
	 <ul style="list-style-type: none"> Kits for third-party motors → Internet: eamm-a 		
Type	Part no.	Type	
EGC-120			
With servo motor			
EMMT-AS-80-..., EMME-AS-80-...	★ 3637970	EAMM-A-S62-80P-G2	
EMMT-AS-100-..., EMME-AS-100-...	★ 3637960	EAMM-A-S62-100A-G2	
EMMT-AS-150-...	★ 8157272	EAMM-A-S62-150A-G2	
With servo motor and gear unit			
EMMT-AS-60-..., EMME-AS-60-... EMGA-60-P-G...-EAS-60	1456654	EAMM-A-S62-60H-G2	
EMMT-AS-80-..., EMME-AS-80-... EMGA-80-P-G...-EAS-80	1972530	EAMM-A-S62-80G-G2	
EMMT-AS-100-..., EMME-AS-100-... EMGA-80-P-G...-SAS-100	1972530	EAMM-A-S62-80G-G2	
With stepper motor			
EMMS-ST-87-...	★ 3637966	EAMM-A-S62-87A-G2	
With stepper motor and gear unit			
EMMS-ST-57-... EMGA-60-P-G...-SST-57	2297649	EAMM-A-S62-60G-G2	
EMMS-ST-87-... EMGA-80-P-G...-SST-87	1972530	EAMM-A-S62-80G-G2	
With integrated drive and gear unit			
EMCA-EC-67-... EMGC-60-...	1456654	EAMM-A-S62-60H-G2	
EGC-185			
With servo motor			
EMMT-AS-100-..., EMME-AS-100-...	3637955	EAMM-A-S95-100A-G2	
EMMT-AS-150-...	8157279	EAMM-A-S95-150A-G2	

1) The input torque must not exceed the max. permissible transferable torque of the axial kit.



Festo core product range



Generally ready for shipping ex works in 24 hours

Generally ready for shipping ex works in 5 days

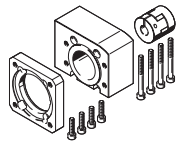
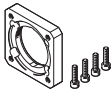
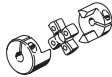
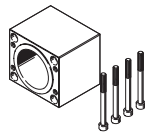
Accessories

Individual components of the axial kit				
Axial kit	Comprising:			
	Motor flange	Coupling	Coupling housing	Screw set
				
Part no. Type	Part no. Type	Part no. Type	Part no. Type	Part no. Type
EGC-70				
3637971 EAMM-A-S38-40A-G2	558175 EAMF-A-38B-40A	558312 EAMC-30-32-6-6	3637942 EAMK-A-S38-38A/B-G2	–
1456647 EAMM-A-S38-40G-G2	1460097 EAMF-A-38A-40G	562681 EAMC-30-32-6-10	3637942 EAMK-A-S38-38A/B-G2	567488 EAHM-L2-M5-50
★ 3637972 EAMM-A-S38-40P-G2	2219077 EAMF-A-38B-40P	533708 EAMC-30-32-6-8	3637942 EAMK-A-S38-38A/B-G2	–
★ 3637965 EAMM-A-S38-42A-G2	560691 EAMF-A-38B-42A	561333 EAMC-30-32-5-6	3637942 EAMK-A-S38-38A/B-G2	–
3637967 EAMM-A-S38-55A-G2	558176 EAMF-A-38A-55A	551003 EAMC-30-32-6-9	3637942 EAMK-A-S38-38A/B-G2	567488 EAHM-L2-M5-50
★ 3637956 EAMM-A-S38-57A-G2	560692 EAMF-A-38A-57A	551002 EAMC-30-32-6-6.35	3637942 EAMK-A-S38-38A/B-G2	567488 EAHM-L2-M5-50
★ 3637958 EAMM-A-S38-60P-G2	1987412 EAMF-A-38A-60P	1233256 EAMC-30-32-6-14	3637942 EAMK-A-S38-38A/B-G2	567489 EAHM-L2-M5-55
1456638 EAMM-A-S38-67A-G2	1490100 EAMF-A-38A-67A	551003 EAMC-30-32-6-9	3637942 EAMK-A-S38-38A/B-G2	567489 EAHM-L2-M5-55
EGC-80				
1456650 EAMM-A-S48-40G-G2	4067069 EAMF-A-48B-40G	558029 EAMC-30-32-8-10	3637941 EAMK-A-S48-48A/B-G2	–
3637961 EAMM-A-S48-55A-G2	558177 EAMF-A-48B-55A	543423 EAMC-30-32-8-9	3637941 EAMK-A-S48-48A/B-G2	–
★ 3637963 EAMM-A-S48-57A-G2	560694 EAMF-A-48B-57A	543421 EAMC-30-32-6.35-8	3637941 EAMK-A-S48-48A/B-G2	–
2256701 EAMM-A-S48-60G-G2	558019 EAMF-A-48A-60G/H	551004 EAMC-30-32-8-11	3637941 EAMK-A-S48-48A/B-G2	567489 EAHM-L2-M5-55
1456652 EAMM-A-S48-60H-G2	558019 EAMF-A-48A-60G/H	562682 EAMC-30-32-8-14	3637941 EAMK-A-S48-48A/B-G2	567489 EAHM-L2-M5-55
★ 3637964 EAMM-A-S48-60P-G2	2220620 EAMF-A-48A-60P	562682 EAMC-30-32-8-14	3637941 EAMK-A-S48-48A/B-G2	567489 EAHM-L2-M5-55
3637957 EAMM-A-S48-70A-G2	558025 EAMF-A-48A-70A	551004 EAMC-30-32-8-11	3637941 EAMK-A-S48-48A/B-G2	567488 EAHM-L2-M5-50
★ 3637962 EAMM-A-S48-87A-G2	560695 EAMF-A-48A-87A	551004 EAMC-30-32-8-11	3637941 EAMK-A-S48-48A/B-G2	567489 EAHM-L2-M5-55

Festo core product range





Generally ready for shipping ex works in 24 hours

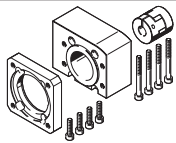
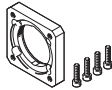
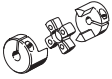
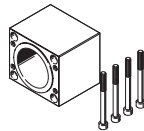

Generally ready for shipping ex works in 5 days

Accessories

Individual components of the axial kit				
Axial kit	Comprising:			
	Motor flange	Coupling	Coupling housing	Screw set
				
Part no. Type	Part no. Type	Part no. Type	Part no. Type	Part no. Type
EGC-120				
2297649 EAMM-A-S62-60G-G2	1460112 EAMF-A-62A-60G/H	525864 EAMC-40-66-11-12	3637940 EAMK-A-S62-62A/B-G2	567495 EAHM-L2-M6-90
1456654 EAMM-A-S62-60H-G2	1460112 EAMF-A-62A-60G/H	1452803 EAMC-40-66-12-14	3637940 EAMK-A-S62-62A/B-G2	567495 EAHM-L2-M6-90
3637959 EAMM-A-S62-70A-G2	558179 EAMF-A-62B-70A	558313 EAMC-42-66-11-12	3637940 EAMK-A-S62-62A/B-G2	–
1972530 EAMM-A-S62-80G-G2	2116672 EAMF-A-62B-80G	2138701 EAMC-42-50-12-20	3637940 EAMK-A-S62-62A/B-G2	–
★ 3637970 EAMM-A-S62-80P-G2	2222624 EAMF-A-62B-80P	551005 EAMC-42-50-12-19	3637940 EAMK-A-S62-62A/B-G2	–
★ 3637966 EAMM-A-S62-87A-G2	560696 EAMF-A-62B-87A	558313 EAMC-42-66-11-12	3637940 EAMK-A-S62-62A/B-G2	–
★ 3637960 EAMM-A-S62-100A-G2	558026 EAMF-A-62A-100A	551005 EAMC-42-50-12-19	3637940 EAMK-A-S62-62A/B-G2	567494 EAHM-L2-M6-80
3637969 EAMM-A-S62-140A-G2	558022 EAMF-A-62A-140A	558314 EAMC-42-50-12-24	3637940 EAMK-A-S62-62A/B-G2	567495 EAHM-L2-M6-90
EGC-185				
3637955 EAMM-A-S95-100A-G2	558182 EAMF-A-95B-100A	558315 EAMC-56-58-19-25	3637939 EAMK-A-S95-95A/B-G2	–
3637954 EAMM-A-S95-140A-G2	558023 EAMF-A-95A-140A	558316 EAMC-56-58-24-25	3637939 EAMK-A-S95-95A/B-G2	567498 EAHM-L2-M8-100

Festo core product range



Generally ready for shipping ex works in 24 hours

Generally ready for shipping ex works in 5 days

Accessories

Data sheets → Internet: eamm-u

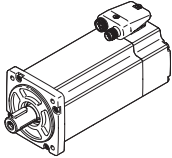
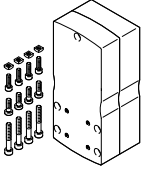
Permissible axis/motor combinations with parallel kit		
Motor/gear unit ¹⁾	Parallel kit	
		<ul style="list-style-type: none"> The kit can be mounted in all directions To support the axis shaft, a counter bearing EAMG and a clamping sleeve EAMH-...-P with integrated trunnion are included in the scope of delivery for the parallel kit. Additional information → eamm-u Kits for third-party motors → Internet: eamm-u
Type	Part no.	Type
EGC-70-...-BS		
With servo motor		
EMME-AS-40-...	★ 2155239	EAMM-U-50-S38-40P-78
With stepper motor		
EMMS-ST-42-...	★ 1217945	EAMM-U-50-S38-42A-78
EMMS-ST-57-...	★ 1218568	EAMM-U-60-S38-57A-91
With servo motor and gear unit		
EMME-AS-40-... EMGA-40-P-...	2283732	EAMM-U-60-S38-40G-91
With stepper motor and gear unit		
EMMS-ST-42-... EMGA-40-P-...	2283732	EAMM-U-60-S38-40G-91
With integrated drive and gear unit		
EMCA-EC-67-... EMGC-40-P-...	2283732	EAMM-U-60-S38-40G-91
EGC-80-...-BS		
With servo motor		
EMMT-AS-60-..., EMME-AS-60-...	★ 2629253	EAMM-U-70-S48-60P-96
With stepper motor		
EMMS-ST-57-...	★ 1219379	EAMM-U-60-S48-57A-91
EMMS-ST-87-...	★ 1217604	EAMM-U-86-S48-87A-177
With servo motor and gear unit		
EMME-AS-40-... EMGA-40-P-...	2283760	EAMM-U-60-S48-40G-91
EMMT-AS-60-..., EMME-AS-60-... EMGA-60-P-...-EAS ²⁾	2801715	EAMM-U-70-S48-60H-96
	1587338	EAMM-U-86-S48-60H-102
With stepper motor and gear unit		
EMMS-ST-42-... EMGA-40-P-...-SST ²⁾	2283760	EAMM-U-60-S48-40G-91
EMMS-ST-57-... EMGA-60-P-...-SST ²⁾	2801627	EAMM-U-70-S48-60G-96
	1587251	EAMM-U-86-S48-60G-102
With integrated drive and gear unit		
EMCA-EC-67-... EMGC-40-P-...	2283760	EAMM-U-60-S48-40G-91
EMCA-EC-67-... EMGC-60-P-... ²⁾	2801715	EAMM-U-70-S48-60H-96
	1587338	EAMM-U-86-S48-60H-102

1) The input torque must not exceed the max. permissible transferable torque of the parallel kit.

2) Gear unit output shaft diameter: EMGA-60-P-...SAS/SST: 11 mm; EMGA-60-P-...EAS, EMGC-60-P: 14 mm

Festo core product range

- ★ Generally ready for shipping ex works in 24 hours
- ★ Generally ready for shipping ex works in 5 days

Accessories

Data sheets → Internet: eamm-u

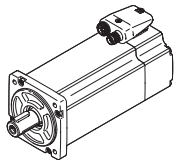
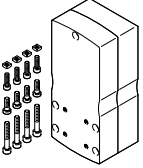
Permissible axis/motor combinations with parallel kit		
Motor/gear unit ¹⁾	Parallel kit	
		<ul style="list-style-type: none"> The kit can be mounted in all directions To support the axis shaft, a counter bearing EAMG and a clamping sleeve EAMH-...-P with integrated trunnion are included in the scope of delivery for the parallel kit. Additional information → eamm-u Kits for third-party motors → Internet: eamm-u
Type	Part no.	Type
EGC-120-...-BS		
With servo motor		
EMMT-AS-80-..., EMME-AS-80-...	★ 2157004	EAMM-U-86-S62-80P-177
EMMT-AS-100-..., EMME-AS-100-...	★ 1217381	EAMM-U-110-S62-100A-207
EMMT-AS-150-...	8157287	EAMM-U-145-S62-150A-288
With stepper motor		
EMMS-ST-87-...	★ 1217373	EAMM-U-86-S62-87A-177
With servo motor and gear unit		
EMMT-AS-60-..., EMME-AS-60-... EMGA-60-P-...-EAS ²⁾	1587453	EAMM-U-86-S62-60H-177
With stepper motor and gear unit		
EMMS-ST-57-... EMGA-60-P-...-SST ²⁾	1587411	EAMM-U-86-S62-60G-177
With integrated drive and gear unit		
EMCA-EC-67-... EMGC-60-P-... ²⁾	1587453	EAMM-U-86-S62-60H-177
EGC-185-...-BS		
With servo motor		
EMMT-AS-100-..., EMME-AS-100-...	1220656	EAMM-U-110-S95-100A-207
EMMT-AS-150-...	8157288	EAMM-U-145-S95-150A-288
With servo motor and gear unit		
EMMT-AS-80-..., EMMT-AS-100-... EMME-AS-80-..., EMME-AS-100-... EMGA-80-P-...	1589544	EAMM-U-110-S95-80G-207
With stepper motor and gear unit		
EMMS-ST-87-... EMGA-80-P-...	1589544	EAMM-U-110-S95-80G-207

1) The input torque must not exceed the max. permissible transferable torque of the parallel kit.

2) Gear unit output shaft diameter: EMGA-60-P-...SAS/SST: 11 mm; EMGA-60-P-...EAS, EMGC-60-P: 14 mm

**Note**

The clamping element EADT is required to adjust the toothed belt pretension with EAMM-U-110 and EAMM-U-145.

Festo core product range



Generally ready for shipping ex works in 24 hours

Generally ready for shipping ex works in 5 days

Accessories

Foot mounting HPE
(order code F)

Material: Galvanised steel

RoHS-compliant

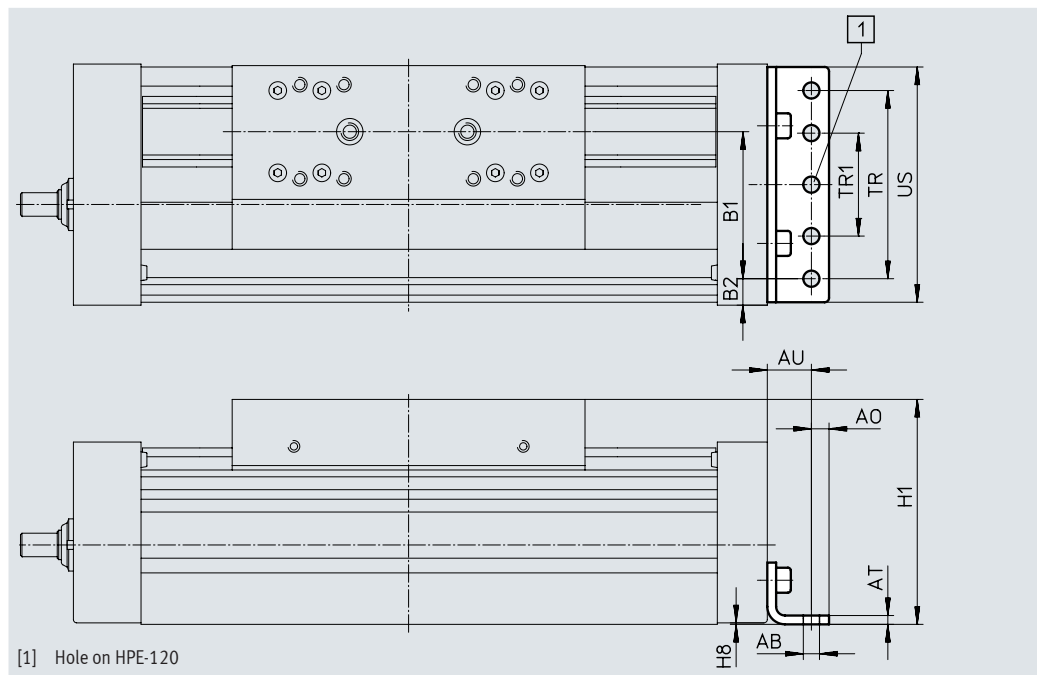

Dimensions and ordering data

For size	AB ∅	A0	AT	AU	B1	B2	H1
70	5.5	6	3	13	37	14.5	64
80	5.5	6	3	15	38	21	76.5
120	9	8	6	22	65	20	111.5
185	9	12	8	25	118	13	172.5

For size	H8	TR	TR1	Us	Weight [g]	Part no.	Type
70	0.5	40	–	67	115	558321	HPE-70
80	0.5	40	–	80	150	558322	HPE-80
120	0.6	80	–	116	578	558323	HPE-120
185	0.5	160	80	182	1438	558325	HPE-185

Accessories

Profile mounting MUE
 (order code M)

Material: Anodised aluminium

RoHS-compliant

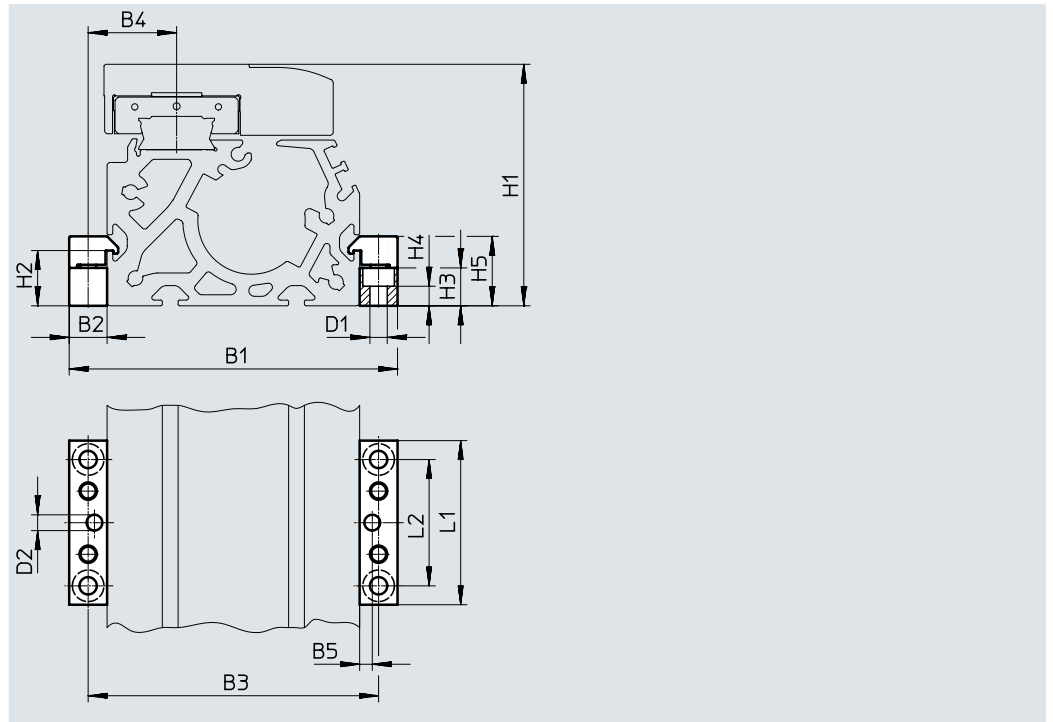
Dimensions and ordering data

For size	B1	B2	B3	B4	B5	D1 ∅	D2 ∅ H7	H1	H2
70	91	12	79	22.5	4	5.5	5	64	17.5
80	104	12	92	28	4	5.5	5	76.5	17.5
120	154	19	135	42.5	4	9	5	111.5	16
185	220	19	201	62.5	4	9	5	172.5	16

For size	H3	H4	H5	L1	L2	Weight [g]	Part no.	Type
70	12	6.2	22	52	40	80	★ 558043	MUE-70/80
80	12	6.2	22	52	40	80	★ 558043	MUE-70/80
120	14	5.5	29.5	90	40	290	★ 558044	MUE-120/185
185	14	5.5	29.5	90	40	290	★ 558044	MUE-120/185

Festo core product range

- ★ Generally ready for shipping ex works in 24 hours
- ★ Generally ready for shipping ex works in 5 days

Accessories

Central support EAHF

Material:
Anodised aluminium
RoHS-compliant

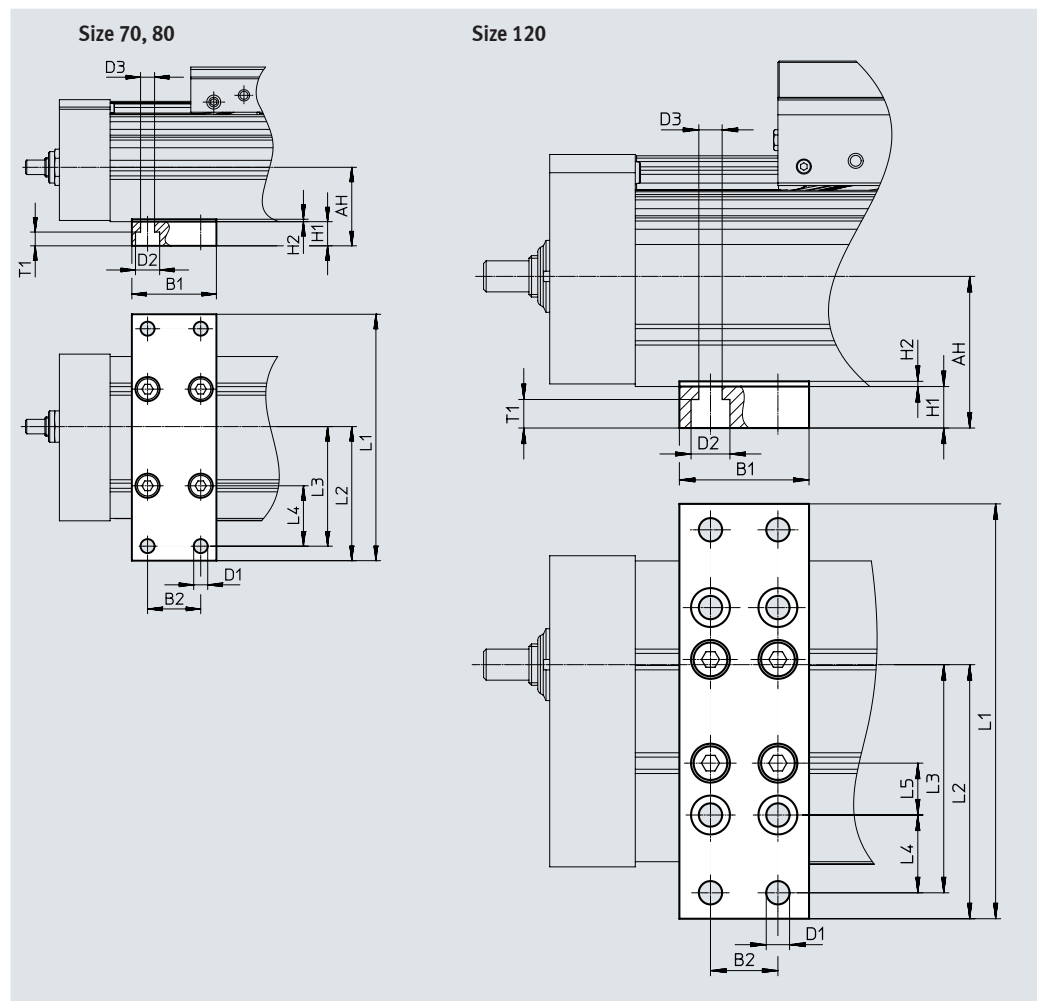

Dimensions and ordering data

For size	Ah	B1	B2	D1 ∅	D2 ∅	D3 ∅	H1	L1
70	32.5	35	22	5.8	10	5.8	10	102
80	37							112
120	58.5	50	26	9	15	9	16	160

For size	L2	L3	L4	L5	T1	Weight [g]	Part no.	Type
70	55.5	49.5	25	-	5.7	113	2349256	EAHF-L5-70-P
80	62	56	30			123	3535188	EAHF-L5-80-P
120	98	88	30	20	11	384	2410274	EAHF-L5-120-P

Accessories

Adjusting kit EADC-E15

Material:
 EADC-E15-80/120: Wrought aluminium alloy
 EADC-E15-185: Steel
 RoHS-compliant

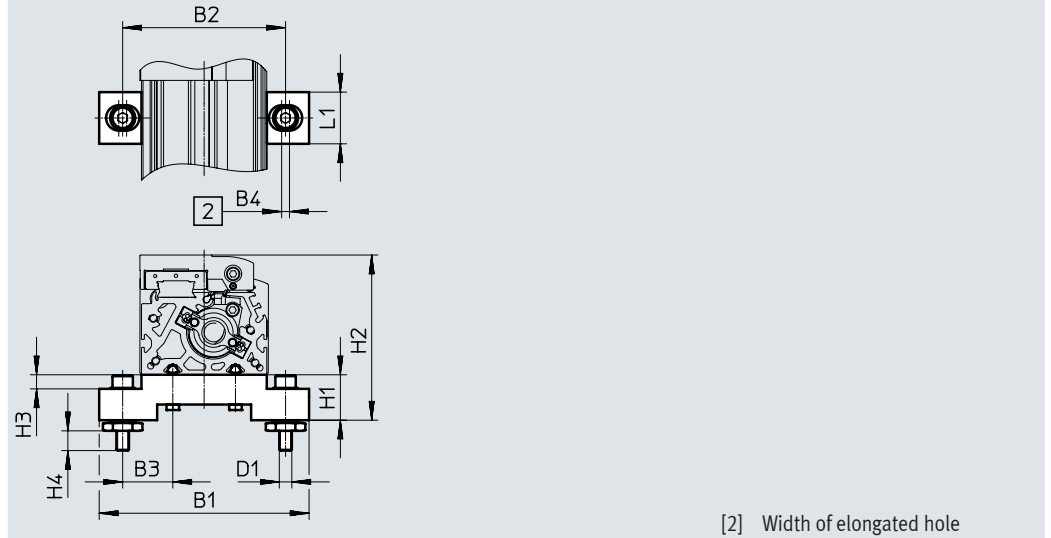
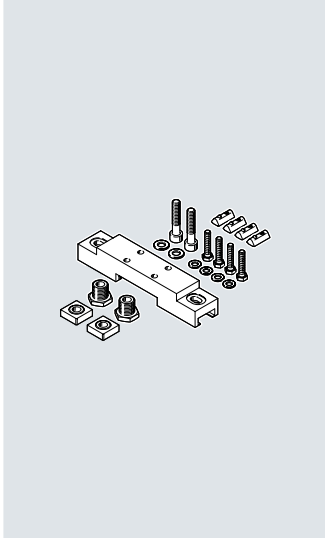

[2] Width of elongated hole

Dimensions and ordering data

For size	B1	B2	B3	B4	D1	H1
70	134	104	32	5	M8	29
80	134	104	32	5	M8	29
120	170	140	50	5	M8	29
185	236	209	64.5	5	M8	29

For size	H2	H3	H4	L1	Weight [g]	Part no.	Type
70	93	9	12.6	33	386	8047566	EADC-E15-80-E7
80	105.5	9	12.6	33	386	8047566	EADC-E15-80-E7
120	140.5	9	12.6	33	388	8047567	EADC-E15-120-E7
185	201.5	9	12.6	33	569	8047568	EADC-E15-185-E7

Accessories

Adjusting kit EADC-E16

Material:
Wrought aluminium alloy
RoHS-compliant

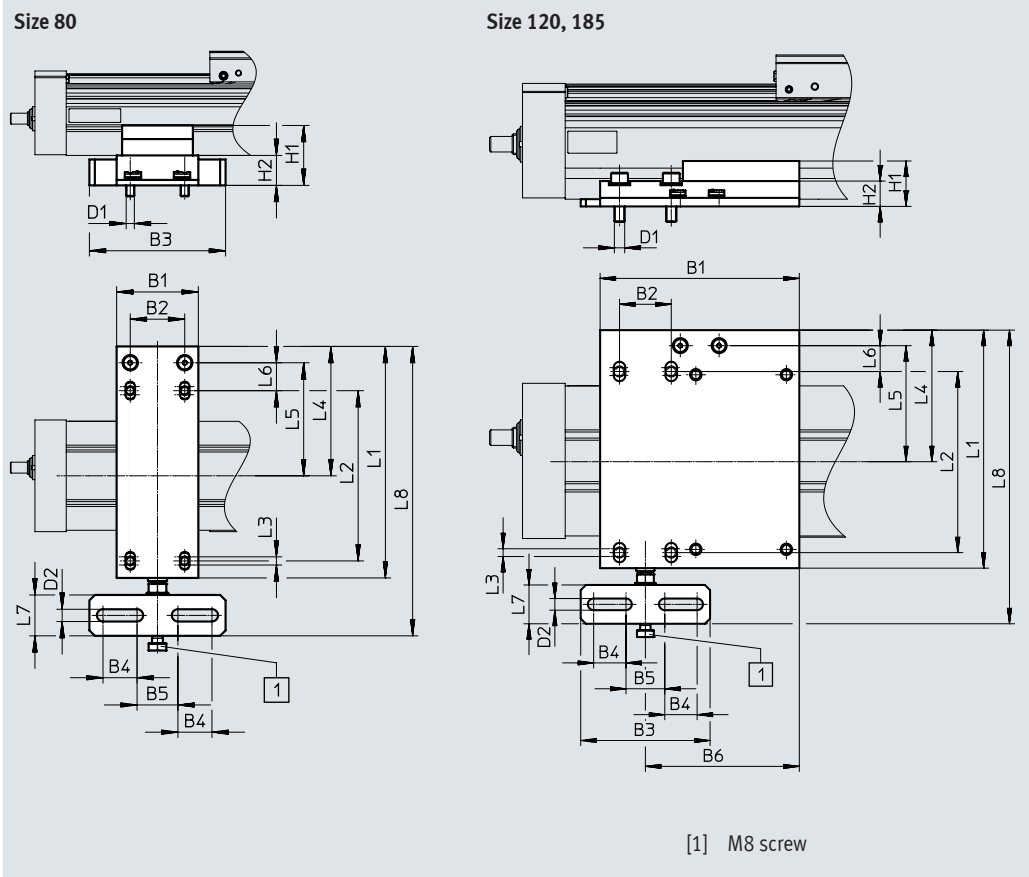
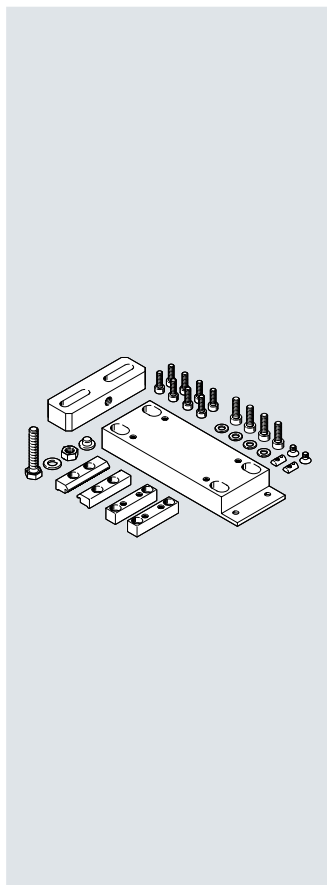

Dimensions and ordering data

For size	B1	B2	B3	B4	B5	B6	D1	D2	H1	H2	L1	L2
80	60	40	100	25	30	-	M6	9	44	22	170	125
120	154	40	100	25	30	119	M8	9	35.1	19.6	184	140
185	150	40	100	25	30	119	M8	9	35.1	19.6	272	220

For size	L3	L4	L5	L6	L7	L8	Weight [g]	Part no.	Type
80	6	95	83	20.5	30	212.5	828	8047577	EADC-E16-80-E7
120	6	101.7	89.7	20	30	227	1134	8047578	EADC-E16-120-E7
185	6	150	138	28	30	315	1457	8047579	EADC-E16-185-E7

Accessories

Shock absorber retainer KYE

Emergency buffer NPE → page 65
(order code A)

Material:
Anodised aluminium
RoHS-compliant

Cannot be used in combination with
the variants GP and GQ or GK-C, GV-C
and 1H...-PN, 2H-PN.

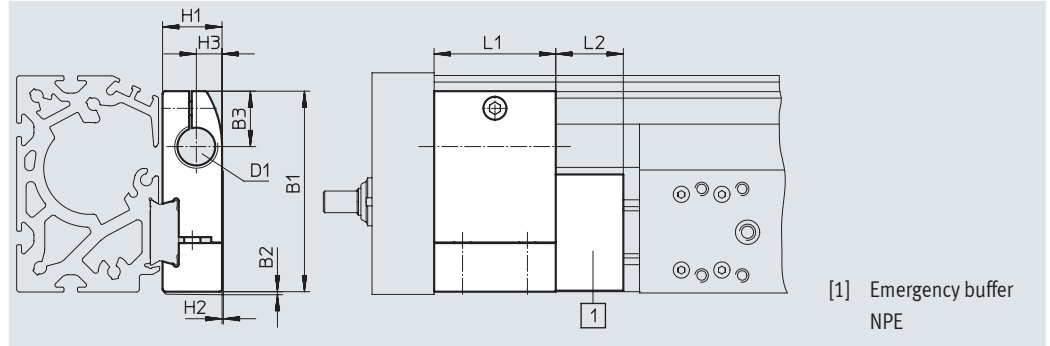

Dimensions and ordering data												
For size	B1	B2	B3	D1	H1	H2	H3	L1	L2	Weight [g]	Part no.	Type
70	57.5	1	16.5	M12X1	18.2	0.5	7.5	30	15	75	557584	KYE-70
80	74.2	1	20.5	M16X1	22	0.5	9.5	45	25	170	557585	KYE-80
120	108.5	1	26	M22X1.5	31	1	14	60	40	680	557586	KYE-120
185	168	1	37	M26X1.5	42	4	18	75	60	1075	557587	KYE-185

Switch lug SF-EGC-1

For sensing via proximity switch
SIES-8M
(order code X or Z)

Material:
Galvanised steel
RoHS-compliant

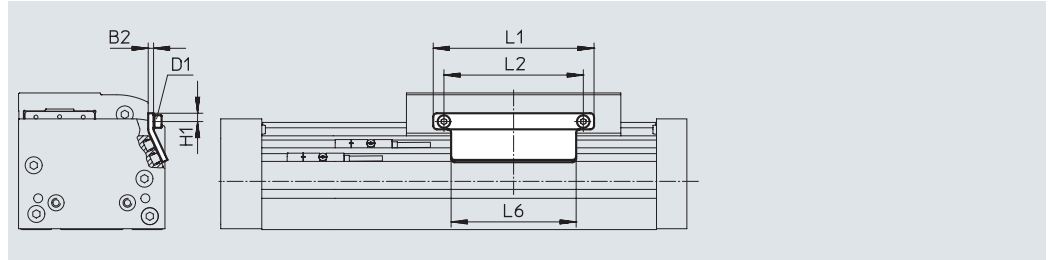

Dimensions and ordering data									
For size	B2	D1	H1	L1	L2	L6	Weight [g]	Part no.	Type
70	3	M4	4.65	70	56	50	50	★ 558047	SF-EGC-1-70
80	3	M4	4.65	90	78	70	63	★ 558048	SF-EGC-1-80
120	3	M5	8	170	140	170	147	★ 558049	SF-EGC-1-120
185	3	M5	10	230	200	230	246	★ 558051	SF-EGC-1-185

Festo core product range

- ★ Generally ready for shipping ex works in 24 hours
- ★ Generally ready for shipping ex works in 5 days

Accessories

Switch lug SF-EGC-2

For sensing via proximity switch SIEN-M8B (order code O, P, W or R) or SIES-8M (order code X or Z)

Material:

Galvanised steel
RoHS-compliant

Sensor bracket HWS-EGC

For proximity switch SIEN-M8B (order code O, P, W or R)

Material:

Galvanised steel
RoHS-compliant

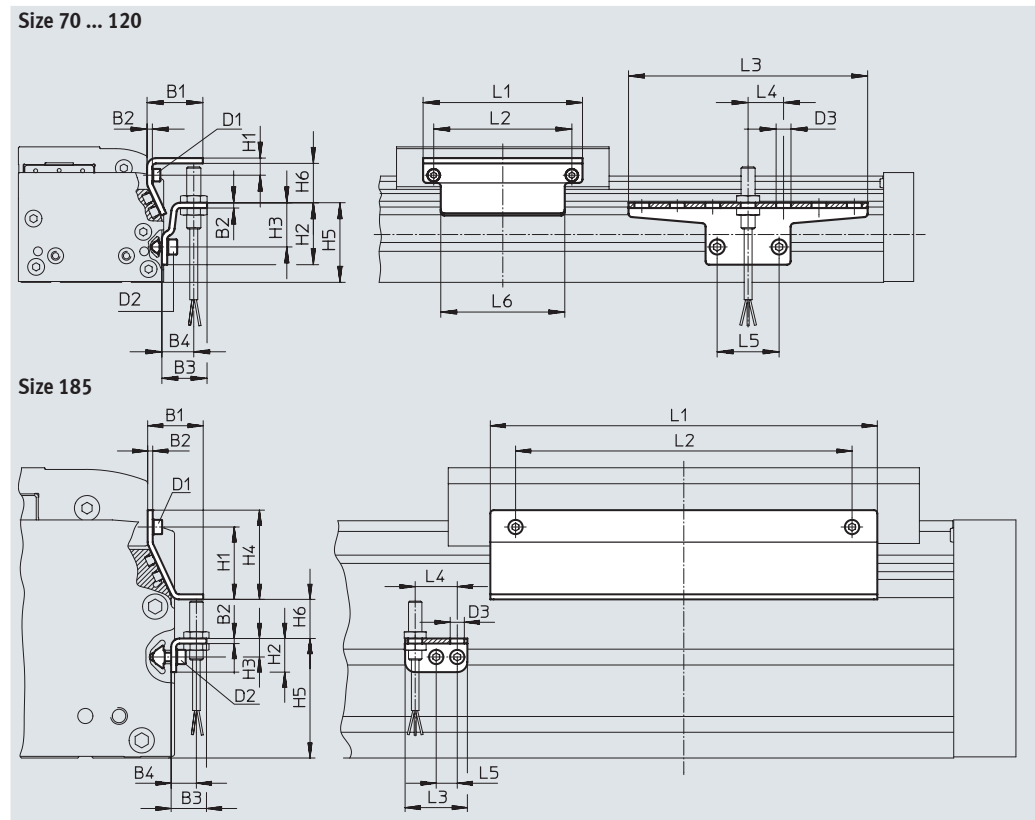
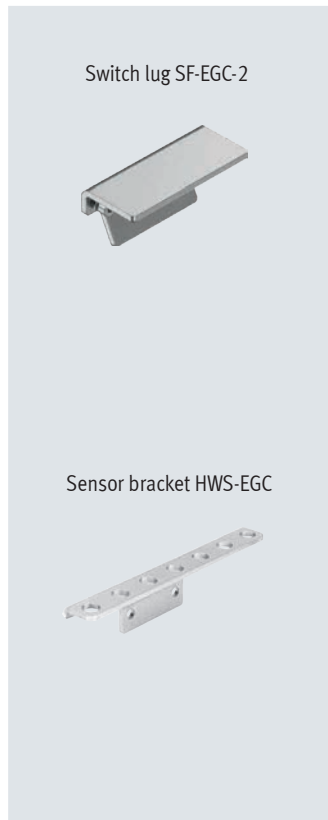

Dimensions and ordering data





For size	B1	B2	B3	B4	D1	D2	D3	H1	H2
70	31.5	3	25.5	18	M4	M5	8.4	9.5	35
80	31.5	3	25.5	18	M4	M5	8.4	9.5	35
120	32	3	25.5	18	M5	M5	8.4	13.2	65
185	33	3	25.5	15	M5	M5	8.4	43	20

For size	H3	H4	H5	H6	L1	L2	L3	L4	L5	L6
70	25	–	45	13.5	70	56	135	20	35	50
80	25	–	45	23.5	90	78	135	20	35	70
120	55	–	75	24	170	140	215	20	35	170
185	11	53	71	25.5	230	200	37	25	12.5	230

For size	Weight [g]	Part no.	Type
Switch lug			
70	100	558052	SF-EGC-2-70
80	130	558053	SF-EGC-2-80
120	277	558054	SF-EGC-2-120
185	390	558056	SF-EGC-2-185

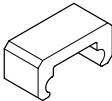
For size	Weight [g]	Part no.	Type
Sensor bracket			
70	110	558057	HWS-EGC-M5
80	110	558057	HWS-EGC-M5
120	217	570365	HWS-EGC-M8-B
185	58	560517	HWS-EGC-M8:KURZ (SHORT)

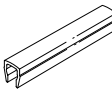
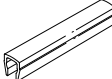
Accessories

Ordering data		For size	Description	Order code	Part no.	Type	PU ¹⁾
Emergency buffer NPE							
	70	For use in combination with shock absorber retainer KYE	A	562581	NPE-70		1
	80			562582	NPE-80		
	120			562583	NPE-120		
	185			562584	NPE-185		
Slot nut NST							
	70, 80	For mounting slot	Y	150914	NST-5-M5		1
				8047843	NST-5-M5-10		10
				8047878	NST-5-M5-50		50
	120, 185	For mounting slot	Y	150915	NST-8-M6		1
				8047868	NST-8-M6-10		10
				8047869	NST-8-M6-50		50
Centring pin/sleeve ZBS/ZBH							
	70	For slide	-	150928	ZBS-5		10
	80, 120, 185			8137184	ZBH-9-B		
Slot cover ABP							
	70, 80	For mounting slot	B	151681	ABP-5		2
	120, 185	Each 0.5 m		151682	ABP-8		
Slot cover ABP-S							
	70 ... 185	For sensor slot Each 0.5 m	S	563360	ABP-5-S1		2
Clip SMBK							
	70 ... 185	For sensor slot, for mounting the proximity switch cables	CL	534254	SMBK-8		10

1) Packaging unit

Accessories

Mounting options between axis and support profile

Depending on the adapter kit, the spacing between the axis and the support profile is:
 $x = 20 \text{ mm}$ or 50 mm

The support profile must be mounted using at least 2 adapter kits. For longer strokes, an adapter kit must be used every 500 mm .

Example

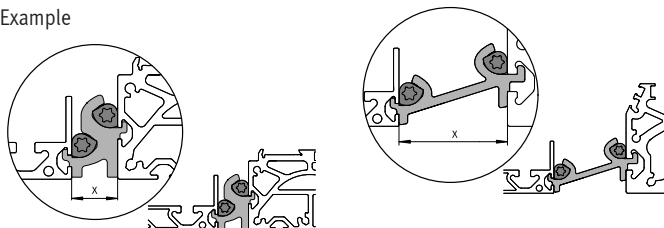

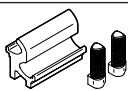
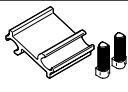
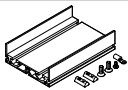



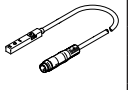
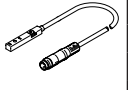

Ordering data					
	For size	Description	Part no.	Type	PU ¹⁾
Adapter kit DHAM					
	70, 80	<ul style="list-style-type: none"> For mounting the support profile on the axis Spacing between axis and profile is 20 mm 	562241	DHAM-ME-N1-CL	1
	120, 185		562242	DHAM-ME-N2-CL	
	70, 80	<ul style="list-style-type: none"> For mounting the support profile on the axis Spacing between axis and profile is 50 mm 	574560	DHAM-ME-N1-50-CL	1
	120, 185		574561	DHAM-ME-N2-50-CL	
Support profile HMIA					
	70 ... 185	<ul style="list-style-type: none"> For guiding an energy chain 	539379	HMIA-E07-	1

1) Packaging unit

Ordering data – Proximity switches for T-slot, inductive							Data sheets → Internet: sies
	Type of mounting	Electrical connection	Switching output	Cable length [m]	Order code	Part no.	Type
N/O contact							
	Inserted in the slot from above, flush with the cylinder profile	Cable, 3-wire	PNP	7.5	X	551386	SIES-8M-PS-24V-K-7.5-OE
		Plug M8x1, 3-pin		0.3	–	551387	SIES-8M-PS-24V-K-0.3-M8D
		Cable, 3-wire	NPN	7.5	–	551396	SIES-8M-NS-24V-K-7.5-OE
		Plug M8x1, 3-pin		0.3	–	551397	SIES-8M-NS-24V-K-0.3-M8D
N/C contact							
	Inserted in the slot from above, flush with the cylinder profile	Cable, 3-wire	PNP	7.5	Z	551391	SIES-8M-PO-24V-K-7.5-OE
		Plug M8x1, 3-pin		0.3	–	551392	SIES-8M-PO-24V-K-0.3-M8D
		Cable, 3-wire	NPN	7.5	–	551401	SIES-8M-NO-24V-K-7.5-OE
		Plug M8x1, 3-pin		0.3	–	551402	SIES-8M-NO-24V-K-0.3-M8D

Accessories

Ordering data – Proximity switch M8 (round design), inductive							Data sheets → Internet: sien
	Electrical connection	LED	Switching output	Cable length [m]	Order code	Part no.	Type
N/O contact							
	Cable, 3-wire	■	PNP	2.5	0	★ 150386	SIEN-M8B-PS-K-L
			NPN	2.5	–	★ 150384	SIEN-M8B-NS-K-L
	Plug M8x1, 3-pin	■	PNP	–	W	★ 150387	SIEN-M8B-PS-S-L
			NPN	–	–	★ 150385	SIEN-M8B-NS-S-L
N/C contact							
	Cable, 3-wire	■	PNP	2.5	P	150390	SIEN-M8B-PO-K-L
			NPN	2.5	–	150388	SIEN-M8B-NO-K-L
	Plug M8x1, 3-pin	■	PNP	–	R	150391	SIEN-M8B-PO-S-L
			NPN	–	–	150389	SIEN-M8B-NO-S-L

Ordering data – Connecting cables					Data sheets → Internet: nebu
	Electrical connection, left	Electrical connection, right	Cable length [m]	Part no.	Type
	Straight socket, M8x1, 3-pin	Cable, open end, 3-wire	2.5	159420	SIM-M8-3GD-2.5-PU
			2.5	★ 541333	NEBU-M8G3-K-2.5-LE3
			5.0	★ 541334	NEBU-M8G3-K-5-LE3
	Angled socket, M8x1, 3-pin	Cable, open end, 3-wire	2.5	★ 541338	NEBU-M8W3-K-2.5-LE3
			5.0	★ 541341	NEBU-M8W3-K-5-LE3

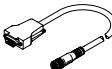
Ordering data – Encoder cables for displacement encoder system, EGC...-M1/-M2					Data sheets → Internet: nebm
	Electrical connection, left	Electrical connection, right	Cable length [m]	Part no.	Type
	Displacement encoder EGC...-M1/-M2	Motor controllers CMMP-AS and CMMT-AS	5.0	1599105	NEBM-M12G8-E-5-S1G9-V3
			10	1599106	NEBM-M12G8-E-10-S1G9-V3
			15	1599107	NEBM-M12G8-E-15-S1G9-V3
			X ¹⁾	1599108	NEBM-M12G8-E-...-S1G9-V3

1) Max. cable length 25 m.

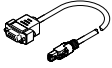
Ordering data – Adapter			
	Description	Part no.	Type
	Required in combination with the servo drive CMMT-AS as adapter between encoder cable NEBM-M12G8-...-V3 and interface X3 (position encoder 2)	8106112	NEFM-S1G9-K-0.5-R3G8

Festo core product range



Generally ready for shipping ex works in 24 hours

Generally ready for shipping ex works in 5 days

Festo - Your Partner in Automation



1 Festo Inc.
5300 Explorer Drive
Mississauga, ON L4W 5G4
Canada

Festo Customer Interaction Center
Tel: 1 877 463 3786
Fax: 1 877 393 3786
Email: customer.service.ca@festo.com



2 Festo Pneumatic
Av. Ceylán 3,
Col. Tequesquináhuac
54020 Tlalnepantla,
Estado de México

Multinational Contact Center
01 800 337 8669
ventas.mexico@festo.com



3 Festo Corporation
1377 Motor Parkway
Suite 310
Islandia, NY 11749

Festo Customer Interaction Center
1 800 993 3786
1 800 963 3786
customer.service.us@festo.com



4 Regional Service Center
7777 Columbia Road
Mason, OH 45040

Connect with us



www.festo.com/socialmedia



www.festo.com

Subject to change