

Standards-based cylinders DNC, ISO 15552

FESTO



Key features

At a glance



- Standards-based cylinders to ISO 15552 (corresponds to the withdrawn standards ISO 6431, DIN ISO 6431, VDMA 24562, NFE 49 003.1 and UNI 10290)
- The modern, consistent design saves up to 11% more space compared to ordinary standards-based cylinders, providing a significantly more compact system structure
- An extensive range of accessories enables the cylinder to be installed virtually anywhere
- The widest range of variants on the market offers the ideal cylinder DNC for any application

Cylinder with clamping units

DNC-KP



- Piston rod can be held or clamped in any position
- Piston rod can be held in position for long periods even with alternating loads, fluctuating operating pressure or leaks in the system

DNCKE

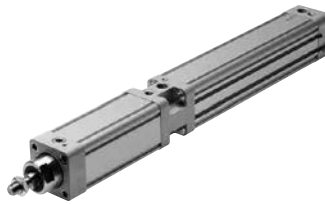

- Use in safety-related control systems observing the standards EN 954-1, EN 1050, EN 292 and EN 983
- Fail-safe
- Piston rod can be clamped in any position

Cylinder with end-position locking

DNC- ... -EL



- Mechanical locking when the end position is reached
- Locking is automatically released only when pressure is applied to the cylinder
- End-position locking at one or both ends

Cylinder/valve combination

DNC-V1 ... V6



- The cylinder/valve combination is assembled and fitted with tubing ready for connection
- Particularly suitable for decentralised use in large systems

Tandem cylinder

DNCT



- Series connection of 2 cylinders with the same piston diameter and stroke
- Twice the thrust and return force compared to a conventional cylinder

Longer service life with bellows kit DADB

















The bellows protects the piston rod, the seal and the bearing from the effects of a wide range of media, which has a positive impact on the service life of these components.

The bellows kit is a leak-free system. To prevent unwanted media from being drawn in, the supply and exhaust air for the kit must be ducted via a pressure compensation hole in the connection part [1].

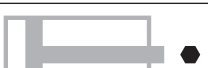
The kit protects the piston rod, seal and bearing against a wide variety of media, for example:

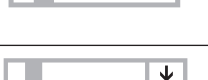
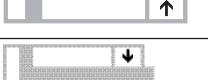
- Dust
- Chippings
- Oil
- Grease
- Fuel

Key features

Variants from the modular product system		
Symbol	Key features	Description
	S2 Through piston rod	The piston rod can be used for attachment at both ends of the cylinder
	S6 Heat-resistant seals	Temperature resistance up to max. 120°C
	S10 Constant motion (slow speed) at low piston speeds	<ul style="list-style-type: none"> • Break-away pressure: very low • Dynamic response: Suitable for very slow, constant and stick-slip-free movements Application example: Slow, constant feed motion
	S11 Low friction	<ul style="list-style-type: none"> • Break-away pressure: very low • Dynamic response: Especially suitable for slow movements with considerably reduced system friction • Application example: Slow applications where standstill is critical
	S20 Through, hollow piston rod	The piston rod can be used for attachment at both ends of the cylinder. The piston rod is hollow inside. This means it can be used to carry vacuum or compressed air
	K2 Extended male piston rod thread	–
	K3 Female piston rod thread	–
	K5 Custom piston rod thread	Metric standard thread to ISO
	K7 Piston rod with external hexagon	Special spanner flats
	K8 Extended piston rod	–
	K10 Smooth anodised aluminium piston rod	Ideal for use in welding environments: <ul style="list-style-type: none"> • Protection against welding spatter • Small working loads • Harder surface compared to steel • Long service life
	KP With clamping unit	Integrated clamping unit on the piston rod
	EL With end-position locking	Positive locking in the end position as a drop guard. If there is a drop in pressure, the cylinder is secured in its end position to prevent it from dropping
	Q Square piston rod	Protection against rotation. For correctly oriented feeding
	R3 High corrosion protection	All external cylinder surfaces comply with corrosion resistance class 3 to Festo standard 940070. The piston rod is made from corrosion- and acid-resistant steel
	R8 Dust protection with wiper seal	The cylinder has a hard-chrome-plated piston rod and a hard wiper seal, which protects against dry, dusty media

Product range overview

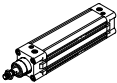
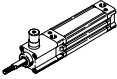
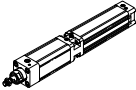
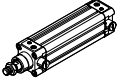
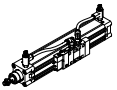
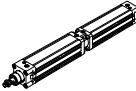
Function	Design	Type	Piston ø	Stroke	Position sensing	Protection against rotation	Through/hollow piston rod	Extended male piston rod thread	Female piston rod thread	Custom thread on the piston rod	
			[mm]	[mm]							A
Double-acting	Basic version										
		DNC	32, 40, 50, 63, 80, 100, 125	20, 25, 30, 40, 50, 60, 70, 80, 100, 125, 150, 160, 200, 250, 300, 320, 400, 500	10 ... 2000	■	■	■	■	■	■
	Standard hole pattern, with clamping unit										
		DNC-KP	32, 40, 50, 63, 80, 100, 125	–	10 ... 2000	■	■	■ S2	■	■	■
		DNCKE	40, 63, 100	–	10 ... 2000	■	–	–	–	–	–
	Standard hole pattern, with end-position locking										
		DNC-...-EL	32, 40, 50, 63, 80, 100	–	10 ... 2000	■	–	■ S2	■	■	■
	Standard hole pattern, cylinder/valve combination										
		DNC-V1 ... V6	32, 40, 50, 63, 80, 100	–	100 ... 2000	■	■	■	■	■	■
	Standard hole pattern, tandem cylinder										
	DNCT	32, 40, 50, 63, 80, 100, 125	–	2 ... 500 3 ... 500	■	–	–	–	–	–	

Product range overview

Type	Special spanner flats	Extended piston rod	Smooth anodised piston rod	Heat-resistant seals max. 120°C	Slow speed (constant motion)	Low friction	High corrosion protection	Dust protection	Cylinder/valve combination	→ Page/Internet
	K7	K8	K10	S6	S10	S11	R3	R8	V1 ... V6	
Basic version										
DNC	■	■	■	■	■	■	■	■	-	9
Standard hole pattern, with clamping unit										
DNC-KP	■	■	-	-	-	-	-	-	■	25
DNCKE	-	-	-	-	-	-	-	-	-	2
Standard hole pattern, with end-position locking										
DNC-...-EL	-	■	-	-	-	-	-	-	-	33
Standard hole pattern, cylinder/valve combination										
DNC-V1 ... V6	■	■	■	-	■	■	-	■	■	40
Standard hole pattern, tandem cylinder										
DNCT	-	-	-	■	-	-	-	-	-	2

Peripherals overview

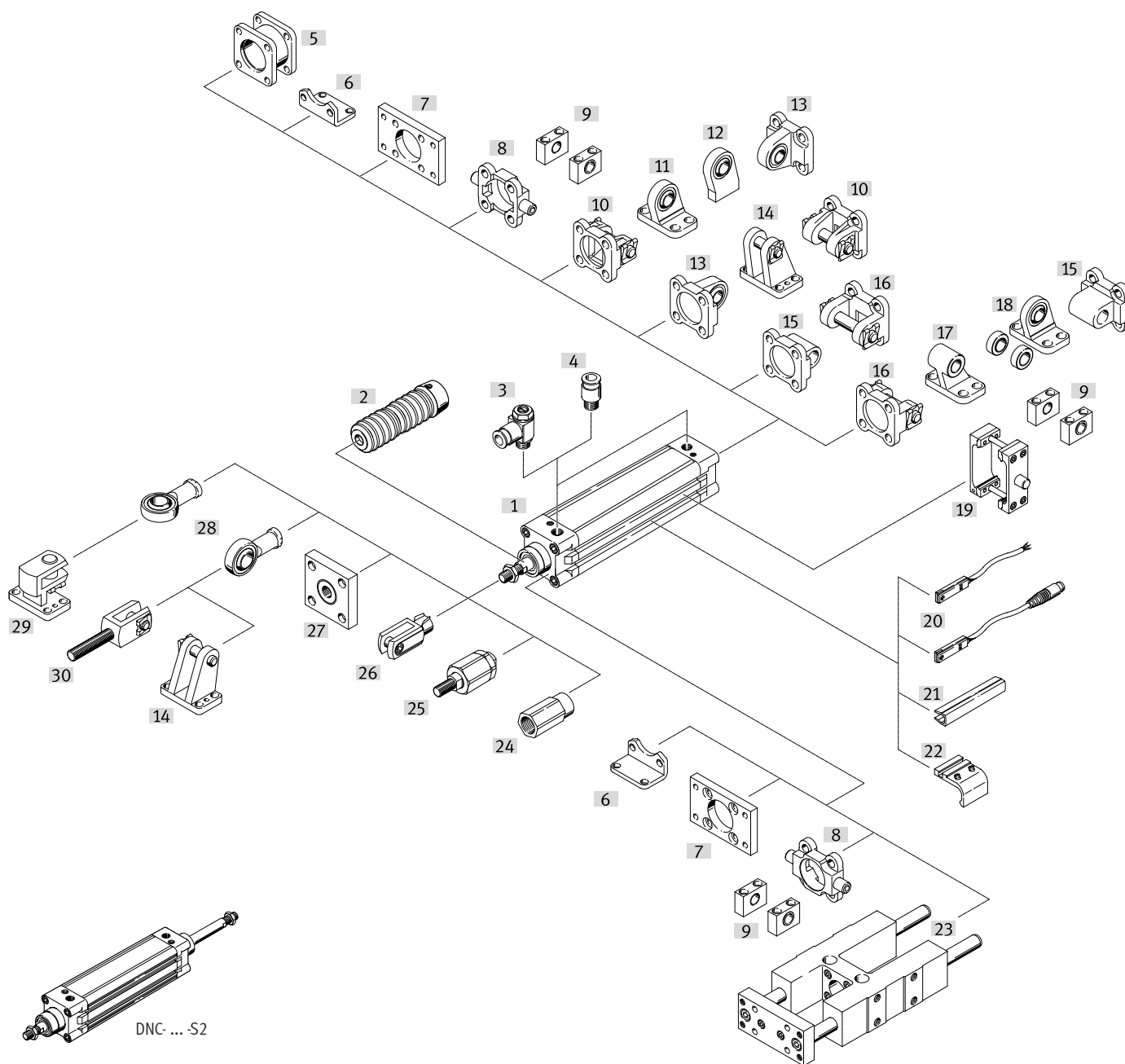

Mounting components and accessories

	Description	DNC				→ Page/ Internet
		Basic version	KP	EL	V1 ... V6	
[1]	Standards-based cylinder DNC					
[2]	Bellows kit DADB	■	-	■	■	61
[3]	One-way flow control valve GRLA	■	■	■	■	67
[4]	Push-in fitting QS	■	■	■	■	qs

Peripherals overview

Mounting components and accessories		Description	DNC				→ Page/ Internet
			Basic version	KP	EL	V1 ... V6	
[5]	Multi-position kit DPNC	For connecting two cylinders with the same piston diameter to form a multi-position cylinder	■ ¹⁾	■	■	■ ¹⁾	49
[6]	Foot mounting HNC/CRHNC	For bearing or end caps	■	■	■	■	50
[7]	Flange mounting FNC/CRFNG	<ul style="list-style-type: none"> For bearing or end caps Cannot be used on the bearing cap in combination with bellows kit DADB 	■	■	■	■	51
[8]	Trunnion flange ZNC/CRZNG	<ul style="list-style-type: none"> For bearing or end caps Cannot be used on the bearing cap in combination with bellows kit DADB 	■	■	■	■	52
[9]	Trunnion support LNZG/CRLNZG	–	■	■	■	■	54
[10]	Swivel flange SNC	For end caps	■ ¹⁾	■ ¹⁾	■	■ ¹⁾	55
[11]	Clevis foot LSNG	With spherical bearing	■ ¹⁾	■ ¹⁾	■	■ ¹⁾	59
[12]	Clevis foot LSNSG	Weld-on, with spherical bearing	■ ¹⁾	■ ¹⁾	■	■ ¹⁾	59
[13]	Swivel flange SNCS/CRSNCS/SNCS-...-R3	With spherical bearing for end caps	■ ¹⁾	■ ¹⁾	■	■ ¹⁾	57
[14]	Clevis foot LBG/LBG-...-R3	–	■ ¹⁾	■	■	■ ¹⁾	59
[15]	Swivel flange SNCL	For end caps	■ ¹⁾	■ ¹⁾	■	■ ¹⁾	58
[16]	Swivel flange SNCB/SNCB-...-R3	For end caps	■ ¹⁾	■ ¹⁾	■	■ ¹⁾	56
[17]	Clevis foot LNG/CRLNG	–	■ ¹⁾	■ ¹⁾	■	■ ¹⁾	59
[18]	Clevis foot LSN	With spherical bearing	■ ¹⁾	■ ¹⁾	■	■ ¹⁾	59
[19]	Trunnion flange kit DAMT	For mounting anywhere along the cylinder profile barrel	■	■	■	■	53
[20]	Proximity switch SME/SMT-8	Can be integrated in the cylinder profile barrel	■	■	■	■	66
[21]	Slot cover ABP-5-S	For protecting the sensor cables and the sensor slots from contamination	■	■	■	■	66
[22]	Mounting kit SMB-8-FENG	For attaching proximity switch SMT-8 to cylinders in combination with guide unit FENG	■ ²⁾	■ from Ø 50	■	–	65
[23]	Guide unit FENG	For protecting standards-based cylinders against rotation at high torques	■	■	–	–	65
[24]	Adapter AD	For mounting a suction cup on a hollow piston rod	■	–	–	■	60
[25]	Self-aligning rod coupler FK/CRFK	To compensate for radial and angular deviations	■	■	■	■	60
[26]	Rod clevis SG/CRSG	Permits a swivelling movement of the cylinder in one plane	■	■	■	■	60
[27]	Coupling piece KSG	To compensate for radial deviations	■	■	■	■	60
	Coupling piece KSZ	For cylinders with a non-rotating piston rod to compensate for radial deviations	■	■	■	■	60
[28]	Rod eye SGS/CRSGS	With spherical bearing	■	■	■	■	60
[29]	Right-angle clevis foot LQG	–	■	■	■	■	59
[30]	Rod clevis SGA	With male thread	■	■	■	■	60

1) Not with variant S2 or S20

2) For piston Ø 32, 40 mm only with variant R3

Type codes

001	Series	
DNC	Standards-based cylinder, double-acting, based on ISO 15552	
002	Piston diameter [mm]	
32	32	
40	40	
50	50	
63	63	
80	80	
100	100	
125	125	
003	Stroke [mm]	
...	2 ... 2000	
004	Cushioning	
P	Elastic cushioning rings/plates on both sides	
PPV	Pneumatic cushioning, adjustable at both ends	
005	Position sensing	
	None	
A	For proximity sensor	
006	Protection against rotation	
	None	
Q	With protection against rotation	
007	Piston rod type	
S2	Through piston rod	
S20	Through, hollow piston rod	
008	Piston rod thread type	
	Male thread	
K3	Female thread	

009	Custom thread	
	Standard piston rod thread	
"M10"K5	M10	
"M12"K5	M12	
"M16"K5	M16	
"M20"K5	M20	
"M27"K5	M27	
010	Special spanner flats	
K7	Piston rod with external hexagon	
011	Piston rod extension	
	None	
...K8	1 ... 500 mm	
012	Improved running performance	
	None	
K10	Smooth aluminium anodised coated piston rod	
013	Temperature resistance	
S6	Heat-resistant seals max. 120 °C	
014	Constant motion	
	None	
S10	Slow speed (constant motion at low piston speeds)	
015	Running characteristic	
S11	Low friction	
	None	
016	Corrosion protection	
	Standard	
R3	High corrosion protection	
017	Scraper	
R8	Dust protection	
	Standard	

 - Note

The standards-based cylinder DNC can be ordered either using a fixed part number and order reference or using the modular product system.

The type codes listed above represent the standards-based cylinders DNC with fixed part number and order reference only.

Variants can only be ordered using the modular product system.

Data sheet

Function

DNC...

Without position sensing

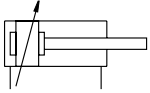
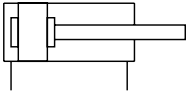

DNC...-A...

With position sensing

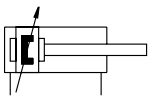
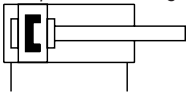

⌀ - Diameter
32 ... 125 mm

— - Stroke length
10 ... 2000 mm

 www.festo.com

Sets of wearing parts
→ Page 24

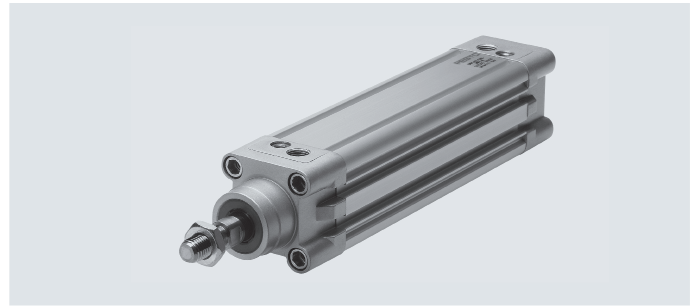

- Standards-based cylinders to ISO 15552 (corresponds to the withdrawn standards ISO 6431, DIN ISO 6431, VDMA 24562, NFE 49003.1 and UNI 10290)



General technical data

Piston Ø	32	40	50	63	80	100	125
Pneumatic connection	G1/8	G1/4	G1/4	G3/8	G3/8	G1/2	G1/2
Piston rod thread	M10x1.25	M12x1.25	M16x1.5	M16x1.5	M20x1.5	M20x1.5	M27x2
	K3 M6	M8	M10	M10	M12	M12	M16
	K5 M10	M12	M16	M16	M20	M20	M27
Design	Piston						
	Piston rod						
	Profile barrel						
Max. torsional backlash of piston rod [°]	Q ±0.65	±0.6	±0.45	±0.45	±0.45	±0.45	—
Cushioning	Elastic cushioning rings/pads at both ends						
	Pneumatic cushioning, adjustable at both ends						
Cushioning length PPV [mm]	20	20	22	22	32	32	42
Position sensing	Via proximity switch						
Type of mounting	With female thread						
	Via accessories						
Mounting position	Any						

† - Note: This product conforms to ISO 1179-1 and ISO 228-1.

Data sheet

Operating and environmental conditions		32	40	50	63	80	100	125
Piston ø								
Operating medium		Compressed air to ISO 8573-1:2010 [7:4:4]						
Note on operating/pilot medium		Lubricated operation possible (in which case lubricated operation will always be required)						
Operating pressure [bar]		0.6 ... 12						0.6 ... 10
Operating pressure [bar]	Q	1 ... 12						-
	Q-S6	1 ... 8						-
	R8	1.5 ... 12						1.5 ... 10
	S11	After 10 strokes						
			0.16 ... 12	0.1 ... 12	0.06 ... 12	0.06 ... 10		
After 24 h								
		0.3 ... 12	0.2 ... 12	0.1 ... 12	0.1 ... 10			
Ambient temperature ¹⁾ [°C]		-20 ... +80						
Corrosion resistance class CRC ²⁾		2						
		R3						
ATEX		Selected types → www.festo.com						
CE marking (see declaration of conformity)		To EU Explosion Protection Directive (ATEX)						
UKCA marking (see declaration of conformity)		To UK EX instructions						

1) Note operating range of proximity switches

2) Corrosion resistance class CRC 2 to Festo standard FN 940070

Moderate corrosion stress. Indoor applications in which condensation can occur. External visible parts with primarily decorative surface requirements which are in direct contact with a normal industrial environment.

Corrosion resistance class CRC 3 to Festo standard FN 940070

High corrosion stress. Outdoor exposure under moderate corrosive conditions. Externally visible parts with primarily functional surface requirements which are in direct contact with a normal industrial environment.

Forces [N] and impact energy [J]		32	40	50	63	80	100	125
Piston ø								
Theoretical force at 6 bar, advancing		483	754	1178	1870	3016	4712	7363
	S2/S20	415	633	990	1682	2721	4418	6881
Theoretical force at 6 bar, retracting		415	633	990	1682	2721	4418	6881
	S2/S20	415	633	990	1682	2721	4418	6881
Max. impact energy at the end positions ¹⁾		0.1	0.2	0.2	0.5	0.9	1.2	5

1) With variant K10 and S20, the permissible impact energy is reduced by approx. 10%

Permissible impact velocity:

$$v = \sqrt{\frac{2 \cdot E}{m_1 + m_2}}$$

V Permissible impact velocity

E Max. impact energy

m1 Moving mass (drive)

m2 Moving payload

Maximum permissible mass:

$$m_2 = \frac{2 \cdot E}{v^2} - m_1$$



Note

These specifications represent the maximum values that can be achieved. The maximum permissible impact energy must be observed.

Data sheet

Lateral force F_q as a function of stroke length l

Basic version

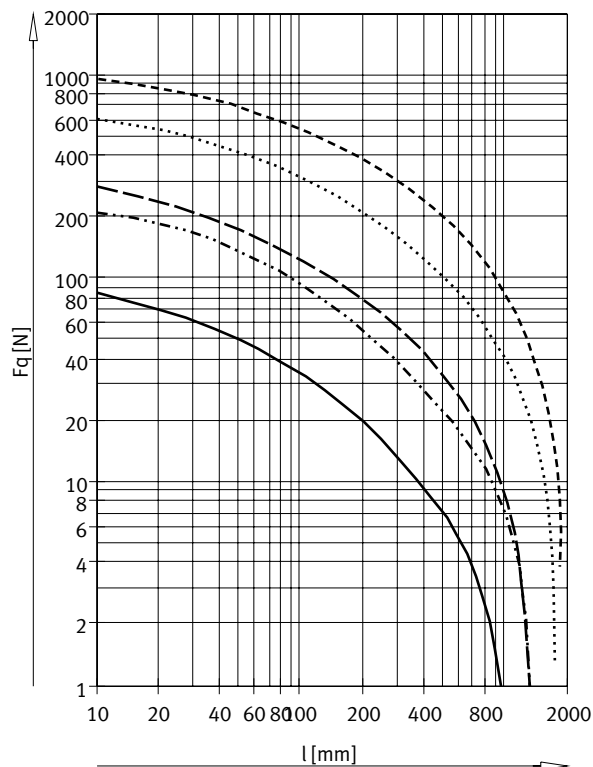

- ø 32
- ⋯ ø 40
- - - ø 50/63
- · - · ø 80/100
- - - - ø 125

Data sheet

Max. transverse force F_q as a function of stroke length l and lever arm s

Q – Square piston rod

$\varnothing 32$

$\varnothing 40$

Max. torque = 800 Nmm/max. stroke = 300 mm

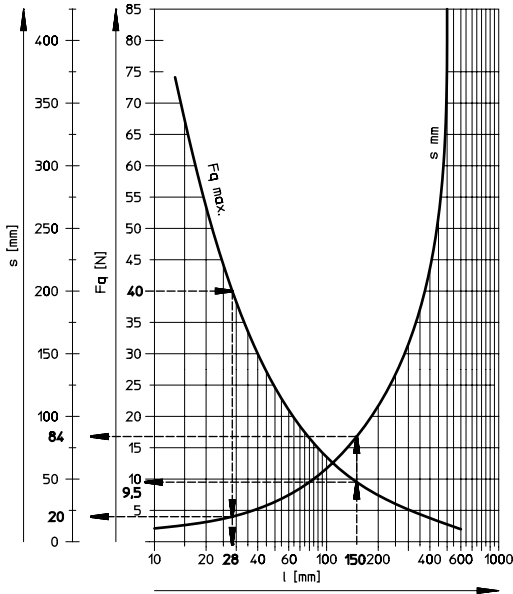

Max. torque = 1100 Nmm/max. stroke = 400 mm

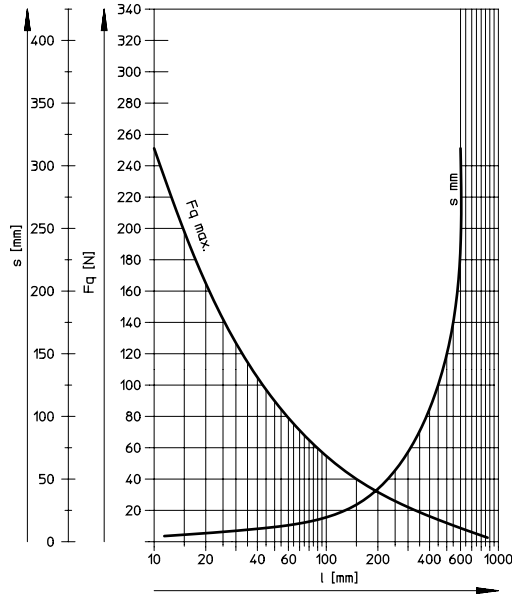

$\varnothing 50/63$

Max. torque = 1500 Nmm/max. stroke = 500 mm

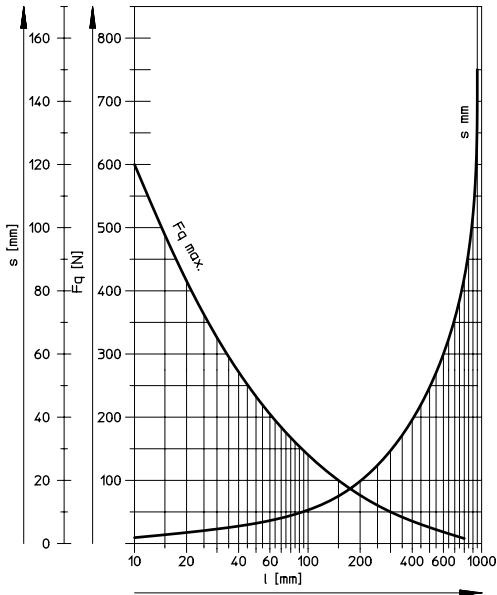

$\varnothing 80/100$

Max. torque = 3000 Nmm/max. stroke = 600 mm

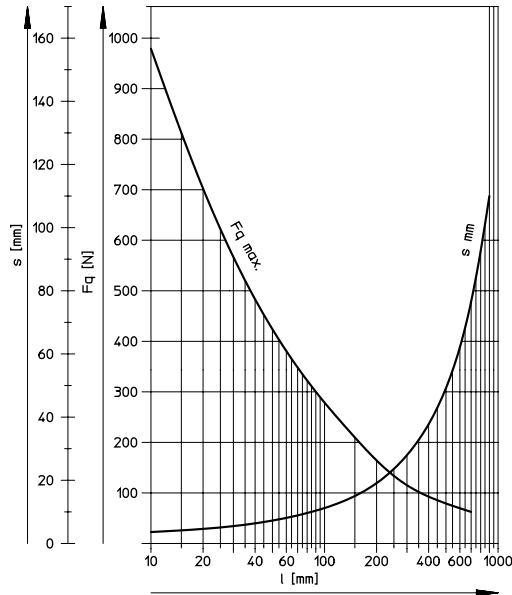

Examples for piston diameter 32 mm

Example 1:

Stroke length $l = 150$ mm

Result: permissible

Lateral force $F_q = 9.5$ N

Lever arm $s = 84$ mm

Example 2:

Lateral force $F_q = 40^\circ$ N

Result: permissible

Stroke length $l = 28$ mm

Lever arm $s = 20$ mm

Example 3:

Stroke length $l = 150$ mm

Lever arm $s = 100$ mm

$$F_q = \text{max. torque} / \text{lever arm} = 800 \text{ Nmm} / 100 \text{ mm}$$

Result: permissible

$$F_q = 8 \text{ N} < F_{q_{\text{max}}} = 9.5 \text{ N}$$

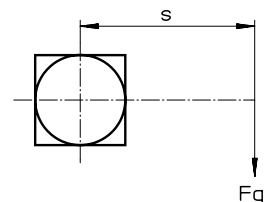
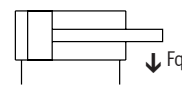

Data sheet

Weight [g]							
Piston ø	32	40	50	63	80	100	125
Basic version							
Product weight with 0 mm stroke	517	800	1260	1709	2790	4653	6771
Additional weight per 10 mm stroke	30	45	64	73	106	115	168
Moving mass with 0 mm stroke	162	307	538	663	1131	1544	2809
Add. moving mass per 10 mm stroke	9	16	25	25	38	38	63
Q – Square piston rod							
Product weight with 0 mm stroke	504	738	1187	1632	2652	4508	–
Additional weight per 10 mm stroke	29	41	60	68	99	108	–
Moving mass with 0 mm stroke	149	244	465	587	994	1399	–
Add. moving mass per 10 mm stroke	8	11	20	20	31	31	–
S2 – Through piston rod							
Product weight with 0 mm stroke	576	895	1 390	1917	3114	5297	7529
Additional weight per 10 mm stroke	39	61	89	98	144	153	231
Moving mass with 0 mm stroke	170	330	560	711	1200	1660	2925
Add. moving mass per 10 mm stroke	18	32	50	50	76	76	126
K10 – Smooth anodised piston rod							
Product weight with 0 mm stroke	443	655	1001	1437	2302	4138	5719
Additional weight per 10 mm stroke	24	35	47	57	81	90	127
Moving mass with 0 mm stroke	88	162	279	391	643	1029	1757
Add. moving mass per 10 mm stroke	3	6	8	9	13	13	22
S2-K10 – Through, smooth anodised piston rod							
Product weight with 0 mm stroke	514	766	1181	1676	2701	4821	6674
Additional weight per 10 mm stroke	27	40	56	65	94	103	148
Moving mass with 0 mm stroke	108	201	351	470	787	1184	2070
Add. moving mass per 10 mm stroke	6	11	17	17	26	26	43

Data sheet

Materials

Sectional view

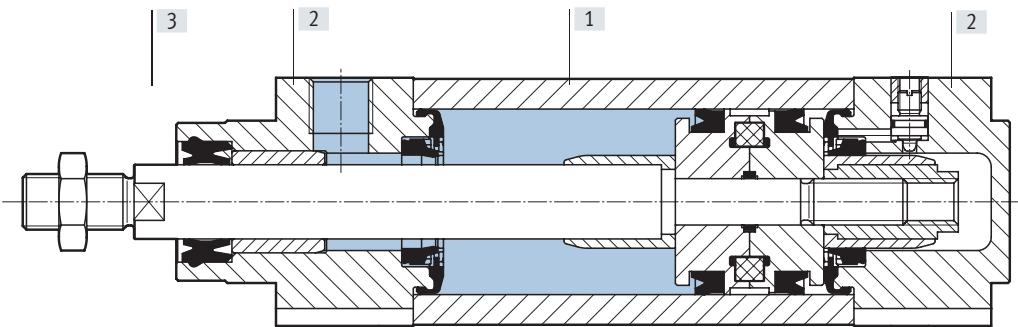

Standards-based cylinder	Basic version	K10	R3
[1] Profile barrel	Smooth-anodised wrought aluminium alloy		
[2] Bearing and end caps	Die-cast aluminium		
[3] Piston rod	High-alloy steel	Anodised wrought aluminium alloy	High-alloy stainless steel
- Seals	Polyurethane, nitrile rubber		
Note on materials	RoHS-compliant		

Standards-based cylinder	R8	S6	S10	S11
[1] Profile barrel	Smooth-anodised wrought aluminium alloy			
[2] Bearing and end caps	Die-cast aluminium			
[3] Piston rod	Hard-chrome-plated tempered steel	High-alloy steel		
- Seals	Polyurethane, nitrile rubber	Fluoro rubber		
Note on materials	RoHS-compliant			
	-		Contains paint-wetting impairment substances	
PWIS conformity	VDMA24364-B1/B2-L		VDMA24364 zone III	

Data sheet

Dimensions – Basic version

Download CAD data → www.festo.com

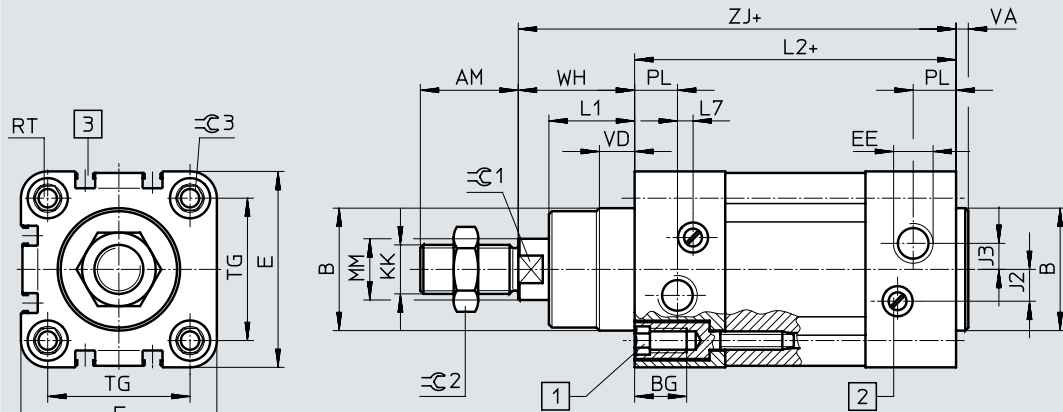

- [1] For mounting accessories:
 ∅ 32 ... 100: Socket head screw with female thread
 ∅ 125: Thread in cover
 - [2] Adjusting screw for adjustable end-position cushioning
 - [3] Sensor slot for proximity switch SME/SMT-8
- + = plus stroke length

∅	AM	B ∅ d11	BG	E	EE	J2	J3	KK	L1	L2
32	22	30	16	45	G1/8	6	5.2	M10x1.25	18	94
40	24	35	16	54	G1/4	8	6	M12x1.25	21.5	105
50	32	40	17	64	G1/4	10.4	8.5	M16x1.5	28	106
63	32	45	17	75	G3/8	12.4	10	M16x1.5	28.5	121
80	40	45	17	93	G3/8	12.5	8	M20x1.5	34.7	128
100	40	55	17	110	G1/2	12	10	M20x1.5	38.2	138
125	54	60	22	134	G1/2	13	8	M27x2	46	160

∅	L7	MM ∅	PL	RT	TG	VA	VD	WH	ZJ	∅C1	∅C2	∅C3
32	3.3	12	15.6	M6	32.5	4	10	26	120	10	16	6
40	3.6	16	14	M6	38	4	10.5	30	135	13	18	6
50	5.1	20	14	M8	46.5	4	11.5	37	143	17	24	8
63	6.6	20	17	M8	56.5	4	15	37	158	17	24	8
80	10.5	25	16.4	M10	72	4	15.7	46	174	22	30	6
100	8	25	18.8	M10	89	4	19.2	51	189	22	30	6
125	14	32	18	M12	110	6	20.5	65	225	27	36	8

Note: This product conforms to ISO 1179-1 and ISO 228-1.

Data sheet

Dimensions – Variants

Download CAD data → www.festo.com

Q – Square piston rod

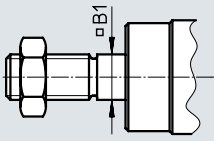

S2 – Through piston rod

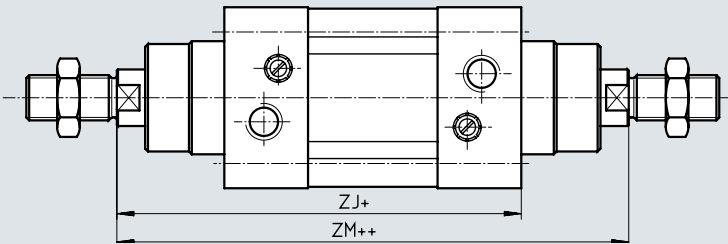

+ = plus stroke length
++ = plus 2x stroke length

S20 – Through, hollow piston rod

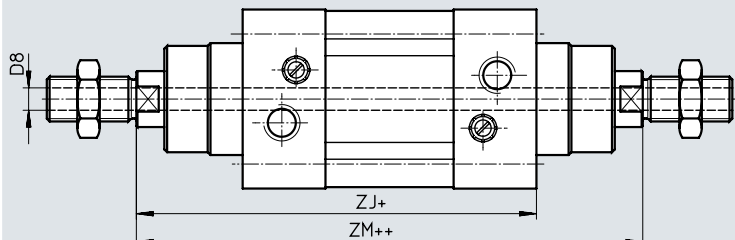

+ = plus stroke length
++ = plus 2x stroke length

\varnothing [mm]	B1 □	D8 \varnothing	ZJ	ZM
32	10	4.5	120	148
40	12	5.5	135	167
50	16	8 ¹⁾	143	183
63	16	8	158	199
80	20	11.7	174	222
100	20	11.7	189	240
125	–	13	225	291

1) Internal narrowing to 5.5 mm diameter

Data sheet

Dimensions – Variants

Download CAD data → www.festo.com

K2 – Extended male piston rod thread

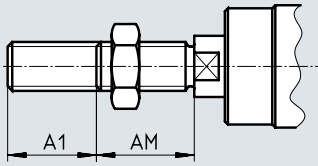

K3 – Female piston rod thread

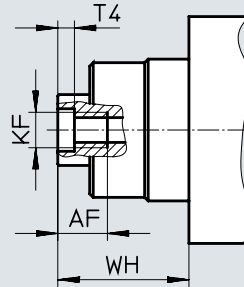

K5 – Custom piston rod thread

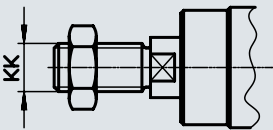

K7 – Piston rod with external hexagon

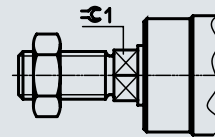

K8 – Extended piston rod

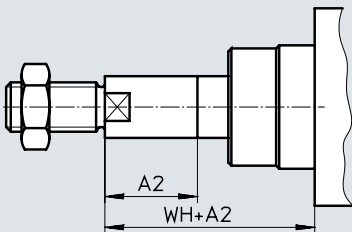

Note

In combination with variant S2/S20, the piston rod is extended at one end.

In combination with variant Q, the square piston rod is extended

ø [mm]	A1 max.	A2 max.	AF	AM	KF	KK		T4	WH	=C1
						Basic thread	Custom thread ¹⁾			
32	35	500	12	22	M6	M10x1.25	M10	2.6	26	10
40	35	500	12	24	M8	M12x1.25	M12	3.3	30	13
50	70	500	16	32	M10	M16x1.5	M16	4.7	37	17
63	70	500	16	32	M10	M16x1.5	M16	4.7	37	17
80	70	500	20	40	M12	M20x1.5	M20	6.1	46	22
100	70	500	20	40	M12	M20x1.5	M20	6.1	51	22
125	70	500	32	54	M16	M27x2	M27	8	65	27

1) The custom threads are only available as male threads. The mounting nut on the piston rod thread is included in the scope of delivery

Data sheet

Ordering data – Without position sensing							
Piston ø [mm]	Stroke [mm]	Part no.	Type ¹⁾	Piston ø [mm]	Stroke [mm]	Part no.	Type ¹⁾
32	25	163319	DNC-32-25-PPV	40	25	163351	DNC-40-25-PPV
	40	163320	DNC-32-40-PPV		40	163352	DNC-40-40-PPV
	50	163321	DNC-32-50-PPV		50	163353	DNC-40-50-PPV
	80	163322	DNC-32-80-PPV		80	163354	DNC-40-80-PPV
	100	163323	DNC-32-100-PPV		100	163355	DNC-40-100-PPV
	125	163324	DNC-32-125-PPV		125	163356	DNC-40-125-PPV
	160	163325	DNC-32-160-PPV		160	163357	DNC-40-160-PPV
	200	163326	DNC-32-200-PPV		200	163358	DNC-40-200-PPV
	250	163327	DNC-32-250-PPV		250	163359	DNC-40-250-PPV
	320	163328	DNC-32-320-PPV		320	163360	DNC-40-320-PPV
	400	163329	DNC-32-400-PPV		400	163361	DNC-40-400-PPV
500	163330	DNC-32-500-PPV	500	163362	DNC-40-500-PPV		
50	25	163383	DNC-50-25-PPV	63	25	163415	DNC-63-25-PPV
	40	163384	DNC-50-40-PPV		40	163416	DNC-63-40-PPV
	50	163385	DNC-50-50-PPV		50	163417	DNC-63-50-PPV
	80	163386	DNC-50-80-PPV		80	163418	DNC-63-80-PPV
	100	163387	DNC-50-100-PPV		100	163419	DNC-63-100-PPV
	125	163388	DNC-50-125-PPV		125	163420	DNC-63-125-PPV
	160	163389	DNC-50-160-PPV		160	163421	DNC-63-160-PPV
	200	163390	DNC-50-200-PPV		200	163422	DNC-63-200-PPV
	250	163391	DNC-50-250-PPV		250	163423	DNC-63-250-PPV
	320	163392	DNC-50-320-PPV		320	163424	DNC-63-320-PPV
	400	163393	DNC-50-400-PPV		400	163425	DNC-63-400-PPV
500	163394	DNC-50-500-PPV	500	163426	DNC-63-500-PPV		
80	25	163447	DNC-80-25-PPV	100	25	163479	DNC-100-25-PPV
	40	163448	DNC-80-40-PPV		40	163480	DNC-100-40-PPV
	50	163449	DNC-80-50-PPV		50	163481	DNC-100-50-PPV
	80	163450	DNC-80-80-PPV		80	163482	DNC-100-80-PPV
	100	163451	DNC-80-100-PPV		100	163483	DNC-100-100-PPV
	125	163452	DNC-80-125-PPV		125	163484	DNC-100-125-PPV
	160	163453	DNC-80-160-PPV		160	163485	DNC-100-160-PPV
	200	163454	DNC-80-200-PPV		200	163486	DNC-100-200-PPV
	250	163455	DNC-80-250-PPV		250	163487	DNC-100-250-PPV
	320	163456	DNC-80-320-PPV		320	163488	DNC-100-320-PPV
	400	163457	DNC-80-400-PPV		400	163489	DNC-100-400-PPV
500	163458	DNC-80-500-PPV	500	163490	DNC-100-500-PPV		
125	25	163511	DNC-125-25-PPV				
	40	163512	DNC-125-40-PPV				
	50	163513	DNC-125-50-PPV				
	80	163514	DNC-125-80-PPV				
	100	163515	DNC-125-100-PPV				
	125	163516	DNC-125-125-PPV				
	160	163517	DNC-125-160-PPV				
	200	163518	DNC-125-200-PPV				
	250	163519	DNC-125-250-PPV				
	320	163520	DNC-125-320-PPV				
	400	163521	DNC-125-400-PPV				
500	163522	DNC-125-500-PPV					

1) The mounting nut on the piston rod thread is included in the scope of delivery

Data sheet

Ordering data – With position sensing							
Piston ø [mm]	Stroke [mm]	Part no.	Type ¹⁾	Piston ø [mm]	Stroke [mm]	Part no.	Type ¹⁾
32	20	1922617	DNC-32-20-PPV-A	40	20	1922623	DNC-40-20-PPV-A
	25	163305	DNC-32-25-PPV-A		25	163337	DNC-40-25-PPV-A
	30	1922618	DNC-32-30-PPV-A		30	1922624	DNC-40-30-PPV-A
	40	163306	DNC-32-40-PPV-A		40	163338	DNC-40-40-PPV-A
	50	163307	DNC-32-50-PPV-A		50	163339	DNC-40-50-PPV-A
	60	1922619	DNC-32-60-PPV-A		60	1922625	DNC-40-60-PPV-A
	70	1922620	DNC-32-70-PPV-A		70	1922626	DNC-40-70-PPV-A
	80	163308	DNC-32-80-PPV-A		80	163340	DNC-40-80-PPV-A
	100	163309	DNC-32-100-PPV-A		100	163341	DNC-40-100-PPV-A
	125	163310	DNC-32-125-PPV-A		125	163342	DNC-40-125-PPV-A
	150	1922621	DNC-32-150-PPV-A		150	1922627	DNC-40-150-PPV-A
	160	163311	DNC-32-160-PPV-A		160	163343	DNC-40-160-PPV-A
	200	163312	DNC-32-200-PPV-A		200	163344	DNC-40-200-PPV-A
	250	163313	DNC-32-250-PPV-A		250	163345	DNC-40-250-PPV-A
	300	1922622	DNC-32-300-PPV-A		300	1922628	DNC-40-300-PPV-A
	320	163314	DNC-32-320-PPV-A		320	163346	DNC-40-320-PPV-A
400	163315	DNC-32-400-PPV-A	400	163347	DNC-40-400-PPV-A		
500	163316	DNC-32-500-PPV-A	500	163348	DNC-40-500-PPV-A		
50	20	1922629	DNC-50-20-PPV-A	63	20	1922635	DNC-63-20-PPV-A
	25	163369	DNC-50-25-PPV-A		25	163401	DNC-63-25-PPV-A
	30	1922630	DNC-50-30-PPV-A		30	1922636	DNC-63-30-PPV-A
	40	163370	DNC-50-40-PPV-A		40	163402	DNC-63-40-PPV-A
	50	163371	DNC-50-50-PPV-A		50	163403	DNC-63-50-PPV-A
	60	1922631	DNC-50-60-PPV-A		60	1922637	DNC-63-60-PPV-A
	70	1922632	DNC-50-70-PPV-A		70	1922638	DNC-63-70-PPV-A
	80	163372	DNC-50-80-PPV-A		80	163404	DNC-63-80-PPV-A
	100	163373	DNC-50-100-PPV-A		100	163405	DNC-63-100-PPV-A
	125	163374	DNC-50-125-PPV-A		125	163406	DNC-63-125-PPV-A
	150	1922633	DNC-50-150-PPV-A		150	1922639	DNC-63-150-PPV-A
	160	163375	DNC-50-160-PPV-A		160	163407	DNC-63-160-PPV-A
	200	163376	DNC-50-200-PPV-A		200	163408	DNC-63-200-PPV-A
	250	163377	DNC-50-250-PPV-A		250	163409	DNC-63-250-PPV-A
	300	1922634	DNC-50-300-PPV-A		300	1922640	DNC-63-300-PPV-A
	320	163378	DNC-50-320-PPV-A		320	163410	DNC-63-320-PPV-A
400	163379	DNC-50-400-PPV-A	400	163411	DNC-63-400-PPV-A		
500	163380	DNC-50-500-PPV-A	500	163412	DNC-63-500-PPV-A		

1) The mounting nut on the piston rod thread is included in the scope of delivery

Data sheet

Ordering data – With position sensing			
Piston ø [mm]	Stroke [mm]	Part no.	Type ¹⁾
80	20	1922641	DNC-80-20-PPV-A
	25	163433	DNC-80-25-PPV-A
	30	1922642	DNC-80-30-PPV-A
	40	163434	DNC-80-40-PPV-A
	50	163435	DNC-80-50-PPV-A
	60	1922643	DNC-80-60-PPV-A
	70	1922644	DNC-80-70-PPV-A
	80	163436	DNC-80-80-PPV-A
	100	163437	DNC-80-100-PPV-A
	125	163438	DNC-80-125-PPV-A
	150	1922645	DNC-80-150-PPV-A
	160	163439	DNC-80-160-PPV-A
	200	163440	DNC-80-200-PPV-A
	250	163441	DNC-80-250-PPV-A
	300	1922646	DNC-80-300-PPV-A
	320	163442	DNC-80-320-PPV-A
400	163443	DNC-80-400-PPV-A	
500	163444	DNC-80-500-PPV-A	
100	25	163465	DNC-100-25-PPV-A
	40	163466	DNC-100-40-PPV-A
	50	163467	DNC-100-50-PPV-A
	80	163468	DNC-100-80-PPV-A
	100	163469	DNC-100-100-PPV-A
	125	163470	DNC-100-125-PPV-A
	160	163471	DNC-100-160-PPV-A
	200	163472	DNC-100-200-PPV-A
	250	163473	DNC-100-250-PPV-A
	320	163474	DNC-100-320-PPV-A
	400	163475	DNC-100-400-PPV-A
500	163476	DNC-100-500-PPV-A	
125	25	163497	DNC-125-25-PPV-A
	40	163498	DNC-125-40-PPV-A
	50	163499	DNC-125-50-PPV-A
	80	163500	DNC-125-80-PPV-A
	100	163501	DNC-125-100-PPV-A
	125	163502	DNC-125-125-PPV-A
	160	163503	DNC-125-160-PPV-A
	200	163504	DNC-125-200-PPV-A
	250	163505	DNC-125-250-PPV-A
	320	163506	DNC-125-320-PPV-A
	400	163507	DNC-125-400-PPV-A
500	163508	DNC-125-500-PPV-A	

1) The mounting nut on the piston rod thread is included in the scope of delivery

Data sheet

Ordering data – Variable stroke			
Piston Ø [mm]	Stroke [mm]	Without position sensing	
		Part no.	Type ¹⁾
32	10 ... 2000	163318	DNC-32-...-PPV
40	10 ... 2000	163350	DNC-40-...-PPV
50	10 ... 2000	163382	DNC-50-...-PPV
63	10 ... 2000	163414	DNC-63-...-PPV
80	10 ... 2000	163446	DNC-80-...-PPV
100	10 ... 2000	163478	DNC-100-...-PPV
125	10 ... 2000	163510	DNC-125-...-PPV

1) The mounting nut on the piston rod thread is included in the scope of delivery

Ordering data – Variable stroke			
Piston Ø [mm]	Stroke [mm]	With position sensing	
		Part no.	Type ¹⁾
32	10 ... 2000	163304	DNC-32-...-PPV-A
40	10 ... 2000	163336	DNC-40-...-PPV-A
50	10 ... 2000	163368	DNC-50-...-PPV-A
63	10 ... 2000	163400	DNC-63-...-PPV-A
80	10 ... 2000	163432	DNC-80-...-PPV-A
100	10 ... 2000	163464	DNC-100-...-PPV-A
125	10 ... 2000	163496	DNC-125-...-PPV-A

1) The mounting nut on the piston rod thread is included in the scope of delivery

Ordering data – Modular product system

Ordering table										
Size	32	40	50	63	80	100	125	Conditions	Code	Enter code
Module no.	163302	163334	163366	163398	163430	163462	163494			
Function	Standards-based cylinders, double-acting, based on ISO 15552								DNC	DNC
Piston ø [mm]	32	40	50	63	80	100	125		-...	
Stroke [mm]	10 ... 2000								-...	
Cushioning	Elastic cushioning rings/pads at both ends								-P	
	Pneumatic cushioning, adjustable at both ends							[15]	-PPV	
Position sensing	Via proximity switch								-A	
Protection against rotation	Square piston rod						-	[2]	-Q	
Piston rod type	Through piston rod							[3]	-S2	
	Through, hollow piston rod							[4]	-S20	
Extended male thread [mm]	Extended male piston rod thread									
	1 ... 35		1 ... 70					[5]	-...K2	
Female thread	Piston rod with female thread									
	(M6)	(M8)	(M10)	(M10)	(M12)	(M12)	(M16)	[6]	-K3	
Custom thread	Custom thread on the piston rod									
	M10	M12	M16	M16	M20	M20	M27	[7]	-...K5	

[15] PPV Not with S11 for piston diameter 125

[2] Q Max. stroke: 10 ... 1500 mm.
In combination with S2: square piston rod at bearing cap end only.
Not with S20, K7, K10, S10, S11, R8

[3] S2 In combination with K2: thread extension at both ends.
In combination with K3: female thread at both ends.
In combination with K5: custom thread at both ends.
In combination with K8: piston rod extension at bearing cap end only.
Not with K7, S10, S11

[4] S20 Max. stroke: 850 mm.
Not with K2, K3, K5, K8, K10, S6, S10, S11, R8

[5] K2 Not with K3, K10

[6] K3 With K5: on request.
Not with K7

[7] K5 Not with K10

Ordering data – Modular product system

Ordering table		32	40	50	63	80	100	125	Conditions	Code	Enter code
Special spanner flats	Piston rod with external hexagon								[8]	-K7	
Extended piston rod [mm]	Extended piston rod 1 ... 500									-...K8	
Improved running performance	Smooth anodised aluminium piston rod							-	[9]	-K10	
Temperature resistance	Heat-resistant seals max. 120°C								[10]	-S6	
Constant motion	Slow speed (constant motion at low piston speeds)							-	[12]	-S10	
Running characteristic	Low friction								[13]	-S11	
Corrosion protection	High corrosion protection								[14]	-R3	
Scraper	Dust protection									-R8	

[8] K7 Not with Q, S2, K10

[9] K10 Max. stroke: 1000 mm.

Not with S6, R3, R8

[10] S6 Not with S10, S11, R8

[12] S10 Max. stroke: 500 mm; additional strokes on request.

Not with S11, R3, R8

[13] S11 Max. stroke: 500 mm; additional strokes on request.

Not with R3, R8

[14] R3 Not with R8

Ordering data

Sets of wearing parts			Part no.	Type	Part no.	Type
Piston ø	Basic version				S6 – Heat-resistant seals up to max. 120°C	
32	369195	DNC-32-...-PPV-(A)	384214	DNC-32-...-PPV-(A)-S6		
40	369196	DNC-40-...-PPV-(A)	384215	DNC-40-...-PPV-(A)-S6		
50	369197	DNC-50-...-PPV-(A)	384216	DNC-50-...-PPV-(A)-S6		
63	369198	DNC-63-...-PPV-(A)	384217	DNC-63-...-PPV-(A)-S6		
80	369199	DNC-80-...-PPV-(A)	384218	DNC-80-...-PPV-(A)-S6		
100	369200	DNC-100-...-PPV-(A)	384219	DNC-100-...-PPV-(A)-S6		
125	369201	DNC-125-...-PPV-(A)	384220	DNC-125-...-PPV-(A)-S6		

Data sheet

Function

DNC-...-KP

Without position sensing

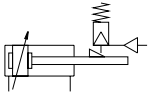
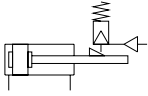

DNC-...-A-...-KP

With position sensing

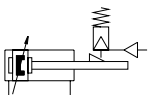
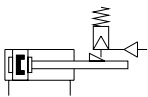



⌀ - Diameter
32 ... 125 mm

— - Stroke length
10 ... 2000 mm

 www.festo.com

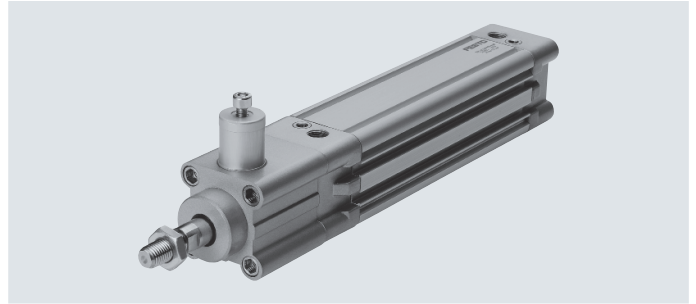
Sets of wearing parts
→ Page 32



 **Note**
If used in safety-relevant applications, additional measures are necessary, e.g. in Europe the standards listed in the EC Machinery Directive must be observed.
Without additional measures in accordance with legally specified minimum requirements, the product is not suitable as a safety-related component in control systems.

General technical data

Piston Ø		32	40	50	63	80	100	125
Pneumatic connection	Cylinder	G1/8	G1/4	G1/4	G3/8	G3/8	G1/2	G1/2
	KP	M5	G1/8	G1/8	G1/8	G1/8	G1/8	G1/8
Piston rod thread		M10x1.25	M12x1.25	M16x1.5	M16x1.5	M20x1.5	M20x1.5	M27x2
	K3	M6	M8	M10	M10	M12	M12	M16
	K5	M10	M12	M16	M16	M20	M20	M27
Axial backlash under load	[mm]	0.5		0.8				1.8
Design		Piston						
		Piston rod						
		Profile barrel						
		Clamping unit						
Cushioning		Elastic cushioning rings/pads at both ends						
		Pneumatic cushioning, adjustable at both ends						
Cushioning length PPV	[mm]	20	20	22	22	32	32	42
Position sensing		Via proximity switch						
Type of mounting		With female thread						
		Via accessories						
Mounting position		Any						
Type of clamping with effective direction		At both ends						

† Note: This product conforms to ISO 1179-1 and ISO 228-1.

Operating and environmental conditions

Operating medium		Compressed air to ISO 8573-1:2010 [7:4:4]
Note on operating/pilot medium		Lubricated operation possible (in which case lubricated operation will always be required)
Operating pressure [bar]		1.5 ... 10
	Q	1 ... 12
Min. release pressure [bar]		3
Ambient temperature ¹⁾ [°C]		-10 ... +80
Corrosion resistance class CRC ²⁾		2

1) Note operating range of proximity switches

2) Corrosion resistance class CRC 2 to Festo standard FN 940070

Moderate corrosion stress. Indoor applications in which condensation can occur. External visible parts with primarily decorative surface requirements which are in direct contact with a normal industrial environment.

Data sheet

Impact energy [J]							
Piston \varnothing	32	40	50	63	80	100	125
Max. impact energy at the end positions	0.1	0.2	0.2	0.5	0.9	1.2	5

Permissible impact velocity:

$$\sqrt{\frac{2 \cdot E}{m_1}}$$

V Permissible impact velocity

E Max. impact energy

m1 Moving mass (drive)

m2 Moving payload

Maximum permissible mass:

$$m_2 = \frac{2 \cdot E}{V^2} - m_1$$



Note

These specifications represent the maximum values that can be achieved. The maximum permissible impact energy must be observed.

Forces [N]							
Piston \varnothing	32	40	50	63	80	100	125
Theoretical force at 6 bar, advancing	483	754	1 178	1870	3016	4712	7363
S2	415	633	990	1682	2721	4418	6881
Theoretical force at 6 bar, retracting	415	633	990	1682	2721	4418	6881
S2	415	633	990	1682	2721	4418	6881
Static holding force	600	1000	1400	2000	5000	5000	7500



Note

The specified holding force refers to a static load. If this value is exceeded, slippage may occur. Dynamic forces occurring during operation must

not exceed the static holding force. The clamping unit is not backlash-free in the clamped condition if varying loads are applied to the piston rod.

Actuation:

The clamping unit may only be released if the forces at the piston have reached equilibrium. Otherwise, there is a risk of accidents due to sudden movement of the piston rod.

Blocking off the compressed air supply at both ends (e.g. with a 5/3-way valve) does not provide any safety.

Data sheet

Max. transverse force F_q as a function of stroke length l

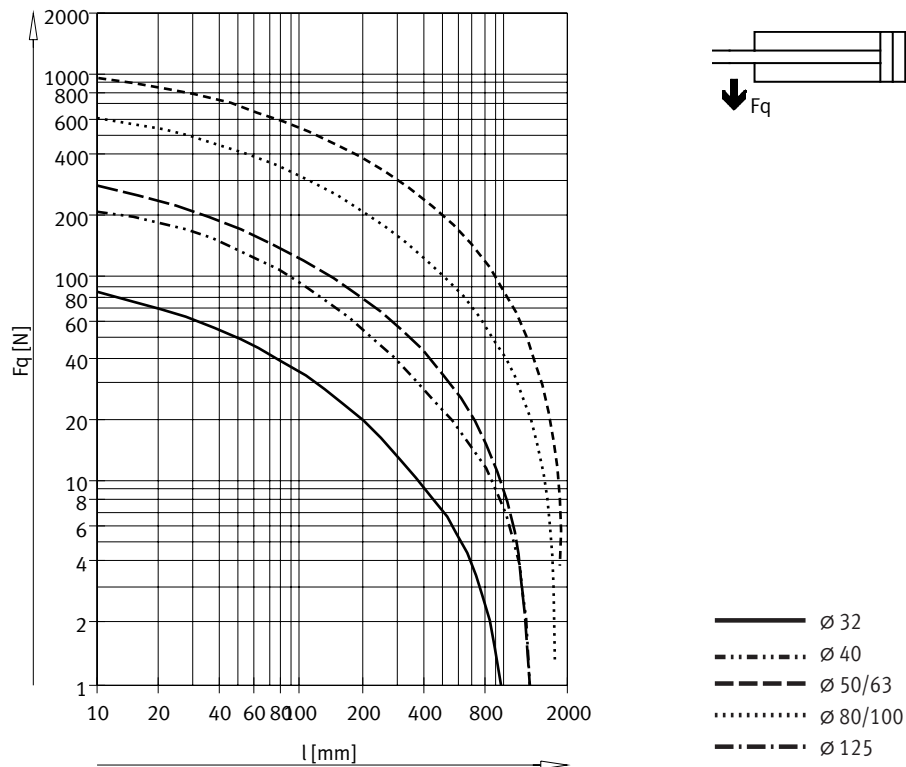

Materials

Sectional view

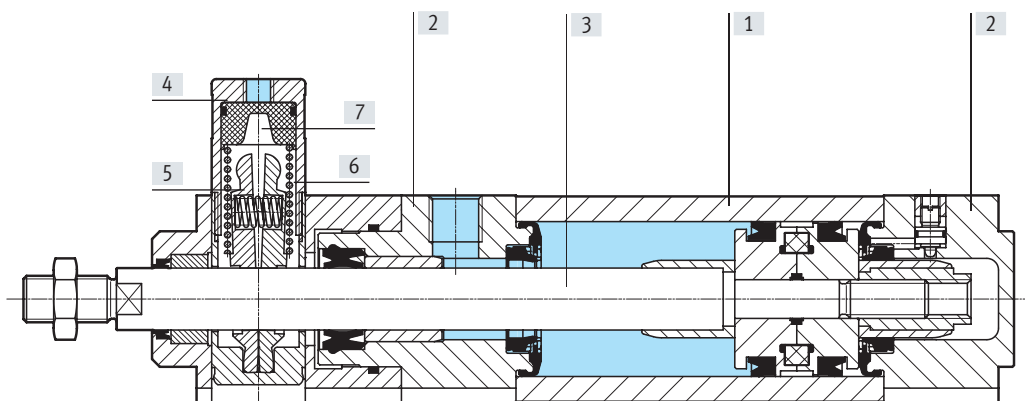

Standards-based cylinder

[1]	Profile barrel	Smooth-anodised wrought aluminium alloy
[2]	Bearing and end caps	Die-cast aluminium
[3]	Piston rod	High-alloy steel
[4]	Housing, clamping unit	Anodised wrought aluminium alloy
[5]	Clamping jaw	Brass
[6]	Spring	Spring steel
[7]	Piston	Polyacetal
-	Seals	Polyurethane, nitrile rubber
-	Note on materials	RoHS-compliant
-	PWIS conformity	VDMA24364-B1/B2-L

Data sheet

Dimensions – Basic version

Download CAD data → www.festo.com

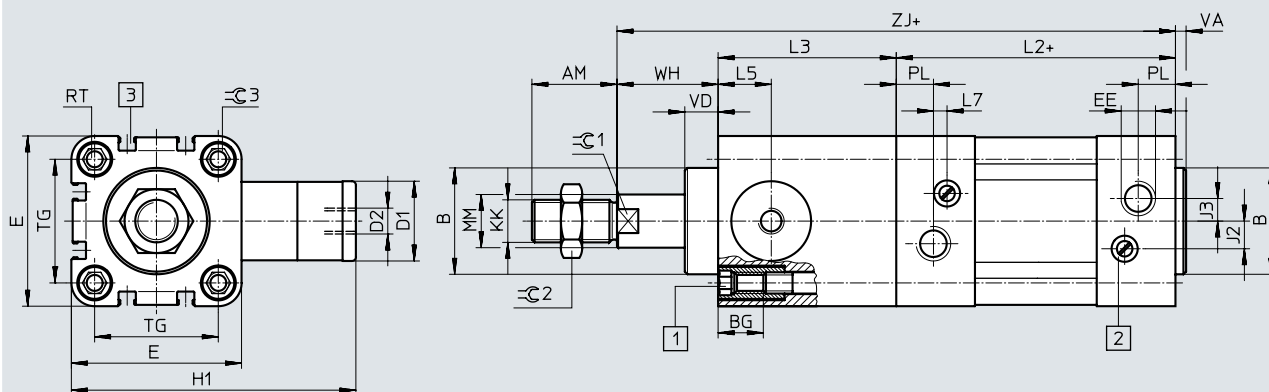

- [1] For mounting accessories:
 Ø 32 ... 100: Socket head screw with female thread
 Ø 125: Thread in cover
 - [2] Adjusting screw for adjustable end-position cushioning
 - [3] Sensor slot for proximity switch SME/SMT-8
- + = plus stroke length

∅ [mm]	AM	B ∅ d11	BG	D1 ∅ f9	D2	E	EE	H1	J2	J3	KK	L2	L3
32	22	30	16	20	M5	45	G1/8	67	6	5.2	M10x1.25	94	45
40	24	35	16	24	G1/8	54	G1/4	88	8	6	M12x1.25	105	53
50	32	40	17	30	G1/8	64	G1/4	107	10.4	8.5	M16x1.5	106	67
63	32	45	17	38	G1/8	75	G3/8	123	12.4	10	M16x1.5	121	76
80	40	45	17	48	G1/8	93	G3/8	165.5	12.5	8	M20x1.5	128	95
100	40	55	17	48	G1/8	110	G1/2	174	12	10	M20x1.5	138	98
125	54	60	22	65	G1/8	134	G1/2	207	13	8	M27x2	160	125

∅ [mm]	L5	L7	MM ∅	PL	RT	TG	VA	VD	WH	ZJ	∅C1	∅C2	∅C3
32	14	3.3	12	15.6	M6	32.5	4	11.5	26	165	10	16	6
40	16	3.6	16	14	M6	38	4	11.5	30	188	13	18	6
50	20	5.1	20	14	M8	46.5	4	11	37	210	17	24	8
63	24	6.6	20	17	M8	56.5	4	11	37	234	17	24	8
80	31.5	10.5	25	16.4	M10	72	4	12.5	46	269	22	30	6
100	31	8	25	18.8	M10	89	4	12	51	287	22	30	6
125	42	14	32	18	M12	110	6	27.5	65	350	27	36	8

Note: This product conforms to ISO 1179-1 and ISO 228-1.

Note
 The dimensions for the cylinder/
 valve combination are on
 → page 44

Data sheet

Dimensions – Variants

Download CAD data → www.festo.com

Q – Square piston rod

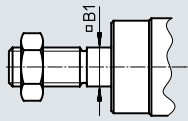

Note

Clamping unit and variant Q only in combination with S2

S2 – Through piston rod

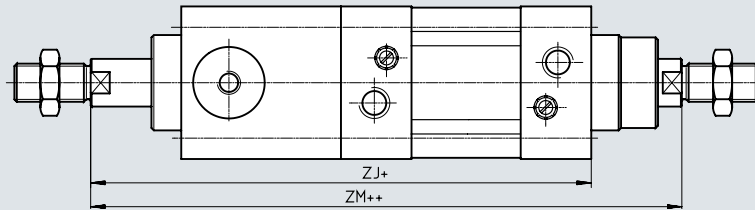

Note

The thread types at both piston rod ends are identical.

In combination with variant Q, the left-hand piston rod is round, the right-hand piston rod square.

The clamping unit is mounted on the left-hand, round piston rod.

+ = plus stroke length
++ = plus 2x stroke length

K2 – Extended male piston rod thread

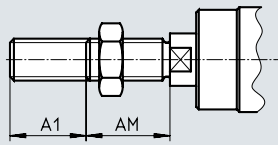

K3 – Female piston rod thread

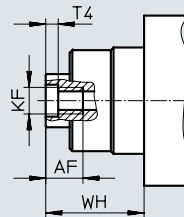

K5 – Custom piston rod thread

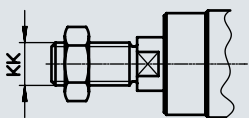

K7 – Piston rod with external hexagon

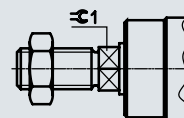

K8 – Extended piston rod

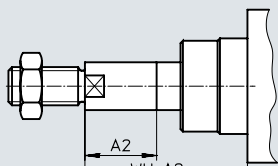

Note

In combination with variant S2, the piston rod is extended at one end.

The clamping unit is mounted on the side of the piston rod that is not extended.

If variant Q is also required, only the square piston rod is extended.

∅ [mm]	A1 max.	A2 max.	AF	AM	B1 □	KF	KK		T4	WH	ZJ	ZM	≈G1
							Basic thread	Custom thread ¹⁾					
32	35	500	12	22	10	M6	M10x1.25	M10	2.6	26	165	193	10
40	35	500	12	24	12	M8	M12x1.25	M12	3.3	30	188	220	13
50	70	500	16	32	16	M10	M16x1.5	M16	4.7	37	210	250	17
63	70	500	16	32	16	M10	M16x1.5	M16	4.7	37	234	275	17
80	70	500	20	40	20	M12	M20x1.5	M20	6.1	46	269	317	22
100	70	500	20	40	20	M12	M20x1.5	M20	6.1	51	287	338	22
125	70	500	32	54	–	M16	M27x2	M27	8	65	350	416	27

1) The custom threads are only available as male threads. The mounting nut on the piston rod thread is included in the scope of delivery

Ordering data – Modular product system

Ordering table										
Size	32	40	50	63	80	100	125	Conditions	Code	Enter code
Module no.	163302	163334	163366	163398	163430	163462	163494			
Function	Standards-based cylinders, double-acting, standard hole pattern, with clamping unit								DNC	DNC
Piston ø [mm]	32	40	50	63	80	100	125		-...	
Stroke [mm]	10 ... 2000								-...	
Cushioning	Elastic cushioning rings/pads at both ends								-P	
	Pneumatic cushioning, adjustable at both ends								-PPV	
Position sensing	Via proximity switch								-A	
Protection against rotation	Square piston rod						-	[1]	-Q	
Piston rod type	Through piston rod							[2]	-S2	

- [1] Q Max. stroke: 10 ... 1500 mm
 In combination with S2: square piston rod at bearing cap end only
 In combination with KP: only supplied with S2
 Not with K7
- [2] S2 In combination with K2: thread extension at both ends
 In combination with K3: female thread at both ends
 In combination with K5: special thread at both ends
 In combination with K8: piston rod extension at bearing cap end only
 In combination with KP: clamping unit on end cap
 Not with K7

Ordering data – Modular product system

Ordering table											
Size	32	40	50	63	80	100	125	Conditions	Code	Enter code	
Extended male thread [mm]	Extended male piston rod thread 1 ... 35 1 ... 70							[3]	-...K2		
Female thread	Piston rod with female thread (M6) (M8) (M10) (M10) (M12) (M12) (M16)							[4]	-K3		
Custom thread	Custom thread on the piston rod M10 M12 M16 M16 M20 M20 M27								-...K5		
Special spanner flats	Piston rod with external hexagon								-K7		
Extended piston rod [mm]	Extended piston rod 1 ... 500								-...K8		
Clamping unit	Attached							[5]	-KP	-KP	
Cylinder/valve combination	Single solenoid valve, mounted on right, piston rod retracted when unactuated						-	[6]	-V1		
	Single solenoid valve, mounted on right, piston rod advanced when unactuated						-	[6]	-V2		
	Double solenoid valve, mounted on right						-	[6]	-V3		
	Single solenoid valve, mounted on left, piston rod retracted when unactuated						-	[6]	-V4		
	Single solenoid valve, mounted on left, piston rod advanced when unactuated						-	[6]	-V5		
	Double solenoid valve, mounted on left						-	[6]	-V6		

[3] K2 Not with K3

[4] K3 With K5: on request
Not with K7

[5] KP Without S2: clamping unit positioned at the bearing cap

[6] V... Min. stroke: 100 mm

Ordering data

Sets of wearing parts	Part no.	Type
Piston \varnothing	Basic version	
32	369195	DNC-32-...-PPV-(A)
40	369196	DNC-40-...-PPV-(A)
50	369197	DNC-50-...-PPV-(A)
63	369198	DNC-63-...-PPV-(A)
80	369199	DNC-80-...-PPV-(A)
100	369200	DNC-100-...-PPV-(A)
125	369201	DNC-125-...-PPV-(A)

Data sheet

Function

DNC-...-A-...-EL

With position sensing

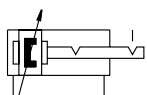
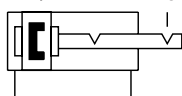

⌀ - Diameter
32 ... 125 mm

— - Stroke length
10 ... 2000 mm

 www.festo.com

Sets of wearing parts
→ Page 24

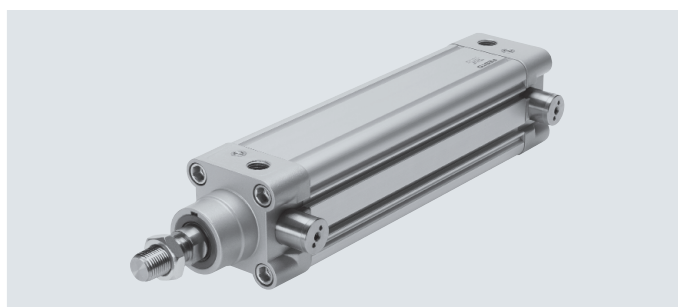
**Note.**

If used in safety-relevant applications, additional measures are necessary, e.g. in Europe the standards listed in the EC Machinery Directive must be observed.

Without additional measures in accordance with legally specified minimum requirements, the product is not suitable as a safety-related component in control systems

General technical data		32	40	50	63	80	100
Piston Ø		32	40	50	63	80	100
Pneumatic connection		G1/8	G1/4	G1/4	G3/8	G3/8	G1/2
Piston rod thread		M10x1.25	M12x1.25	M16x1.5	M16x1.5	M20x1.5	M20x1.5
Max. axial backlash with end position locked	[mm]	≤ 1.3				≤ 2.1	
Design		Piston					
		Piston rod					
		Profile barrel					
End-position locking	ELB	At both ends					
	ELV	Front					
	ELH	Rear					
Cushioning		Elastic cushioning rings/pads at both ends					
		Pneumatic cushioning, adjustable at both ends					
Cushioning length PPV [mm]		20	20	22	22	32	32
	EL	8.2	8.3	7.3	10.8	9.8	11.8
Position sensing		Via proximity switch					
Type of mounting		With female thread					
		Via accessories					
Mounting position		Any					

† - Note: This product conforms to ISO 1179-1 and ISO 228-1.

**Note**

- End-position locking should only be used in conjunction with double-acting cylinders with exhaust air flow control in order to ensure that the lock is always completely released prior to starting the drive movement.
- Screws with a head or similar must not be used in place of end-position locking, as there is a risk that the function will be impaired if they are screwed in too deeply.
- The exhaust bore must not be closed.
- Locking can be activated from any stroke position once the drive is brought mechanically into its end position.
- End-position locking has been designed to prevent the load from dropping in case of pressure failure.
- A very tightly set end-position cushioning (more than 50% closed) can result in the locking bolt not engaging reliably, resulting in premature wear.

Data sheet

Operating and environmental conditions						
Piston ø	32	40	50	63	80	100
Operating medium	Compressed air to ISO 8573-1:2010 [7:4:4]					
Note on operating/pilot medium	Lubricated operation possible (in which case lubricated operation will always be required)					
Operating pressure [bar]	2.5 ... 12		1.5 ... 12			
Ambient temperature ¹⁾ [°C]	-20 ... +80					
Corrosion resistance class CRC ²⁾	2					

1) Note operating range of proximity switches

2) Corrosion resistance class CRC 2 to Festo standard FN 940070

Moderate corrosion stress. Indoor applications in which condensation can occur. External visible parts with primarily decorative surface requirements which are in direct contact with a normal industrial environment.

Impact energy [J]						
Piston ø	32	40	50	63	80	100
Max. impact energy at the end positions	0.1	0.2	0.2	0.5	0.9	1.2

Permissible impact velocity: $v = \sqrt{\frac{2 \cdot E}{m_1}}$ V

Maximum permissible mass: $m_2 = \frac{2 \cdot E}{v^2} - m_1$ m1

m2

Permissible impact velocity

Max. impact energy

Moving mass (drive)

Moving payload

 **Note**
These specifications represent the maximum values that can be achieved. The maximum permissible impact energy must be observed.

Forces [N]						
Piston ø	32	40	50	63	80	100
Theoretical force at 6 bar, advancing	483	754	1178	1870	3016	4712
Theoretical force at 6 bar, retracting	415	633	990	1682	2721	4418
Static holding force	500		2000		5000	

Sizing example

 **Note**
When sizing pneumatic cylinders it is recommended as a basic principle that only 50% of the indicated theoretical forces (see above) be used.

Assuming:

Mounting position = vertical

Workpiece load = 44 kg

$$F = m \times g = 44 \text{ kg} \times 9.81 \text{ m/s}^2 = 431.6 \text{ N}$$

Required:

Suitable piston diameter

Example with 32 mm piston diameter:

Theoretical force at 6 bar, advancing = 483 N

50% of the theoretical force = 241.5 N

Static holding force with 32 mm piston diameter = 500 N

The static holding force of end-position locking is within the permissible range (max. 500 N) for a workpiece load of 44 kg (431.6 N); however, the cylinder would be at 89% capacity.

Result:

A cylinder with a piston diameter of 40 mm is therefore recommended for this application.

Data sheet

Max. transverse force F_q as a function of stroke length l

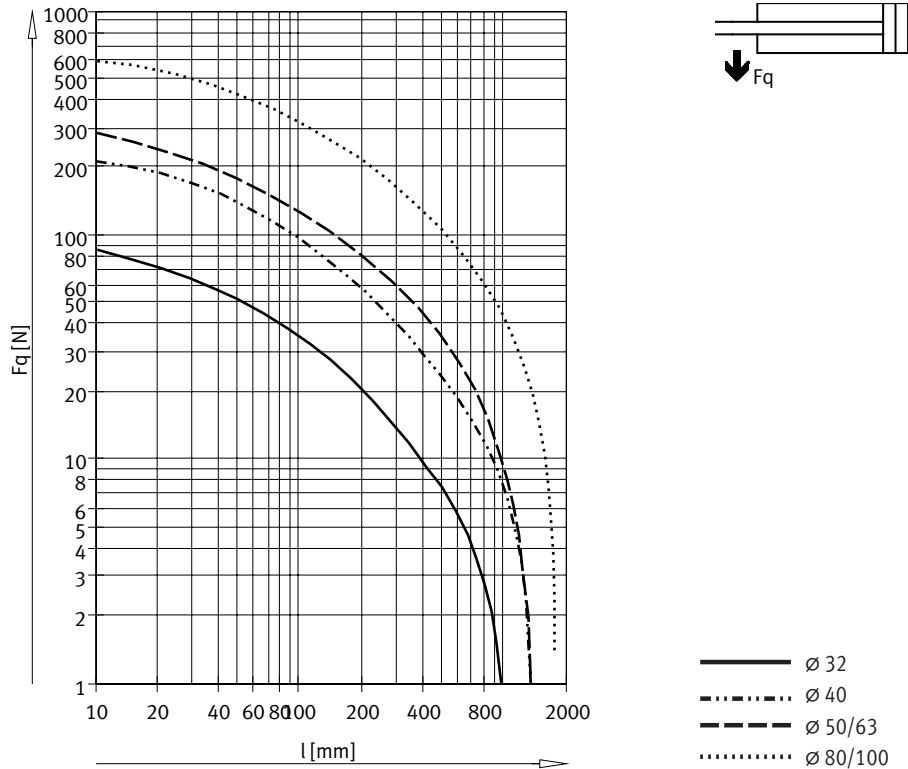

Weight [g]						
Piston ø	32	40	50	63	80	100
Basic version						
Product weight with 0 mm stroke	537	820	1320	1769	2970	4833
Additional weight per 10 mm stroke	30	45	64	73	106	115
S2 – Through piston rod						
Product weight with 0 mm stroke	596	915	1450	1977	3294	5477
Additional weight per 10 mm stroke	39	61	89	98	144	153

Materials

Sectional view

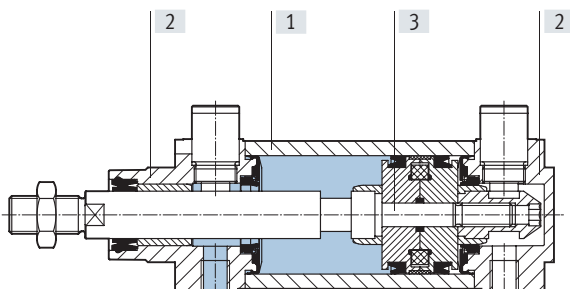

Standards-based cylinder	
[1] Profile barrel	Smooth-anodised wrought aluminium alloy
[2] Bearing and end caps	Die-cast aluminium
[3] Piston rod	High-alloy steel
- Seals	Polyurethane, nitrile rubber
Note on materials	RoHS-compliant
PWIS conformity	VDMA24364-B1/B2-L

Data sheet

Dimensions – Basic version

Download CAD data → www.festo.com

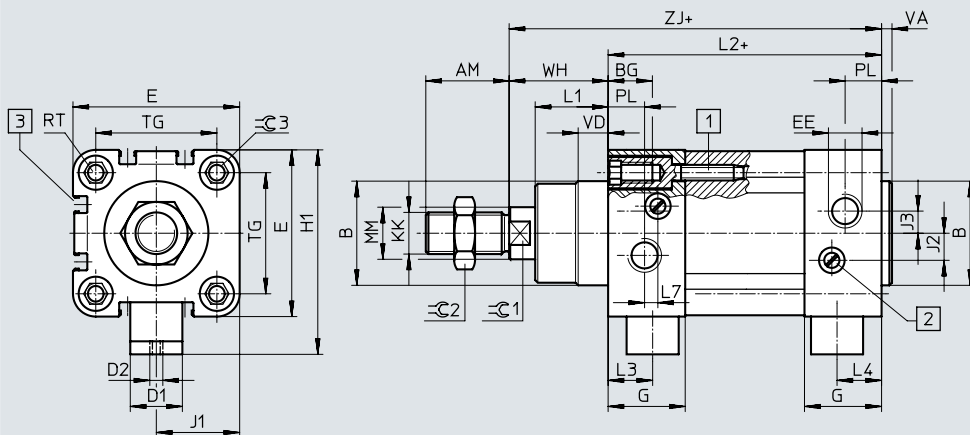

- [1] Socket head screw with female thread for mounting components
- [2] Adjusting screw for adjustable end-position cushioning
- [3] Sensor slot for proximity switch
- + = plus stroke length

Dimensions – Variants

Download CAD data → www.festo.com

S2 – Through piston rod

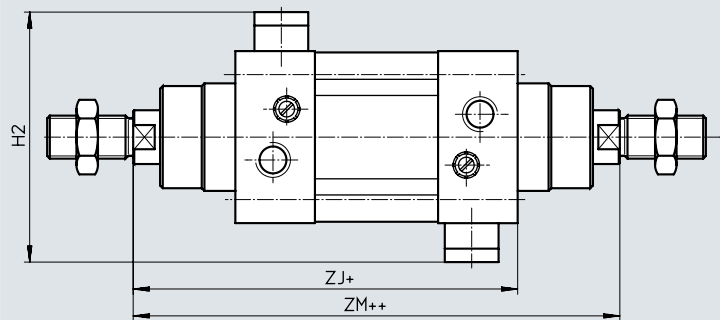

- + = plus stroke length
- ++ = plus 2x stroke length

∅	AM	B ∅ d11	BG	D1 ∅ f8	D2	E	EE	G	H1	H2	J1	J2	J3	KK	L1
32	22	30	16	13	M3	45	G1/8	25.1	57.5	70	22.5	6	5.2	M10x1.25	18
40	24	35	16	13	M3	54	G1/4	29.6	64	74	27	8	6	M12x1.25	21.5
50	32	40	17	20	M5	64	G1/4	29.6	78.5	93	32	10.4	8.5	M16x1.5	28
63	32	45	17	20	M5	75	G3/8	35.6	84.5	93	37.5	12.4	10	M16x1.5	28.5
80	40	45	17	30	M5	93	G3/8	35.9	104.5	116	46.5	12.5	8	M20x1.5	34.7
100	40	55	17	30	M5	110	G1/2	38.8	113.5	116	55	12	10	M20x1.5	38.2

∅	L2	L3	L4	L7	MM ∅	PL	RT	TG	VA	VD	WH ±2	ZM	ZJ	∅C1	∅C2	∅C3
32	94	13.8	12	3.3	12	15.6	M6	32.5	4	10	26	148	120	10	16	6
40	105	16.6	16.6	3.6	16	14	M6	38	4	10.5	30	167	135	13	18	6
50	106	17.1	17.1	5.1	20	14	M8	46.5	4	11.5	37	183	143	17	24	8
63	121	16.6	16.6	6.6	20	17	M8	56.5	4	15	37	199	158	17	24	8
80	128	19.9	19.9	10.5	25	16.4	M10	72	4	15.7	46	222	174	22	30	6
100	138	22.8	22.8	8	25	18.8	M10	89	4	19.2	51	240	189	22	30	6

† Note: This product conforms to ISO 1179-1 and ISO 228-1.

Data sheet

Dimensions – Variants

Download CAD data → www.festo.com

K2 – Extended male piston rod thread

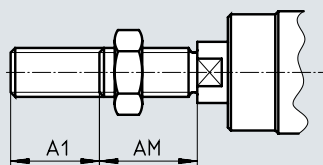

K3 – Female piston rod thread

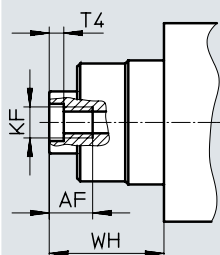

K5 – Custom piston rod thread

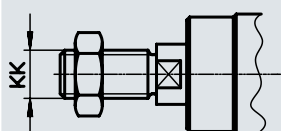

K8 – Extended piston rod

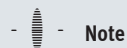
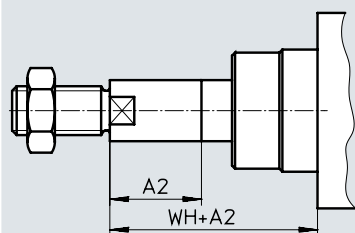
**Note**

In combination with variant S2, the piston rod is extended at one end.

∅ [mm]	A1 max.	A2 max.	AF	AM	KF	KK		T4	WH	=C1
						Basic thread	Custom thread ¹⁾			
32	35	500	12	22	M6	M10x1.25	M10	2.6	26	10
40	35	500	12	24	M8	M12x1.25	M12	3.3	30	13
50	70	500	16	32	M10	M16x1.5	M16	4.7	37	17
63	70	500	16	32	M10	M16x1.5	M16	4.7	37	17
80	70	500	20	40	M12	M20x1.5	M20	6.1	46	22
100	70	500	20	40	M12	M20x1.5	M20	6.1	51	22

1) The custom threads are only available as male threads. The mounting nut on the piston rod thread is included in the scope of delivery

Ordering data – Modular product system

Ordering table										
Size	32	40	50	63	80	100	Conditions	Code	Enter code	
Module no.	163302	163334	163366	163398	163430	163462				
Function	Standards-based cylinders, double-acting, standard hole pattern, with end-position locking								DNC	DNC
Piston ø [mm]	32	40	50	63	80	100		-...		
Stroke [mm]	10 ... 2000								-...	
Cushioning	Elastic cushioning rings/pads at both ends								-P	
	Pneumatic cushioning, adjustable at both ends								-PPV	
Position sensing	Via proximity switch								-A	
Piston rod type	Through piston rod							[1]	-S2	

- [1] S2 In combination with K2: thread extension at both ends
 In combination with K3: female thread at both ends
 In combination with K5: custom thread at both ends

Ordering data – Modular product system

Ordering table									
Size	32	40	50	63	80	100	Conditions	Code	Enter code
Extended male thread [mm]	Extended male piston rod thread						[2]	-...K2	
	1 ... 35		1 ... 70						
Female thread	Piston rod with female thread						[3]	-K3	
	(M6)	(M8)	(M10)	(M10)	(M12)	(M12)			
Custom thread	Custom thread on the piston rod							-...K5	
	M10	M12	M16	M16	M20	M20			
Extended piston rod [mm]	Extended piston rod							-...K8	
	1 ... 500								
End-position locking	At both ends						[4]	-ELB	
	Front						[4]	-ELV	
	Rear						[4]	-ELH	

[2] K2

Not with K3

[3] K3

With K5: on request

[4] ELB, ELV, ELH

In combination with K8 and S2 on request only

Data sheet

Function

DNC-...

Without position sensing

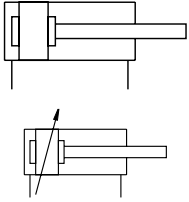

-  - Diameter
32 ... 100 mm

-  - Stroke length
100 ... 2000 mm

-  - www.festo.com

DNC-...-A-...

With position sensing

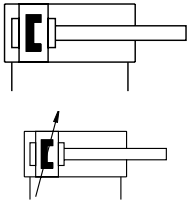

Sets of wearing parts
→ Page 32

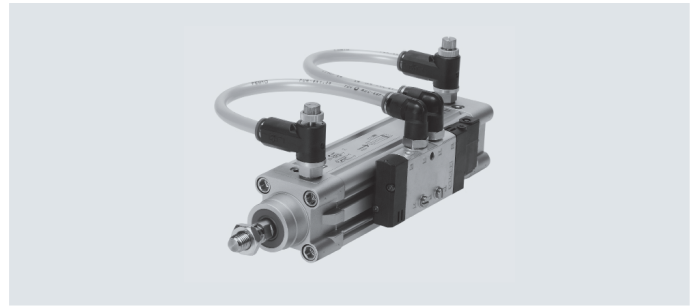

Valve variants

Single solenoid valve unactuated, piston rod retracted



DNC- ... -V1 – mounted on right

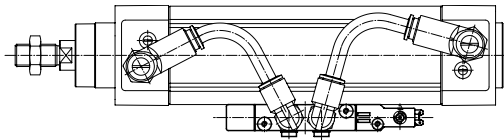

DNC- ... -V4 – mounted on left

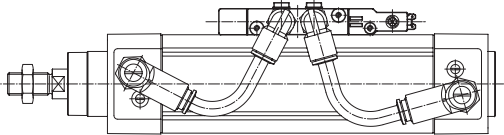

Single solenoid valve unactuated, piston rod advanced



DNC- ... -V2 – mounted on right

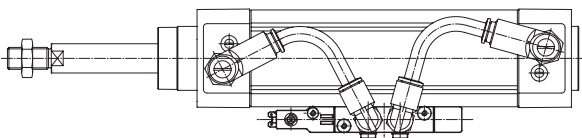

DNC- ... -V5 – mounted on left

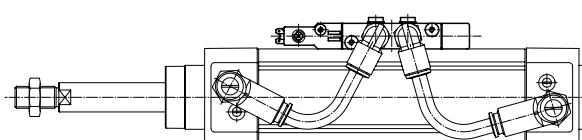

Double solenoid valve unactuated, piston rod retracted

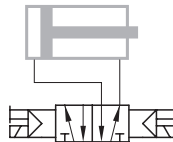

DNC- ... -V3 – mounted on right

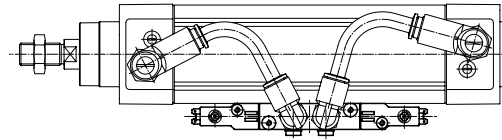

DNC- ... -V6 – mounted on right

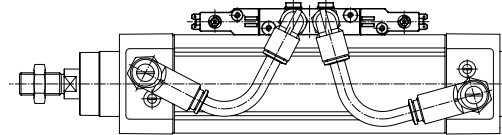

-  - **Note**
Mounted on left or right refers to looking at the piston rod from the front.

In this example, the valve is mounted on the right.

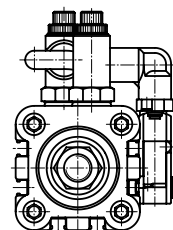

Data sheet

General technical data		32	40	50	63	80	100
Piston Ø							
Cylinder							
Pneumatic connection		G1/8	G1/4	G1/4	G3/8	G3/8	G1/2
Piston rod thread		M10x1.25	M12x1.25	M16x1.5	M16x1.5	M20x1.5	M20x1.5
	K3	M6	M8	M10	M10	M12	M12
	K5	M10	M12	M16	M16	M20	M20
Design		Piston					
		Piston rod					
		Profile barrel					
Cushioning		Elastic cushioning rings/pads at both ends					
		Pneumatic cushioning, adjustable at both ends					
Cushioning length PPV	[mm]	20	20	22	22	32	32
Position sensing		Via proximity switch					
Type of mounting		With female thread					
		Via accessories					
Mounting position		Any					
Valve		Ordering data – Valve and accessories → page 48					
Valve used	Single solenoid	CPE14-M1BH-5L-1/8		CPE18-M1H-5L-1/4		CPE24-M1H-5L-3/8	
	Double solenoid	CPE14-M1BH-5J-1/8		CPE18-M1H-5J-1/4		CPE24-M1H-5J-3/8	
Pneumatic connection		G1/8		G1/4		G3/8	
Design		Piston spool valve					
Type of mounting		Via mounting kit					
Operating voltage	[V DC]	24 +10/-15%					
Power consumption	[W]	1		1.5			
Duty cycle		100%					
Degree of protection with plug socket		IP65					

† Note: This product conforms to ISO 1179-1 and ISO 228-1.

Operating and environmental conditions		32	40	50	63	80	100
Piston Ø							
Operating medium		Compressed air to ISO 8573-1:2010 [7:4:4]					
Note on operating/pilot medium		Lubricated operation possible (in which case lubricated operation will always be required)					
Operating pressure [bar]		3 ... 8		2.5 ... 10			
	Q	1 ... 12					
Ambient temperature ¹⁾	[°C]	0 ... +50					
Corrosion resistance class CRC ²⁾		2					

1) Note operating range of proximity switches

2) Corrosion resistance class CRC 2 to Festo standard FN 940070

Moderate corrosion stress. Indoor applications in which condensation can occur. External visible parts with primarily decorative surface requirements which are in direct contact with a normal industrial environment.

Data sheet

Forces [N] and impact energy [J]		32	40	50	63	80	100
Piston ø		32	40	50	63	80	100
Theoretical force at 6 bar, advancing		483	754	1178	1870	3016	4712
	S2/S20	415	633	990	1682	2721	4418
Theoretical force at 6 bar, retracting		415	633	990	1682	2721	4418
	S2/S20	415	633	990	1682	2721	4418
Max. impact energy at the end positions ¹⁾		0.1	0.2	0.2	0.5	0.9	1.2

1) With variant K10 and S20, the permissible impact energy is reduced by approx. 10%

Permissible impact velocity:

$$\sqrt{2 \cdot E}$$

V Permissible impact velocity

Maximum permissible mass:

$$m_2 = \frac{2 \cdot E}{V^2} - m_1$$

E Max. impact energy

m1 Moving mass (drive)

m2 Moving payload

Note
 These specifications represent the maximum values that can be achieved. The maximum permissible impact energy must be observed.

Max. transverse load Fq as a function of stroke length l

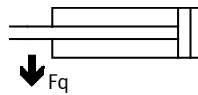
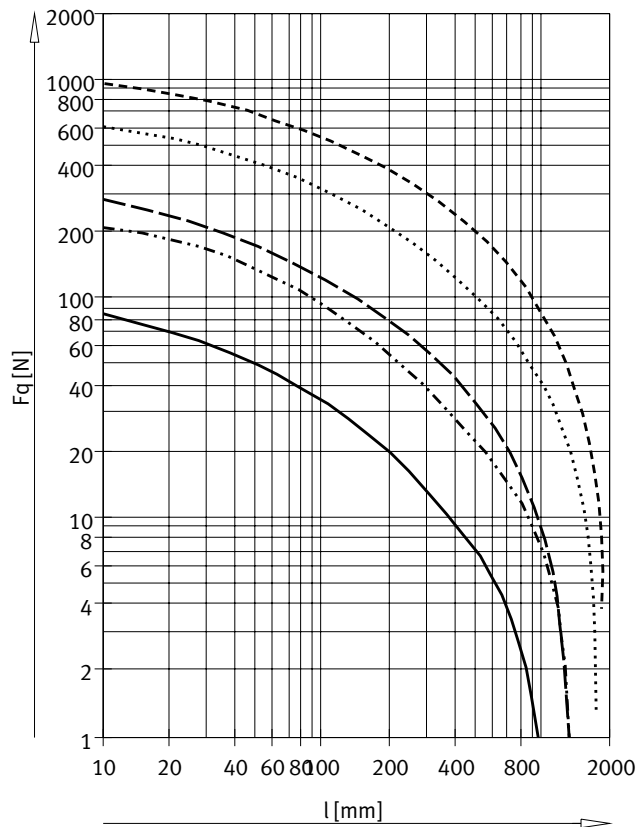

- ø 32
- · - · - · ø 40
- - - - - ø 50/63
- · · · · ø 80/100

Data sheet

Materials

Sectional view

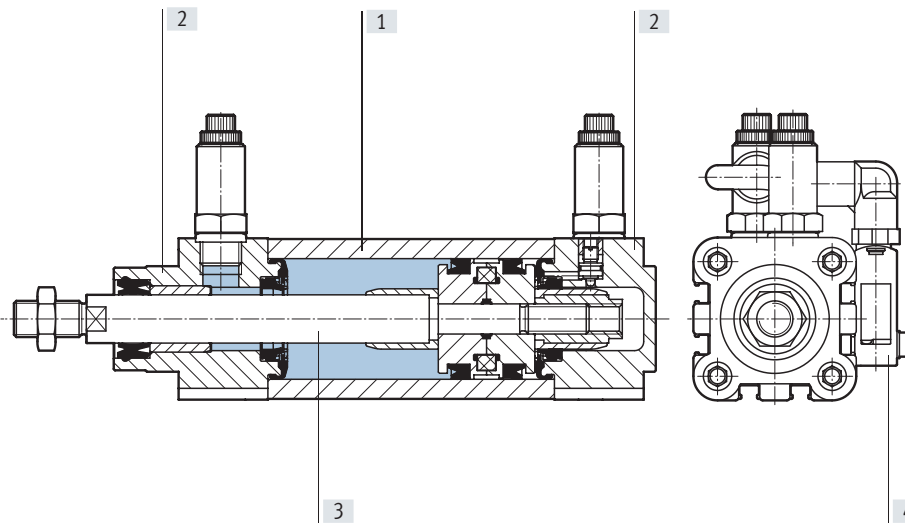

Standards-based cylinder	Basic version	R8	S10	S11	K10
[1] Profile barrel	Smooth-anodised wrought aluminium alloy				
[2] Bearing and end caps	Die-cast aluminium				
[3] Piston rod	High-alloy steel	Tempered steel	High-alloy steel		Anodised wrought aluminium alloy
- Seals, cylinder	Polyurethane, nitrile rubber		Fluoro rubber		Polyurethane, nitrile rubber
[4] Housing, valve	Die-cast aluminium, polyamide, steel				
- Seals, valve	Nitrile rubber				
Note on materials	RoHS-compliant				
PWIS conformity	VDMA24364-B1/B2-L		VDMA24364 zone III		VDMA24364-B1/B2-L

Data sheet

Dimensions

Download CAD data → www.festo.com

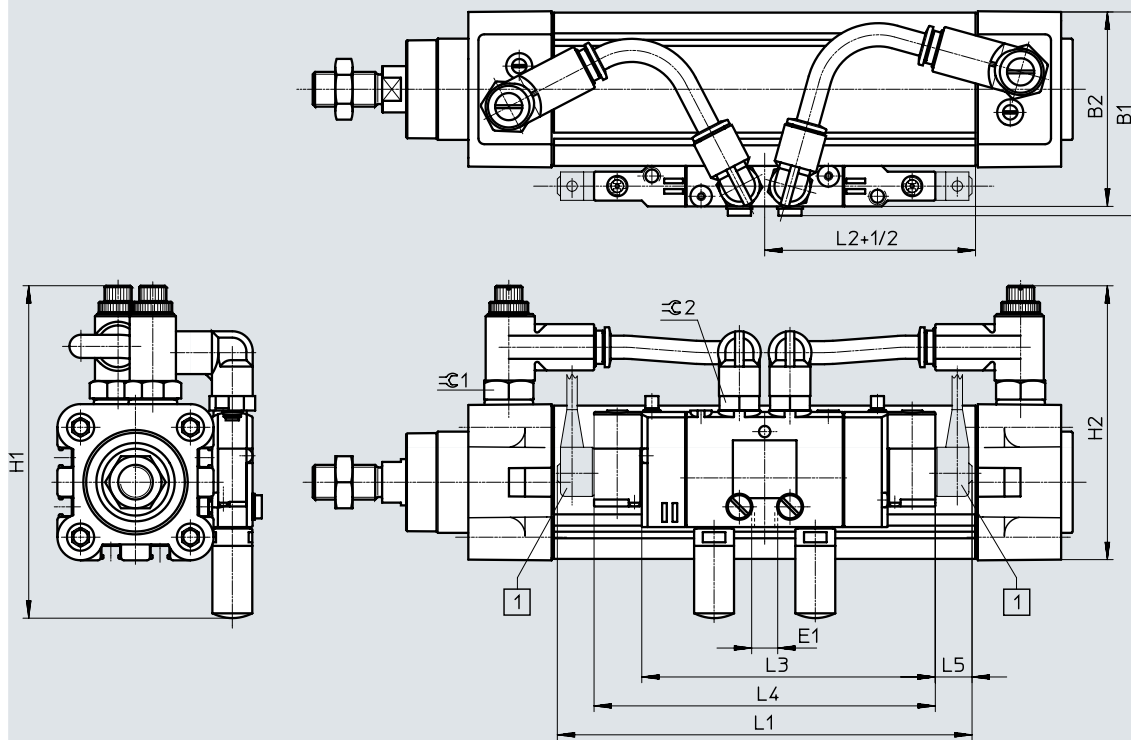

[1] Connecting cable not included
in scope of delivery

+1/2 = plus half stroke length

Data sheet

∅ [mm]	B1	B2	E1	H1	H2	L1 max.	L2 ±3	L3	L4	L5	≈C1	≈C2
32	62	59	G1/8	94 ^{+1.4}	71 ^{+1.4}	136	22	102	118	13	13	14
40	71	68	G1/8	106 ^{+1.9}	86 ^{+1.9}	136	23	102	118	13	17	14
50	86	82	G1/4	123 ^{+1.9}	96 ^{+1.9}	209	24	138	163	23	17	14
63	97	93	G1/4	138 ^{+2.2}	111 ^{+2.2}	209	25	138	163	23	19	14
80	123	119	G3/8	190 ^{+2.2}	129 ^{+2.2}	236	28	165	190	23	19	17
100	140	136	G3/8	213 ^{+2.0}	158 ^{+2.0}	236	30	165	190	23	27	17

† Note: This product conforms to ISO 1179-1 and ISO 228-1.

**Note**

Additional dimensions relating to the basic type and its variants can be found on
 → page 15,
 with clamping unit on
 → page 28.

Ordering data – Modular product system

Ordering table									
Size	32	40	50	63	80	100	Conditions	Code	Enter code
Module no.	163302	163334	163366	163398	163430	163462			
Function	Standards-based cylinders, double-acting, standard hole pattern, cylinder/valve combination							DNC	DNC
Piston ø [mm]	32	40	50	63	80	100		-...	
Stroke [mm]	100 ... 2000							-...	
Cushioning	Elastic cushioning rings/pads at both ends							-P	
	Pneumatic cushioning, adjustable at both ends							-PPV	
Position sensing	Via proximity switch							-A	
Protection against rotation	Square piston rod						[1]	-Q	
Piston rod type	Through piston rod						[2]	-S2	
	Through, hollow piston rod						[3]	-S20	

- [1] Q Max. stroke: 100 ... 1500 mm
 In combination with S2: square piston rod at bearing cap end only
 In combination with KP: only supplied with variant S2
 Not with S20, K7, K10, S10, S11
- [2] S2 In combination with K2: thread extension at both ends
 In combination with K3: female thread at both ends
 In combination with K5: special thread at both ends
 In combination with K8: piston rod extension at bearing cap end only
 In combination with KP: clamping unit on end cap
 Not with S20, K7, S10, S11
- [3] S20 Max. stroke: 850 mm
 Not with K2, K3, K5, K8, K10, KP, S10, S11

Ordering data – Modular product system

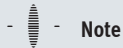

Ordering table										
Size	32	40	50	63	80	100	Conditions	Code	Enter code	
Extended male thread [mm]	Extended male piston rod thread 1 ... 35 1 ... 70						[4]	-...K2		
Female thread	Piston rod with female thread (M6) (M8) (M10) (M10) (M12) (M12)						[5]	-K3		
Custom thread	Custom thread on the piston rod M10 M12 M16 M16 M20 M20						[6]	-...K5		
Special spanner flats	Piston rod with external hexagon						[7]	-K7		
Extended piston rod [mm]	Extended piston rod 1 ... 500							-...K8		
Improved running performance	Smooth anodised aluminium piston rod						[8]	-K10		
Clamping unit	Attached						[9]	-KP		
Constant motion	Slow speed (constant motion at low piston speeds)						[10]	-S10		
Running characteristic	Low friction						[11]	-S11		
Cylinder/valve combination	Single solenoid valve, mounted on right, unactuated piston rod, retracted							-V1		
	Single solenoid valve, mounted on right, unactuated piston rod, advanced							-V2		
	Double solenoid valve, mounted on right							-V3		
	Single solenoid valve, mounted on left, unactuated piston rod, retracted							-V4		
	Single solenoid valve, mounted on left, unactuated piston rod, advanced							-V5		
	Double solenoid valve, mounted on left							-V6		

- [4] K2 Not with K3, K10
 [5] K3 With K5: on request
 Not with K7
 [6] K5 Not with K10
 [7] K7 Not with Q, S2, K10
 [8] K10 Max. stroke: 1000 mm
 Not with KP
 [9] KP Without S2: clamping unit positioned at the bearing cap
 Not with S10, S11
 [10] S10 Max. stroke: 500 mm; additional strokes on request
 Not with S11
 [11] S11 Max. stroke: 500 mm; additional strokes on request

**Note**

If feature ...K5 (custom thread) is selected, the scope of delivery does not include the piston rod nut.

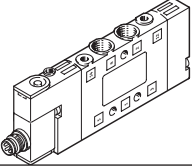
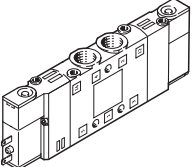
Accessories

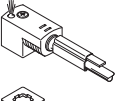
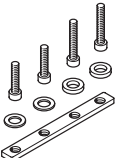
Ordering data – Valves		For ø	Pneumatic connection	Degree of protection	Part no.	Type	Data sheets → Internet: cpe
		[mm]					
Single solenoid							
	32	G1/8	IP65	196941	CPE14-M1BH-5L-1/8		
	40						
	50	G1/4	IP65	163142	CPE18-M1H-5L-1/4		
	63						
	80	G3/8	IP65	163166	CPE24-M1H-5L-3/8		
100							
Double solenoid							
	32	G1/8	IP65	196939	CPE14-M1BH-5J-1/8		
	40						
	50	G1/4	IP65	163143	CPE18-M1H-5J-1/4		
	63						
	80	G3/8	IP65	163167	CPE24-M1H-5J-3/8		
100							
Ordering data – Valve accessories							
		For valve			Part no.	Type	PU ¹⁾
Push-in fitting QS							
	CPE14			153015	QS-1/8-8-I		10
	CPE18			153018	QS-1/4-10-I		
	CPE24			153020	QS-3/8-12-I		
Connecting cable NEBV/KMEB							
	CPE14	Cable length: 2.5 m		8047679	NEBV-Z4WA2L-R-E-2.5-N-LE2-S1		1
		Cable length: 5 m		8047680	NEBV-Z4WA2L-R-E-5-N-LE2-S1		
	CPE18	Cable length: 2.5 m		151688	KMEB-1-24-2.5-LED		1
	CPE24	Cable length: 5 m		151689	KMEB-1-24-5-LED		
		Cable length: 10 m		193457	KMEB-1-24-10-LED		
Mounting kit ZVB							
	CPE14			185705	ZVB-8-1 4/18		-
	CPE18						
	CPE24			187388	ZVB-8-24		-

1) Packaging unit

Accessories

Multi-position kit DPNC

Material:
 Flange: Wrought aluminium alloy
 Threaded pins, hex nuts: Galvanised steel
 RoHS-compliant

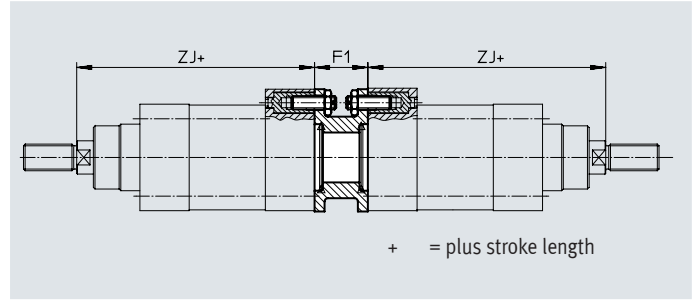
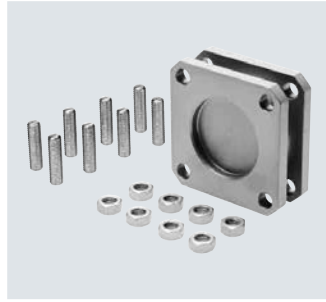

Dimensions and ordering data

For \varnothing [mm]	F1	Z		Max. total stroke [mm]	Weight [g]	Part no.	Type ¹⁾
		Basic version	KP				
32	27	120	165	500	292	174418	DPNC-32
40	27	135	188	800	410	174419	DPNC-40
50	32	143	210	800	335	174420	DPNC-50
63	28	158	234	700	390	174421	DPNC-63
80	38	174	269	1000	847	174422	DPNC-80
100	38	189	287	900	1200	174423	DPNC-100
125	48	225	350	1000	2102	174424	DPNC-125

Note

The maximum total stroke length must not be exceeded when combining cylinders and multi-position kits.

Connecting two cylinders with the same piston diameter to form a three- or four-position cylinder

A three or four-position cylinder consists of two separate cylinders whose piston rods advance in opposing directions.

This means that depending on the actuation and stroke pattern, this type of cylinder can assume up to four positions. In each case the cylinder is moved precisely

against a stop. Note that when one end of the piston rod is fixed, the cylinder barrel

executes the movement. The connections to the cylinder must therefore be flexible.

To achieve 3 positions

Two cylinders with the same stroke length must be connected together.

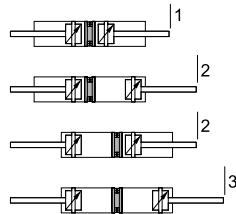

To achieve 4 positions

Two cylinders with different stroke lengths must be connected together.

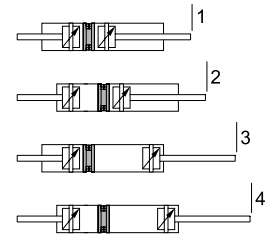

Accessories

Foot mounting HNC/CRHNC

Material:

HNC: Galvanised steel

CRHNC: high-alloy steel

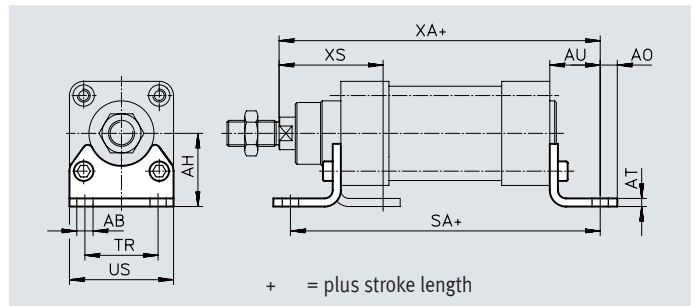

Dimensions and ordering data

For \varnothing [mm]	AB \varnothing	AH	AO	AT	AU	SA		TR	US	XA		XS
						DNC...	DNC...-KP			DNC...	DNC...-KP	
32	7	32	6.5	4	24	142	187	32	45	144	189	45
40	10	36	9	4	28	161	214	36	54	163	216	53
50	10	45	9.5	5	32	170	237	45	64	175	242	62
63	10	50	12.5	5	32	185	261	50	75	190	266	63
80	12	63	15	6	41	210	305	63	93	215	310	81
100	14.5	71	17.5	6	41	220	318	75	110	230	328	86
125	16.5	90	22	8	45	250	375	90	131	270	395	102

For \varnothing [mm]	Basic version				Corrosion-resistant			
	CRC ¹⁾	Weight [g]	Part no.	Type	CRC ¹⁾	Weight [g]	Part no.	Type
32	2	144	174369	HNC-32	4	139	176937	CRHNC-32
40	2	193	174370	HNC-40	4	188	176938	CRHNC-40
50	2	353	174371	HNC-50	4	341	176939	CRHNC-50
63	2	436	174372	HNC-63	4	424	176940	CRHNC-63
80	2	829	174373	HNC-80	4	809	176941	CRHNC-80
100	2	1009	174374	HNC-100	4	990	176942	CRHNC-100
125	2	1902	174375	HNC-125	4	1920	176943	CRHNC-125

1) Corrosion resistance class CRC 2 to Festo standard FN 940070

Moderate corrosion stress. Indoor applications in which condensation can occur. External visible parts with primarily decorative surface requirements which are in direct contact with a normal industrial environment.

Corrosion resistance class CRC 4 to Festo standard FN 940070

Particularly high corrosion stress. Outdoor exposure under extreme corrosive conditions. Parts exposed to aggressive media, e.g. in the chemical or food industries. Such applications may need to be safeguarded by means of special testing (→ also FN 940082), using appropriate media.

Accessories

Flange mounting FNC/CRFNG

Material:

FNC: Galvanised steel

CRFNG: high-alloy steel

RoHS-compliant

Cannot be used on the bearing cap in combination with bellows kit DADB.

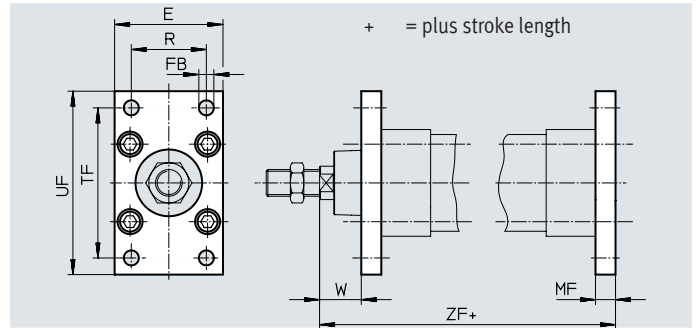
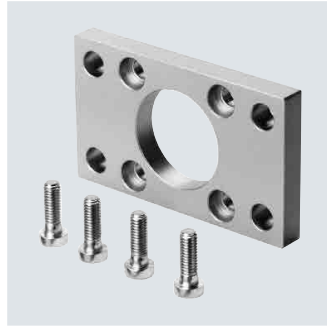

Dimensions and ordering data

For \varnothing [mm]	E	FB \varnothing H13	MF	R	TF	UF	W	ZF	
								DNC...	DNC...-KP
32	45	7	10	32	64	80	16	130	175
40	54	9	10	36	72	90	20	145	198
50	65	9	12	45	90	110	25	155	222
63	75	9	12	50	100	120	25	170	246
80	93	12	16	63	126	150	30	190	285
100	110	14	16	75	150	175	35	205	303
125	132	16	20	90	180	210	45	245	370

For \varnothing [mm]	Basic version				Corrosion-resistant			
	CRC ¹⁾	Weight [g]	Part no.	Type	CRC ¹⁾	Weight [g]	Part no.	Type
32	1	221	174376	FNC-32	4	220	161846	CRFNG-32
40	1	291	174377	FNC-40	4	291	161847	CRFNG-40
50	1	536	174378	FNC-50	4	526	161848	CRFNG-50
63	1	679	174379	FNC-63	4	680	161849	CRFNG-63
80	1	1495	174380	FNC-80	4	1508	161850	CRFNG-80
100	1	2041	174381	FNC-100	4	2054	161851	CRFNG-100
125	1	3775	174382	FNC-125	4	3787	185363	CRFNG-125

1) Corrosion resistance class CRC 1 to Festo standard FN 940070

Low corrosion stress. Dry indoor application or transport and storage protection. Also applies to parts behind covers, in the non-visible interior area, and parts which are covered in the application (e.g. drive trunnions).

Corrosion resistance class CRC 4 to Festo standard FN 940070

Particularly high corrosion stress. Outdoor exposure under extreme corrosive conditions. Parts exposed to aggressive media, e.g. in the chemical or food industries. Such applications may need to be safeguarded by means of special testing (→ also FN 940082), using appropriate media.

Accessories

Trunnion flange ZNCF/CRZNG

Material:

ZNCF: Stainless steel casting

CRZNG: Electropolished stainless steel casting

RoHS-compliant

Cannot be used on the bearing cap in combination with bellows kit DADB.

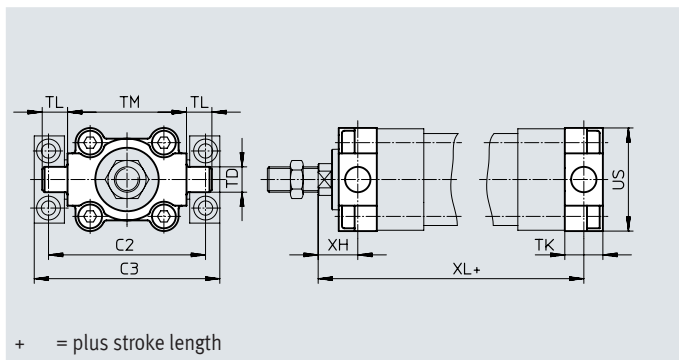

+ = plus stroke length

Dimensions and ordering data

For \varnothing [mm]	C2	C3	TD \varnothing e9	TK	TL	TM	US	XH	XL	
									DNC...	DNC...-KP
32	71	86	12	16	12	50	45	18	128	173
40	87	105	16	20	16	63	54	20	145	198
50	99	117	16	24	16	75	64	25	155	222
63	116	136	20	24	20	90	75	25	170	246
80	136	156	20	28	20	110	93	32	188	283
100	164	189	25	38	25	132	110	32	208	306
125	192	217	25	50	25	160	131	40	250	375

For \varnothing [mm]	Basic version				Corrosion-resistant			
	CRC ¹⁾	Weight [g]	Part no.	Type	CRC ¹⁾	Weight [g]	Part no.	Type
32	2	150	174411	ZNCF-32	4	150	161852	CRZNG-32
40	2	285	174412	ZNCF-40	4	285	161853	CRZNG-40
50	2	473	174413	ZNCF-50	4	473	161854	CRZNG-50
63	2	687	174414	ZNCF-63	4	687	161855	CRZNG-63
80	2	1296	174415	ZNCF-80	4	1296	161856	CRZNG-80
100	2	2254	174416	ZNCF-100	4	2254	161857	CRZNG-100
125	2	3484	174417	ZNCF-125	4	3484	185362	CRZNG-125

1) Corrosion resistance class CRC 2 to Festo standard FN 940070

Moderate corrosion stress. Indoor applications in which condensation can occur. External visible parts with primarily decorative surface requirements which are in direct contact with a normal industrial environment.

Corrosion resistance class CRC 4 to Festo standard FN 940070

Particularly high corrosion stress. Outdoor exposure under extreme corrosive conditions. Parts exposed to aggressive media, e.g. in the chemical or food industries. Such applications may need to be safeguarded by means of special testing (→ also FN 940082), using appropriate media.

Accessories

Trunnion flange kit DAMT for basic version DNC

The kit can be attached at any position along the profile barrel of the cylinder.

Material:
High-alloy steel

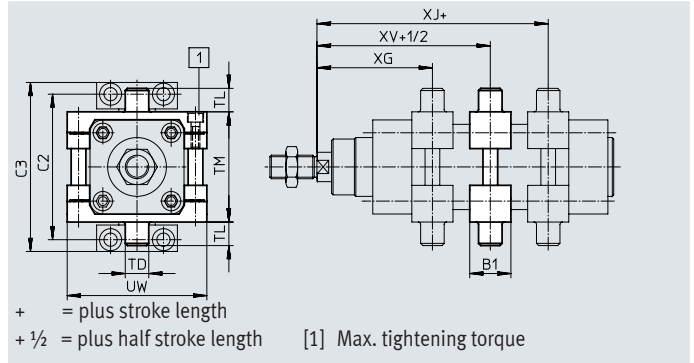
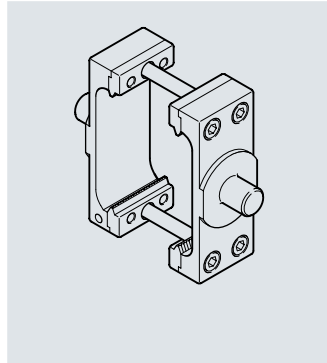

for DNC-KP

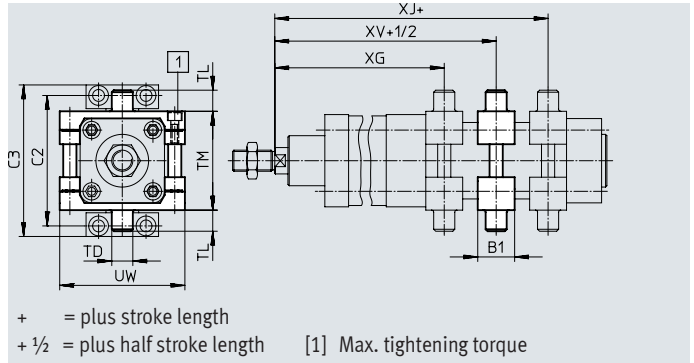

Dimensions and ordering data									
For \varnothing [mm]	B1	C2	C3	TD \varnothing e9	TL	TM	UW	XG	
								DNC...	DNC...-KP
32	30	71	86	12	12	50	65	66.1	111.1
40	32	87	105	16	16	63	75	75.6	128.6
50	34	99	117	16	16	75	95	83.6	150.6
63	41	116	136	20	20	90	105	93.1	169.1
80	44	136	156	20	20	110	130	103.9	198.9
100	48	164	189	25	25	132	145	113.8	211.8
125	50	192	217	25	25	160	175	134.7	259.7

For \varnothing [mm]	XJ		XV		Max. tightening torque [Nm]	CRC ¹⁾	Weight [g]	Part no.	Type
		KP		KP					
32	79.9	124.9	73	118	4+1	1	213	2213233	DAMT-V1-32-A
40	89.4	142.4	82.5	135.5	8+1	1	388	2214899	DAMT-V1-40-A
50	96.4	163.4	90	157	8+2	1	608	2214909	DAMT-V1-50-A
63	101.9	177.9	97.5	173.5	18+2	1	911	2214971	DAMT-V1-63-A
80	116.1	211.1	110	205	28+2	1	1494	163529	DAMT-V1-80-A
100	126.2	224.2	120	218	28+2	1	2095	163530	DAMT-V1-100-A
125	155.3	280.3	145	270	40+2	1	3013	163531	DAMT-V7-125-A

1) Corrosion resistance class CRC 1 to Festo standard FN 940070

Low corrosion stress. Dry indoor application or transport and storage protection. Also applies to parts behind covers, in the non-visible interior area, and parts which are covered in the application (e.g. drive trunnions).

Accessories

Trunnion support LNZG

Material:
Trunnion support: Anodised aluminium
Plain bearing: Plastic
RoHS-compliant

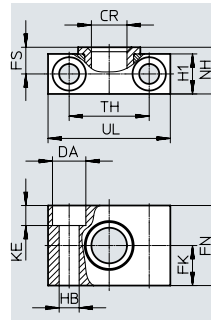
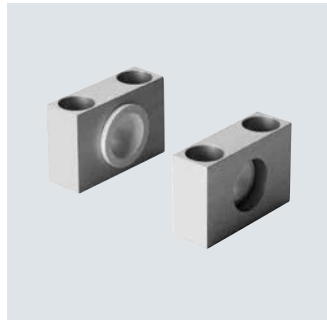

Dimensions and ordering data

For \varnothing [mm]	CR \varnothing D11	DA \varnothing H13	FK \varnothing ± 0.1	FN	FS	H1	HB \varnothing H13	KE	NH	TH ± 0.2	UL	CRC ¹⁾	Weight [g]	Part no.	Type
32	12	11	15	30	10.5	15	6.6	6.8	18	32	46	2	83	32959	LNZG-32
40, 50	16	15	18	36	12	18	9	9	21	36	55	2	129	32960	LNZG-40/50
63, 80	20	18	20	40	13	20	11	11	23	42	65	2	178	32961	LNZG-63/80
100, 125	25	20	25	50	16	24.5	14	13	28.5	50	75	2	306	32962	LNZG-100/125

1) Corrosion resistance class CRC 2 to Festo standard FN 940070

Moderate corrosion stress. Indoor applications in which condensation can occur. External visible parts with primarily decorative surface requirements which are in direct contact with a normal industrial environment.

Trunnion support CRLNZG

Material:
High-alloy steel
RoHS-compliant

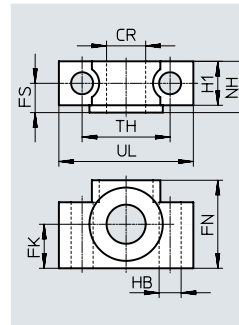
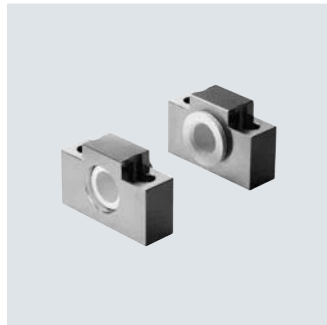

Dimensions and ordering data

For \varnothing [mm]	CR \varnothing D11	FK \varnothing ± 0.1	FN	FS	H1	HB \varnothing H13	NH	TH ± 0.2	UL	CRC ¹⁾	Weight [g]	Part no.	Type
32	12	15	30	10.5	15	6.6	18	32	46	4	205	161874	CRLNZG-32
40, 50	16	18	36	12	18	9	21	36	55	4	323	161875	CRLNZG-40/50
63, 80	20	20	40	13	20	11	23	42	65	4	435	161876	CRLNZG-63/80
100, 125	25	25	50	16	24.5	14	28.5	50	75	4	739	161877	CRLNZG-100/125

1) Corrosion resistance class CRC 4 to Festo standard FN 940070

Particularly high corrosion stress. Outdoor exposure under extreme corrosive conditions. Parts exposed to aggressive media, e.g. in the chemical or food industries. Such applications may need to be safeguarded by means of special testing (→ also FN 940082), using appropriate media.

Accessories

Swivel flange SNC

Material:
Die-cast aluminium
RoHS-compliant

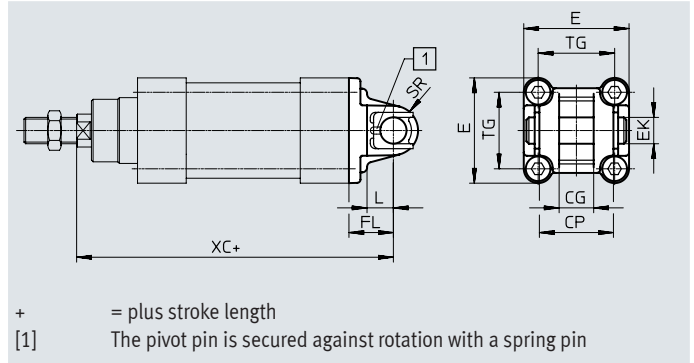
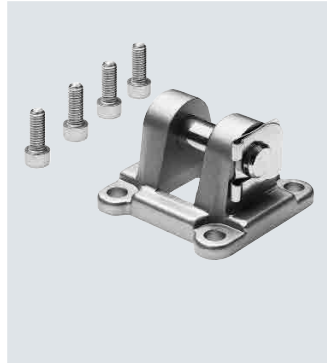

Dimensions and ordering data							
For \varnothing	CG	CP	E	EK \varnothing	FL	L	SR
[mm]	H14	h14		H9	± 0.2		
32	14	34	$45_{+0.2/-0.5}$	10	22	13	10
40	16	40	$54_{-0.5}$	12	25	16	12
50	21	45	$64_{-0.6}$	16	27	16	12
63	21	51	$75_{-0.6}$	16	32	21	16
80	25	65	$93_{-0.8}$	20	36	22	16
100	25	75	$110_{+0.3/-0.8}$	20	41	27	20
125	37	97	$131_{-0.8}$	30	50	30	25

For \varnothing	TG	XC		CRC ¹⁾	Weight	Part no.	Type
		DNC...	DNC...-KP				
[mm]					[g]		
32	32.5	142	187	1	93	174383	SNC-32
40	38	160	213	1	140	174384	SNC-40
50	46.5	170	237	1	234	174385	SNC-50
63	56.5	190	266	1	331	174386	SNC-63
80	72	210	305	1	618	174387	SNC-80
100	89	230	328	1	865	174388	SNC-100
125	110	275	400	1	1728	174389	SNC-125

1) Corrosion resistance class CRC 1 to Festo standard FN 940070

Low corrosion stress. Dry indoor application or transport and storage protection. Also applies to parts behind covers, in the non-visible interior area, and parts which are covered in the application (e.g. drive trunnions).

Accessories

Swivel flange SNCB/SNCB-...-R3

Material:
 SNCB: Die-cast aluminium
 SNCB-...-R3: Die-cast aluminium with
 protective coating
 RoHS-compliant

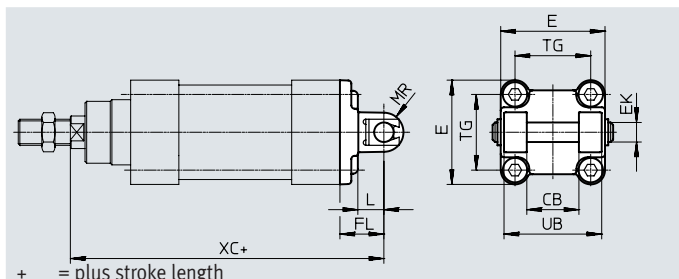
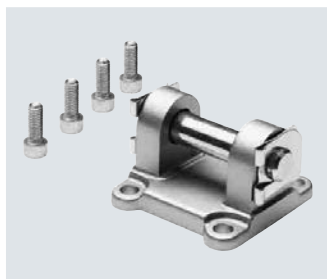

Dimensions and ordering data

For \varnothing [mm]	CB	E	EK \varnothing e8	FL ± 0.2	L	MR	TG	UB	XC	
									DNC...	DNC...-KP
32	26	45 ^{+0.2/-0.5}	10	22	13	8.5	32.5	45	142	187
40	28	54 ^{-0.5}	12	25	16	12	38	52	160	213
50	32	64 ^{-0.6}	12	27	16	12	46.5	60	170	237
63	40	75 ^{-0.6}	16	32	21	16	56.5	70	190	266
80	50	93 ^{-0.8}	16	36	22	16	72	90	210	305
100	60	110 ^{+0.3/-0.8}	20	41	27	20	89	110	230	328
125	70	131 ^{-0.8}	25	50	30	25	110	130	275	400

For \varnothing [mm]	Basic version				R3 – High corrosion protection			
	CRC ¹⁾	Weight [g]	Part no.	Type	CRC ¹⁾	Weight [g]	Part no.	Type
32	1	103	174390	SNCB-32	3	100	176944	SNCB-32-R3
40	1	155	174391	SNCB-40	3	151	176945	SNCB-40-R3
50	1	233	174392	SNCB-50	3	228	176946	SNCB-50-R3
63	1	375	174393	SNCB-63	3	371	176947	SNCB-63-R3
80	1	636	174394	SNCB-80	3	632	176948	SNCB-80-R3
100	1	1035	174395	SNCB-100	3	986	176949	SNCB-100-R3
125	1	1860	174396	SNCB-125	3	1776	176950	SNCB-125-R3

1) Corrosion resistance class CRC 1 to Festo standard FN 940070

Low corrosion stress. Dry indoor application or transport and storage protection. Also applies to parts behind covers, in the non-visible interior area, and parts which are covered in the application (e.g. drive trunnions).

Corrosion resistance class CRC 3 to Festo standard FN 940070

High corrosion stress. Outdoor exposure under moderate corrosive conditions. Externally visible parts with primarily functional surface requirements which are in direct contact with a normal industrial environment.

Accessories

Swivel flange

SNCS/CRSNCS/SNCS-...-R3

Material:

SNCS 32 ... 50:

Die-cast aluminium

SNCS 63 ... 125:

Wrought aluminium alloy

CRSNCS 32 ... 80:

High-alloy stainless steel

SNCS-...-R3 100 ... 125:

Wrought aluminium alloy with

protective coating

RoHS-compliant

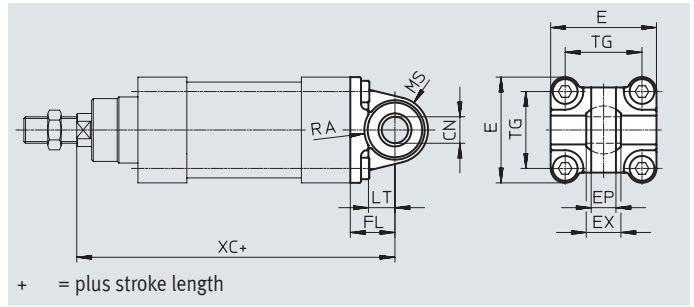
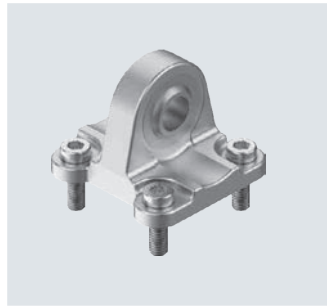

Dimensions and ordering data

For \varnothing [mm]	CN \varnothing		E		EP ± 0.2	EX	FL ± 0.2	LT
	DNC...	DNC...-R3	DNC...	DNC...-R3				
32	10 ^{+0.013}	10 ^{+0.015/-0.04}	45 ^{+0.2/-0.5}	45 ^{-0.5}	10.5	14	22	13
40	12 ^{+0.015}	12 ^{+0.018/-0.04}	54 ^{-0.5}	54 ^{-0.5}	12	16	25	16
50	16 ^{+0.015}	16 ^{+0.018/-0.04}	64 ^{-0.6}	64 ^{-0.6}	15	21	27	16
63	16 ^{+0.015}	16 ^{+0.018/-0.04}	74.5 ± 0.5	75 ^{-0.6}	15	21	32	21
80	20 ^{+0.018}	20 ^{+0.021/-0.04}	92.2 ± 0.8	93 ^{-0.8}	18	25	36	22
100	20 ^{+0.018}	20 ^{+0.021/-0.04}	109 ^{+1/-0.7}	109 ^{+1/-0.7}	18	25	41	27
125	30 ^{+0.018}	30 ^{+0.021/-0.04}	132 ^{+1/-0.7}	132 ^{+1/-0.7}	25	37	50	30

For \varnothing [mm]	MS		RA		TG	XC	
	DNC...	DNC...-R3	DNC... +1	DNC...-R3 +1		DNC...	DNC...-KP
32	15 ^{+0.5}	15 ^{+0.5}	14.5	14.5	32.5	142	187
40	17 ^{+0.5}	17 ^{+0.5}	17.5	17.5	38	160	213
50	20 ^{+0.5}	20 ^{+0.5}	18.5	19	46.5	170	237
63	23 ^{-0.5}	22 ^{+0.5}	23	23	56.5	190	266
80	28 ^{-0.5}	27 ^{+0.5}	25	25	72	210	305
100	30 ± 0.5	30 ± 0.5	95	100	89	230	328
125	39 ± 0.5	39 ± 0.5	100	100	110	275	400

For \varnothing [mm]	Basic version				High corrosion protection			
	CRC ¹⁾	Weight [g]	Part no.	Type	CRC ¹⁾	Weight [g]	Part no.	Type
32	1	86	174397	SNCS-32	4	161	2895920	CRSNCS-32
40	1	122	174398	SNCS-40	4	239	2895921	CRSNCS-40
50	1	216	174399	SNCS-50	4	403	2895922	CRSNCS-50
63	2	281	174400	SNCS-63	4	576	2895923	CRSNCS-63
80	2	557	174401	SNCS-80	4	1173	2895924	CRSNCS-80
100	2	683	174402	SNCS-100	3	684	2895925	SNCS-100-R3
125	2	1369	174403	SNCS-125	3	1369	2895926	SNCS-125-R3

1) Corrosion resistance class CRC 1 to Festo standard FN 940070

Low corrosion stress. Dry indoor application or transport and storage protection. Also applies to parts behind covers, in the non-visible interior area, and parts which are covered in the application (e.g. drive trunnions).

Corrosion resistance class CRC 2 to Festo standard FN 940070

Moderate corrosion stress. Indoor applications in which condensation can occur. External visible parts with primarily decorative surface requirements which are in direct contact with a normal industrial environment.

Corrosion resistance class CRC 3 to Festo standard FN 940070

High corrosion stress. Outdoor exposure under moderate corrosive conditions. Externally visible parts with primarily functional surface requirements which are in direct contact with a normal industrial environment.

Corrosion resistance class CRC 4 to Festo standard FN 940070

Particularly high corrosion stress. Outdoor exposure under extreme corrosive conditions. Parts exposed to aggressive media, e.g. in the chemical or food industries. Such applications may need to be safeguarded by means of special testing (→ also FN 940082), using appropriate media.

Accessories

Swivel flange SNCL

Material:
Die-cast aluminium
RoHS-compliant

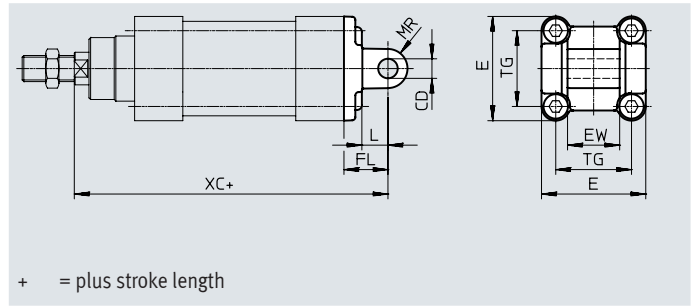

Dimensions and ordering data

For \varnothing [mm]	CD \varnothing H9	E	EW -0.2/-0.6	FL ± 0.2	L	MR
32	10	45 ^{+0.2/-0.5}	26	22	13	10
40	12	54 ^{-0.5}	28	25	16	12
50	12	64 ^{-0.6}	32	27	16	12
63	16	75 ^{-0.6}	40	32	21	16
80	16	93 ^{-0.8}	50	36	22	16
100	20	110 ^{+0.3/-0.8}	60	41	27	20
125	25	131 ^{-0.8}	70	50	30	25



For \varnothing [mm]	TG	XC		CRC ¹⁾	Weight [g]	Part no.	Type
		DNC...	DNC...-KP				
32	32.5	142	187	1	71	174404	SNCL-32
40	38	160	213	1	95	174405	SNCL-40
50	46.5	170	237	1	158	174406	SNCL-50
63	56.5	190	266	1	225	174407	SNCL-63
80	72	210	305	1	436	174408	SNCL-80
100	89	230	328	1	606	174409	SNCL-100
125	110	275	400	1	1135	174410	SNCL-125

1) Corrosion resistance class CRC 1 to Festo standard FN 940070



Low corrosion stress. Dry indoor application or transport and storage protection. Also applies to parts behind covers, in the non-visible interior area, and parts which are covered in the application (e.g. drive trunnions).

Accessories

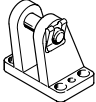
Ordering data – Mounting components

Designation	For \varnothing	Part no.	Type
Clevis foot LNG			
	32	33890	LNG-32
	40	33891	LNG-40
	50	33892	LNG-50
	63	33893	LNG-63
	80	33894	LNG-80
	100	33895	LNG-100
	125	33896	LNG-125
Clevis foot LSNG			
	32	31740	LSNG-32
	40	31741	LSNG-40
	50	31742	LSNG-50
	63	31743	LSNG-63
	80	31744	LSNG-80
	100	31745	LSNG-100
	125	31746	LSNG-125
Clevis foot LBG			
	32	31761	LBG-32
	40	31762	LBG-40
	50	31763	LBG-50
	63	31764	LBG-63
	80	31765	LBG-80
	100	31766	LBG-100
	125	31767	LBG-125

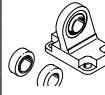
Ordering data – Mounting components

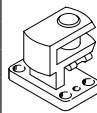
Designation	For \varnothing	Part no.	Type
Clevis foot LSN			
	32	5561	LSN-32
	40	5562	LSN-40
	50	5563	LSN-50
	63	5564	LSN-63
	80	5565	LSN-80
	100	5566	LSN-100
	125	6987	LSN-125
Clevis foot LSNSG			
	32	31747	LSNSG-32
	40	31748	LSNSG-40
	50	31749	LSNSG-50
	63	31750	LSNSG-63
	80	31751	LSNSG-80
	100	31752	LSNSG-100
	125	31753	LSNSG-125
Right angle clevis foot LQG			
	32	31768	LQG-32
	40	31769	LQG-40
	50	31770	LQG-50
	63	31771	LQG-63
	80	31772	LQG-80
	100	31773	LQG-100
	125	31774	LQG-125

Data sheets → Internet: clevis foot

Ordering data – Mounting components, corrosion-resistant

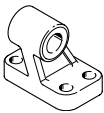
Designation	For \varnothing	Part no.	Type
Clevis foot CRLNG			
	32	161840	CRLNG-32
	40	161841	CRLNG-40
	50	161842	CRLNG-50
	63	161843	CRLNG-63
	80	161844	CRLNG-80
	100	161845	CRLNG-100
	125	176951	CRLNG-125

Data sheets → Internet: crlng

Ordering data – Mounting components, high corrosion protection

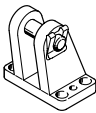
Designation	For \varnothing	Part no.	Type
Clevis foot LBG-R3			
	32	2078790	LBG-32-R3
	40	2078792	LBG-40-R3
	50	2078794	LBG-50-R3
	63	2078795	LBG-63-R3
	80	2078797	LBG-80-R3
	100	2078799	LBG-100-R3
	125	2078837	LBG-125-R3

Data sheets → Internet: clevis foot

Accessories

Ordering data – Piston rod attachments

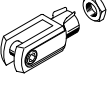
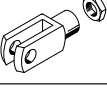
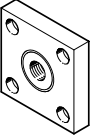
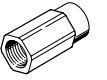
Designation	For ø	Part no.	Type
Rod eye SGS			
	32	9261	SGS-M10x1.25
	40	9262	SGS-M12x1.25
	50	9263	SGS-M16x1.5
	63		
	80	9264	SGS-M20x1.5
	100	10774	SGS-M27x2
	125		
Rod clevis SG			
	32	6144	SG-M10x1.25
	40	6145	SG-M12x1.25
	50	6146	SG-M16x1.5
	63		
	80	6147	SG-M20x1.5
	100	14987	SG-M27x2-B
	125		
Coupling piece KSG			
	32	32963	KSG-M10x1.25
	40	32964	KSG-M12x1.25
	50	32965	KSG-M16x1.5
	63		
	80	32966	KSG-M20x1.5
	100	32967	KSG-M27x2
	125		
Adapter AD			
	32	157333	AD-M10x1.25-1/8
		157334	AD-M10x1.25-1/4
	40	160256	AD-M12x1.25-1/4
		160257	AD-M12x1.25-3/8

Data sheets → Internet: piston rod attachment

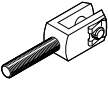
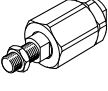
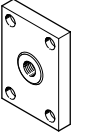
Designation	For ø	Part no.	Type
Rod clevis SGA			
	32	32954	SGA-M10x1.25
	40	10767	SGA-M12x1.25
	50	10768	SGA-M16x1.5
	63		
	80	10769	SGA-M20x1.5
	100	10770	SGA-M27x2
	125		
Self-aligning rod coupler FK			
	32	6140	FK-M10x1.25
	40	6141	FK-M12x1.25
	50	6142	FK-M16x1.5
	63		
	80	6143	FK-M20x1.5
	100	10485	FK-M27x2
	125		
Coupling piece KSZ			
	32	36125	KSZ-M10x1.25
	40	36126	KSZ-M12x1.25
	50	36127	KSZ-M16x1.5
	63		
	80	36128	KSZ-M20x1.5
	100	-	-
	125		

Ordering data – Piston-rod attachments, corrosion-resistant

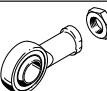
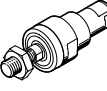
Designation	For ø	Part no.	Type
Rod eye CRSGS			
	32	195582	CRSGS-M10x1.25
	40	195583	CRSGS-M12x1.25
	50	195584	CRSGS-M16x1.5
	63		
	80	195585	CRSGS-M20x1.5
	100	195586	CRSGS-M27x2
	125		
Self-aligning rod coupler CRFK			
	32	2305778	CRFK-M10x1.25
	40	2305779	CRFK-M12x1.25
	50	2490673	CRFK-M16x1.5
	63		
	80	2545677	CRFK-M20x1.5
	100		
	125		

Data sheets → Internet: piston rod attachment

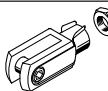
Designation	For ø	Part no.	Type
Rod clevis CRSG			
	32	13569	CRSG-M10x1.25
	40	13570	CRSG-M12x1.25
	50	13571	CRSG-M16x1.5
	63		
	80	13572	CRSG-M20x1.5
	100	185361	CRSG-M27x2
	125		

Accessories

Bellows kit DADB



General technical data		32	40	50	63	80	100
Type DADB-V6-		32	40	50	63	80	100
Max. stroke range of the cylinder ¹⁾	[mm]	10 ... 500	10 ... 500	10 ... 500	10 ... 500	10 ... 500	10 ... 500
Type of mounting		Via threaded pin					
Mounting position		Any					
Media resistance		Dust, chippings, oil, grease, fuel (→ Internet: media resistance)					
Ambient temperature ²⁾	[°C]	-10 ... +80					
Degree of protection		IP54					
Corrosion resistance class CRC ³⁾		3					

1) In combination with bellows kit DADB

2) Note operating range of proximity switches and cylinder

3) Corrosion resistance class 3 according to Festo standard 940070

Components subject to high corrosion stress. External visible parts with primarily functional surface requirements which are in direct contact with a normal industrial environment or media such as solvents and cleaning agents.

Materials

Sectional view

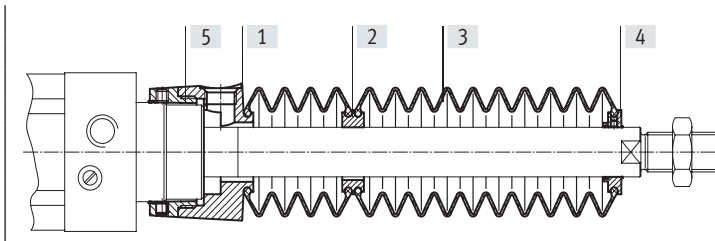

Bellows

[1]	Connection	Polyamide
[2]	Adapter	Polyamide
[3]	Bellows	NBR
[4]	End piece	Polyamide
[5]	Connector	Polyamide
-	O-ring	NBR
	Note on materials	RoHS-compliant

Weight [g]		32	40	50	63	80	100
Type DADB-V6-		32	40	50	63	80	100
Stroke [mm]							
10 ... 50		29	42	71	69	99	124
51 ... 125		41	56	91	89	127	152
126 ... 175		52	68	105	103	140	165
176 ... 250		66	85	129	127	193	218
251 ... 300		79	100	147	145	231	255
301 ... 350		92	115	166	164	268	293
351 ... 375		92	115	167	165	259	284
376 ... 425		104	129	185	183	296	321
426 ... 475		117	144	204	202	334	359
476 ... 500		117	144	205	203	324	349

Accessories

Travel speed v as a function of tubing length l



The bellows kit is a leak-free system. To prevent unwanted media from being drawn in, the supply and exhaust air must be ducted via a pressure compensation hole in the connection part [1].

The pressure generated in the bellows kit by the positioning motion is primarily defined by the travel speed and tubing length.

The recommended tubing length based on the travel speed of the drive can be read from the graph.

Advancing

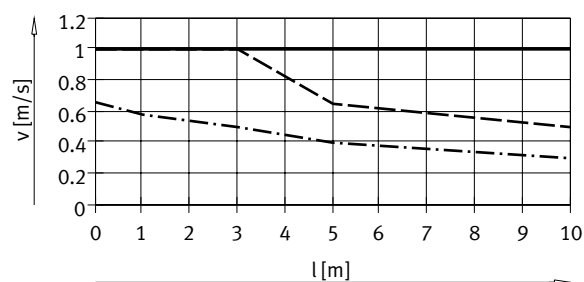

— \varnothing 32/50/63
 - · - · \varnothing 40
 - - - \varnothing 80/100

Retracting

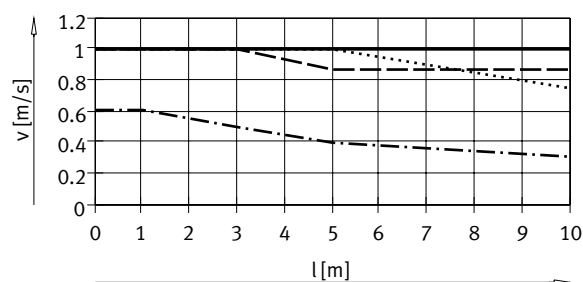

— \varnothing 32
 - · - · \varnothing 40
 - - - \varnothing 50/63
 ······ \varnothing 80/100

Note

The push-in fittings in the adjacent table must be used for the pressure compensation hole. Silencers can be used as an alternative. This reduces the travel speed slightly.

Tubing size and push-in fitting for pressure compensation hole

\varnothing [mm]	Tubing O.D. [mm]	Push-in fitting	
		Part no.	Type
32, 40	8	★ 186109	QS-G1/8-8-I
		578376	NPQH-DK-G18-Q8-P10
		578362	NPQH-D-G18-S8-P10
50, 63, 80, 100	12	★ 186350	QS-G1/4-12
		578344	NPQH-D-G14-Q12-P10
		578366	NPQH-D-G14-S12-P10

Accessories

Dimensions

Download CAD data → www.festo.com

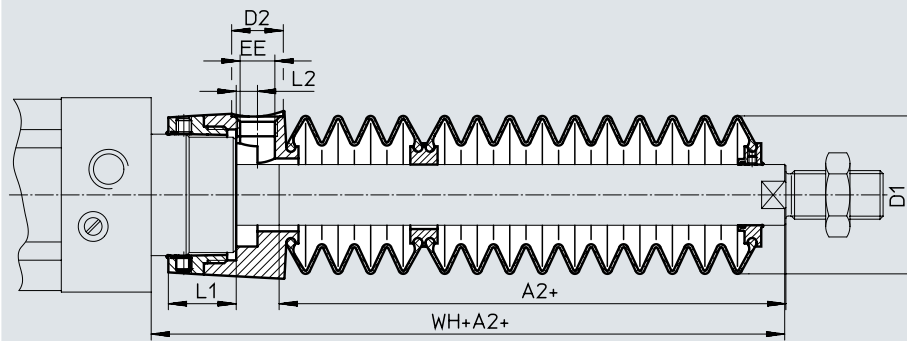

+ = plus stroke length

∅ Stroke [mm]	32							40						
	A2 ¹⁾	D1 max.	D2	EE	L1	L2	WH+A2	A2 ¹⁾	D1 max.	D2	EE	L1	L2	WH+A2
10 ... 50	29	38	14	G1/8	12.9	5.4	55	28	46	14	G1/8	16.3	5.4	58
51 ... 125	47						73	43						73
126 ... 175	61						87	56						86
176 ... 250	80						106	72						102
251 ... 300	96						122	86						116
301 ... 350	112						138	100						130
351 ... 375	114						140	101						131
376 ... 425	130						156	115						145
426 ... 475	145						171	130						160
476 ... 500	147	173	131	161										

∅ Stroke [mm]	50							63						
	A2 ¹⁾	D1 max.	D2	EE	L1	L2	WH+A2	A2 ¹⁾	D1 max.	D2	EE	L1	L2	WH+A2
10 ... 50	28	57	17	G1/4	22.35	7	65	28	57	17	G1/4	22.4	7	65
51 ... 125	46						83	46						83
126 ... 175	56						93	56						93
176 ... 250	73						110	73						110
251 ... 300	86						123	86						123
301 ... 350	97						134	97						134
351 ... 375	105						142	105						142
376 ... 425	116						153	116						153
426 ... 475	126						163	126						163
476 ... 500	134	171	134	171										

∅ Stroke [mm]	80							100						
	A2 ¹⁾	D1 max.	D2	EE	L1	L2	WH+A2	A2 ¹⁾	D1 max.	D2	EE	L1	L2	WH+A2
10 ... 50	25	93	17	G1/4	28	4	71	25	93	17	G1/4	28	4	71
51 ... 125	37						83	37						83
126 ... 175	49						95	49						95
176 ... 250	62						108	62						108
251 ... 300	74						120	74						120
301 ... 350	86						132	86						132
351 ... 375	87						133	87						133
376 ... 425	98						144	98						144
426 ... 475	110						156	110						156
476 ... 500	111	157	111	157										

1) The dimension corresponds to the K8 value (advanced piston rod) of the drive

Accessories

Ordering data – Bellows kit

An extended piston rod (order code K8) is absolutely essential when using a bellows kit → Ordering data – Modular product system.

The necessary dimension for K8 as a function of piston diameter and cylinder stroke as well as the corresponding bellows kit is indicated in the table below:

Order example:

Selected standards-based cylinder:

DNC-32-320-PPV-A...

The dimension for the corresponding K8 value (see table):
112 mm

Complete order reference for standards-based cylinder:

DNC-32-320-PPV-A...-112K8

The corresponding bellows kit:

DADB-V6-32-S301-350

Cylinder data			Bellows kit		Cylinder data			Bellows kit	
∅	Stroke	Dimension for K8	Part no.	Type	∅	Stroke	Dimension for K8	Part no.	Type
[mm]	[mm]	[mm]			[mm]	[mm]	[mm]		
32	10 ... 50	29	553271	DADB-V6-32-S10-50	40	10 ... 50	28	553291	DADB-V6-40-S10-50
	51 ... 125	47	553273	DADB-V6-32-S51-125		51 ... 125	43	553293	DADB-V6-40-S51-125
	126 ... 175	61	553275	DADB-V6-32-S126-175		126 ... 175	56	553295	DADB-V6-40-S126-175
	176 ... 250	80	553277	DADB-V6-32-S176-250		176 ... 250	72	553297	DADB-V6-40-S176-250
	251 ... 300	96	553279	DADB-V6-32-S251-300		251 ... 300	86	553399	DADB-V6-40-S251-300
	301 ... 350	112	553281	DADB-V6-32-S301-350		301 ... 350	100	553301	DADB-V6-40-S301-350
	351 ... 375	114	553283	DADB-V6-32-S351-375		351 ... 375	101	553303	DADB-V6-40-S351-375
	376 ... 425	130	553285	DADB-V6-32-S376-425		376 ... 425	115	553305	DADB-V6-40-S376-425
	426 ... 475	145	553287	DADB-V6-32-S426-475		426 ... 475	130	553307	DADB-V6-40-S426-475
476 ... 500	147	553289	DADB-V6-32-S476-500	476 ... 500	131	553309	DADB-V6-40-S476-500		
50	10 ... 50	28	553311	DADB-V6-50-S10-50	63	10 ... 50	28	553331	DADB-V6-63-S10-50
	51 ... 125	46	553313	DADB-V6-50-S51-125		51 ... 125	46	553333	DADB-V6-63-S51-125
	126 ... 175	56	553315	DADB-V6-50-S126-175		126 ... 175	56	553335	DADB-V6-63-S126-175
	176 ... 250	73	553317	DADB-V6-50-S176-250		176 ... 250	73	553337	DADB-V6-63-S176-250
	251 ... 300	86	553319	DADB-V6-50-S251-300		251 ... 300	86	553339	DADB-V6-63-S251-300
	301 ... 350	97	553321	DADB-V6-50-S301-350		301 ... 350	97	553341	DADB-V6-63-S301-350
	351 ... 375	105	553323	DADB-V6-50-S351-375		351 ... 375	105	553343	DADB-V6-63-S351-375
	376 ... 425	116	553325	DADB-V6-50-S376-425		376 ... 425	116	553345	DADB-V6-63-S376-425
	426 ... 475	126	553327	DADB-V6-50-S426-475		426 ... 475	126	553347	DADB-V6-63-S426-475
476 ... 500	134	553329	DADB-V6-50-S476-500	476 ... 500	134	553349	DADB-V6-63-S476-500		
80	10 ... 50	25	553351	DADB-V6-80-S10-50	100	10 ... 50	25	553371	DADB-V6-100-S10-50
	51 ... 125	37	553353	DADB-V6-80-S51-125		51 ... 125	37	553373	DADB-V6-100-S51-125
	126 ... 175	49	553355	DADB-V6-80-S126-175		126 ... 175	49	553375	DADB-V6-100-S126-175
	176 ... 250	62	553357	DADB-V6-80-S176-250		176 ... 250	62	553377	DADB-V6-100-S176-250
	251 ... 300	74	553359	DADB-V6-80-S251-300		251 ... 300	74	553379	DADB-V6-100-S251-300
	301 ... 350	86	553361	DADB-V6-80-S301-350		301 ... 350	86	553381	DADB-V6-100-S301-350
	351 ... 375	87	553363	DADB-V6-80-S351-375		351 ... 375	87	553383	DADB-V6-100-S351-375
	376 ... 425	98	553365	DADB-V6-80-S376-425		376 ... 425	98	553385	DADB-V6-100-S376-425
	426 ... 475	110	553367	DADB-V6-80-S426-475		426 ... 475	110	553387	DADB-V6-100-S426-475
476 ... 500	111	553369	DADB-V6-80-S476-500	476 ... 500	111	553389	DADB-V6-100-S476-500		

Accessories

Ordering data – Guide units for fixed strokes (recirculating ball bearing guide only)

Data sheets → Internet: feng

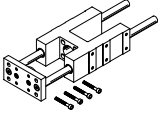
	Stroke [mm]	Part no.	Type	Stroke [mm]	Part no.	Type
	For \varnothing 32 mm			For \varnothing 40 mm		
	10 ... 50	34493	FENG-32-50-KF	10 ... 50	34499	FENG-40-50-KF
	10 ... 100	34494	FENG-32-100-KF	10 ... 100	34500	FENG-40-100-KF
	10 ... 160	34495	FENG-32-160-KF	10 ... 160	34501	FENG-40-160-KF
	10 ... 200	34496	FENG-32-200-KF	10 ... 200	34502	FENG-40-200-KF
	10 ... 250	150289	FENG-32-250-KF	10 ... 250	34503	FENG-40-250-KF
	10 ... 320	34497	FENG-32-320-KF	10 ... 320	34504	FENG-40-320-KF
	10 ... 400	150290	FENG-32-400-KF	10 ... 400	150291	FENG-40-400-KF
	10 ... 500	34498	FENG-32-500-KF	10 ... 500	34505	FENG-40-500-KF
	For \varnothing 50 mm			For \varnothing 63 mm		
	10 ... 50	34506	FENG-50-50-KF	10 ... 50	34513	FENG-63-50-KF
	10 ... 100	34507	FENG-50-100-KF	10 ... 100	34514	FENG-63-100-KF
	10 ... 160	34508	FENG-50-160-KF	10 ... 160	34515	FENG-63-160-KF
	10 ... 200	34509	FENG-50-200-KF	10 ... 200	34516	FENG-63-200-KF
	10 ... 250	34510	FENG-50-250-KF	10 ... 250	34517	FENG-63-250-KF
	10 ... 320	34511	FENG-50-320-KF	10 ... 320	34518	FENG-63-320-KF
	10 ... 400	150292	FENG-50-400-KF	10 ... 400	34519	FENG-63-400-KF
	10 ... 500	34512	FENG-50-500-KF	10 ... 500	34520	FENG-63-500-KF
	For \varnothing 80 mm			For \varnothing 100 mm		
	10 ... 50	34521	FENG-80-50-KF	10 ... 50	34529	FENG-100-50-KF
	10 ... 100	34522	FENG-80-100-KF	10 ... 100	34530	FENG-100-100-KF
	10 ... 160	34523	FENG-80-160-KF	10 ... 160	34531	FENG-100-160-KF
	10 ... 200	34524	FENG-80-200-KF	10 ... 200	34532	FENG-100-200-KF
	10 ... 250	34525	FENG-80-250-KF	10 ... 250	34533	FENG-100-250-KF
	10 ... 320	34526	FENG-80-320-KF	10 ... 320	34534	FENG-100-320-KF
	10 ... 400	34527	FENG-80-400-KF	10 ... 400	34535	FENG-100-400-KF
	10 ... 500	34528	FENG-80-500-KF	10 ... 500	34536	FENG-100-500-KF

Ordering data – Guide units for variable strokes

Data sheets → Internet: feng

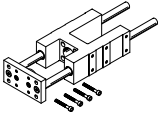

	For \varnothing [mm]	Stroke [mm]	With recirculating ball bearing guide		With plain-bearing guide	
			Part no.	Type	Part no.	Type
	32	10 ... 500	34487	FENG-32-...-KF	34481	FENG-32-...-GF
	40	10 ... 500	34488	FENG-40-...-KF	34482	FENG-40-...-GF
	50	10 ... 500	34489	FENG-50-...-KF	34483	FENG-50-...-GF
	63	10 ... 500	34490	FENG-63-...-KF	34484	FENG-63-...-GF
	80	10 ... 500	34491	FENG-80-...-KF	34485	FENG-80-...-GF
	100	10 ... 500	34492	FENG-100-...-KF	34486	FENG-100-...-GF

Ordering data – Mounting kits for proximity switch SMT-8

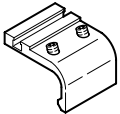
Data sheets → Internet: smb

	For \varnothing [mm]	Part no.	Type
	32	175705	SMB-8-FENG-32/40
	40		
	50	175706	SMB-8-FENG-50/63
	63		
	80	175707	SMB-8-FENG-80/100
	100		

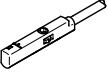
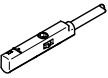
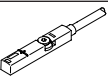
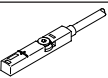
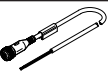
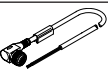
Accessories

Ordering data – Proximity switch for T-slot, magneto-resistive						Data sheets → Internet: smt
	Type of mounting	Switching output	Electrical connection	Cable length [m]	Part no.	Type
N/O contact						
	Inserted in the slot from above, flush with the cylinder profile, short design	PNP	Cable, 3-wire	2.5	574335	SMT-8M-A-PS-24V-E-2.5-OE
			Plug M8x1, 3-pin	0.3	574334	SMT-8M-A-PS-24V-E-0.3-M8D
			Plug M12x1, 3-pin	0.3	574337	SMT-8M-A-PS-24V-E-0.3-M12
		NPN	Cable, 3-wire	2.5	574338	SMT-8M-A-NS-24V-E-2.5-OE
			Plug M8x1, 3-pin	0.3	574339	SMT-8M-A-NS-24V-E-0.3-M8D
N/C contact						
	Inserted in the slot from above, flush with the cylinder profile, short design	PNP	Cable, 3-wire	7.5	574340	SMT-8M-A-PO-24V-E-7.5-OE
Ordering data – Proximity switch for T-slot, magnetic reed						Data sheets → Internet: sme
	Type of mounting	Switching output	Electrical connection	Cable length [m]	Part no.	Type
N/O contact						
	Inserted in the slot from above, flush with the cylinder profile	Contacting	Cable, 3-wire	2.5	543862	SME-8M-DS-24V-K-2.5-OE
				5.0	543863	SME-8M-DS-24V-K-5.0-OE
			Cable, 2-wire	2.5	543872	SME-8M-ZS-24V-K-2.5-OE
			Plug M8x1, 3-pin	0.3	543861	SME-8M-DS-24V-K-0.3-M8D
	Inserted in the slot lengthwise, flush with the cylinder profile	Contacting	Cable, 3-wire	2.5	150855	SME-8-K-LED-24
			Plug M8x1, 3-pin	0.3	150857	SME-8-S-LED-24
N/C contact						
	Inserted in the slot lengthwise, flush with the cylinder profile	Contacting	Cable, 3-wire	7.5	160251	SME-8-O-K-LED-24
Ordering data – Connecting cables						Data sheets → Internet: nebu
	Electrical connection, left	Electrical connection, right	Cable length [m]	Part no.	Type	
	Straight socket, M8x1, 3-pin	Cable, open end, 3-wire	2.5	541333	NEBU-M8G3-K-2.5-LE3	
			5	541334	NEBU-M8G3-K-5-LE3	
	Straight socket, M12x1, 5-pin	Cable, open end, 3-wire	2.5	541363	NEBU-M12G5-K-2.5-LE3	
			5	541364	NEBU-M12G5-K-5-LE3	
	Angled socket, M8x1, 3-pin	Cable, open end, 3-wire	2.5	541338	NEBU-M8W3-K-2.5-LE3	
			5	541341	NEBU-M8W3-K-5-LE3	
	Angled socket, M12x1, 5-pin	Cable, open end, 3-wire	2.5	541367	NEBU-M12W5-K-2.5-LE3	
			5	541370	NEBU-M12W5-K-5-LE3	
Ordering data – Slot cover for T-slot						
	Mounting	Length	Part no.	Type		
	Insertable	2x 0.5 m	151680	ABP-5-S		

Accessories

Ordering data – One-way flow control valves				Data sheets → Internet: grla	
	Connection	For tubing O.D.	Material	Part no.	Type
	Thread				
	G1/8	3	Metal design	193142	GRLA-1/8-QS-3-D
		4		193143	GRLA-1/8-QS-4-D
		6		193144	GRLA-1/8-QS-6-D
		8		193145	GRLA-1/8-QS-8-D
	G1/4	6		193146	GRLA-1/4-QS-6-D
		8		193147	GRLA-1/4-QS-8-D
		10		193148	GRLA-1/4-QS-10-D
	G3/8	6		193149	GRLA-3/8-QS-6-D
		8		193150	GRLA-3/8-QS-8-D
		10		193151	GRLA-3/8-QS-10-D
	G1/2	12		193152	GRLA-1/2-QS-12-D

Festo - Your Partner in Automation



1 Festo Inc.
5300 Explorer Drive
Mississauga, ON L4W 5G4
Canada

Festo Customer Interaction Center
Tel: 1 877 463 3786
Fax: 1 877 393 3786
Email: customer.service.ca@festo.com



2 Festo Pneumatic
Av. Ceylán 3,
Col. Tequesquináhuac
54020 Tlalneantla,
Estado de México

Multinational Contact Center
01 800 337 8669
ventas.mexico@festo.com



3 Festo Corporation
1377 Motor Parkway
Suite 310
Islandia, NY 11749

Festo Customer Interaction Center
1 800 993 3786
1 800 963 3786
customer.service.us@festo.com



4 Regional Service Center
7777 Columbia Road
Mason, OH 45040

Connect with us



www.festo.com/socialmedia



www.festo.com

Subject to change