

Guided cylinders DFP



Guided cylinders DFP

Features

FESTO

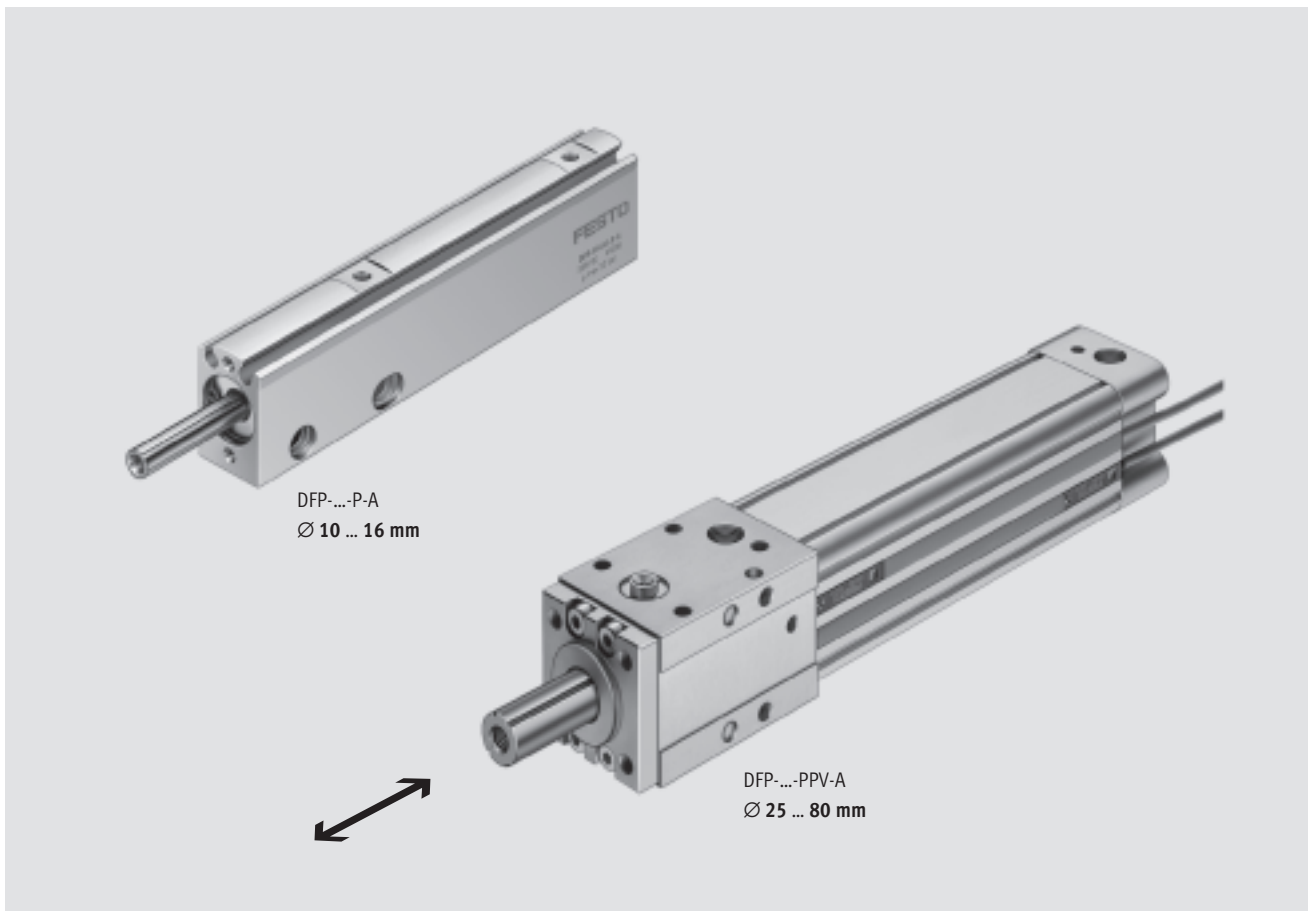

Brief description

- Double-acting
- High-precision guidance thanks to recirculating ball bearing guide
- Able to absorb high torques
- Saves space in comparison with standard cylinders with external guide unit
- Flexible cushioning rings/plates at both ends for Ø 10 ... 16 mm
- Pneumatic cushioning adjustable at both ends for Ø 25 ... 80 mm
- For contactless position sensing

Guided cylinders DFP

Features

FESTO

Less installation space required

Standard cylinder with guide unit

Guided cylinder DFP

High precision

Grooved piston rod with recirculating ball bearing guide

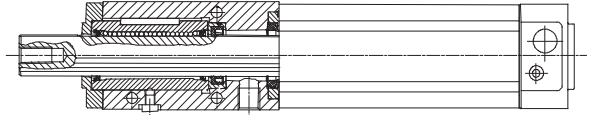
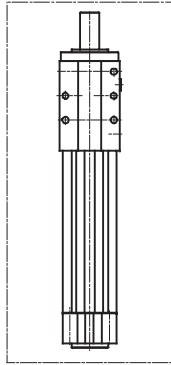
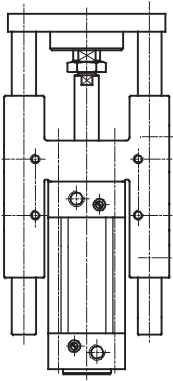

Mounting options

Via female thread

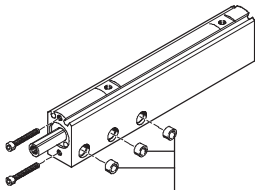

Centring sleeves
(both sides,
max. 2 pieces)

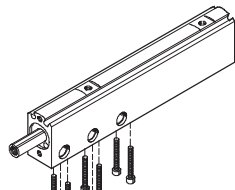

Centring sleeves
(one side only)
Mounting screws
(max. 6 pieces)

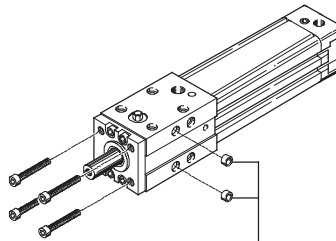

Centring sleeves
(both sides)

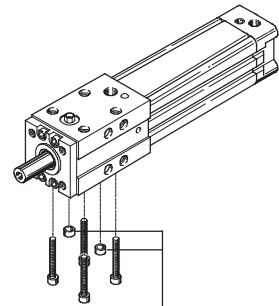

Centring sleeves
(one side only)

Via through-holes

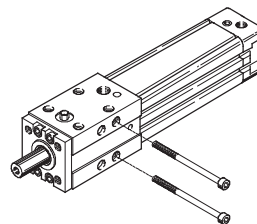
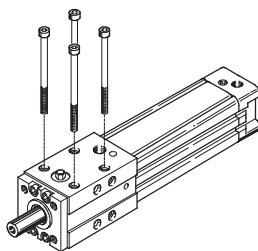
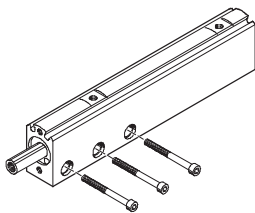

Guided cylinders DFP

Peripherals overview

FESTO

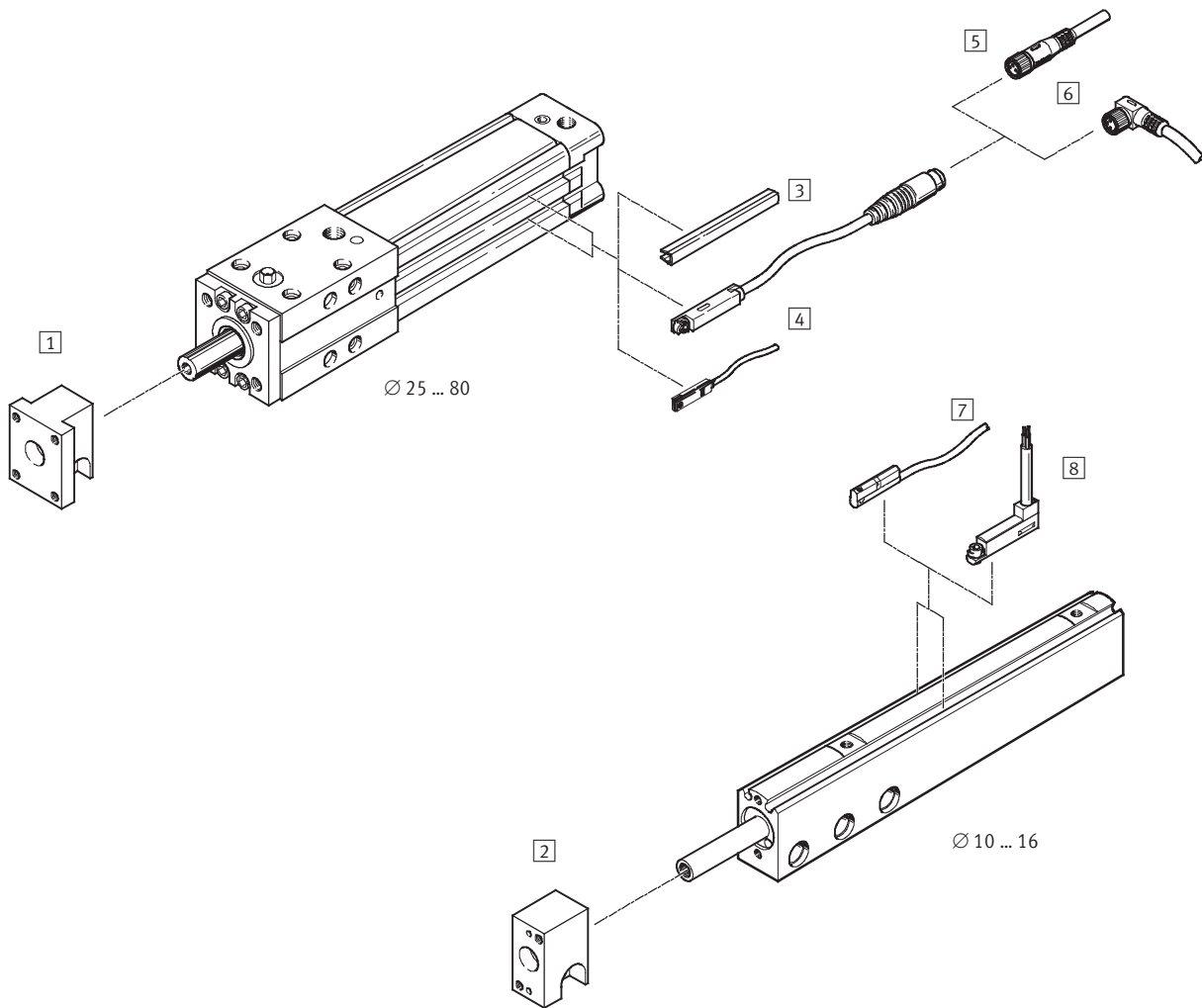

Accessories		Brief description	Piston Ø [mm]		→ Page/Internet
			10 ... 16	25 ... 32	
1	Push-on flange FFP	For piston Ø 25 ... 32 mm	-	■	16
2	Push-on flange FFP	For piston Ø 10 ... 16 mm	■	-	16
3	Slot cover ABP-5-S	To protect the sensor cable and keep dirt out of the sensor slots	-	■	18
4	Proximity sensors SME/SMT-8	Can be integrated in the cylinder profile barrel	-	■	18
5	Connecting cable, straight NEBU	-	-	■	18
6	Connecting cable, angled NEBU	-	-	■	18
7	Proximity sensors SME/SMT-10	Can be integrated in the cylinder profile barrel	■	-	17
8	Proximity sensors SME/SMT-10F	Can be integrated in the cylinder profile barrel	■	-	17
-	Centring pins/sleeves ZBH	-	■	■	17

Guided cylinders DFP

Type codes

		DFP	-	50	-	80	-	PPV	-	A	-	S2
Type												
Double-acting												
DFP	Guided cylinder											
Piston Ø [mm]												
Stroke [mm]												
Cushioning												
P	Flexible cushioning rings/plates at both ends											
PPV	Pneumatic cushioning adjustable at both ends											
Sensing												
A	For proximity sensing											
Variant												
S2	Through piston rod											

Guided cylinders DFP

Technical data

FESTO

Function

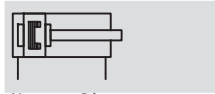

-N- Diameter
10 ... 16 mm
-T- Stroke length
25 ... 100 mm

www.festo.com/en/Spare_parts_service

Variant



S2



DFP-...-P-A

Function

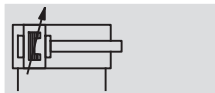

-N- Diameter
25 ... 80 mm
-T- Stroke length
25 ... 500 mm

www.festo.com/en/Spare_parts_service

Variant



S2

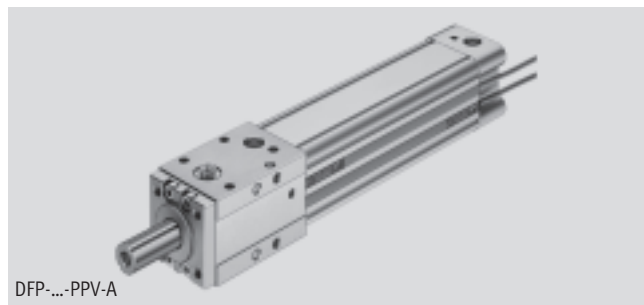

DFP-...-PPV-A

General technical data						
Piston Ø	10	16	25	32	50	80
Pneumatic connection	M3	M5	G1/8	G1/8	G1/4	G3/8
Operating medium	Compressed air in accordance with ISO 8573-1:2010 [7:4:4]					
Note on operating/pilot medium	Operation with lubricated medium possible (in which case lubricated operation will always be required)					
Guide	Via ball bearings					
Cushioning	Flexible cushioning rings/plates at both ends		Adjustable at both ends			
Cushioning length [mm]	-	-	17	20	22	32
Position sensing	For proximity sensing					
Type of mounting	Via female threads Using through holes					
Mounting position	Any					

Operating and environmental conditions	
Operating pressure [bar]	0.5 ... 10
Ambient temperature ¹⁾ [°C]	-10 ... +60

1) Note operating range of proximity sensors

Forces [N] and impact energy [Nm]						
Piston Ø	10	16	25	32	50	80
Theoretical force at 6 bar, advancing ¹⁾	47	121	295	483	1,178	3,016
Theoretical force at 6 bar, retracting	31	91	217	364	884	2,262
Max. impact energy at the end positions	0.05	0.07	0.2	0.35	0.6	1.6

1) The force in the advance stroke is the same as the force in the return stroke with the variant S2.

Guided cylinders DFP

Technical data

FESTO

Speed [m/s]							
Piston Ø		10	16	25	32	50	80
Maximum speed advancing	$v_{\max A}$	0.8	0.8	1.5	1.5	1	0.9
Maximum speed retracting	$v_{\max L}$	0.8	0.8	1.5	1.5	1	0.7

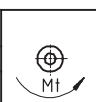
Max. torque ¹⁾ [Nm]							
Piston Ø		10	16	25	32	50	80
	dynamic	0.2	0.4	1.1	5.8	19	75
	static	0.4	0.6	2.7	8.5	25	100

1) Torque at piston rod

Weights [g]													
Stroke [mm]	Piston Ø												
	10		16		25		32		50		80		
	Basic version	S2	Basic version	S2	Basic version	S2	Basic version	S2	Basic version	S2	Basic version	S2	
25	118	124	180	195	590	652	–	–	–	–	–	–	
50	147	156	218	238	660	737	1,180	1,297	2,960	3,351	8,077	8,814	
80	173	185	263	290	740	836	1,295	1,439	3,150	3,570	8,561	9,414	
100	198	212	293	325	794	902	1,357	1,519	3,340	3,855	8,856	9,787	
160	–	–	–	–	957	1,102	1,590	1,805	3,804	4,468	9,786	10,949	
200	–	–	–	–	–	–	1,732	1,983	4,100	4,863	10,460	11,778	
250	–	–	–	–	–	–	1,914	2,210	4,490	5,377	11,289	12,801	
320	–	–	–	–	–	–	–	–	5,030	6,091	12,436	14,220	
400	–	–	–	–	–	–	–	–	5,610	6,869	13,750	15,844	
500	–	–	–	–	–	–	–	–	–	–	15,442	17,924	

Materials

Sectional view

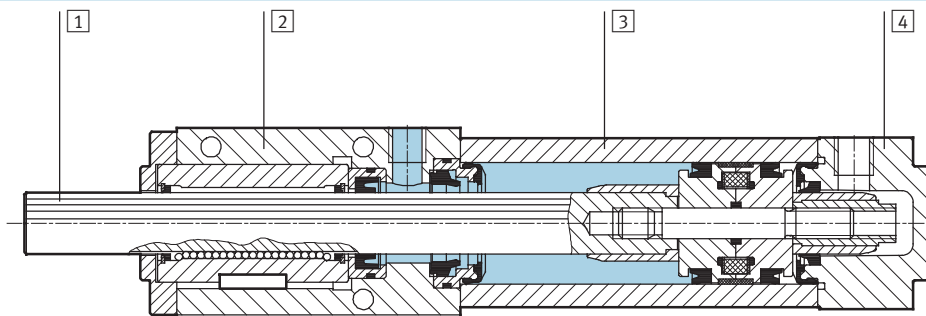

Guided cylinder		
1	Piston rod	Tempered steel
2	Bearing end cap	Aluminium
3	Cylinder barrel	Anodised aluminium
4	End cap	Aluminium
–	Seals	Polyurethane, polyacetal, nitrile rubber
Note on material		Free of copper, PTFE and silicone

Guided cylinders DFP

Technical data

FESTO

Max. permissible dynamic lateral force F_q at the piston rod

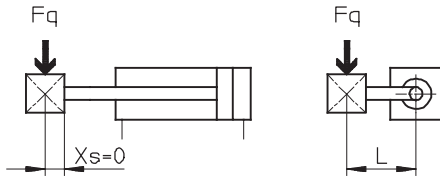

Calculation of the max. permissible dynamic lateral force F_q

$$F_q = \frac{A}{(B + X_s + H) \times K + 1 + C \times L}$$

F_q = Permissible lateral force [N] H = Stroke [mm]
 A = Equivalent bearing load [N] L = Lever arm [mm]
 B = Constant [mm] K = Constant [1/mm]
 C = Constant [1/mm] X_s = Distance from centre of mass [mm]

Calculation parameters

	Piston \varnothing [mm]					
	10	16	25	32	50	80
A	220	274	725	1,460	2,430	5,620
B	37.5	37.5	48	57	75.5	96
C	0.84	0.51	0.4	0.22	0.14	0.09
K	0.47	0.47	0.3	0.19	0.13	0.088

Max. permissible dynamic lateral force F_q at the piston rod as a function of the lever arm L

Distance from the centre of mass $X_s = 0$ mm

F_q with 25 mm stroke

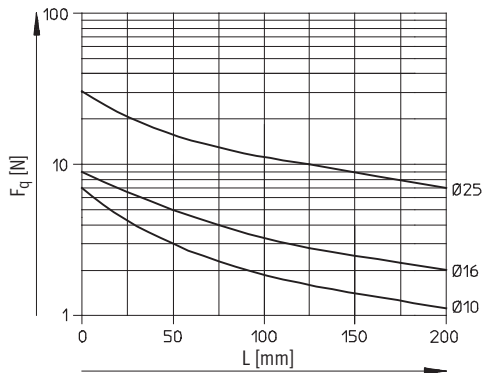

F_q with 50 mm stroke

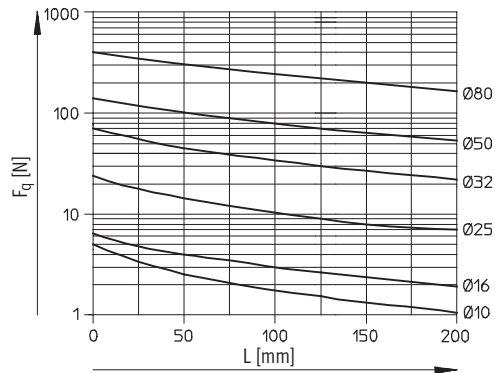

F_q with 80 mm stroke

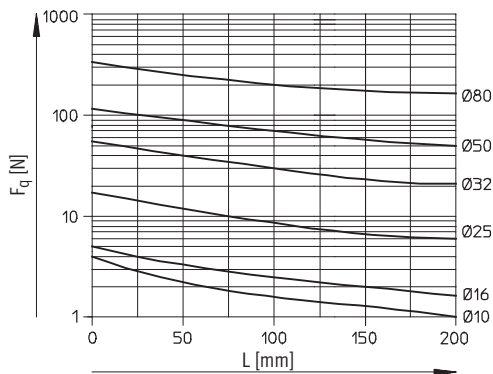

F_q with 100 mm stroke

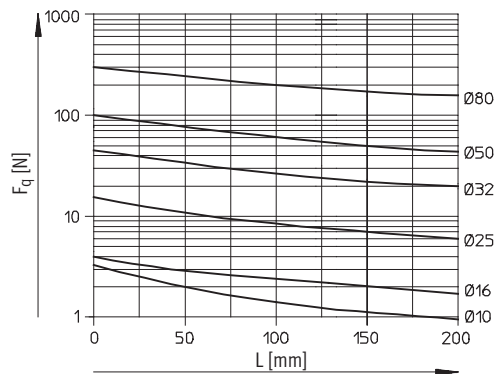

Guided cylinders DFP

Technical data

Max. permissible dynamic lateral force F_q at the piston rod as a function of the lever arm L

Distance from the centre of mass $X_s = 0$ mm

F_q with 160 mm stroke

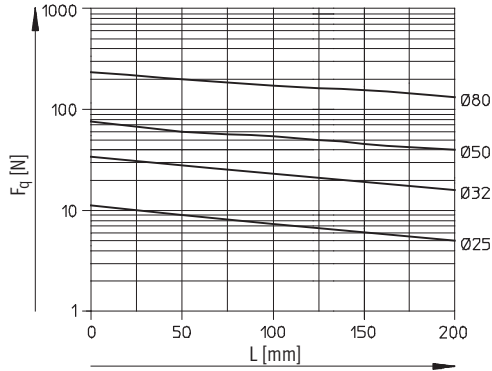

F_q with 200 mm stroke

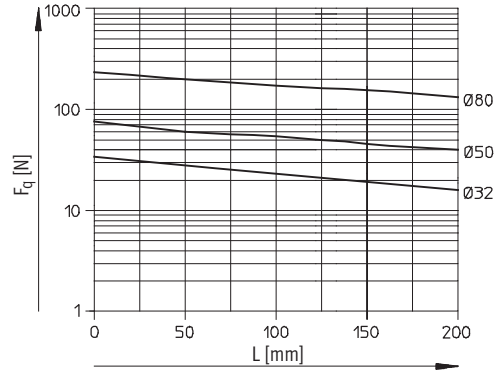

F_q with 250 mm stroke

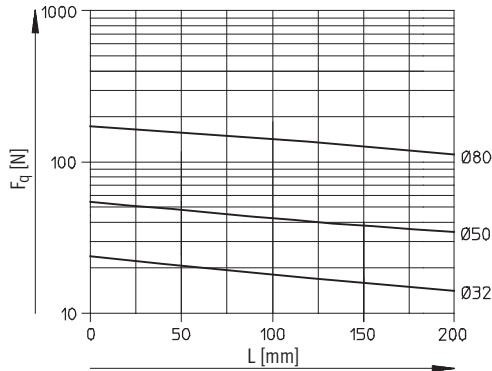

F_q with 320 mm stroke

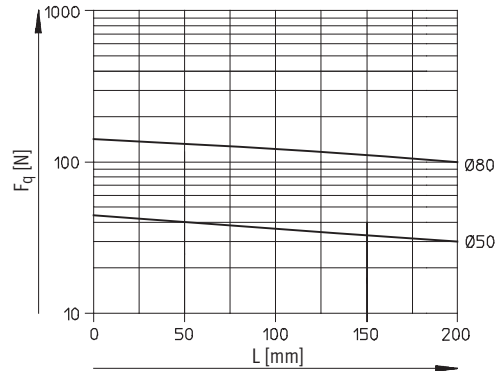

F_q with 400 mm stroke

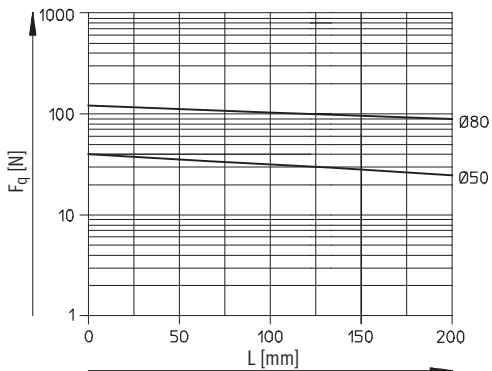

F_q with 500 mm stroke

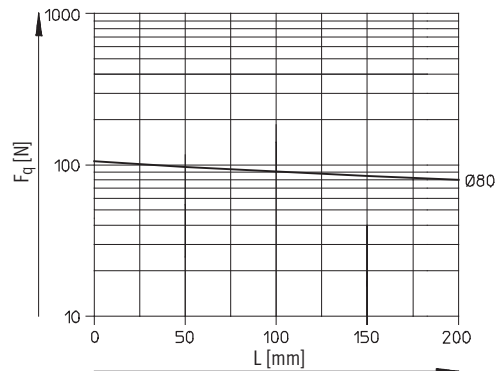

Guided cylinders DFP

Technical data

FESTO

Deflection f at the piston rod as a function of the lateral force F_q

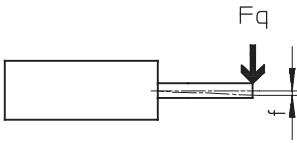

DFP-10

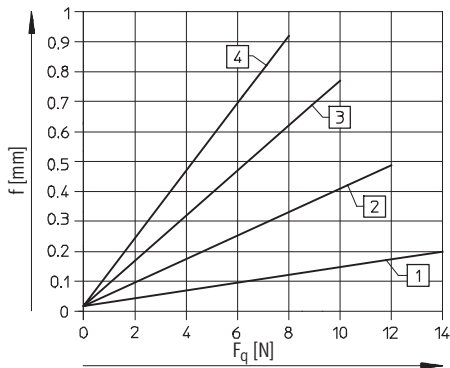

DFP-16

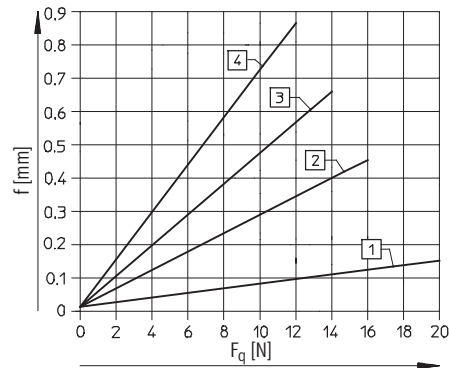

DFP-25

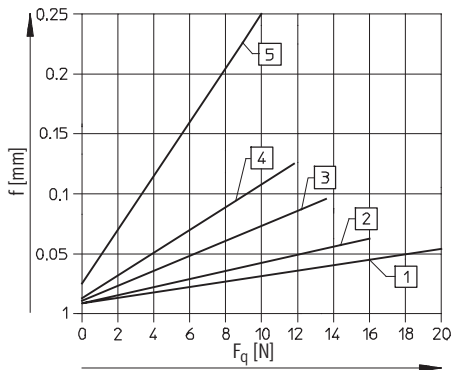

DFP-32

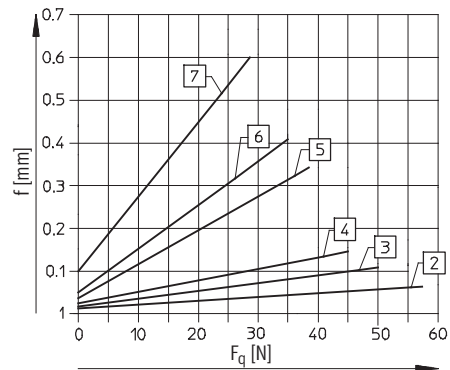

DFP-50

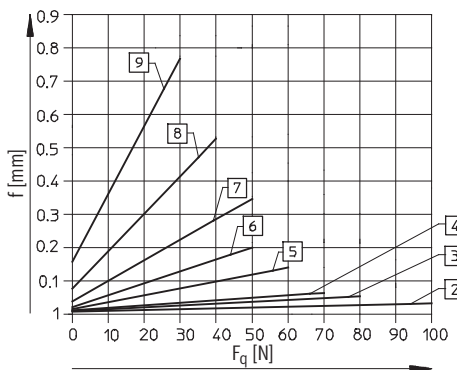

DFP-80

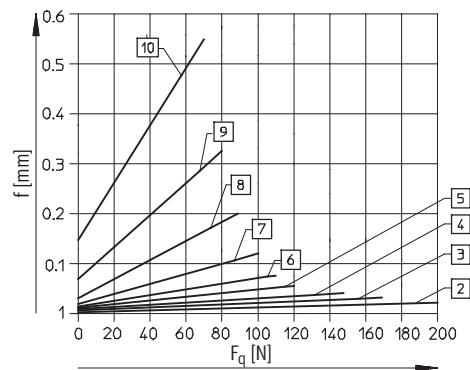

- 1 25 mm stroke
- 2 50 mm stroke
- 3 80 mm stroke

- 4 100 mm stroke
- 5 160 mm stroke
- 6 200 mm stroke

- 7 250 mm stroke
- 8 320 mm stroke

- 9 400 mm stroke
- 10 500 mm stroke

Guided cylinders DFP

Technical data

Torsion angle α of the piston rod as a function of the torque M

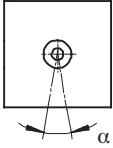

DFP-10

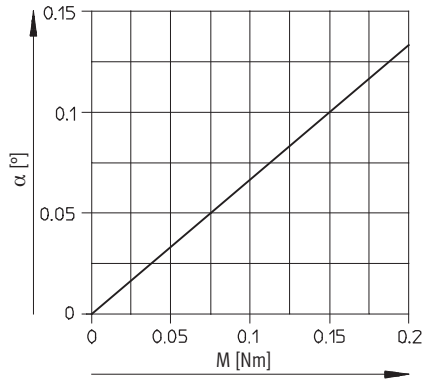

DFP-16

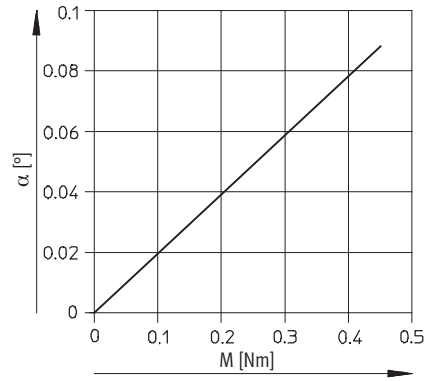

DFP-25

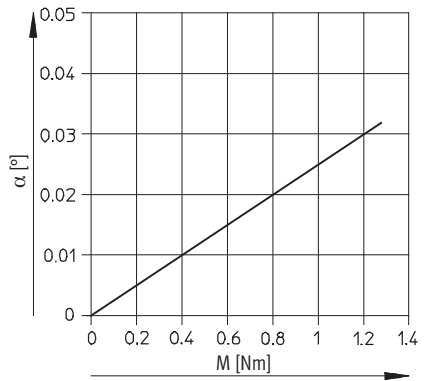

DFP-32

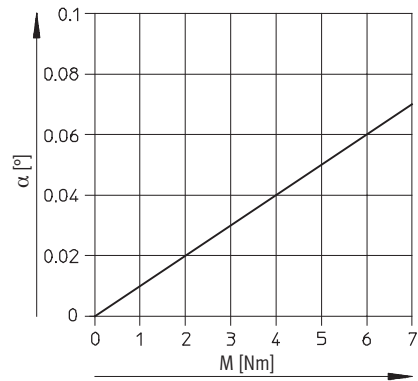

DFP-50

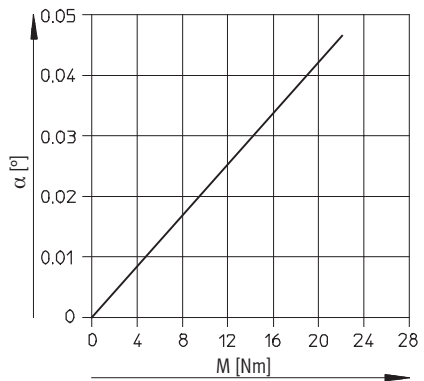

DFP-80

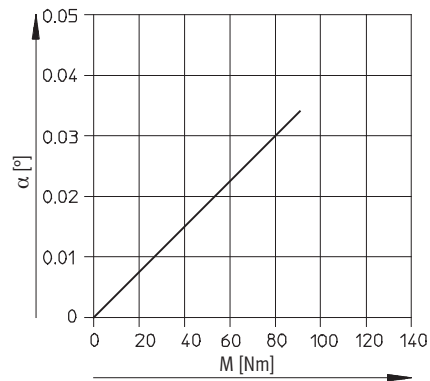

Guided cylinders DFP

Technical data

FESTO

Dimensions

Download CAD Data → www.festo.com/us/cad

Piston Ø 10...16 mm

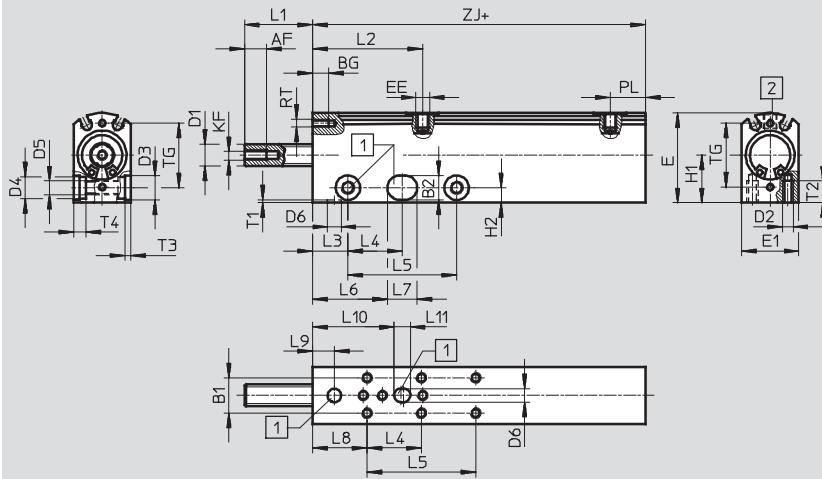

- 1 Centring hole for centring sleeves ZBH (accessory)
- 2 Mounting hole pattern (not for S2 variant)

+ = plus stroke length

Variant S2

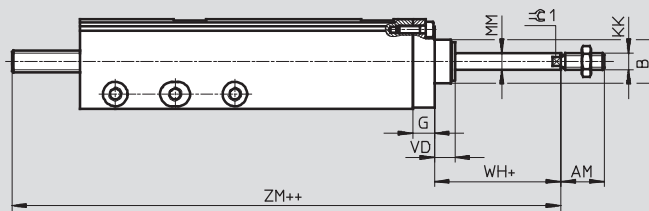

+ = plus stroke length

++ = plus 2x stroke length

Ø	AF	AM	B Ø	B1	B2 Ø H7	BG	D1 Ø h7	D2	D3 Ø H7	D4	D5	D6 Ø H7	E	E1	EE
10	8	12	–	11	7	6	6	M3	7	6	M4	5	28	17	M3
16	8	16	15.9	13	9	6	8	M4	9	8	M5	5	33	21	M5

Ø	G	H1	H2	KF	KK	L1	L2	L3	L4	L5 ¹⁾	L6	L7	L8	L9	L10
[mm]						min.									
10	6	14.3	4.5	M4	M4	25	38.5	12.5	25	50	33	9	5.5	5.5	28.5
16	8	17.5	5.5	M4	M6	25	40.5	13	20	44	27.5	11	20	8	30

Ø	L11	MM Ø	PL	RT	T1	T2	T3	T4	TG	VD	WH	ZJ	ZM	⊖ 1
[mm]														
10	6	4	12	M2.5	1	6	1.6	3.2	21	–	4.8	65	100.8	–
16	6	6	13	M3	1	8	2.1	4.6	23.5	7.5	12.5	72.5	118	5

1) With stroke > 80 mm

Guided cylinders DFP

Technical data

FESTO

Dimensions

Download CAD Data → www.festo.com/us/cad

Piston Ø 25 ... 80 mm

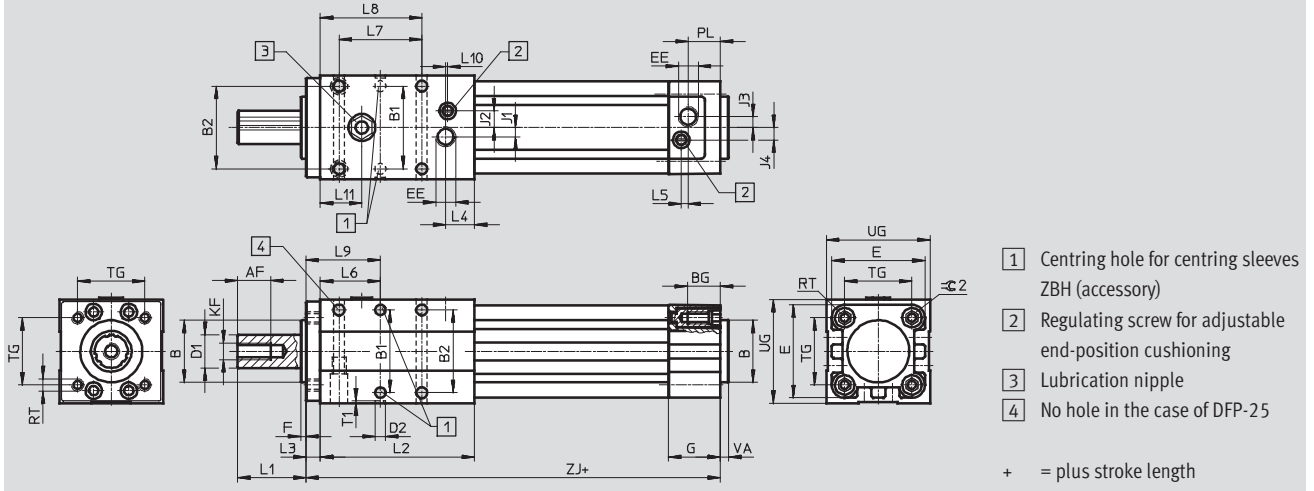

Variant S2

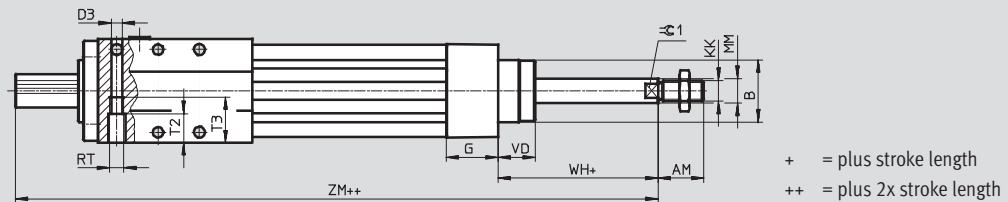

Ø	AF	AM	B	B1	B2	BG	D1	D2	D3	I	EE	F	G	J1	J2
[mm]			Ø d11	±0.02			Ø h7	Ø H7	Ø						
25	12.5	22	25	31	31	14	13	5	4.5	38	G $\frac{1}{8}$	2.5	22	3.6	7
32	16	22	30	40	40	16	16	5	5.3	45	G $\frac{1}{8}$	2.5	25.1	4.5	8
50	20	32	40	52	52	17	25	9	6.6	64	G $\frac{1}{4}$	2.5	29.6	7.5	14
80	24	40	45	75	75	17	40	9	8.4	93	G $\frac{3}{8}$	2.5	35.9	7	20

Ø	J3	J4	KF	KK	L1	L2	L3	L4	L5	L6	L7	L8	L9	L10	L11
[mm]															
25	3.1	6	M6	M10x1.25	30	58	6.5	11.8	4.1	22.5	31	38	29	2.3	12.8
32	5.2	6	M8	M10x1.25	32	74.5	7	14	3.3	29	40	49	36	1	20
50	8.5	10.4	M10	M16x1.5	40	107.5	10	18	5.1	44	52	70	54	4.2	29
80	8	12.5	M12	M20x1.5	41	143	14	23	10.5	58.5	75	96	72.5	5	39.5

Ø	MM	PL	RT	T1	T2	T3	TG	UG	VA	VD	WH	ZJ	ZM	≈C1	≈C2
[mm]	Ø f8														
25	10	8.5	M5	1	11	21	27	40	2	17.5	29.4	119.5	179	9	5
32	12	15.6	M6	1	14	22	32.5	50	4	18	26	150.4	210	10	6
50	20	14	M8	2.1	16	32	46.5	66	4	28	37	194	273	17	8
80	25	16.4	M10	2.1	20	40	72	96	4	34.7	46	249	338	22	6

Guided cylinders DFP

Technical data

FESTO

Ordering data – Basic version						
Design	Stroke [mm]	Part No.	Type ¹⁾	Stroke [mm]	Part No. Type ¹⁾	
	Piston Ø 10 mm			Piston Ø 16 mm		
	25	186 729	DFP-10-25-P-A	25	186 733 DFP-16-25-P-A	
	50	186 730	DFP-10-50-P-A	50	186 734 DFP-16-50-P-A	
	80	186 731	DFP-10-80-P-A	80	186 735 DFP-16-80-P-A	
	100	186 732	DFP-10-100-P-A	100	186 736 DFP-16-100-P-A	
	Piston Ø 25 mm			Piston Ø 32 mm		
	25	186 737	DFP-25-25-PPV-A	25	– –	
	50	186 738	DFP-25-50-PPV-A	50	186 742 DFP-32-50-PPV-A	
	80	186 739	DFP-25-80-PPV-A	80	186 743 DFP-32-80-PPV-A	
	100	186 740	DFP-25-100-PPV-A	100	186 744 DFP-32-100-PPV-A	
	160	186 741	DFP-25-160-PPV-A	160	186 745 DFP-32-160-PPV-A	
	200	–	–	200	186 746 DFP-32-200-PPV-A	
	250	–	–	250	186 747 DFP-32-250-PPV-A	
	Piston Ø 50 mm			Piston Ø 80 mm		
	50	186 748	DFP-50-50-PPV-A	50	186 756 DFP-80-50-PPV-A	
	80	186 749	DFP-50-80-PPV-A	80	186 757 DFP-80-80-PPV-A	
	100	186 750	DFP-50-100-PPV-A	100	186 758 DFP-80-100-PPV-A	
	160	186 751	DFP-50-160-PPV-A	160	186 759 DFP-80-160-PPV-A	
	200	186 752	DFP-50-200-PPV-A	200	186 760 DFP-80-200-PPV-A	
	250	186 753	DFP-50-250-PPV-A	250	186 761 DFP-80-250-PPV-A	
	320	186 754	DFP-50-320-PPV-A	320	186 762 DFP-80-320-PPV-A	
	400	186 755	DFP-50-400-PPV-A	400	186 763 DFP-80-400-PPV-A	
	500	–	–	500	186 764 DFP-80-500-PPV-A	

1) In each case the scope of delivery includes 2 of the centring sleeves listed as accessories. Centring sleeves are supplied to repeat order in packs of 10. Proximity sensors and mounting screws are not included in the scope of delivery for guided cylinders.

Guided cylinders DFP

Technical data

FESTO

Ordering data – Variants						
Design	Stroke [mm]	Part No.	Type ¹⁾²⁾	Stroke [mm]	Part No. Type ¹⁾²⁾	
S2 – Through piston rod						
	Piston Ø 10 mm			Piston Ø 16 mm		
	25	186 765	DFP-10-25-P-A-S2	25	186 769	DFP-16-25-P-A-S2
	50	186 766	DFP-10-50-P-A-S2	50	186 770	DFP-16-50-P-A-S2
	80	186 767	DFP-10-80-P-A-S2	80	186 771	DFP-16-80-P-A-S2
	100	186 768	DFP-10-100-P-A-S2	100	186 772	DFP-16-100-P-A-S2
	Piston Ø 25 mm			Piston Ø 32 mm		
	25	186 773	DFP-25-25-PPV-A-S2	25	–	–
	50	186 774	DFP-25-50-PPV-A-S2	50	186 778	DFP-32-50-PPV-A-S2
	80	186 775	DFP-25-80-PPV-A-S2	80	186 779	DFP-32-80-PPV-A-S2
	100	186 776	DFP-25-100-PPV-A-S2	100	186 780	DFP-32-100-PPV-A-S2
	160	186 777	DFP-25-160-PPV-A-S2	160	186 781	DFP-32-160-PPV-A-S2
	200	–	–	200	186 782	DFP-32-200-PPV-A-S2
	250	–	–	250	186 783	DFP-32-250-PPV-A-S2
	Piston Ø 50 mm			Piston Ø 80 mm		
	50	186 784	DFP-50-50-PPV-A-S2	50	186 792	DFP-80-50-PPV-A-S2
	80	186 785	DFP-50-80-PPV-A-S2	80	186 793	DFP-80-80-PPV-A-S2
	100	186 786	DFP-50-100-PPV-A-S2	100	186 794	DFP-80-100-PPV-A-S2
	160	186 787	DFP-50-160-PPV-A-S2	160	186 795	DFP-80-160-PPV-A-S2
	200	186 788	DFP-50-200-PPV-A-S2	200	186 796	DFP-80-200-PPV-A-S2
	250	186 789	DFP-50-250-PPV-A-S2	250	186 797	DFP-80-250-PPV-A-S2
	320	186 790	DFP-50-320-PPV-A-S2	320	186 798	DFP-80-320-PPV-A-S2
	400	186 791	DFP-50-400-PPV-A-S2	400	186 799	DFP-80-400-PPV-A-S2
	500	–	–	500	186 800	DFP-80-500-PPV-A-S2

- 1) In each case the scope of delivery includes 2 of the centring sleeves listed as accessories. Centring sleeves are supplied to repeat order in packs of 10. Proximity sensors and mounting screws are not included in the scope of delivery for guided cylinders.
- 2) The scope of delivery also includes a hex nut for the piston rod thread.

Guided cylinders DFP

Accessories



Push-on flange FFP

for piston \varnothing 10 ... 16 mm

Material:

Wrought aluminium alloy

Free of copper, PTFE and silicone

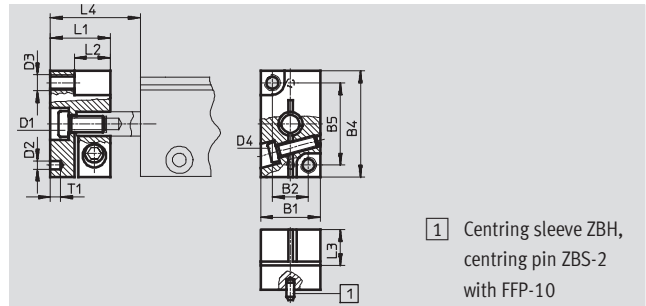

1) Centring sleeve ZBH,
centring pin ZBS-2
with FFP-10

Dimensions and ordering data

For \varnothing	B1	B2	B4	B5	D1	D2	D3	D4	L1	L2	L3	L4	T1	CRC ¹⁾	Part No.	Type
[mm]		± 0.02				\varnothing H7							+0.2			
10	15	9	26	20	M4	2	M4	M3	15	8.5	9	31.5	2.5	2	186 801	FFP-10
16	19	12	33	26	M4	5	M4	M4	17	10.5	11	31.5	1	2	186 802	FFP-16

1) Corrosion resistance class 2 according to Festo standard 940 070

Components requiring moderate corrosion resistance. Externally visible parts with primarily decorative surface requirements which are in direct contact with a surrounding industrial atmosphere or media such as cooling or lubricating agents

Push-on flange FFP

for piston \varnothing 25 ... 80 mm

Material:

Wrought aluminium alloy

Free of copper, PTFE and silicone

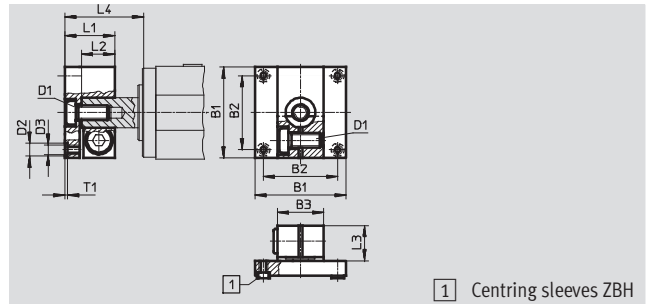

1) Centring sleeves ZBH

Dimensions and ordering data

For \varnothing	B1	B2	B3	D1	D2	D3	L1	L2	L3	L4	T1	CRC ¹⁾	Part No.	Type
[mm]		± 0.02			\varnothing H7						+0.2			
25	38	30	22	M6	7	M5	27	18	19	39	1.6	2	186 803	FFP-25
32	49	40	25	M8	7	M5	27	18	19	41	1.6	2	186 804	FFP-32
50	64	50	36	M10	9	M6	35	23	25	52	2.1	2	186 805	FFP-50
80	94	70	54	M12	12	M8	40	25	27	56	2.6	2	186 806	FFP-80

1) Corrosion resistance class 2 according to Festo standard 940 070

Components requiring moderate corrosion resistance. Externally visible parts with primarily decorative surface requirements which are in direct contact with a surrounding industrial atmosphere or media such as cooling or lubricating agents

Guided cylinders DFP

Accessories

Centring sleeves ZBH

Material:
Steel, corrosion resistant
Free of copper, PTFE and silicone

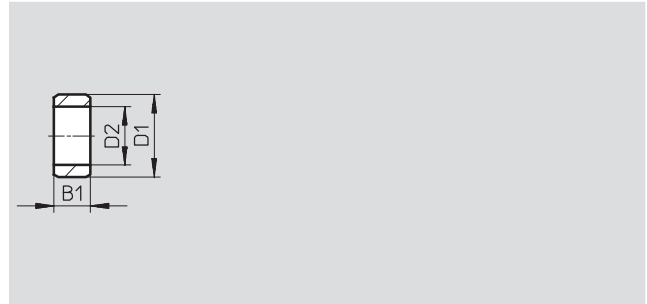

Dimensions and ordering data							
D1	B1	D2	CRC ¹⁾	Weight	Part No.	Type	PU ²⁾
∅		∅		[g]			
h7	-0.2						
5	2.4	3.2	2	1	189 652	ZBH-5	10
7	3	5.3	2	1	186 717	ZBH-7	10
9	4	6.4	2	1	150 927	ZBH-9	10

1) Corrosion resistance class 2 according to Festo standard 940 070

Components requiring moderate corrosion resistance. Externally visible parts with primarily decorative surface requirements which are in direct contact with a surrounding industrial atmosphere or media such as cooling or lubricating agents

2) Packaging unit quantity

Ordering data – Proximity sensors for C-slot, magneto-resistive						Technical data → Internet: smt	
	Type of mounting	Switch output	Electrical connection, connection direction	Cable length [m]	Part No.	Type	
N/O contact							
	Insertable in the slot from above	PNP	Cable, 3-wire, in-line	2.5	551 373	SMT-10M-PS-24V-E-2,5-L-OE	
			Plug M8x1, 3-pin, in-line	0.3	551 375	SMT-10M-PS-24V-E-0,3-L-M8D	
			Plug M8x1, 3-pin, lateral	0.3	551 376	SMT-10M-PS-24V-E-0,3-Q-M8D	



Ordering data – Proximity sensors for C-slot, magnetic reed						Technical data → Internet: sme	
	Type of mounting	Switch output	Electrical connection, connection direction	Cable length [m]	Part No.	Type	
N/O contact							
	Insertable in the slot from above	Contacting	Plug M8x1, 3-pin, in-line	0.3	551 367	SME-10M-DS-24V-E-0,3-L-M8D	
			Cable, 3-wire, in-line	2.5	551 365	SME-10M-DS-24V-E-2,5-L-OE	
			Cable, 2-wire, in-line	2.5	551 369	SME-10M-ZS-24V-E-2,5-L-OE	
	Insertable in the slot lengthwise	Contacting	Plug M8x1, 3-pin, in-line	0.3	173 212	SME-10-SL-LED-24	
			Cable, 3-wire, in-line	2.5	173 210	SME-10-KL-LED-24	

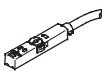
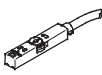

Guided cylinders DFP

Accessories

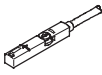
FESTO

Ordering data – Proximity sensors for T-slot, magneto-resistive					Technical data → Internet: smt	
	Type of mounting	Switch output	Electrical connection	Cable length [m]	Part No.	Type
N/O contact						
	Insertable in the slot from above, flush with cylinder profile, short design	PNP	Cable, 3-wire	2.5	574335	SMT-8M-A-PS-24V-E-2,5-OE
			Plug M8x1, 3-pin	0.3	574334	SMT-8M-A-PS-24V-E-0,3-M8D
			Plug M12x1, 3-pin	0.3	574337	SMT-8M-A-PS-24V-E-0,3-M12
		NPN	Cable, 3-wire	2.5	574338	SMT-8M-A-NS-24V-E-2,5-OE
			Plug M8x1, 3-pin	0.3	574339	SMT-8M-A-NS-24V-E-0,3-M8D
N/C contact						
	Insertable in the slot from above, flush with cylinder profile, short design	PNP	Cable, 3-wire	7.5	574340	SMT-8M-A-PO-24V-E-7,5-OE

Ordering data – Proximity sensors for T-slot, magnetic reed					Technical data → Internet: sme	
	Type of mounting	Switch output	Electrical connection	Cable length [m]	Part No.	Type
N/O contact						
	Insertable in the slot from above, flush with cylinder profile	Contacting	Cable, 3-wire	2.5	543 862	SME-8M-DS-24V-K-2,5-OE
				5.0	543 863	SME-8M-DS-24V-K-5,0-OE
			Cable, 2-wire	2.5	543 872	SME-8M-ZS-24V-K-2,5-OE
			Plug M8x1, 3-pin	0.3	543 861	SME-8M-DS-24V-K-0,3-M8D
	Insertable in the slot lengthwise, flush with the cylinder profile	Contacting	Cable, 3-wire	2.5	150 855	SME-8-K-LED-24
			Plug M8x1, 3-pin	0.3	150 857	SME-8-S-LED-24
N/C contact						
	Insertable in the slot lengthwise, flush with the cylinder profile	Contacting	Cable, 3-wire	7.5	160 251	SME-8-O-K-LED-24

Ordering data – Connecting cables				Technical data → Internet: nebu	
	Electrical connection, left	Electrical connection, right	Cable length [m]	Part No.	Type
	Straight socket, M8x1, 3-pin	Cable, open end, 3-wire	2,5	541 333	NEBU-M8G3-K-2.5-LE3
			5	541 334	NEBU-M8G3-K-5-LE3
	Straight socket, M12x1, 5-pin	Cable, open end, 3-wire	2,5	541 363	NEBU-M12G5-K-2.5-LE3
			5	541 364	NEBU-M12G5-K-5-LE3
	Angled socket, M8x1, 3-pin	Cable, open end, 3-wire	2,5	541 338	NEBU-M8W3-K-2.5-LE3
			5	541 341	NEBU-M8W3-K-5-LE3
	Angled socket, M12x1, 5-pin	Cable, open end, 3-wire	2,5	541 367	NEBU-M12W5-K-2.5-LE3
			5	541 370	NEBU-M12W5-K-5-LE3

Ordering data – Slot cover for T-slot			Part No.	Type
	Mounting	Length		
	Insertable from above	2x 0.5 m	151 680	ABP-5-S

Product Range and Company Overview

A Complete Suite of Automation Services

Our experienced engineers provide complete support at every stage of your development process, including: conceptualization, analysis, engineering, design, assembly, documentation, validation, and production.



Custom Automation Components
Complete custom engineered solutions



Custom Control Cabinets
Comprehensive engineering support and on-site services



Complete Systems
Shipment, stocking and storage services

The Broadest Range of Automation Components

With a comprehensive line of more than 30,000 automation components, Festo is capable of solving the most complex automation requirements.



Electromechanical
Electromechanical actuators, motors, controllers & drives



Pneumatics
Pneumatic linear and rotary actuators, valves, and air supply



PLCs and I/O Devices
PLC's, operator interfaces, sensors and I/O devices

Supporting Advanced Automation... As No One Else Can!

Festo is a leading global manufacturer of pneumatic and electromechanical systems, components and controls for industrial automation, with more than 12,000 employees in 56 national headquarters serving more than 180 countries. For more than 80 years, Festo has continuously elevated the state of manufacturing with innovations and optimized motion control solutions that deliver higher performing, more profitable automated manufacturing and processing equipment. Our dedication to the advancement of automation extends beyond technology to the education and development of current and future automation and robotics designers with simulation tools, teaching programs, and on-site services.

Quality Assurance, ISO 9001 and ISO 14001 Certifications

Festo Corporation is committed to supply all Festo products and services that will meet or exceed our customers' requirements in product quality, delivery, customer service and satisfaction.

To meet this commitment, we strive to ensure a consistent, integrated, and systematic approach to management that will meet or exceed the requirements of the ISO 9001 standard for Quality Management and the ISO 14001 standard for Environmental Management.



© Copyright 2008, Festo Corporation. While every effort is made to ensure that all dimensions and specifications are correct, Festo cannot guarantee that publications are completely free of any error, in particular typing or printing errors. Accordingly, Festo cannot be held responsible for the same. For Liability and Warranty conditions, refer to our "Terms and Conditions of Sale", available from your local Festo office. All rights reserved. No part of this publication may be reproduced, distributed, or transmitted in any form or by any means, electronic, mechanical, photocopying or otherwise, without the prior written permission of Festo. All technical data subject to change according to technical update.



Printed on recycled paper at New Horizon Graphic, Inc., FSC certified as an environmentally friendly printing plant.

Festo North America

Festo Regional Contact Center

5300 Explorer Drive
Mississauga, Ontario L4W 5G4
Canada

USA Customers:

For ordering assistance,

Call: 1.800.99.FESTO (1.800.993.3786)

Fax: 1.800.96.FESTO (1.800.963.3786)

Email: customer.service@us.festo.com

For technical support,

Call: 1.866.GO.FESTO (1.866.463.3786)

Fax: 1.800.96.FESTO (1.800.963.3786)

Email: product.support@us.festo.com

Canadian Customers:

Call: 1.877.GO.FESTO (1.877.463.3786)

Fax: 1.877.FX.FESTO (1.877.393.3786)

Email: festo.canada@ca.festo.com

USA Headquarters

Festo Corporation
395 Moreland Road
P.O. Box 18023
Hauppauge, NY 11788, USA
www.festo.com/us

USA Sales Offices

Appleton

North 922 Tower View Drive, Suite N
Greenville, WI 54942, USA

Boston

120 Presidential Way, Suite 330
Woburn, MA 01801, USA

Chicago

1441 East Business Center Drive
Mt. Prospect, IL 60056, USA

Dallas

1825 Lakeway Drive, Suite 600
Lewisville, TX 75057, USA

Detroit – Automotive Engineering Center

2601 Cambridge Court, Suite 320
Auburn Hills, MI 48326, USA

New York

395 Moreland Road
Hauppauge, NY 11788, USA

Silicon Valley

4935 Southfront Road, Suite F
Livermore, CA 94550, USA

United States



USA Headquarters, East: Festo Corp., 395 Moreland Road, Hauppauge, NY 11788

Phone: 1.631.435.0800; Fax: 1.631.435.8026;

Email: info@festo-usa.com

www.festo.com/us

Canada



Headquarters: Festo Inc., 5300 Explorer Drive, Mississauga, Ontario L4W 5G4

Phone: 1.905.624.9000; Fax: 1.905.624.9001;

Email: festo.canada@ca.festo.com

www.festo.ca

Mexico



Headquarters: Festo Pneumatic, S.A., Av. Ceylán 3, Col. Tequesquahuac,
54020 Tlalneantla, Edo. de México

Phone: 011 52 [55] 53 21 66 00; Fax: 011 52 [55] 53 21 66 65;

Email: festo.mexico@mx.festo.com

www.festo.com/mx

Central USA

Festo Corporation
1441 East Business
Center Drive
Mt. Prospect, IL 60056, USA
Phone: 1.847.759.2600
Fax: 1.847.768.9480



Western USA

Festo Corporation
4935 Southfront Road,
Suite F
Livermore, CA 94550, USA
Phone: 1.925.371.1099
Fax: 1.925.245.1286



Festo Worldwide

Argentina Australia Austria Belarus Belgium Brazil Bulgaria Canada Chile China Colombia Croatia Czech Republic Denmark
Estonia Finland France Germany Great Britain Greece Hong Kong Hungary India Indonesia Iran Ireland Israel Italy Japan Latvia
Lithuania Malaysia Mexico Netherlands New Zealand Norway Peru Philippines Poland Romania Russia Serbia Singapore
Slovakia Slovenia South Africa South Korea Spain Sweden Switzerland Taiwan Thailand Turkey Ukraine United States Venezuela

www.festo.com