

Motor controller CMMO-ST

FESTO

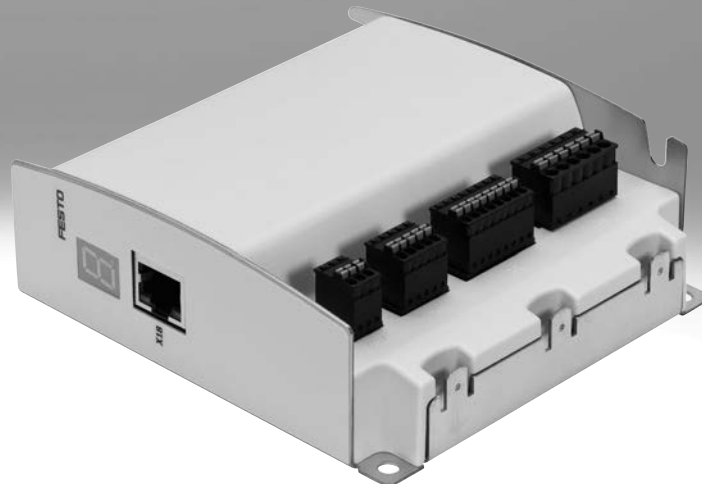

Festo core product range
Covers 80% of your automation tasks

Worldwide:
Superb:
Easy:

Always in stock
Festo quality at an attractive price
Simplified procurement and warehousing

- ★ Generally ready for dispatch from the factory within 24 hours
In stock at 13 Service Centres worldwide
More than 2200 products
- ★ Generally ready for dispatch from the factory within 5 days
Assembled for you at 4 Service Centres worldwide
Up to 6×10^{12} variants per product family

Just look
for the
star!

Key features

At a glance

- The motor controller CMMO-ST is an open- and closed-loop position controller
- Separate load and logic supply
- Supports the safe torque off (STO) safety function
- Easy to control via:
 - I/O interface
 - IO-Link or I-Port
 - Modbus TCP

- Monitoring of freely defined positions and torque ranges
- Backup file enables seamless device replacement
- H-rail mounting possible
- Encoder option (closed loop), in other words no step losses, following errors are corrected

Parameterisation possible via:

- Configuration package FCT (Festo Configuration Tool)
- Ethernet interface with integrated web server

Communication system IO-Link

IO-Link

IO-Link is a standardised I/O technology (IEC 61131-9) which enables communication with sensors and actuators.

This is a form of point-to-point communication.

The data profile FHPP is transmitted via the physical interface.

Specific I-Port interface from Festo

The I-Port interface is based on IO-Link technology and enables communication with sensors and actuators.

The advantage is that the connected devices are automatically detected by Festo (plug and work).

The data profile FHPP is transmitted via the physical interface.

Communication system Modbus TCP

Modbus

Modbus TCP is an open communication protocol (IEC 61158) based on the master-slave architecture. It is an established standard for communication via Ethernet-TCP/IP in automation technology.

The data profile FHPP is transmitted via the physical interface.

Description of the interfaces

With I/O interface

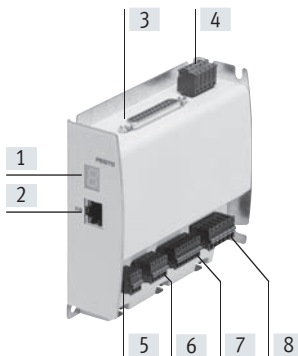

- [1] 7-segment display
- [2] Ethernet interface (RJ45)
- [3] I/O interface
- [4] Power supply

With IO-Link interface

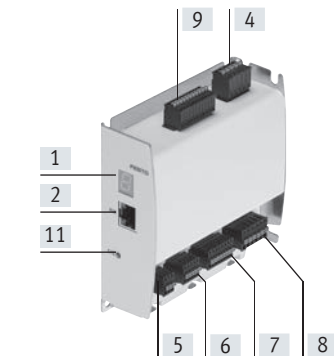

- [5] Reference switch
- [6] Safety function STO
- [7] Encoder
- [8] Motor

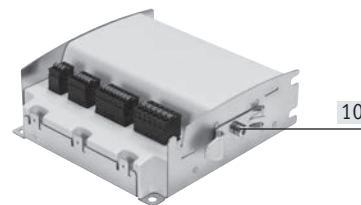

- [9] IO-Link interface
- [10] Mounting bracket for fitting on an H-rail
- [11] Status of IO-Link connection

For controlling

Electric cylinder EPCO

Toothed belt axis ELGR

Rotary drive ERMO

Stepper motor EMMS-ST



Key features

System overview

Fieldbus modules CTEU serve as an interface between the PLC controller and the motor controller CMMO-ST. This is then integrated into the control systems of various manufacturers using different bus nodes.

The following protocols are supported using the appropriate module:

- CANopen
- DeviceNet
- EtherCAT
- PROFIBUS
- PROFINET

For controlling:

Electric cylinder EPCO

Toothed belt axis ELGR

Rotary drive ERMO

Stepper motor EMMS-ST

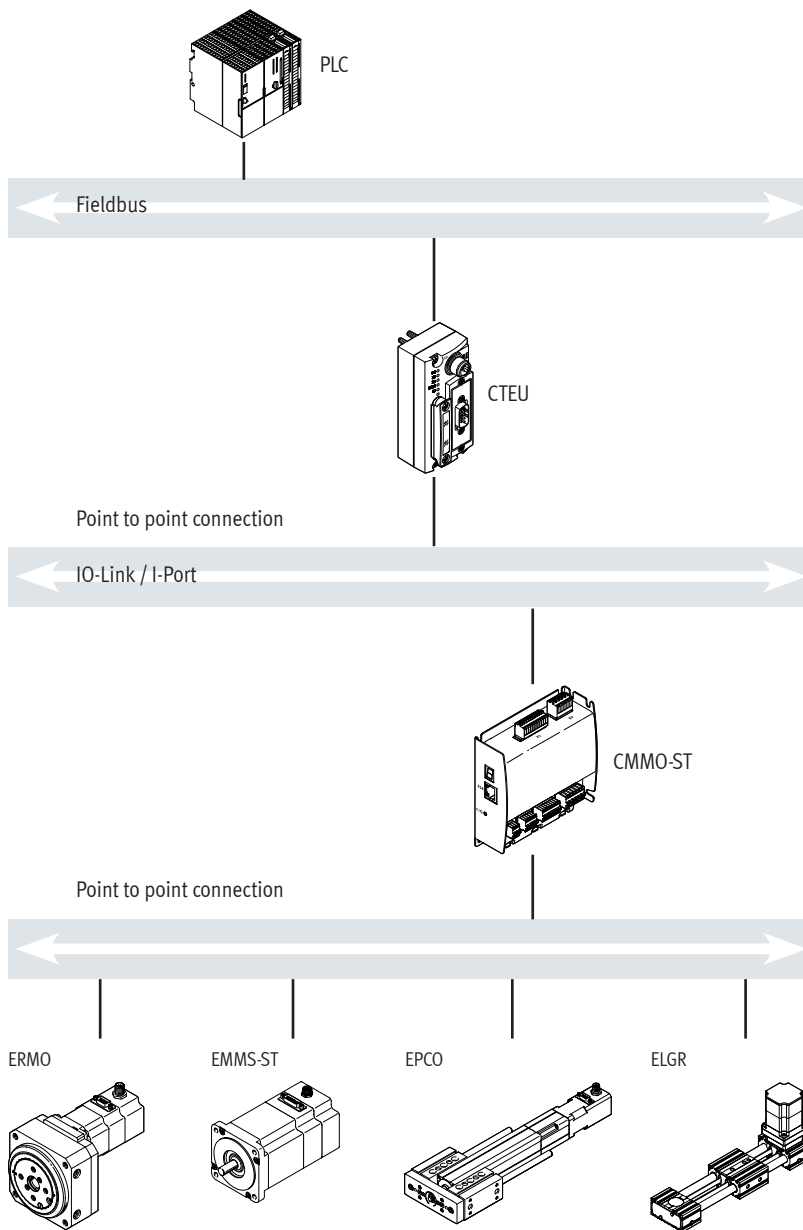

Key features

FCT software – Festo Configuration Tool

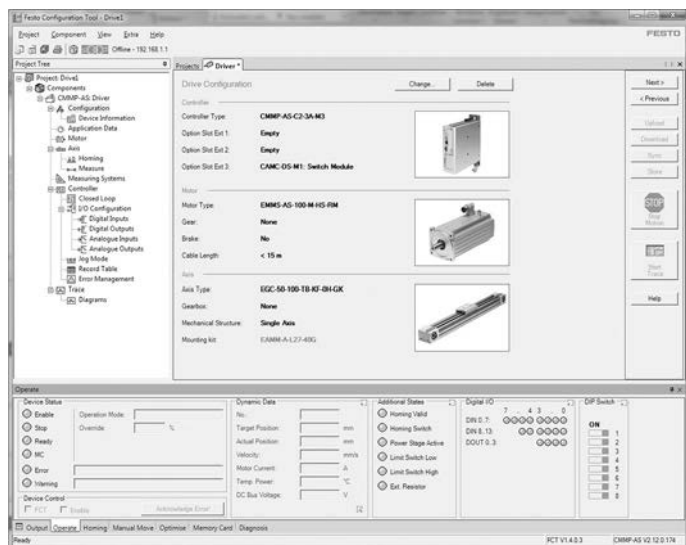

Software platform for electric drives from Festo

- All drives in a system can be managed and saved in a common project
- Project and data management for all supported device types
- Simple to use thanks to graphically supported parameter entry
- Universal mode of operation for all drives
- Work offline at your desk or online at the machine

Mechanical reference positions and limit positions

- Reference positions can be either edited or taught in
- Flexible adaptation to installation conditions
- Settings are displayed clearly

Position set table

- Up to 64 position sets ensure flexibility in positioning
- Absolute or relative positioning values can be used
- The following parameters can be set flexibly for each application:
 - Position
 - Speed
 - Acceleration
 - Braking ramps
- Force control
- Complete function test

Type codes

001	Series
CMMO	Motor controller

002	Motor type
ST	Stepper motor ST

003	Nominal current
C5	5 A

004	Nominal input voltage
1	24 V DC

005	Bus protocol/activation
DIO	Digital I/O interface
LK	IO-Link®

006	Switching input/output
P	PNP
N	NPN

Data sheet

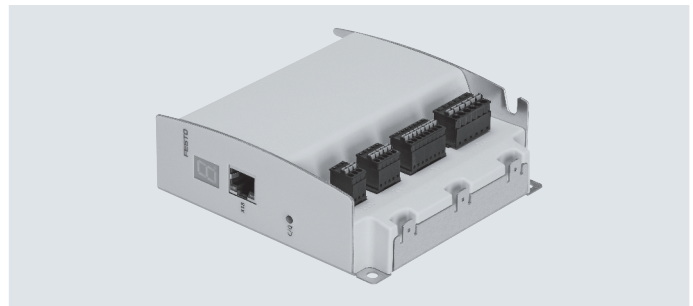

General technical data		
Type CMMO-ST...	-DIO	-LK
Operating mode	Cascade controller with PI speed controller PI current regulator P position controller PWM-MOSFET power output stage	
Operating mode		
Open-loop operation	Sinusoidal current form	
Closed-loop operation	Controlled sinusoidal current, cascade controller for speed and position	
Display	7-segment display	
Rotor position sensor	Encoder	
Encoder interface input	RS422	
Parameterisation interface	Ethernet	
Ethernet, supported protocols	TCP/IP	TCP/IP, Modbus TCP
Protocol	–	IO-Link I-Port Modbus TCP
Position sets	32	64
Communication profile	–	FHPP
Number of digital logic inputs	11	1
Number of digital logic outputs	11	3
Characteristics of digital logic outputs	Freely configurable in some cases Not galvanically isolated	
Adjustable current reduction	Via software	
Nominal current setting	Via software	
Braking resistor	[Ω]	15
Pulse power of braking resistor	[kVA]	0.1
Mains filter	Integrated	
Type of mounting	Screwed onto connecting plate, lying down or upright With H-rail	
Product weight	[g]	290

Data sheet

Electrical data				
Type CMMO-ST...		-DIOP	-DION	-LKP
General				
Max. DC link voltage	[V DC]	28		31
Nominal output current	[A]	5.7		
Load voltage				
Nominal voltage	[V DC]	24 ±15%		
Nominal current	[A]	6		
Peak current	[A]	8		
Logic supply				
Nominal voltage	[V DC]	24 ±15%		
Nominal current	[A]	0.3		
Operating range of logic input	[V]	24		
Max. current per output (digital logic outputs)	[mA]	100		
Switching logic, input/output		PNP	NPN	PNP

Safety data	
Safety function to EN 61800-5-2	Safe torque off (STO)
Performance level (PL) to EN ISO 13849-1	Category 3, Performance Level e
Safety Integrity Level (SIL) to EN 61800-5-2, EN 62061, EN 61508	SIL 3 / SIL CL 3
Certificate issuing authority	German Technical Control Board (TÜV) 01/205/5165.01/14
Proof test interval	20a
PFH	1.3×10^{-10}
Diagnostic coverage [%]	90
Safe failure fraction (SFF) [%]	99.8
Hardware fault tolerance	1
CE marking (see declaration of conformity)	In accordance with EU EMC Directive ¹⁾ In accordance with EU Machinery Directive
Shock resistance	To EN 60068-2-29
Vibration resistance	To EN 60068-2-6

- 1) For information about the area of use, see the EC declaration of conformity at: www.festo.com/sp → Certificates.
If the devices are subject to usage restrictions in residential, commercial or light-industrial environments, further measures for the reduction of the emitted interference may be necessary.

Technical data – CMMO-ST...-LK (IO-Link)	
Connection technology	Cage Clamp
Protocol version	Device V1.1
Communication mode	COM3 (230.4 kBaud)
Number of ports	Device 1
Process data width OUT	8 or 16 bytes parameterisable FHPP or FHPP+FPC parameterisable
Process data width IN	8 or 16 bytes parameterisable FHPP or FHPP+FPC parameterisable
Min. cycle time [ms]	1

Data sheet

Operating and environmental conditions	
Characteristics of digital logic outputs	Not galvanically isolated
Characteristics of logic inputs	Galvanically connected to logic potential
Logic input specification	Based on IEC 61131-2
Degree of protection	IP40
Protective function	I ^t monitoring
	Following error monitoring
	Software end-position detection
	Voltage failure detection
	Current monitoring
	Temperature monitoring
Ambient temperature	[°C] 0 ... +50
UL ambient temperature	[°C] 0 ... +40
Storage temperature	[°C] -25 ... +75
Relative humidity	[%] 0 ... 90 (non-condensing)
Certification	c UL us listed (OL)
	RCM compliance mark
CE marking (see declaration of conformity)	In accordance with EU EMC Directive ¹⁾
	In accordance with EU Machinery Directive
KC mark	KC-EMV
Note on materials	RoHS-compliant

1) For information about the area of use, see the EC declaration of conformity at: www.festo.com/sp → Certificates.

If the devices are subject to usage restrictions in residential, commercial or light-industrial environments, further measures for the reduction of the emitted interference may be necessary.

Data sheet

Pin allocation for CMMO-ST-...-DIO

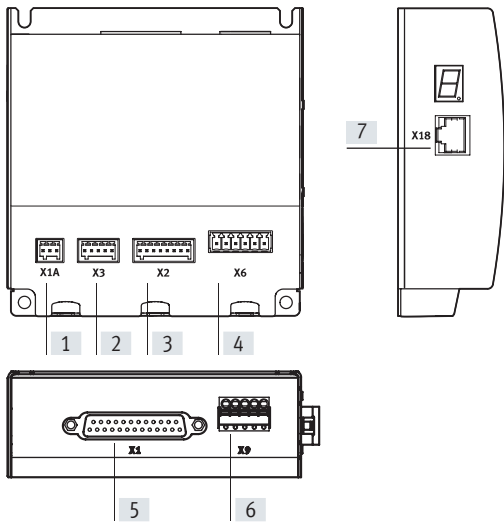

[1] Reference switch

Pin	Function
1	+24 V (logic output)
2	Signal
3	0 V

[2] Safety function STO

Pin	Function
1	+24 V (logic output)
2	STO 1
3	STO 2
4	Diagnostics 1
5	Diagnostics 2

[3] Encoder

Pin	Function
1	A
2	A/
3	B
4	B/
5	N
6	N/
7	+5 V (output)
8	0 V

[4] Motor

Pin	Function
1	String A
2	String A/
3	String B
4	String B/
5	Brake +24 V (switched output)
6	Brake 0 V

[5] I/O interface, 25-pin Sub-D plug

Pin	Function
1	Input 1
2	Input 2
3	Input 3
4	Input 4
5	Input 5
6	Input 6
7	Input 7
8	Input 8
9	Input 9
10	Input 10
11	Input 11
12	Output 1
13	Output 2
14	Output 3
15	Output 4
16	Output 5
17	Output 6
18	Output 7
19	Output 8
20	Output 9
21	Output 10
22	Output 11
23	n.c.
24	+24 V (logic output)
25	0 V

[6] Power supply

Pin	Function
1	n.c.
2	n.c.
3	+24 V (logic)
4	0 V
5	+24 V (load)

[7] Ethernet interface

Pin	Function
1	Tx+ (Transmit +)
2	Tx- (Transmit -)
3	Rx+ (Receive +)
4	n.c.
5	n.c.
6	Rx- (Receive -)
7	n.c.
8	n.c.

Data sheet

Pin allocation for CMMO-ST-...-LK

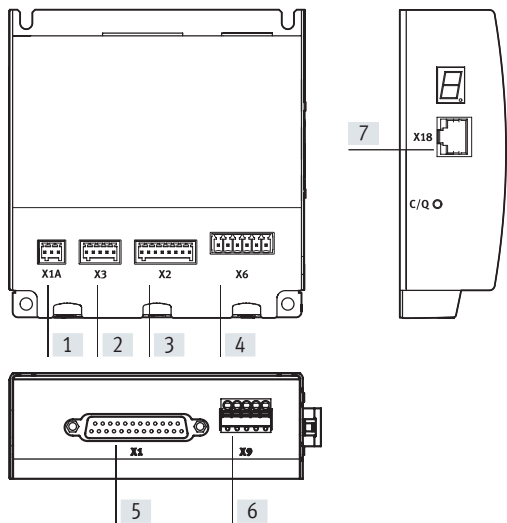

[1] Reference switch

Pin	Function
1	+24 V (logic output)
2	Signal
3	0 V

[2] Safety function STO

Pin	Function
1	+24 V (logic output)
2	STO 1
3	STO 2
4	Diagnostics 1
5	Diagnostics 2

[3] Encoder

Pin	Function
1	A
2	A/
3	B
4	B/
5	N
6	N/
7	+5 V (output)
8	0 V

[4] Motor

Pin	Function
1	String A
2	String A/
3	String B
4	String B/
5	Brake +24 V (switched output)
6	Brake 0 V

[5] I/O interface with IO-Link

Pin	Function
1	+24 V (logic output)

[5] I/O interface with IO-Link

Pin	Function
2	0 V
3	Parameterisable output 2
4	Parameterisable output 1
5	Ready/Error
6	Controller enable
7	n.c.
8	n.c.
9	L- (0 V IO-Link)
10	C/Q (IO-Link Signal)
11	L+ (+24 V supply to IO-Link)

[6] Power supply

Pin	Function
1	n.c.
2	n.c.
3	+24 V (logic)
4	0 V
5	+24 V (load)

[7] Ethernet interface

Pin	Function
1	Tx+ (Transmit +)
2	Tx- (Transmit -)
3	Rx+ (Receive +)
4	n.c.
5	n.c.
6	Rx- (Receive -)
7	n.c.
8	n.c.

Data sheet

Minimum distance between two motor controllers

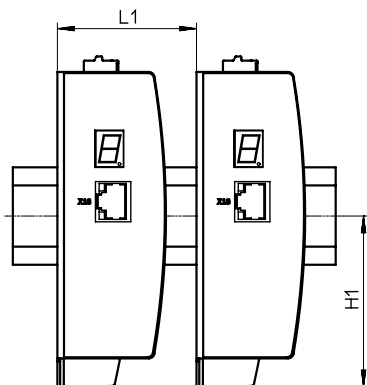

Type	L1	H1
CMMO-ST...	41	61.35

Dimensions Download CAD data → www.festo.com

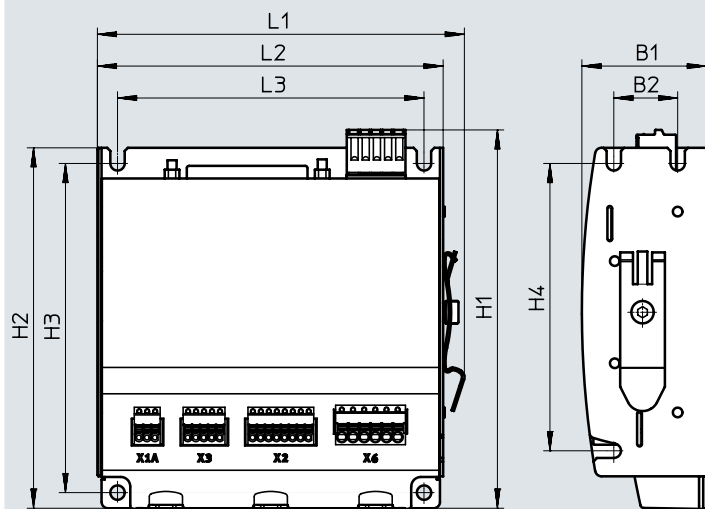

Type	B1	B2	H1	H2	H3	H4	L1	L2	L3
CMMO-ST...	39	20	118.7	113.1	103.1	90	115	108.8	96

★ Core product range



Ordering data	Description	Part no.	Type
	With I/O interface		
	Switching input/output PNP	★ 1512316	CMMO-ST-C5-1-DIOP
	Switching input/output NPN	★ 1512317	CMMO-ST-C5-1-DION
	With IO-Link		
	Switching input/output PNP	★ 1512320	CMMO-ST-C5-1-LKP

Festo core product range ★ Generally ready for dispatch from the factory within 24 hours
★ Generally ready for dispatch from the factory within 5 days

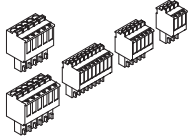
Accessories

Ordering data		Description	Part no.	Type
Assortment of plugs				
	Assortment of plugs for motor cable, encoder cable, power supply, reference switch, safety function STO Additional control cable for I/O interface, see below	☆ 576005	NEKM-C-10 ¹⁾	
	Assortment of plugs for motor cable, encoder cable, power supply, reference switch, safety function STO and IO-Link	☆ 2948940	NEKM-C-14 ¹⁾	

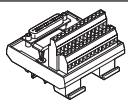
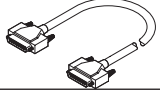
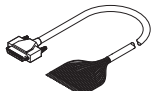
1) Plugs are included in the scope of delivery of the motor controller.

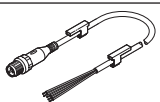

Ordering data – Connection options from I/O interface to controller				
Description		Cable length [m]	Part no.	Type
Connection block				
	Ensures simple and clear wiring. The connection to the motor controller is established via the connecting cable NEBC-S1G25-K-....	–	8001371	NEFC-S1G25-C2W25-S7
Connecting cable				
	Connects the motor controller to the connection block.	1.0	8001374	NEBC-S1G25-K-1.0-N-S1G25
		2.0	8001375	NEBC-S1G25-K-2.0-N-S1G25
		5.0	8001376	NEBC-S1G25-K-5.0-N-S1G25
Control cable				
	Is connected to the motor controller. The other end comprises individual flying leads.	3.2	☆ 8001373	NEBC-S1G25-K-3.2-N-LE25
Plug				
	25-pin Sub-D plug. Each wire can be individually assembled using screw terminals.	–	☆ 8001372	NEFC-S1G25-C2W25-S6

Ordering data – Cables ¹⁾				
Description		Cable length [m]	Part no.	Type
Connecting cable between fieldbus motor CTEU and motor controller CMMO-ST				
	<ul style="list-style-type: none"> Min. bending radius: 75 mm Suitable for energy chains Ambient temperature: –25 ... +70 °C 	1	569840	NEBU-LE5-K-1-M12G5

1) Other line variants available on request.

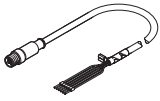
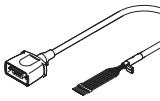
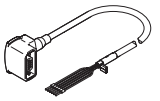
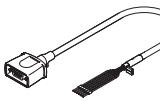
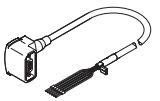
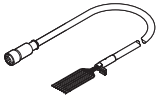

Accessories

Ordering data – Cables ¹⁾					
	For type	Description	Cable length [m]	Part no.	Type
Motor cable					
	EPCO-16 ERMO-12/-16 EMMS-ST-28	Straight plug • Min. bending radius: 62 mm • Suitable for energy chains • Ambient temperature: -40 ... +80 °C	1.5	★ 1449600	NEBM-SM12G8-E-1.5-Q5-LE6
			2.5	★ 1449601	NEBM-SM12G8-E-2.5-Q5-LE6
			5.0	★ 1449602	NEBM-SM12G8-E-5-Q5-LE6
			7.0	★ 1449603	NEBM-SM12G8-E-7-Q5-LE6
			10.0	★ 1449604	NEBM-SM12G8-E-10-Q5-LE6
	EPCO-25/-40 ELGR-35 ERMO-25/-32 EMMS-ST-42/-57	Straight plug • Min. bending radius: 62 mm • Suitable for energy chains • Ambient temperature: -40 ... +80 °C	1.5	★ 1450368	NEBM-S1G9-E-1.5-Q5-LE6
			2.5	★ 1450369	NEBM-S1G9-E-2.5-Q5-LE6
			5.0	★ 1450370	NEBM-S1G9-E-5-Q5-LE6
			7.0	★ 1450371	NEBM-S1G9-E-7-Q5-LE6
			10.0	★ 1450372	NEBM-S1G9-E-10-Q5-LE6
	EPCO-25/-40 ELGR-35 ERMO-25/-32 EMMS-ST-42/-57	Angled plug • Min. bending radius: 62 mm • Suitable for energy chains • Ambient temperature: -40 ... +80 °C	1.5	★ 1450736	NEBM-S1W9-E-1.5-Q5-LE6
			2.5	★ 1450737	NEBM-S1W9-E-2.5-Q5-LE6
			5.0	★ 1450738	NEBM-S1W9-E-5-Q5-LE6
			7.0	★ 1450739	NEBM-S1W9-E-7-Q5-LE6
			10.0	★ 1450740	NEBM-S1W9-E-10-Q5-LE6
	ELGR-45/-55 EMMS-ST-87	Straight plug • Min. bending radius: 80 mm • Suitable for energy chains • Ambient temperature: -40 ... +80 °C	1.5	★ 1450834	NEBM-S1G15-E-1.5-Q7-LE6
			2.5	★ 1450835	NEBM-S1G15-E-2.5-Q7-LE6
			5.0	★ 1450836	NEBM-S1G15-E-5-Q7-LE6
			7.0	★ 1450837	NEBM-S1G15-E-7-Q7-LE6
			10.0	★ 1450838	NEBM-S1G15-E-10-Q7-LE6
	ELGR-45/-55 EMMS-ST-87	Angled plug • Min. bending radius: 80 mm • Suitable for energy chains • Ambient temperature: -40 ... +80 °C	1.5	★ 1450943	NEBM-S1W15-E-1.5-Q7-LE6
			2.5	★ 1450944	NEBM-S1W15-E-2.5-Q7-LE6
			5.0	★ 1450945	NEBM-S1W15-E-5-Q7-LE6
			7.0	★ 1450946	NEBM-S1W15-E-7-Q7-LE6
			10.0	★ 1450947	NEBM-S1W15-E-10-Q7-LE6
Encoder cable					
	EPCO-16/-25/-40 ELGR-35/-45/-55 ERMO-12/-16/-25/-32 EMMS-ST-28/-42/-57/-87	Straight plug • Min. bending radius: 68 mm • Suitable for energy chains • Ambient temperature: -40 ... +80 °C	1.5	★ 1451586	NEBM-M12G8-E-1.5-LE8
			2.5	★ 1451587	NEBM-M12G8-E-2.5-LE8
			5.0	★ 1451588	NEBM-M12G8-E-5-LE8
			7.0	★ 1451589	NEBM-M12G8-E-7-LE8
			10.0	★ 1451590	NEBM-M12G8-E-10-LE8
	EPCO-25/-40 ERMO-25/-32 EMMS-ST-42/-57/-87	Angled plug • Min. bending radius: 68 mm • Suitable for energy chains • Ambient temperature: -40 ... +80 °C	1.5	★ 1451674	NEBM-M12W8-E-1.5-LE8
			2.5	★ 1451675	NEBM-M12W8-E-2.5-LE8
			5.0	★ 1451676	NEBM-M12W8-E-5-LE8
			7.0	★ 1451677	NEBM-M12W8-E-7-LE8
			10.0	★ 1451678	NEBM-M12W8-E-10-LE8

1) Other cable lengths on request.

Festo core product range



Generally ready for dispatch from the factory within 24 hours
Generally ready for dispatch from the factory within 5 days

Festo - Your Partner in Automation



1 Festo Inc.
5300 Explorer Drive
Mississauga, ON L4W 5G4
Canada

Festo Customer Interaction Center
Tel: 1 877 463 3786
Fax: 1 877 393 3786
Email: customer.service.ca@festo.com



2 Festo Pneumatic
Av. Ceylán 3,
Col. Tequesquináhuac
54020 Tlalnepantla,
Estado de México

Multinational Contact Center
01 800 337 8669
ventas.mexico@festo.com



3 Festo Corporation
1377 Motor Parkway
Suite 310
Islandia, NY 11749

Festo Customer Interaction Center
1 800 993 3786
1 800 963 3786
customer.service.us@festo.com



4 Regional Service Center
7777 Columbia Road
Mason, OH 45040

Connect with us



www.festo.com/socialmedia



www.festo.com

Subject to change