

Zaolejovače LOE, konštrukčný rad D

FESTO



Zaolejovače LOE, rad D, kovové

prehľad dodávok jednotiek úpravy vzduchu radu D, kov

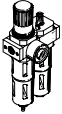
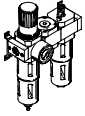
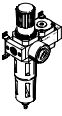
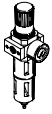
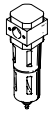
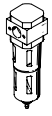
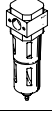
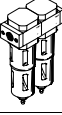
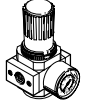

typ	veľkosť	pneumatický prípoj										rozsah regulačného tlaku [bar]			jemnosť filtra [µm]			
		M5	M7	G $\frac{3}{8}$	G $\frac{1}{4}$	G $\frac{3}{8}$	G $\frac{1}{2}$	G $\frac{3}{4}$	G1	QS4	QS6	0,5 ...	0,5 ...	2,5 ...	0,01	1	5	40
jednotky úpravy vzduchu																		
FRC/FRCS 	Micro	■	■	■	-	-	-	-	-	■	■	■	-	-	-	-	■	-
	Mini	-	-	■	■	■	-	-	-	-	-	■	■	-	-	-	■	■
	Midi	-	-	-	■	■	■	■	-	-	-	■	■	-	-	-	■	■
	Maxi	-	-	-	-	-	■	■	■	-	-	■	■	-	-	-	■	■
kombinácie jednotiek úpravy vzduchu																		
FRC-K 	Micro	-	-	-	-	-	-	-	-	-	-	-	-	-	-	-	-	
	Mini	-	-	■	■	-	-	-	-	-	-	■	■	-	-	-	-	■
	Midi	-	-	-	■	■	■	-	-	-	-	■	■	-	-	-	-	■
	Maxi	-	-	-	-	-	■	■	-	-	-	■	■	-	-	-	-	■
LFR-K LFRS-K 	Micro	-	-	-	-	-	-	-	-	-	-	-	-	-	-	-	-	
	Mini	-	-	■	■	-	-	-	-	-	-	■	■	-	-	-	-	■
	Midi	-	-	-	■	■	■	-	-	-	-	■	■	-	-	-	-	■
	Maxi	-	-	-	-	-	■	■	-	-	-	■	■	-	-	-	-	■
jednotlivé zariadenia																		
filtre s redukčným ventilom LFR/LFRS 	Micro	■	■	■	-	-	-	-	-	■	■	■	-	-	-	-	■	-
	Mini	-	-	■	■	■	-	-	-	-	-	■	■	-	-	-	■	■
	Midi	-	-	-	■	■	■	■	-	-	-	■	■	-	-	-	■	■
	Maxi	-	-	-	-	-	■	■	■	-	-	■	■	-	-	-	■	■
filter LF 	Micro	■	■	■	-	-	-	-	-	■	■	-	-	-	-	-	■	-
	Mini	-	-	■	■	■	-	-	-	-	-	-	-	-	-	-	■	■
	Midi	-	-	-	■	■	■	■	-	-	-	-	-	-	-	-	■	■
	Maxi	-	-	-	-	-	■	■	■	-	-	-	-	-	-	-	■	■
jemný a veľmi jemný filter LFMA/LFMB 	Micro	-	-	-	-	-	-	-	-	-	-	-	-	-	-	-	-	
	Mini	-	-	■	■	■	-	-	-	-	-	-	-	■	■	-	-	-
	Midi	-	-	-	■	■	■	■	-	-	-	-	-	■	■	-	-	-
	Maxi	-	-	-	-	-	■	■	■	-	-	-	-	■	■	-	-	-
filter s aktívnym uhlím LFX 	Micro	-	-	-	-	-	-	-	-	-	-	-	-	-	-	-	-	
	Mini	-	-	■	■	■	-	-	-	-	-	-	-	-	-	-	-	-
	Midi	-	-	-	■	■	■	■	-	-	-	-	-	-	-	-	-	-
	Maxi	-	-	-	-	-	■	■	■	-	-	-	-	-	-	-	-	-
kombinácie filtrov LFMBA 	Micro	-	-	-	-	-	-	-	-	-	-	-	-	-	-	-	-	
	Mini	-	-	■	■	■	-	-	-	-	-	-	-	■	■	-	-	-
	Midi	-	-	-	■	■	■	■	-	-	-	-	-	■	■	-	-	-
	Maxi	-	-	-	-	-	■	■	■	-	-	-	-	■	■	-	-	-
tlakové regulačné ventily LR/LRS 	Micro	■	■	■	-	-	-	-	-	■	■	■	-	-	-	-	-	-
	Mini	-	-	■	■	■	-	-	-	-	-	■	■	-	-	-	-	-
	Midi	-	-	-	■	■	■	■	-	-	-	■	■	-	-	-	-	-
	Maxi	-	-	-	-	-	■	■	■	-	-	■	■	-	-	-	-	-

Zaolejovače LOE, rad D, kovové

prehľad dodávok jednotiek úpravy vzduchu radu D, kov









typ	veľkosť	ochrana nádobiek		odlučovanie kondenzátu			indikácia tlaku		zabezpečenie ovládania		napájacie napätie			možnosti			→ strana/ internet
		kovový ochranný kôš	plastová nádobka	ručné, otáčaním	poloautomatické	plnoautomatické	s manometrom	bez manometra	otočný ovládač s aretáciou	otočný ovládač s integrovaným zámkom	24 V DC	110 V AC	230 V AC	priamo ovládaný tlakový regulačný ventil s integrovanou funkciou spätného prúdenia	nepriamo ovládaný tlakový regulačný ventil s integrovanou funkciou spätného prúdenia	indikácia tlakovej difference	
jednotky úpravy vzduchu																	
FRC/FRCS	Micro	-	■	■	■	-	■	■	■	-	-	-	-	-	-	-	frc
	Mini	■	-	■	-	■	■	■	■	■	-	-	-	-	-	-	
	Midi	■	-	■	-	■	■	■	■	■	-	-	-	-	-	-	
	Maxi	■	-	■	-	■	■	■	■	■	-	-	-	■	■	-	
kombinácie jednotiek úpravy vzduchu																	
FRC-K	Micro	-															frc
	Mini	■	-	■	-	■	■	-	■	-	■	-	-	-	-	-	
	Midi	■	-	■	-	■	■	-	■	-	■	-	-	-	-	-	
	Maxi	■	-	■	-	■	■	-	■	-	■	-	-	■	■	-	
LFR-K LFRS-K	Micro	-															lfr
	Mini	■	-	■	-	■	■	-	■	■	■	-	-	-	-	-	
	Midi	■	-	■	-	■	■	-	■	■	■	-	-	-	-	-	
	Maxi	■	-	■	-	■	■	-	■	■	■	-	-	■	■	-	
jednotlivé zariadenia																	
filtre s redukčným ventilom LFR/LFRS	Micro	-	■	■	■	-	■	■	■	-	-	-	-	-	-	-	lfr
	Mini	■	-	■	-	■	■	■	■	■	-	-	-	-	-	-	
	Midi	■	-	■	-	■	■	■	■	■	-	-	-	-	-	-	
	Maxi	■	-	■	-	■	■	■	■	■	-	-	-	■	■	-	
filter LF	Micro	-	■	■	■	-	-	-	-	-	-	-	-	-	-	-	lf
	Mini	■	-	■	-	■	-	-	-	-	-	-	-	-	-	-	
	Midi	■	-	■	-	■	-	-	-	-	-	-	-	-	-	-	
	Maxi	■	-	■	-	■	-	-	-	-	-	-	-	-	-	-	
jemný a veľmi jemný filter LFMA/LFMB	Micro	-															lfma, lfmb
	Mini	■	-	■	-	■	-	-	-	-	-	-	-	-	-	■	
	Midi	■	-	■	-	■	-	-	-	-	-	-	-	-	-	■	
	Maxi	■	-	■	-	■	-	-	-	-	-	-	-	-	-	■	
filter s aktívnym uhlím LFX	Micro	-															lfx
	Mini	■	-	-	-	-	-	-	-	-	-	-	-	-	-	-	
	Midi	■	-	-	-	-	-	-	-	-	-	-	-	-	-	-	
	Maxi	■	-	-	-	-	-	-	-	-	-	-	-	-	-	-	
kombinácie filtrov LFMBA	Micro	-															lfmba
	Mini	■	-	■	-	■	-	-	-	-	-	-	-	-	-	■	
	Midi	■	-	■	-	■	-	-	-	-	-	-	-	-	-	■	
	Maxi	■	-	■	-	■	-	-	-	-	-	-	-	-	-	■	
tlakové regulačné ventily LR/LRS	Micro	-	-	-	-	-	■	■	■	-	-	-	-	-	-	-	lr
	Mini	-	-	-	-	-	■	■	■	■	-	-	-	■	-	-	
	Midi	-	-	-	-	-	■	■	■	■	-	-	-	■	-	-	
	Maxi	-	-	-	-	-	■	■	■	■	-	-	-	■	■	-	

Zaolejovače LOE, rad D, kovové

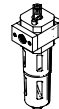
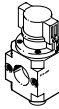
prehľad dodávok jednotiek úpravy vzduchu radu D, kov

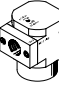
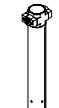
FESTO

typ	velkosť	pneumatické prípoj										rozsah regulovateľného tlaku [bar]		
		M5	M7	G1/8	G1/4	G3/8	G1/2	G3/4	G1	QS4	QS6	0,5 ... 7	0,5 ... 12	
jednotlivé zariadenia														
tlakové regulačné ventily LRB/LRBS		Micro	-											
		Mini	-	-	-	■	-	-	-	-	-	-	■	■
		Midi	-	-	-	-	■	-	-	-	-	-	■	■
		Maxi	-											
batérie tlakových regulačných ventilov LRB-K		Micro	-											
		Mini	-	-	-	■	■	-	-	-	-	-	■	■
		Midi	-	-	-	-	■	■	-	-	-	-	■	■
		Maxi	-											
zaolejovač LOE		Micro	■	■	■	-	-	-	-	-	■	■	-	-
		Mini	-	-	■	■	■	-	-	-	-	-	-	-
		Midi	-	-	-	■	■	■	■	-	-	-	-	-
		Maxi	-	-	-	-	-	■	■	■	-	-	-	-
zapínacie ventily HE		Micro	-											
		Mini	-	-	■	■	■	-	-	-	-	-	-	-
		Midi	-	-	-	■	■	■	■	-	-	-	-	-
		Maxi	-	-	-	-	-	■	■	■	-	-	-	-
zapínacie ventily HEE		Micro	-											
		Mini	-	-	■	■	■	-	-	-	-	-	-	-
		Midi	-	-	-	■	■	■	■	-	-	-	-	-
		Maxi	-	-	-	-	-	■	■	■	-	-	-	-
zapínacie ventily HEP		Micro	-											
		Mini	-	-	■	■	■	-	-	-	-	-	-	-
		Midi	-	-	-	■	■	■	■	-	-	-	-	-
		Maxi	-	-	-	-	-	■	■	■	-	-	-	-
pomalo nábehové ventily HEL		Micro	-											
		Mini	-	-	■	■	■	-	-	-	-	-	-	-
		Midi	-	-	-	■	■	■	■	-	-	-	-	-
		Maxi	-	-	-	-	-	■	■	■	-	-	-	-
membránový sušič vzduchu LDM1		Micro	-											
		Mini	-											
		Midi	-											
		Maxi	-	-	-	-	-	■	■	■	-	-	-	-
rozbočovacie moduly FRM		Micro	-											
		Mini	-	-	■	■	■	-	-	-	-	-	-	-
		Midi	-	-	-	■	■	■	■	-	-	-	-	-
		Maxi	-	-	-	-	-	■	■	■	-	-	-	-
rozdeľovací blok FRZ		Micro	-											
		Mini	-											
		Midi	-											
		Maxi	-											

Zaolejovače LOE, rad D, kovové

prehľad dodávok jednotiek úpravy vzduchu radu D, kov



typ	veľkosť	ochrana nádobiek		indikácia tlaku		zabezpečenie ovládania		napájacie napätie			možnosti		→ strana/ internet
		kovový ochranný kôš	plastová nádobka	s manometrom	bez manometra	otočný ovládač s aretáciou	otočný ovládač s integrovaným zámkom	24 V DC	110 V AC	230 V AC	spätný ventil	tlakový spínač	
jednotlivé zariadenia													
tlakové regulačné ventily LRB/LRBS	Micro	-	-	-	■	■	■	-	-	-	-	-	lrb
	Mini	-	-	-	■	■	■	-	-	-	-	-	
	Midi	-	-	-	■	■	■	-	-	-	-	-	
	Maxi	-	-	-	■	■	■	-	-	-	-	-	
batérie tlakových regulačných ventilov	Micro	-	-	-	■	■	-	-	-	-	-	-	lrb
	Mini	-	-	-	■	■	-	-	-	-	-	-	
	Midi	-	-	-	■	■	-	-	-	-	-	-	
	Maxi	-	-	-	■	■	-	-	-	-	-	-	
zaolejovač LOE	Micro	-	■	-	■	-	-	-	-	-	-	-	6
	Mini	■	-	-	■	-	-	-	-	-	-	-	
	Midi	■	-	-	■	-	-	-	-	-	-	-	
	Maxi	■	-	-	■	-	-	-	-	-	-	-	
zapínacie ventily HE	Micro	-	-	-	■	■	-	-	-	-	-	-	he
	Mini	-	-	-	■	■	-	-	-	-	-	-	
	Midi	-	-	-	■	■	-	-	-	-	-	-	
	Maxi	-	-	-	■	■	-	-	-	-	-	-	
zapínacie ventily HEE	Micro	-	-	-	■	-	-	■	■	■	-	-	hee
	Mini	-	-	-	■	-	-	■	■	■	-	-	
	Midi	-	-	-	■	-	-	■	■	■	-	-	
	Maxi	-	-	-	■	-	-	■	■	■	-	-	
zapínacie ventily HEP	Micro	-	-	-	■	-	-	-	-	-	-	-	hep
	Mini	-	-	-	■	-	-	-	-	-	-	-	
	Midi	-	-	-	■	-	-	-	-	-	-	-	
	Maxi	-	-	-	■	-	-	-	-	-	-	-	
pomalo nábehové ventily HEL	Micro	-	-	-	■	-	-	-	-	-	-	-	hel
	Mini	-	-	-	■	-	-	-	-	-	-	-	
	Midi	-	-	-	■	-	-	-	-	-	-	-	
	Maxi	-	-	-	■	-	-	-	-	-	-	-	
membránový sušič vzduchu LDM1	Micro	-	-	-	-	-	-	-	-	-	-	-	ldm1
	Mini	-	-	-	-	-	-	-	-	-	-	-	
	Midi	-	-	-	-	-	-	-	-	-	-	-	
	Maxi	■	-	-	■	-	-	-	-	-	-	-	
rozbočovacie moduly FRM	Micro	-	-	-	■	-	-	-	-	-	■	■	frm
	Mini	-	-	-	■	-	-	-	-	-	■	■	
	Midi	-	-	-	■	-	-	-	-	-	■	■	
	Maxi	-	-	-	■	-	-	-	-	-	■	■	
rozdeľovací blok FRZ	Micro	-	-	-	■	-	-	-	-	-	-	-	frz
	Mini	-	-	-	■	-	-	-	-	-	-	-	
	Midi	-	-	-	■	-	-	-	-	-	-	-	
	Maxi	-	-	-	■	-	-	-	-	-	-	-	

Zaolejovače LOE, rad D, kovové

prehľad príslušenstva

FESTO

Micro

samostatné zariadenie s pripojovacími doskami, pripojovací rozmer G $\frac{1}{8}$, QS4 alebo QS6

samostatné zariadenie bez pripojovacích dosiek, pre kombináciu jednotiek úpravy vzduchu, pripojovací rozmer M5 alebo M7 v telese

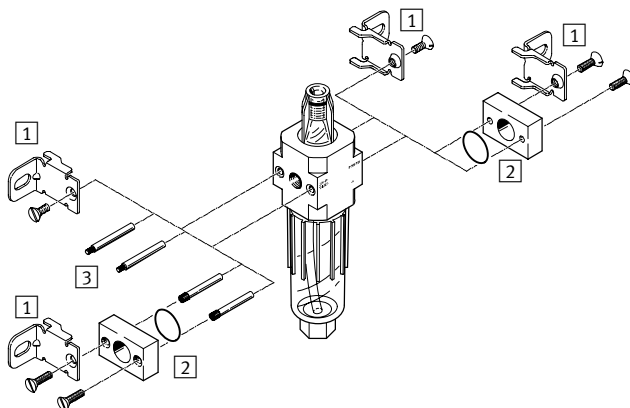
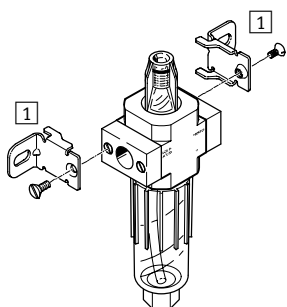

Upevňovacie prvky a príslušenstvo	samostatné zariadenie		kombinácia		→ strana/internet
	s pripojovacími doskami	bez pripojovacích dosiek	s pripojovacími doskami	bez pripojovacích dosiek	
1 upevňovací uholník HFOE	■	■	■	■	hfoe-d
2 pripojovacia sada PBL	-	■	-	■	pbl
3 čap so závitom FRB	-	-	■	■	frb-d

Mini/Midi/Maxi

samostatné zariadenie s pripojovacími doskami

samostatné zariadenie bez pripojovacích dosiek, pre kombináciu jednotiek úpravy vzduchu

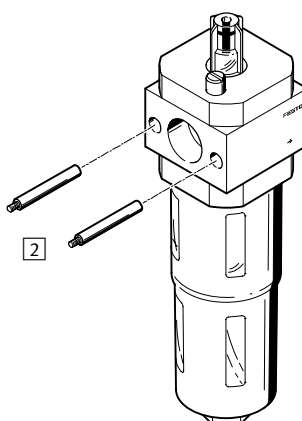
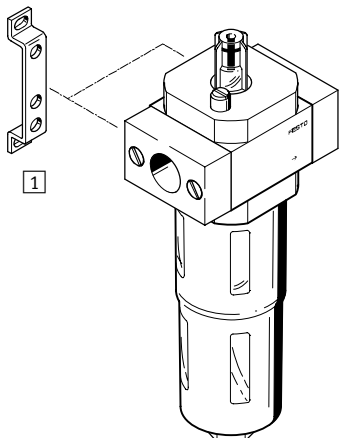

Upevňovacie prvky a príslušenstvo	samostatné zariadenie		kombinácia		→ strana/internet
	s pripojovacími doskami	bez pripojovacích dosiek	s pripojovacími doskami	bez pripojovacích dosiek	
1 upevňovací uholník HFOE	■	-	■	-	hfoe-d
2 čap so závitom (obsiahnutý v dodávke) FRB	-	-	■	■	frb-d

Zaolejovače LOE, rad D, kovové

legenda k typovému označeniu

FESTO

LOE		-	1/4	-	D	-	MIDI
základná funkcia							
LOE	zaolejovače						
pneumatický prípoj							
MINI/MIDI/MAXI							
	bez pripojovacích dosiek						
MICRO							
M5	vnútorný závit M5						
M7	vnútorný závit M7						
1/8	pripojovacie dosky so závitom G1/8						
QS4	pripojovacie dosky s nástrčným prípojom QS-4						
QS6	pripojovacie dosky s nástrčným prípojom QS-6						
MINI							
1/8	pripojovacie dosky so závitom G1/8						
1/4	pripojovacie dosky so závitom G1/4						
3/8	pripojovacie dosky so závitom G3/8						
MIDI							
1/4	pripojovacie dosky so závitom G1/4						
3/8	pripojovacie dosky so závitom G3/8						
1/2	pripojovacie dosky so závitom G1/2						
3/4	pripojovacie dosky so závitom G3/4						
MAXI							
1/2	pripojovacie dosky so závitom G1/2						
3/4	pripojovacie dosky so závitom G3/4						
1	pripojovacie dosky so závitom G1						
rad							
D	rad						
veľkosť							
MICRO	rozmer rastra 25 mm (bez pripojovacích dosiek)						
MINI	rozmer rastra 40 mm (bez pripojovacích dosiek)						
MIDI	rozmer rastra 55 mm (bez pripojovacích dosiek)						
MAXI	rozmer rastra 66 mm (bez pripojovacích dosiek)						

Zaolejovače LOE, rad D, kovové

údajový list

FESTO

funkcia

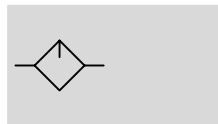

-  - **prietok**
160 ... 9 000 l/min
-  - **teplotný rozsah**
-10 ... +60 °C
-  - **prevádzkový tlak**
0 ... 16 bar



Proporcionálny zaolejovač privádza do stlačeného vzduchu presne nastavené množstvo oleja. Pokles tlaku, ku ktorému dochádza pri prietoku cez Venturiho dýzu, sa využíva k preprave oleja zo zásobníka až ku krytu pre odkvapkávanie.

Odtiaľ je kvapka oleja odvádzaná do vzduchového kanálika, tesne za proporcionálnym ventilom, kde je rozprášená. Podiel olejovej hmly je úmerný množstvu pretekajúceho vzduchu.

- proporcionálny zaolejovač s presným dávkovaním oleja
- zabráňuje opotrebovaniu veľmi namáhaných pohonov
- vysoká priepustnosť
- jednoduché a rýchle doplnenie oleja
- robustné kovové teleso
- priehľadná nádobka na olej s kovovým ochranným košom

Pre zariadenia Festo odporúčame nasledujúce oleje: rozsah viskozity podľa ISO 3448, ISO trieda VG 32 32 mm²/s (= cSt) pri 40 °C

- Špeciálny olej Festo → 14
- ARAL Vitam GF 32
- BP Energol HLP 32
- Esso Nuto H 32
- Mobil DTE 24
- Shell Tellus Oil DO 32

Všeobecné technické údaje																		
veľkosť	Micro				Mini				Midi				Maxi					
pneumatický prípoj 1, 2	M5 ¹⁾	M7 ¹⁾	G1/8	QS4	QS6	G1/8	G1/4	G3/8	- ²⁾	G1/4	G3/8	G1/2	G3/4	- ²⁾	G1/2	G3/4	G1	- ²⁾
konštrukcia	proporcionálny štandardný zaolejovač vytvárajúci olejovú hmlu																	
spôsob upevnenia	s príslušenstvom																	
	zapojenie do vedenia																	
montážna poloha	zvislá ±5°																	
trieda čistoty výstupného vzduchu	stlačený vzduch podľa ISO 8573-1:2010 [7:4:4]																	
	inertné plyny																	
ochrana nádobiek	-				kovový ochranný kôš													
minimálny prietok pre funkciu zaolejovača [l/min]	3				3				8				10					
max. množstvo oleja [cm ³]	6,5				45				110				190					

1) vnútorný závit

2) bez pripojovacích dosiek

- | - Upozornenie: Tento výrobok zodpovedá ISO 1179-1 a ISO 228-1.

Nominálny prietok ¹⁾ q _{nN} [l/min]					
veľkosť	Micro				
pneumatický prípoj 1, 2	M5	M7	G1/8	QS-4	QS-6
LOE	200	430	410	160	330

1) merané pri p₁ = 6 bar a Δp = 1 bar

Nominálny prietok q _{nN} ¹⁾ [l/min]										
veľkosť	Mini			Midi				Maxi		
pneumatický prípoj 1, 2	G1/8	G1/4	G3/8	G1/4	G3/8	G1/2	G3/4	G1/2	G3/4	G1
LOE	1300	2300	2700	2800	5500	6100	6300	8300	8400	9000

1) merané pri p₁ = 6 bar a Δp = 1 bar

Zaolejovače LOE, rad D, kovové

údajový list

FESTO

Prevádzkové podmienky a podmienky okolia				
veľkosť	Micro	Mini	Midi	Maxi
prevádzkový tlak [bar]	1 ... 10	0 ... 16		
prevádzkové médium	stlačený vzduch podľa ISO 8573-1:2010 [7:4:4] inertné plyny			
upozornenie pre prevádzkové/ riadiace médium	prevádzka s mazaním možná (potrebné pri ďalšej prevádzke)			
teplota okolia [°C]	-10 ... +60			
teplota média [°C]	-10 ... +60			
skladovacia teplota [°C]	-10 ... +60			
odolnosť proti korózii KBK ¹⁾	2			
osvedčenie	spoločnosť Germanischer Lloyd			

1) Trieda odolnosti proti korózii 2 podľa normy Festo 940 070:

Konštrukčne diely s miernymi narokmi na odolnosť proti korózii. Vonkajšie viditeľne časti s požiadavkami predovšetkým na vzhľad povrchu, ktorý je vystavený priamemu kontaktu s okolitou pre priemysel bežnou atmosférou prípadne kontaktu s médiami, ako su chladiace látky a maziva.

Hmotnosti [g]						
veľkosť	Micro		Mini	Midi	Maxi	
	vnútorný závit	pripojovacia doska			pripojenie G1½, G¾	pripojenie G1
LOE	39	59	270	630	1100	1200

Materiály

funkčný rez

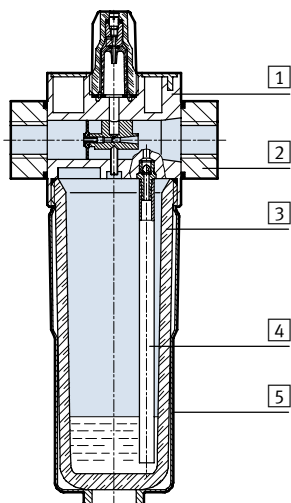

veľkosť	Micro	Mini/Midi/Maxi
1 teleso	hliníkový tlakový odliatok	zinková tlaková liatina/hliník
2 pripojovacie dosky	hliníková tvárna zliatina	zinková tlaková liatina/hliník
3 nádoba	PC	
4 trubka	PE	
5 kovový ochranný kôš	-	hliníková tvárna zliatina
- tesnenia	NBR	
poznámka o materiáli	v zmysle RoHS	

Zaolejovače LOE, rad D, kovové

údajový list



Normálny prietok q_n v závislosti od tlakovej diferencie Δp_{1-2}

LOE-M5-D-MICRO

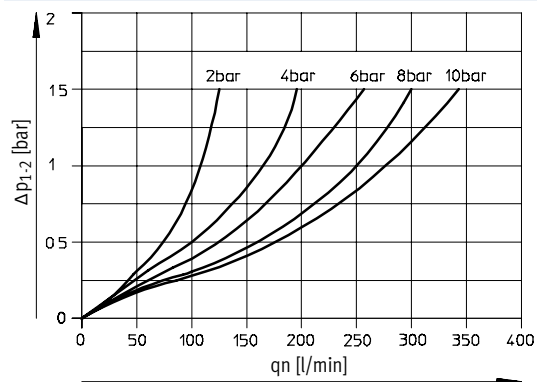

LOE-M7-D-MICRO B

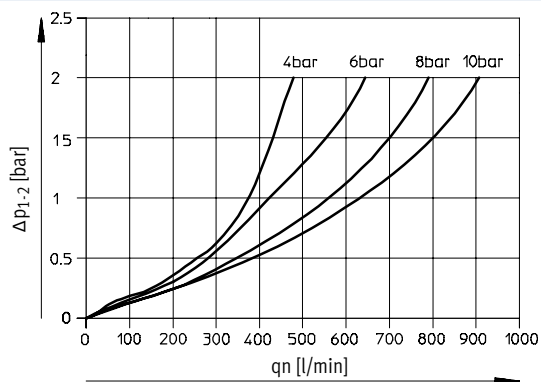

LOE-1/8-D-MICRO

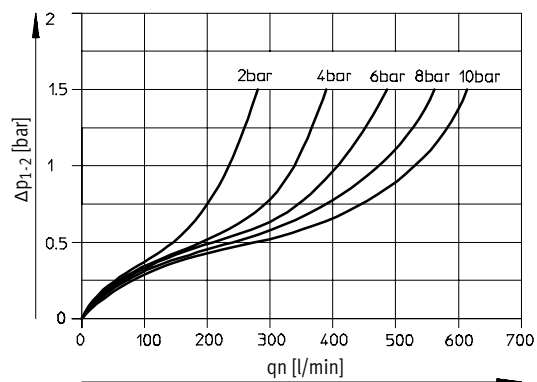

LOE-QS4-D-MICRO

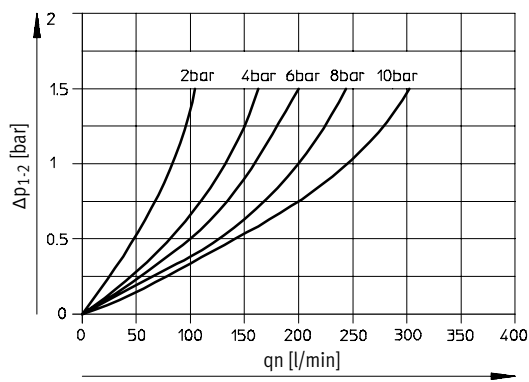

LOE-QS6-D-MICRO

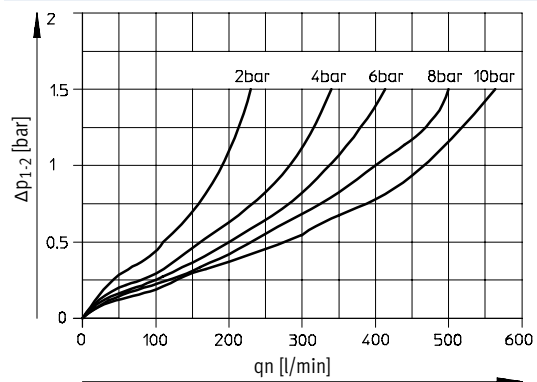

Zaolejšovače LOE, rad D, kovové

údajový list

Normálny prietok q_n v závislosti od tlakovej diferencie Δp_{1-2}

LOE-1/4-D-MINI

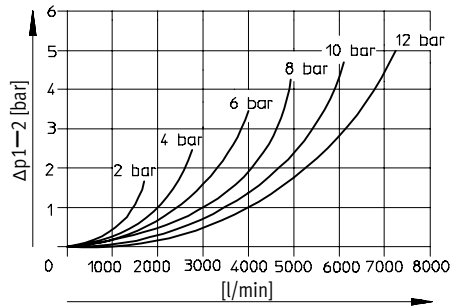

LOE-1/2-D-MIDI

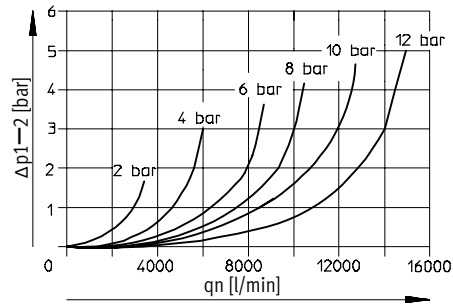

LOE-1-D-MAXI

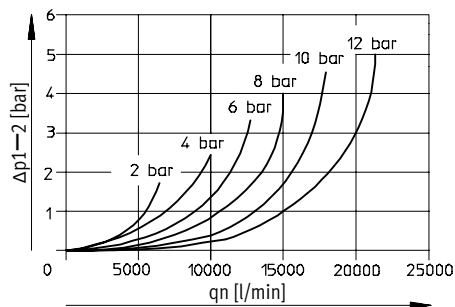

Rozmery – micro

sťahovanie CAD modelov → www.festo.sk

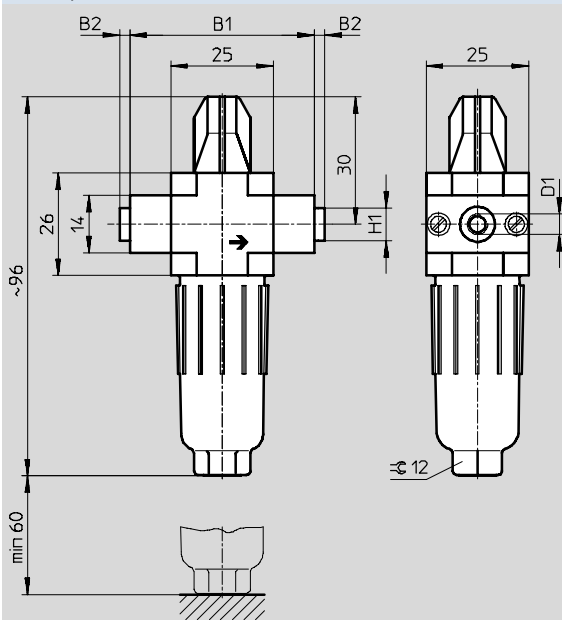

→ smer prietoku

typ	B1	B2	D1	H1
LOE-M5-D-MICRO	25	-	M5	-
LOE-M7-D-MICRO B			M7	
LOE-1/8-D-MICRO			G1/8	
LOE-QS4-D-MICRO	45	~2,5	QS-4	~8
LOE-QS6-D-MICRO			QS-6	~10

UPOZORNENIE: Tento výrobok zodpovedá ISO 1179-1 a ISO 228-1.

Zaolejovače LOE, rad D, kovové

údajový list

FESTO

Rozmery – Mini/Midi/Maxi

sťahovanie CAD modelov → www.festo.sk

pripojovacie dosky so závitmi

bez pripojovacích dosiek

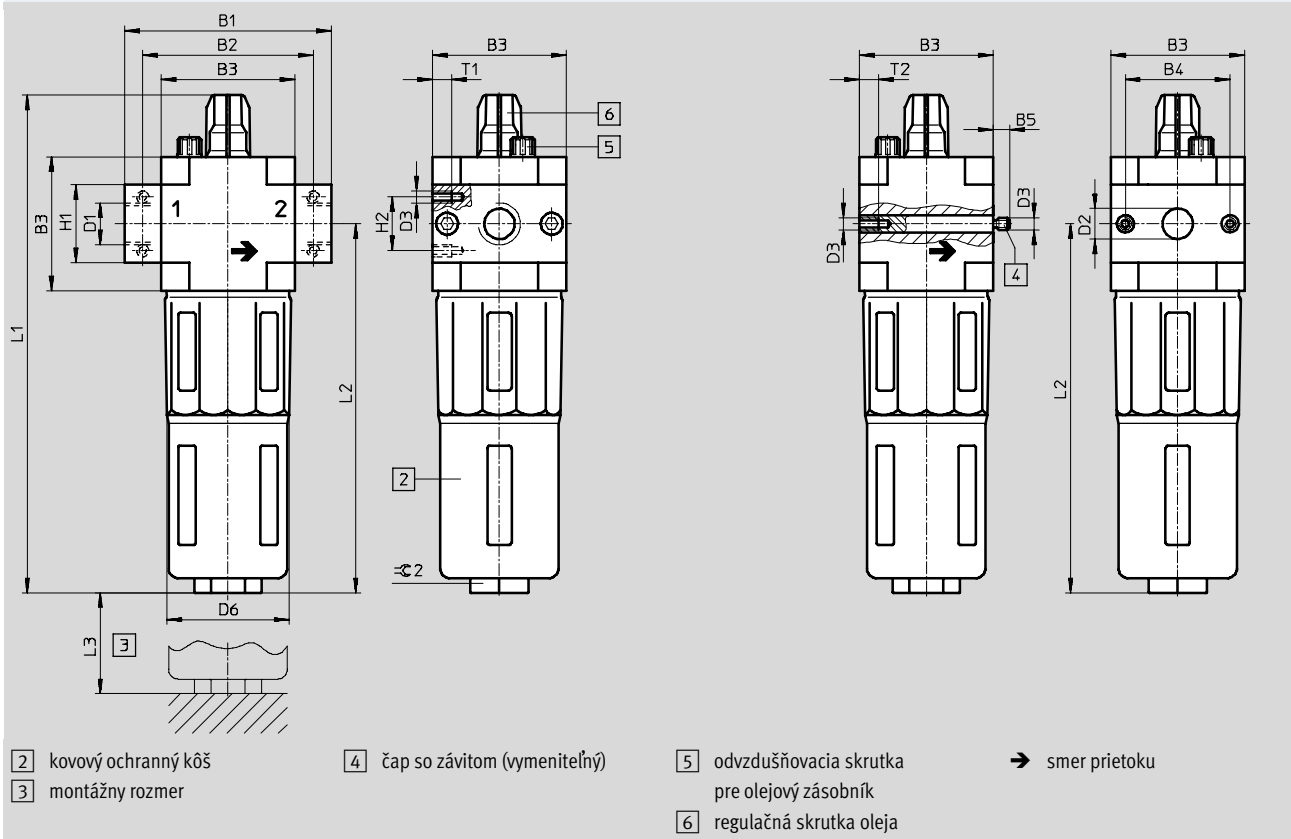

typ	B1	B2	B3	B4	B5	D1	D2 Ø	D3	D6 Ø	H1	H2	L1	L2	L3	T1	T2	≈ 2
Mini																	
LOE-1/8-D-MINI	64	52	40	30	-	G1/8	-	M4	38	20	11	169	124	100	7	-	22
LOE-1/4-D-MINI						G1/4											
LOE-3/8-D-MINI	70	-	-	-	5,8	G3/8	11	-	-	-	-	-	-	-	-	10	-
LOE-D-MINI						-											
Midi																	
LOE-1/4-D-MIDI	85	70	55	43	-	G1/4	-	M5	52	32	22	204	151	120	8	-	24
LOE-3/8-D-MIDI						G3/8											
LOE-1/2-D-MIDI						G1/2											
LOE-3/4-D-MIDI						G3/4											
LOE-D-MIDI	-	-	-	-	6,8	-	24	-	-	-	-	-	-	-	-	11	-
Maxi																	
LOE-1/2-D-MAXI	96	80	66	46	-	G1/2	-	M5	65	32	22	228	170	150	8	-	24
LOE-3/4-D-MAXI						G3/4											
LOE-1-D-MAXI	116	91	-	-	-	G1	-	-	-	40	-	-	-	-	-	11	-
LOE-D-MAXI	-	-	-	-	6,8	-	30	-	-	-	-	-	-	-	-	11	-

UPOZORNENIE: Tento výrobok zodpovedá ISO 1179-1 a ISO 228-1.

Zaolejovače LOE, rad D, kovové

údajový list

FESTO

Typové označenie – Micro			
veľkosť	prípoj	č. dielu	typ
vnútorný závit			
Micro	M5	526309	LOE-M5-D-MICRO
	M7	534188	LOE-M7-D-MICRO-B
prípojovacie dosky so závitmi			
Micro	G $\frac{1}{8}$	526310	LOE- $\frac{1}{8}$ -D-MICRO
prípojovacie dosky s nástrčným prípojom			
Micro	QS-4	526313	LOE-QS4-D-MICRO
	QS-6	526314	LOE-QS6-D-MICRO

Typové označenie – Mini/Midi/Maxi			
veľkosť	prípoj	č. dielu	typ
bez prípojovacích dosiek			
Mini	–	192575	LOE-D-MINI
Midi	–	192576	LOE-D-MIDI
Maxi	–	192577	LOE-D-MAXI
prípojovacie dosky so závitmi			
Mini	G $\frac{1}{8}$	159620	LOE- $\frac{1}{8}$ -D-MINI
	G $\frac{1}{4}$	159621	LOE- $\frac{1}{4}$ -D-MINI
	G $\frac{3}{8}$	162680	LOE- $\frac{3}{8}$ -D-MINI
Midi	G $\frac{1}{4}$	186479	LOE- $\frac{1}{4}$ -D-MIDI
	G $\frac{3}{8}$	159586	LOE- $\frac{3}{8}$ -D-MIDI
	G $\frac{1}{2}$	159587	LOE- $\frac{1}{2}$ -D-MIDI
	G $\frac{3}{4}$	162681	LOE- $\frac{3}{4}$ -D-MIDI
Maxi	G $\frac{1}{2}$	186480	LOE- $\frac{1}{2}$ -D-MAXI
	G $\frac{3}{4}$	159622	LOE- $\frac{3}{4}$ -D-MAXI
	G1	159623	LOE-1-D-MAXI

Zaolejovače LOE, konštrukčný rad D

príslušenstvo

FESTO

Špeciálny olej



Typové označenie		
rozsah dodávky	č. dielu	typ
1 liter	152811	OFSW-32