



- Pogon in vodilo v enem ohišju
- Robustne in natančne
- Prezemanje visokih momentov in prečnih sil
- Raznolikost variant

Vodilne enote DFM/DFM-B

Značilnosti

FESTO

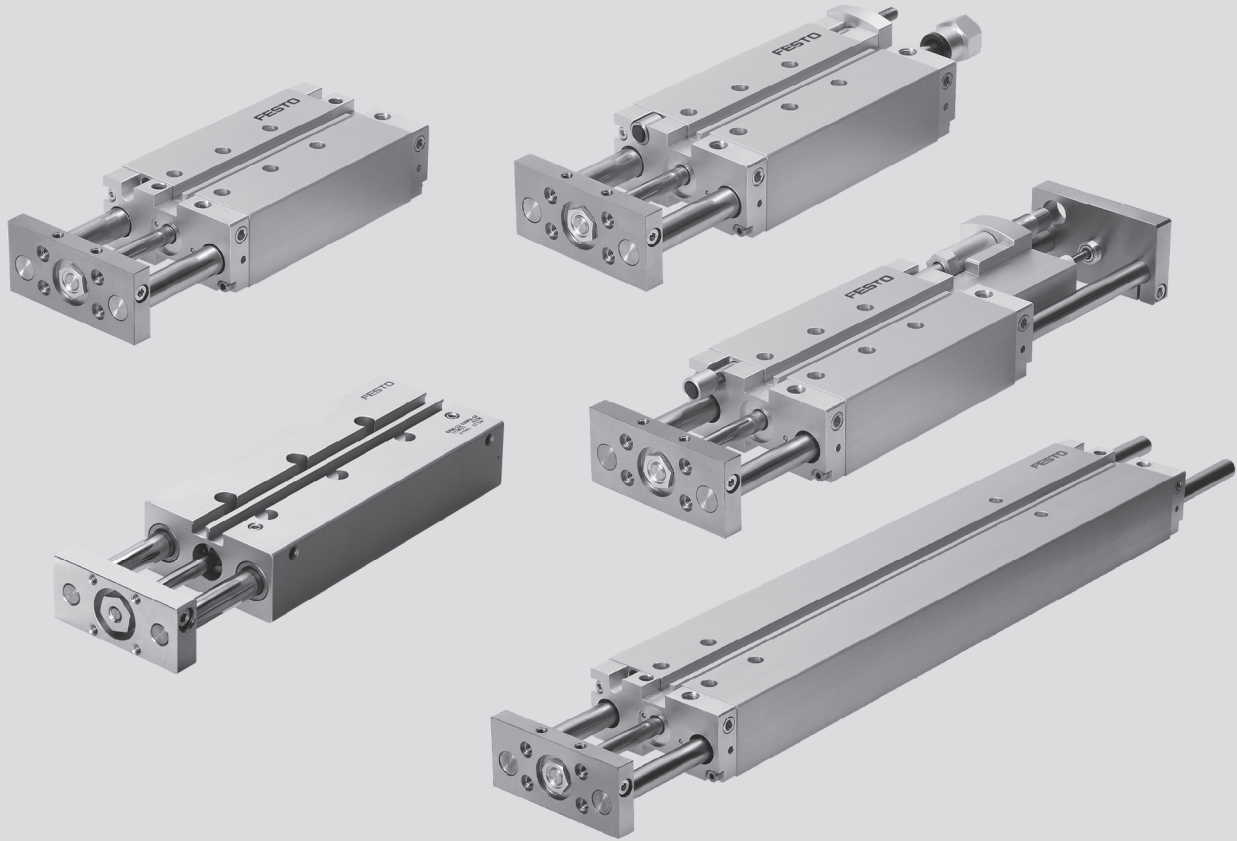

Pogon in vodilo v enem ohišju

- Minimirana potreba po prostoru
- Minimalni montažni čas
- Spremenljiv priključek za stisnjen zrak
- različne možnosti pritrditve

Robustni in natančni

- Visoka varnost pred zasukom
- Visoka togost
- brez vzdrževanja

Prevzemanje visokih momentov in prečnih sil

- Z drsnimi vodili:
Zaradi velikega premera vodilnih drogov in štirih drsnih puš nudi visoko togost.
- S krogličnimi vodili:
Za gibanja pri momentni obremenitvi.

Raznolikost variant

- Z nastavljivim končnim položajem
- Z blažilnikom
- Izvedba z dolgim gibom
- S pnevmatičnim dušenjem v končnih legah PPV

Vodilne enote DFM/DFM-B

Značilnosti

FESTO

Uporaba v transportni tehniki

Dviganje

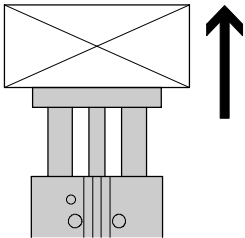

Potiskanje

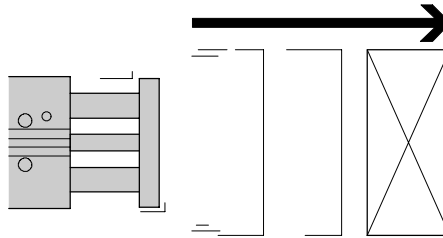

Zaustavljanje

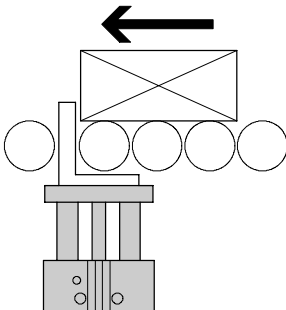

Zaustavljanje s kotnikom prislona

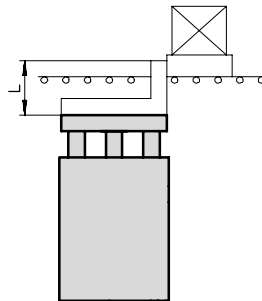

Priporoča se uporaba blažilnika na nosilcu obdelovanca!

Možnosti pritrditve

Plosko od zgoraj

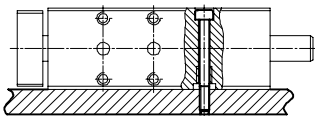

Plosko od spodaj

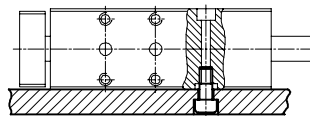

Stransko od zgoraj

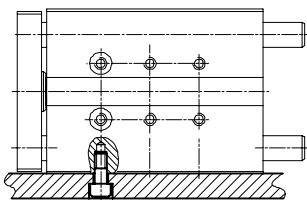

Čelno

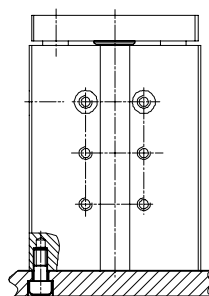

Vodilne enote DFM/DFM-B

FESTO

Pregled dobav

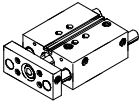
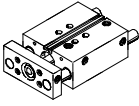
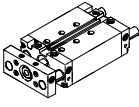
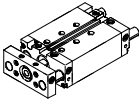
Funkcija	Izvedba	Tip	Ø bata [mm]	Gib [mm]	
Dvosmerni	DFM osnovni tip s krogličnimi vodili				
		DFM Enostranska batnica	12, 16	10, 20, 25, 30, 40, 50, 80, 100	10 ... 100
			20, 25	20, 25, 30, 40, 50, 80, 100	20 ... 100
			32	20, 25, 30, 40, 50, 80, 100, 125, 160, 200	20 ... 200
			40, 50, 63, 80, 100	25, 50, 80, 100, 125, 160, 200	25 ... 200
	DFM osnovni tip z drsnimi vodili				
		DFM Enostranska batnica	12, 16	10, 20, 25, 30, 40, 50, 80, 100	10 ... 100
			20, 25	20, 25, 30, 40, 50, 80, 100	20 ... 100
			32	20, 25, 30, 40, 50, 80, 100, 125, 160, 200	20 ... 200
			40, 50, 63, 80, 100	25, 50, 80, 100, 125, 160, 200	25 ... 200
	DFM-B s krogličnimi vodili				
		DFM-B Enostranska batnica	12, 16	10, 20, 25, 30, 40, 50, 80, 100, 125, 160, 200	10 ... 200
			20, 25, 32	20, 25, 30, 40, 50, 80, 100, 125, 160, 200, 250, 320, 400	20 ... 400
			40, 50, 63	25, 50, 80, 100, 125, 160, 200, 250, 320, 400	25 ... 400
	DFM-B z drsnimi vodili				
		DFM-B Enostranska batnica	12, 16	10, 20, 25, 30, 40, 50, 80, 100, 125, 160, 200	10 ... 200
			20, 25, 32	20, 25, 30, 40, 50, 80, 100, 125, 160, 200, 250, 320, 400	20 ... 400
			40, 50, 63	25, 50, 80, 100, 125, 160, 200, 250, 320, 400	25 ... 400

Vodilne enote DFM/DFM-B

Pregled dobav

FESTO

Tip	Zaznavanje položaja	Dušenje			Fina nastavitev končne lege		→ Stran
		ni nastavljivo	nastavljivo za večje mase	samonastavljiv končni položaj z justiranjem za velike mase	izvlečena končna lega	uvlečena končna lega	
	A	P	PPV	YSRW	AJ	EJ	
DFM osnovni tip s krogličnimi vodili							
DFM Enostranska batnica	■	■	-	-	-	-	1 / 6.2-52
DFM osnovni tip z drsnimi vodili							
DFM Enostranska batnica	■	■	-	-	-	-	1 / 6.2-52
DFM-B s krogličnimi vodili							
DFM-B Enostranska batnica	■	■	■ od Ø 16	■ od Ø 20	■	■ od Ø 20	1 / 6.2-74
DFM-B z drsnimi vodili							
DFM-B Enostranska batnica	■	■	■	-	■	■	1 / 6.2-74

Pogoni z linearnimi vodili
Palična vodila

6.2

Vodilne enote DFM

Pregled periferije

FESTO

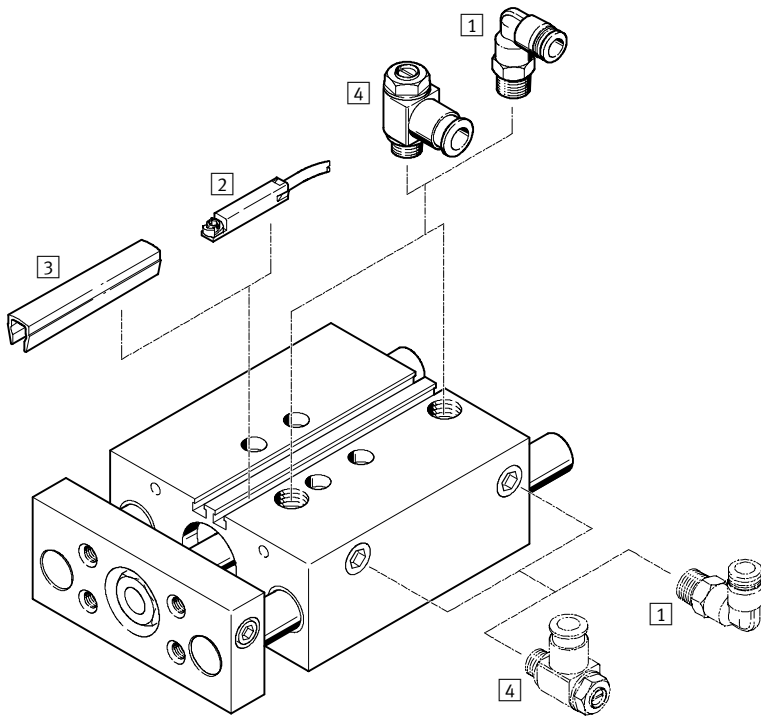

Pribor	Kratek opis	→ Stran
1 Vtično navojni priključek QS	za priključitev cevi za stisnjen zrak s toleranco zunanje mere	Zvezek 3
2 Mejna stikala SME-/SMT-8	z možnostjo integracije v profilno cev	1 / 6.2-104
3 Pokrov utora ABP-5-S	za zaščito kabla senzorja in utorov za senzorje pred onesnaženjem	1 / 6.2-105
4 Povratno dušilni ventil GRLA	za regulacijo hitrosti	1 / 6.2-105
- Centrirne puše ZBH	V obsegu dobave vsebovani 4 kosi	1 / 6.2-104

Vodilne enote DFM

Ključ tipov

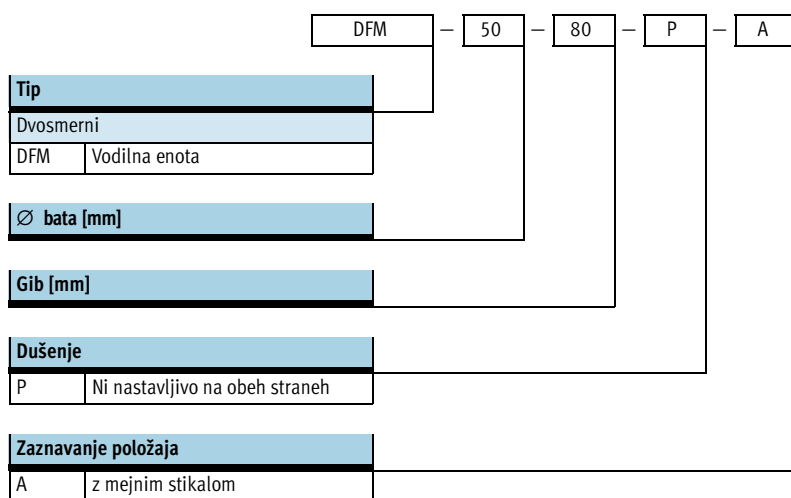

Visoka funkcionalnost

Smer gibanja

Visoka varnost pred zasukom, prevzemanje visokih momentov in prečnih sil

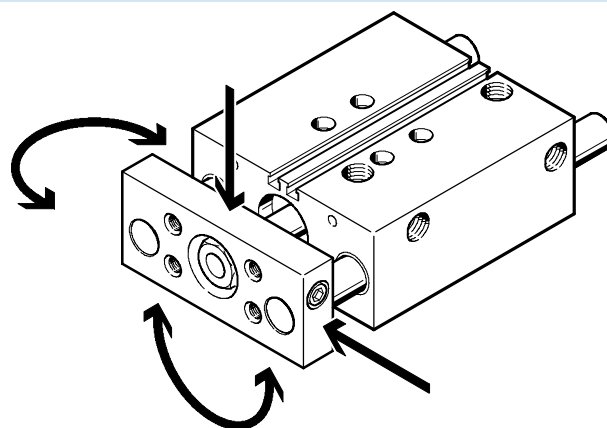
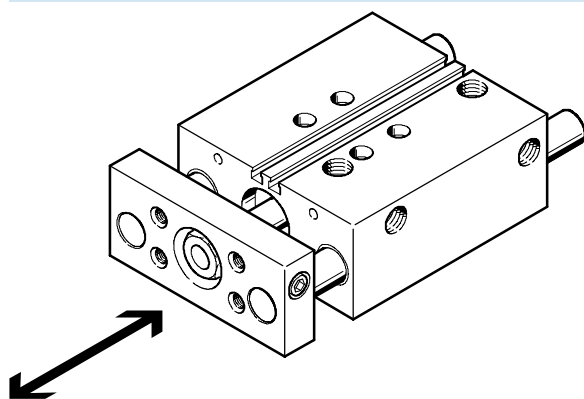

Vodilne enote DFM

Podatkovni list

FESTO

Funkcija

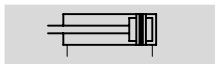

www.festo.com/de/
Servis z nadomestnimi deli



Servisiranje
Drсна vodila GF: \varnothing bata 20 ... 100 mm
Kroglična vodila KF: \varnothing bata 16 ... 100 mm

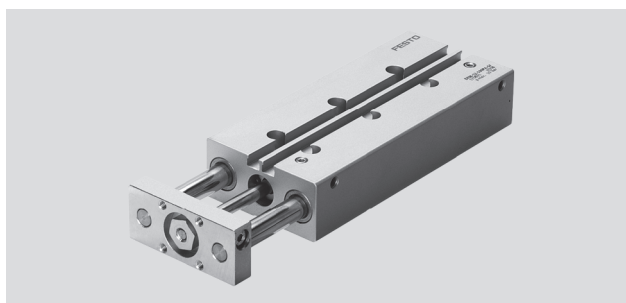

- \varnothing - Premer
12 ... 100 mm
- | - Dolžina giba
10 ... 200 mm

Splošni tehnični podatki										
\varnothing bata	12	16	20	25	32	40	50	63	80	100
Pnevmatični priključek	M5	M5	M5	G $\frac{1}{8}$	G $\frac{1}{8}$	G $\frac{1}{8}$	G $\frac{1}{4}$	G $\frac{1}{4}$	G $\frac{3}{8}$	G $\frac{3}{8}$
Obratovalni medij	Filtriran stisnjen zrak, naoljen ali nenaoljen									
Obratovalni tlak [bar]	2 ... 10			1,5 ... 10			1 ... 10		0,5 ... 10	
Konstrukcija	Bat									
	Batnica									
	Vodilni drogovi z jarmom									
Dušenje	na obeh straneh ni nastavljivo									
Zaznavanje položaja	z mejnim stikalom									
Način pritrditve	s skoznjo izvrtino									
	z notranjim navojem									
Vgradna lega	poljubna									
Varovanje pred zasukom/vodilo	Vodilni drog z jarmom/dršno ali kroglično voden									

Pogoji okolja		
Variante	Drсна vodila GF	Kroglična vodila KF
Temperatura okolice ¹⁾ [°C]	-20 ... +80	-5 ... +60
Obstojnost proti koroziji KBK ²⁾	2	1

1) Upoštevati uporabno območje približevalnega stikala.

2) Razred odpornosti proti koroziji 1 po Festo standardu 940 070

Deli z majhno korozijsko obremenitvijo. Transportna in skladiščna zaščita. Deli brez prednostnih dekorativnih zahtev za površine npr. v nevidni notranjosti ali za pokrovi.

Razred odpornosti proti koroziji 2 po Festo standardu 940 070

deli z zmerno korozijsko obremenitvijo. Vidni deli na zunanji strani s prednostno dekorativno nalogo površine, ki so v neposrednem stiku z običajno industrijsko atmosfero oz. mediji, kot so npr. mazalno-hladilna sredstva.

Hitrosti [m/s]										
\varnothing bata	12	16	20	25	32	40	50	63	80	100
Dušenje P										
Maksimalna hitrost izvlečenje	0,8	0,8	0,8	0,8	0,8	0,8	0,6	0,6	0,4	0,4
Maksimalna hitrost uvlečenje	0,8	0,8	0,8	0,8	0,8	0,8	0,6	0,6	0,4	0,4

Sile [N]										
\varnothing bata	12	16	20	25	32	40	50	63	80	100
Teoretična sila pri 6 bar, gib naprej	68	121	188	295	482	754	1 178	1 870	3 016	4 712
Teoretična sila pri 6 bar, gib nazaj	51	90	141	247	415	686	1 057	1 750	2 827	4 418

Vodilne enote DFM

Podatkovni list

FESTO

Udarna energija [J]										
∅ bata	12	16	20	25	32	40	50	63	80	100
Maks. udarna energija v končnih legah	0,09	0,10	0,14	0,35	0,40	0,52	0,64	0,70	0,75	1,00

Dopustna naletna hitrost:

$$v_{zul.} = \sqrt{\frac{2 \times E_{zul.}}{m_{Eigen} + m_{Last}}}$$

Maksimalna dopustna masa:

$$m_{Last} = \frac{2 \times E_{zul.}}{v^2} - m_{Eigen}$$

 - Opozorilo

Ti podatki predstavljajo maksimalne dosegljive vrednosti. V praksi lahko te vrednosti nihajo glede na maso koristnega bremena. Nadalje je

potrebno upoštevati mejne vrednosti zmožnosti dušenja pogonskega valja ter dopustno udarno energijo.

DFM z drsnimi vodili GF										
Gib [mm]	∅ bata [mm]									
	12	16	20	25	32	40	50	63	80	100
Masa izdelka [g]										
10	340	450	-	-	-	-	-	-	-	-
20	375	515	780	1 250	1 770	-	-	-	-	-
25	405	540	825	1 270	1 835	2 145	3 410	4 420	-	-
30	435	575	865	1 340	1 915	-	-	-	-	-
40	495	710	1 060	1 420	2 120	-	-	-	-	-
50	540	770	1 150	1 630	2 230	2 520	4 060	5 140	-	-
80	690	920	1 350	1 990	2 795	2 980	4 960	5 720	-	-
100	775	1 090	1 595	2 230	3 095	3 535	5 500	7 990	-	-
125	-	-	-	-	3 915	6 300	8 760	8 760	-	-
160	-	-	-	-	4 520	7 230	9 040	9 040	-	-
200	-	-	-	-	5 390	8 250	10 140	10 150	-	-
Gibajoče se mase [g]										
10	170	230	-	-	-	-	-	-	-	-
20	190	250	400	650	1 040	-	-	-	-	-
25	190	260	420	670	1 070	1 190	2 050	2 510	4 140	6 300
30	200	280	440	690	1 090	-	-	-	-	-
40	230	340	550	760	1 150	-	-	-	-	-
50	250	370	580	800	1 210	1 330	2 280	2 740	4 720	7 110
80	290	430	680	910	1 480	1 600	2 720	3 190	5 460	8 140
100	320	470	740	990	1 590	1 720	2 910	3 370	5 730	8 520
125	-	-	-	-	1 840	1 960	3 300	3 760	6 080	9 000
160	-	-	-	-	2 040	2 170	3 630	4 090	6 550	9 670
200	-	-	-	-	2 280	2 400	4 000	4 460	7 100	10 430

Vodilne enote DFM

Podatkovni list

FESTO

Pogoni z linearnimi vodili
Palična vodila

6.2

DFM s krogličnimi vodili KF										
Gib [mm]	Ø bata [mm]									
	12	16	20	25	32	40	50	63	80	100
Masa izdelka [g]										
10	320	425	-	-	-	-	-	-	-	-
20	340	485	735	1 185	1 585	-	-	-	-	-
25	380	510	760	1 215	1 640	1 955	3 085	4 130	-	-
30	405	535	810	1 290	1 715	-	-	-	-	-
40	470	650	970	1 425	1 850	-	-	-	-	-
50	510	705	1 050	1 535	1 995	2 345	3 655	4 835	-	-
80	560	880	1 290	1 875	2 425	2 870	4 440	5 340	-	-
100	725	990	1 330	2 090	2 730	3 170	4 880	6 140	-	-
125	-	-	-	-	3 620	5 580	7 380	-	-	-
160	-	-	-	-	4 165	6 365	8 130	-	-	-
200	-	-	-	-	4 800	7 340	9 240	-	-	-
Gibajoče se mase [g]										
10	150	200	-	-	-	-	-	-	-	-
20	160	220	360	590	860	-	-	-	-	-
25	160	230	380	600	880	1 000	1 720	2 180	3 670	5 700
30	170	240	390	620	900	-	-	-	-	-
40	190	290	480	670	960	-	-	-	-	-
50	200	300	500	700	980	1 100	1 880	2 340	4 090	6 320
80	230	350	570	790	1 160	1 280	2 180	2 640	4 630	7 110
100	250	380	620	850	1 240	1 360	2 310	2 770	4 840	7 410
125	-	-	-	-	1 400	1 530	2 580	3 040	5 090	7 780
160	-	-	-	-	1 540	1 670	2 810	3 270	5 450	8 310
200	-	-	-	-	1 710	1 830	3 070	3 530	5 860	8 910

Materiali

Funkcijski prerez

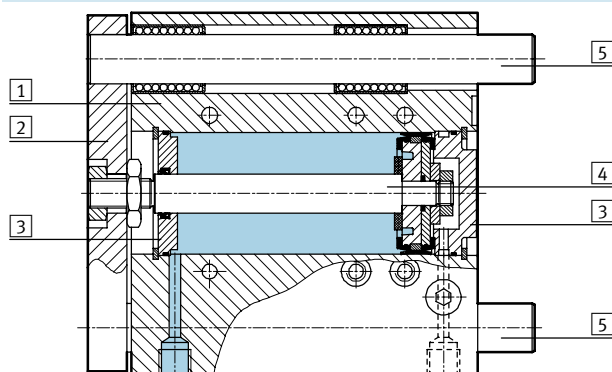

Variante	Drsna vodila GF	Kroglična vodila KF
1 Ohišje	Al zlitina za kovanje, eloksirana	Al zlitina za kovanje, eloksirana
2 Plošča jarma	jeklo za poboljšanje	jeklo za poboljšanje
3 Ležajni in zaključni pokrov	Al zlitina za kovanje, eloksirana	Al zlitina za kovanje, eloksirana
4 Batnica	visokolegirano nerjavno jeklo	visokolegirano nerjavno jeklo
5 Vodilni drogovi	visokolegirano nerjavno jeklo	jeklo za poboljšanje
- Statična tesnila	nitrilkavčuk	nitrilkavčuk
- Dinamična tesnila	poliuretan	poliuretan
- Mazalno sredstvo	Klüberplex BE 31-102	Klüberplex BE 31-102
Opomba za material	-	Brez bakra, PTFE in silikonov

Vodilne enote DFM

Podatkovni list

FESTO

Maksimalna koristna obremenitev F [N]

Drсна vodila GF in kroglična vodila KF

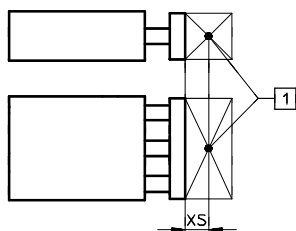

1 Masno središče koristnega bremena

Ø bata [mm]	XS [mm]	Gib [mm]											
		10	20	25	30	40	50	80	100	125	160	200	
12	GF	25	28	24	23	21	31	28	22	19	-	-	-
	KF		27	23	21	20	23	22	20	19	-	-	-
16	GF	50	63	56	53	51	73	67	55	49	-	-	-
	KF		45	31	27	24	58	56	51	48	-	-	-
20	GF	50	-	67	64	61	110	103	86	77	-	-	-
	KF		-	45	39	35	91	88	80	75	-	-	-
25	GF	50	-	121	116	112	123	115	96	86	-	-	-
	KF		-	88	86	84	100	97	89	85	-	-	-
32	GF	50	-	188	180	173	161	150	166	150	168	146	127
	KF		-	120	118	116	112	109	134	128	144	135	126
40	GF	50	-	-	180	-	-	150	166	150	168	146	127
	KF		-	-	118	-	-	109	134	128	144	135	126
50	GF	50	-	-	257	-	-	216	234	212	229	200	174
	KF		-	-	182	-	-	168	201	193	211	199	188
63	GF	50	-	-	257	-	-	216	234	212	229	200	174
	KF		-	-	182	-	-	168	201	193	211	199	188
80	GF	125	-	-	276	-	-	311	352	329	304	274	245
	KF		-	-	220	-	-	275	329	318	306	291	277
100	GF	125	-	-	452	-	-	509	568	533	494	446	400
	KF		-	-	332	-	-	415	495	480	463	442	422

Dopustna momentna obremenitev M [Nm]

Drсна vodila GF in kroglična vodila KF



Ø bata [mm]		XS [mm]	Gib [mm]										
			10	20	25	30	40	50	80	100	125	160	200
12	GF	25	0,60	0,50	0,48	0,45	0,65	0,60	0,45	0,40	-	-	-
	KF		0,55	0,47	0,44	0,42	0,47	0,45	0,41	0,38	-	-	-
16	GF	50	1,44	1,30	1,23	1,18	1,68	1,56	1,28	1,14	-	-	-
	KF		1,03	0,71	0,62	0,55	1,34	1,29	1,18	1,12	-	-	-
20	GF	50	-	1,85	1,75	1,70	3,00	2,80	2,35	2,10	-	-	-
	KF		-	1,30	1,13	1,01	2,64	2,56	2,34	2,23	-	-	-
25	GF	50	-	4,15	3,95	3,80	4,20	3,90	3,25	2,90	-	-	-
	KF		-	3,00	2,92	2,85	3,40	3,30	3,02	2,89	-	-	-
32	GF	50	-	7,30	7,00	6,70	6,20	5,80	6,40	5,80	6,50	5,70	5,00
	KF		-	4,70	4,60	4,55	4,40	4,25	5,25	5,00	5,60	5,25	4,90
40	GF	50	-	-	7,90	-	-	6,55	7,25	6,55	7,35	6,40	5,55
	KF		-	-	5,20	-	-	4,80	5,90	5,65	6,35	5,95	5,55
50	GF	50	-	-	14,15	-	-	11,85	12,85	11,65	12,55	11,00	9,60
	KF		-	-	10,00	-	-	9,30	11,00	10,60	11,60	11,00	10,30
63	GF	50	-	-	15,90	-	-	13,30	14,45	13,10	14,10	12,30	10,70
	KF		-	-	11,30	-	-	10,50	12,50	12,00	13,20	12,40	11,70
80	GF	125	-	-	21,40	-	-	24,20	27,20	25,50	23,50	21,30	19,00
	KF		-	-	17,10	-	-	21,30	25,50	24,70	23,70	22,60	21,50
100	GF	125	-	-	42,40	-	-	47,80	53,40	50,10	46,40	42,00	37,60
	KF		-	-	25,70	-	-	32,20	38,40	37,20	35,90	34,20	32,70

Vodilne enote DFM

Podatkovni list

FESTO

Vzvojna zračnost ρ

Drsna vodila GF in kroglična vodila KF v uvlečenem stanju, neobremenjena

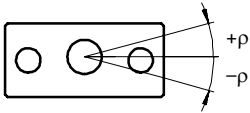

\varnothing bata		12	16	20	25	32	40	50	63	80	100
Vzvojna zračnost [°]	GF	0,09	0,09	0,07	0,07	0,06	0,06	0,05	0,05	0,03	0,03
	KF	0,08	0,08	0,07	0,07	0,05	0,05	0,05	0,05	0,03	0,03

Odklon batnice

Zračnost ležaja drsnih vodil GF in krogličnih vodil KF (brez bremena)

DFM-12 ... 20 gibov \leq 30 mm

DFM-12 ... 20 gibov $>$ 30 mm

DFM-25 ... 100:

En ležaj na vodilni drog

Dva ležaja na vodilni drog

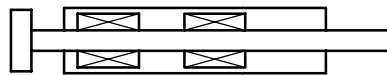
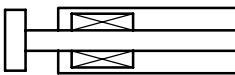

\varnothing bata		12	16	20	25	32	40	50	63	80	100
Zračnost ležaja [mm]	GF	0,11	0,11	0,11	0,10	0,13	0,13	0,12	0,12	0,12	0,12
	KF	0,10	0,08	0,08	0,08	0,08	0,08	0,08	0,08	0,07	0,07

Srednji odmik f_1 zaradi zračnosti ležaja v odvisnosti od giba l

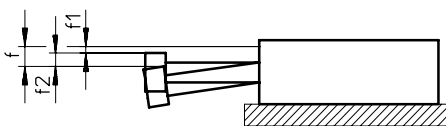

$$f = f_1 + f_2$$

f = skupni odklon batnice

f_1 = odmik zaradi zračnosti ležaja

f_2 = odmik zaradi prečne sile

DFM z dvema ležajema na vodilni drog

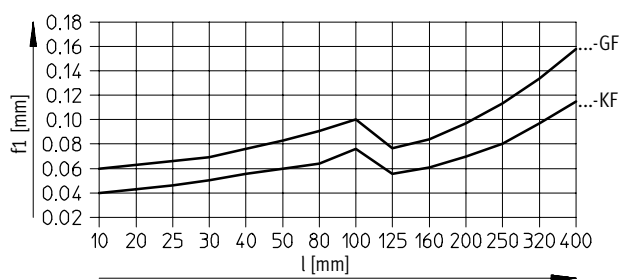

Vodilne enote DFM

Podatkovni list

Uporaba kot zaustavljajni valj

Dopustna udarna energija

Dopustne kinetične energije udarca v končni prislon se ne sme prekoračiti.

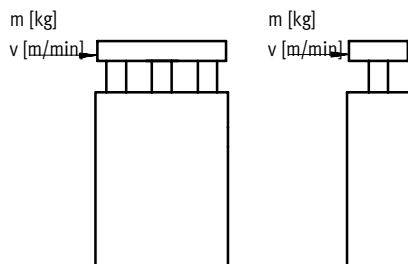

 Opozorilo
Tu se lahko uporabljajo vodilne enote z drsnimi vodili GF ($l_{\text{maks.}} = 50 \text{ mm}$).

Naletna masa m v odvisnosti od naletne hitrosti v

DFM-12 ... 25-GF
Gib < 30 mm

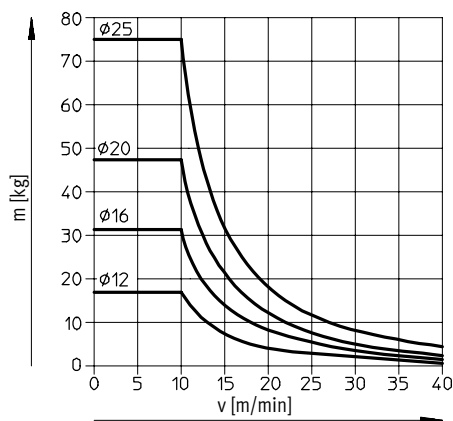

Za vrednosti v zgornjem diagramu je predpostavljen elastičen odbojnik na nosilcu obdelovanca z deformacijo 1 mm. Uporabijo se lahko vodilne enote z drsnimi vodili GF < 30 mm gib.

DFM-32 ... 100-GF
Gib < 50 mm

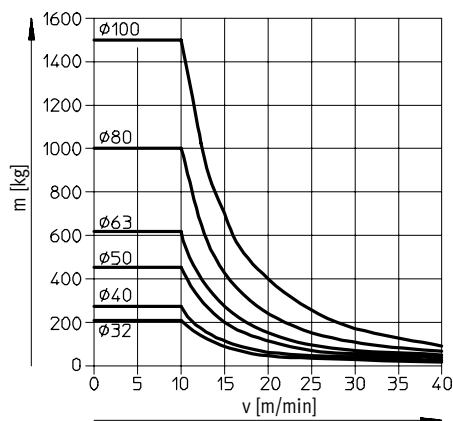

Za vrednosti v zgornjem diagramu je predpostavljen elastičen odbojnik na nosilcu obdelovanca z deformacijo 2 mm. Uporabijo se lahko vodilne enote z drsnimi vodili GF < 50 mm gib.

Vodilne enote DFM

Podatkovni list



Uporaba kot dvizni valj

Dopustna obremenitev kot drsna vodila GF

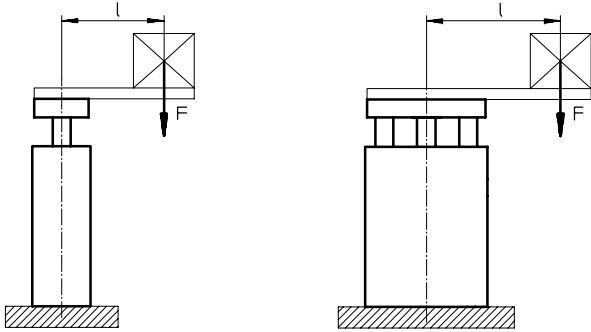

F = vzdolžna sila [N]
L = ročica [mm]

DFM-12 ... 25-GF

Gib 30 mm

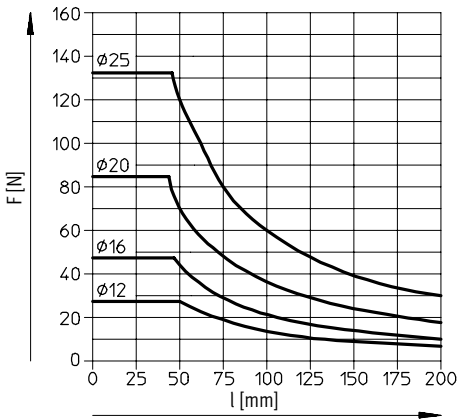

DFM-12 ... 25-GF

Gib 40 ... 100 mm

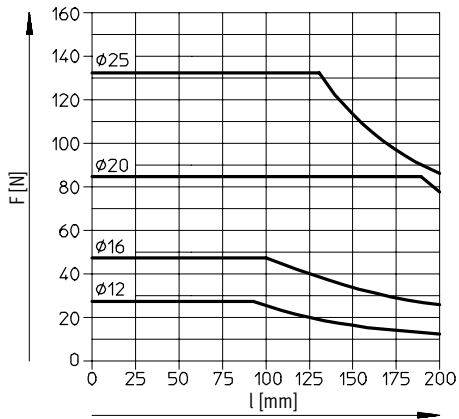

DFM-32 ... 63-GF

Gib 50 mm

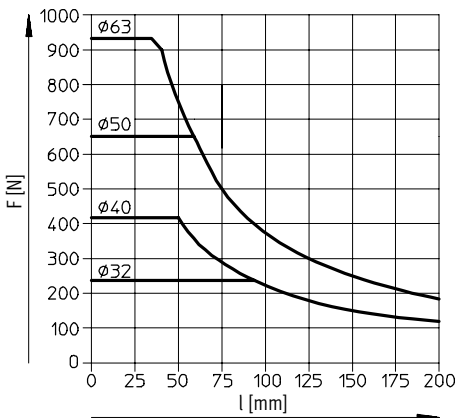

DFM-32 ... 63-GF

Gib 80 ... 100 mm

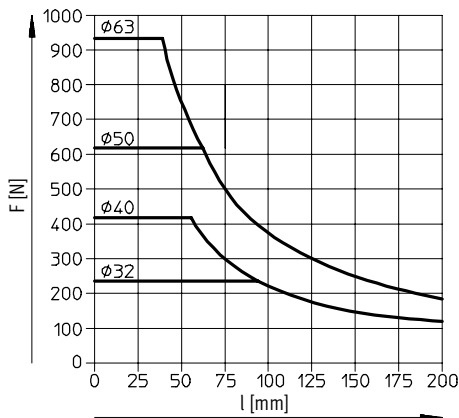

Vodilne enote DFM

Podatkovni list

Uporaba kot dvizni valj

Dopustna obremenitev kot drsna vodila GF

DFM-32 ... 63-GF

Gib 125 ... 200 mm

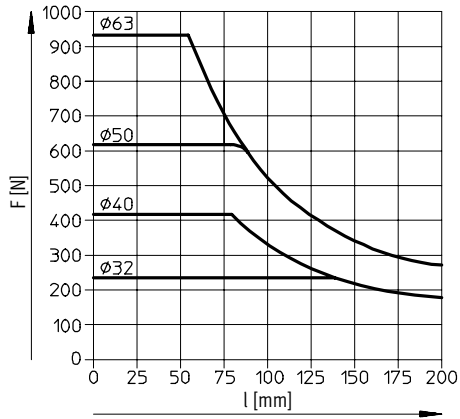

DFM-80 ... 100-GF

Gib 25 mm

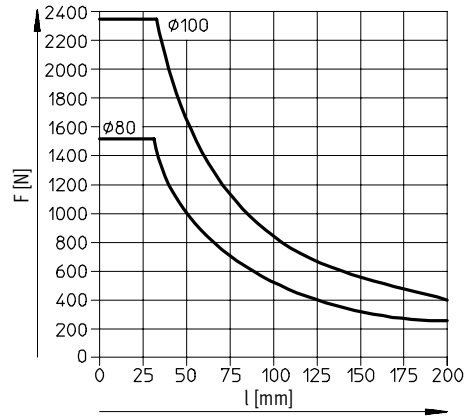

DFM-80 ... 100-GF

Gib 50 mm

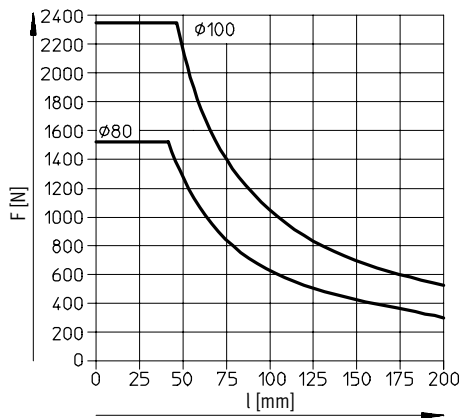

DFM-80 ... 100-GF

Gib 80 ... 200 mm

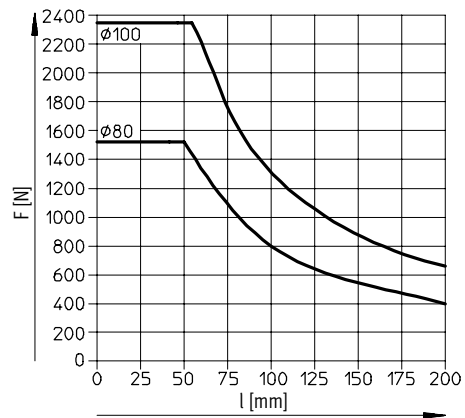

Vodilne enote DFM

Podatkovni list



Uporaba kot dvizni valj

Dopustna obremenitev s krogličnimi vodili KF

DFM-12 ... 25-KF

Gib 30 mm

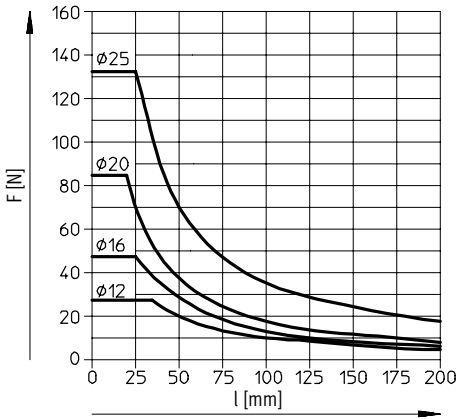

DFM-12 ... 25-KF

Gib 40 ... 100 mm

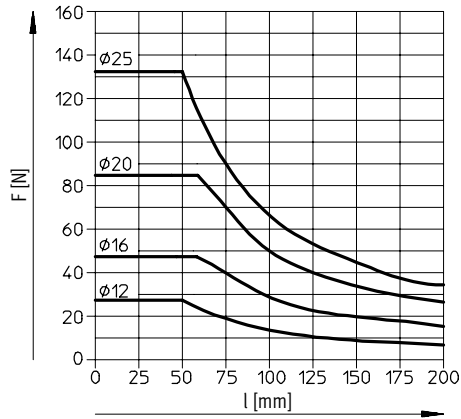

DFM-32 ... 63-KF

Gib 50 mm

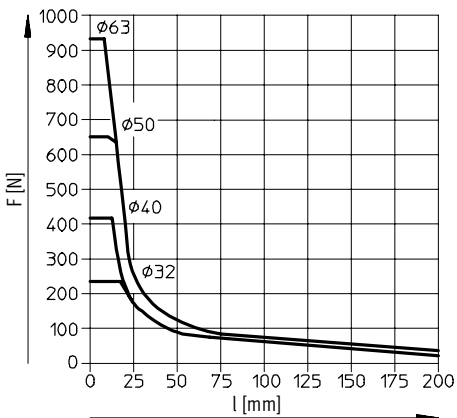

DFM-32 ... 63-KF

Gib 80 ... 100 mm

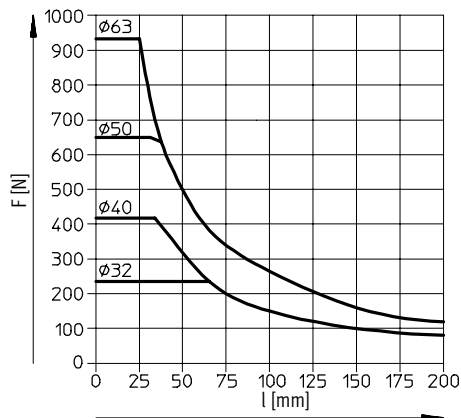

Vodilne enote DFM

Podatkovni list

FESTO

Uporaba kot dvizni valj

Dopustna obremenitev s krogličnimi vodili KF

DFM-32 ... 63-KF

Gib 125 ... 200 mm

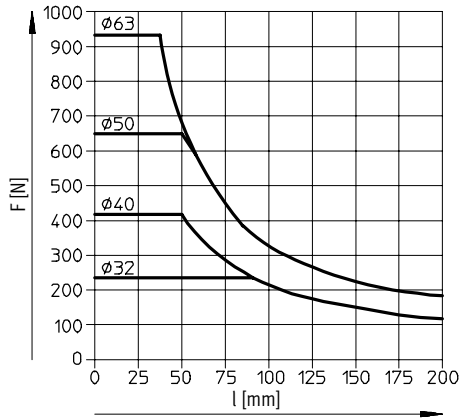

DFM-80 ... 100-KF

Gib 25 mm

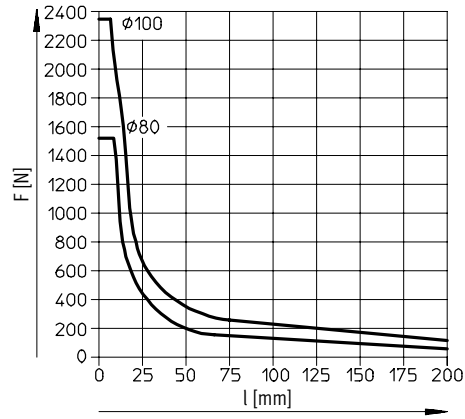

DFM-80 ... 100-KF

Gib 50 mm

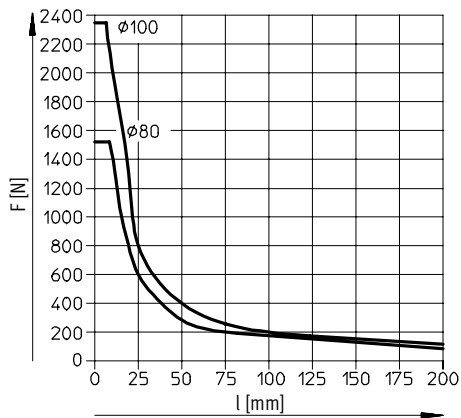

DFM-80 ... 100-KF

Gib 80 ... 200 mm

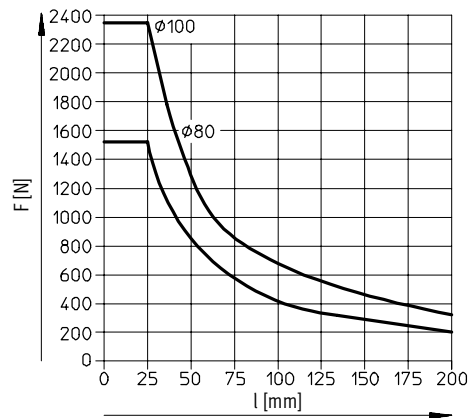

Vodilne enote DFM

Podatkovni list

FESTO

Dimenzije

Ø bata 12 ... 16 mm

Prenos CAD-datotek → www.festo.com/de/engineering

Pogoni iz linearnimi vodilji
Palična vodila

6.2

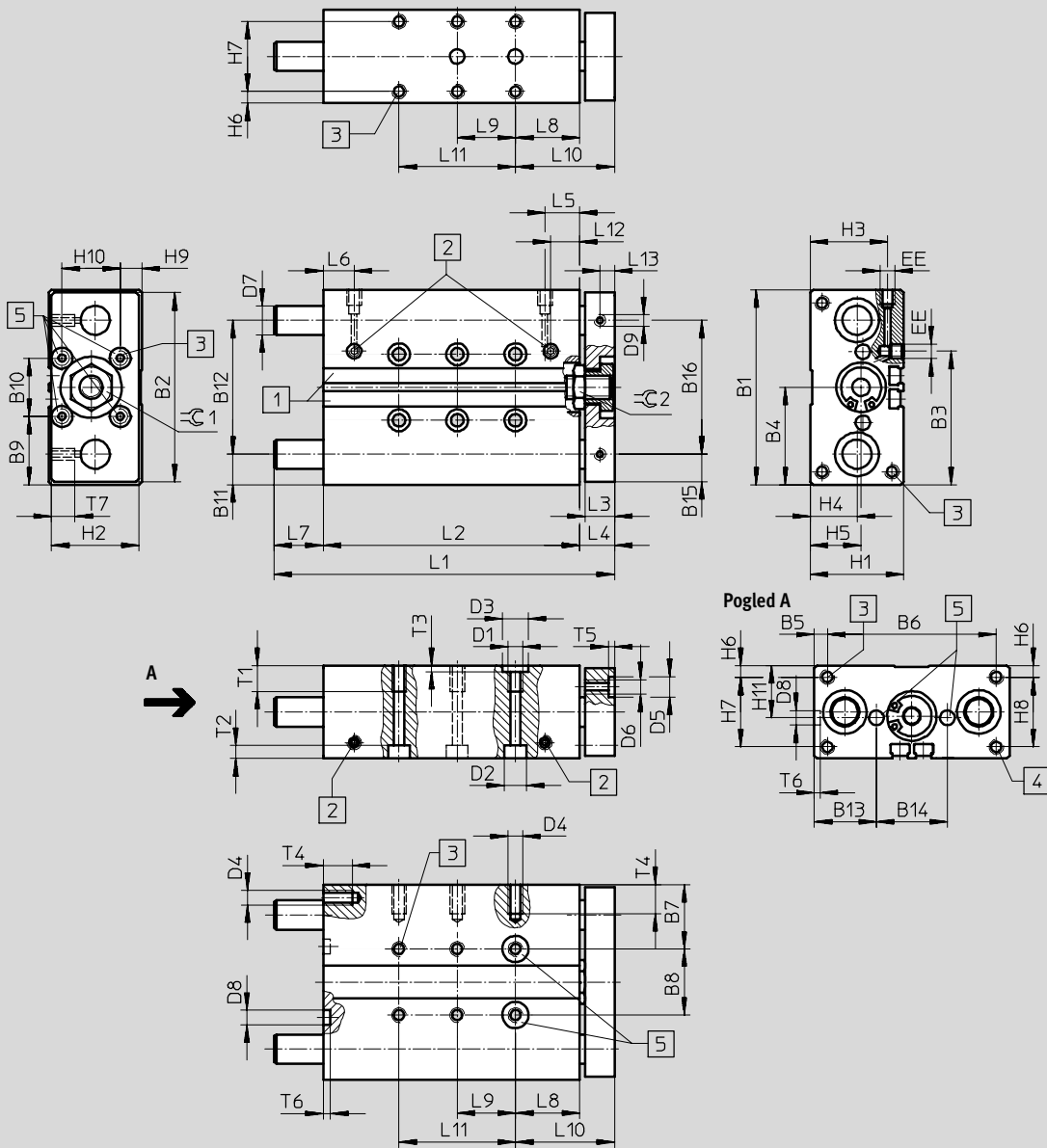

1 Pritrdilni utor za mejna stikala
SME-/SMT-8

2 Priključek za zrak po želji ob
strani ali zgoraj

3 Pritrdilni navoj
4 Pritrdilni navoj (ni pri Ø 12 ...
20)

5 Toleranca med centrirnimi
izvrtinami ± 0,02 mm (Ø 12
in 16 mm na prirobnični plošči
nimajo centrirnih izvrtin)

Vodilne enote DFM

Podatkovni list

FESTO

∅ [mm]	B1	B2	B3	B4	B5	B6	B7	B8	B9	B10	B11	B12	B13	B14	B15	B16	D1	D2 ∅	D3 ∅ H7	D4
12	60	58	42,4	30	4,5	51	20,5	19	20	20	9,5	41	19,5	21	8,5	41	M5	8	9	M4
16	67	65	45,9	33,5	4,5	58	22	23	23,5	20	10,5	46	21,3	24,4	-	-	M5	7,5	9	M5

∅ [mm]	D5 ∅ H7	D6	D7 ∅		D8 ∅ H7	D9	EE	H1	H2	H3	H4	H5	H6	H7	H8	H9	H10	H11
			GF	KF														
12	-	M4	10h8	8h6	5	M4	M5	28	26	24	14	14	4	20	-	4	20	14
16	-	M5	12h8	10h6	5	-	M5	32	30	26,5	16	17,4	4	24	-	7,4	20	16

∅ [mm]	Gib [mm]	L1	L2	L3	L4	L5	L6	L7	L8	L9	L10 ±0,1	L11
12	10	59	46	10	13	11,4	9,5	-	21	-	34	-
	20	69	56					-		-		
	25	74	61					-		20		-
	30	79	66					-		20		-
	40	89	76					6		20		-
	50	105	86					6		40		-
	80	135	116					6		40		-
	100	155	136					6		40		80
16	10	60	48	10	12	11,9	10,6	-	22	-	34	-
	20	70	58					-		-		
	25	75	63					-		20		-
	30	80	68					-		20		-
	40	107	78					17		20		-
	50	117	88					17		40		-
	80	147	118					17		40		-
	100	167	138					17		40		80

∅ [mm]	Gib [mm]	L12	L13	T1	T2	T3	T4	T5	T6	T7	≈C 1	≈C 2
12	10	11,4	5	9	9,4	2,1	8	-	1	8	10	10
	20											
	25											
	30											
	40											
	50											
	80											
100												
16	10	11,9	-	9	4,6	2,1	10	-	1	-	14	14
	20											
	25											
	30											
	40											
	50											
	80											
100												

Pogoni z linearnimi vodilji
Palična vodila

6.2

Vodilne enote DFM

Podatkovni list



Dimenzije

Ø bata 20 ... 25 mm

Prenos CAD-datotek → www.festo.com/de/engineering

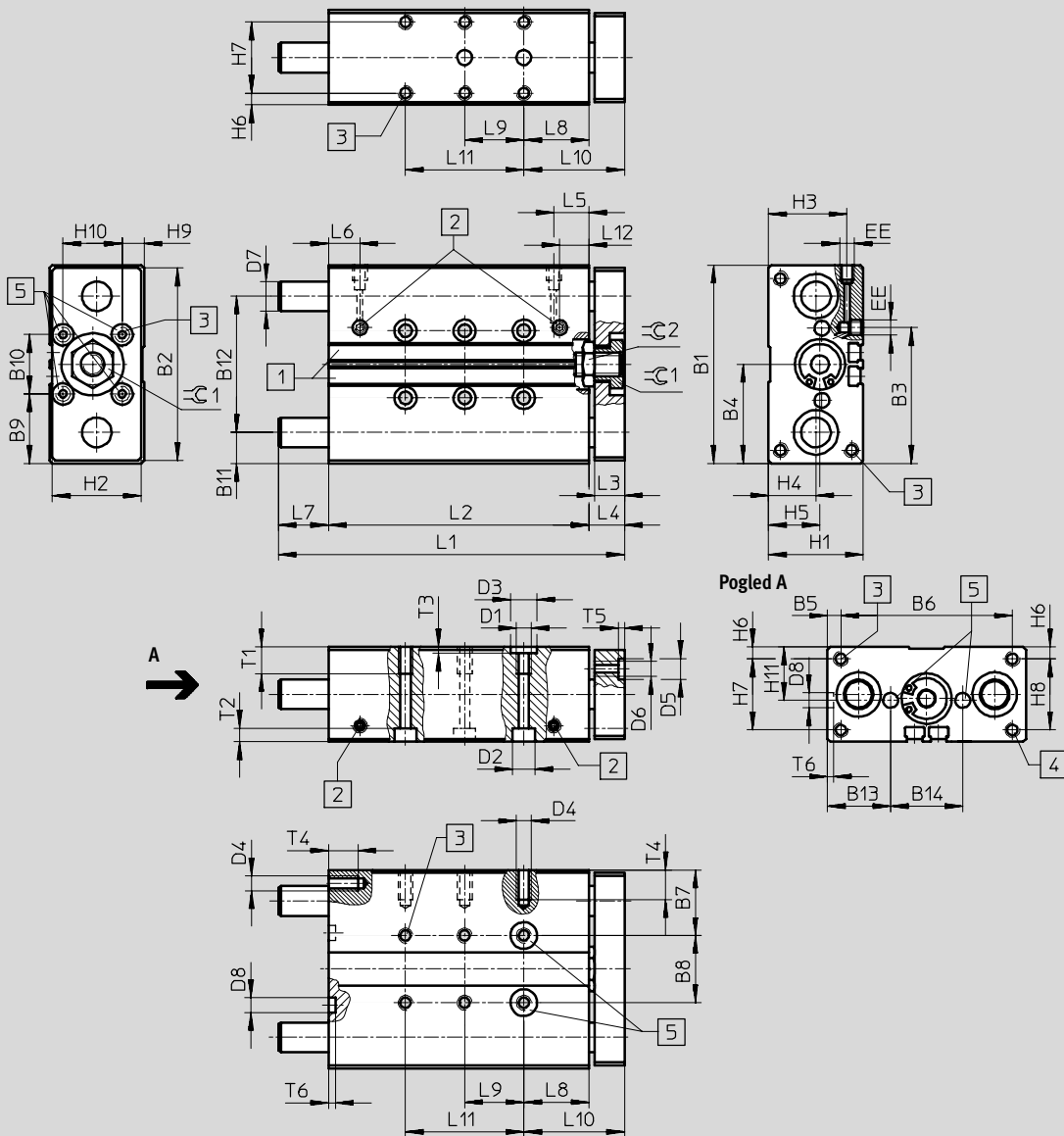

1 Pritrdilni utor za mejna stikala SME-/SMT-8

2 Priključek za zrak po želji ob strani ali zgoraj

3 Pritrdilni navoj
4 Pritrdilni navoj (ni pri Ø 12 ... 20)

5 Toleranca med centrirnimi izvrtinami ± 0,02 mm

- - Opozorilo

Pri vodilnih enotah DFM-25 ... 100 z dolžinami giba od 40 mm segajo vodilni drogovi v zadnji končni legi izven konture ohišja. Pri tem je

potrebno paziti, da se sestavni del pri montaži s čelne strani na zapirni pokrov ne prekrije, da ne onemogoča prostega gibanja vodilnih drogov.

Vodilne enote DFM

Podatkovni list

FESTO

∅ [mm]	B1	B2	B3	B4	B5	B6	B7	B8	B9	B10	B11	B12	B13	B14	D1	D2 ∅	D3 ∅ H7	D4
20	83	81	53,6	41,5	6,5	70	26,5	30	26,5	30	12,5	58	26	31	M6	9	9	M5
25	95	93	70	47,5	15,5	64	30	35	27,5	40	13,5	68	29	37	M6	9	9	M6

∅ [mm]	D5 ∅ H7	D6	D7 ∅		D8 ∅ H7	EE	H1	H2	H3	H4	H5	H6	H7	H8	H9	H10	H11
			GF	KF													
20	9	M5	14h8	12h6	7	M5	36	34	29,5	17	17	4,5	27	-	7	20	18
25	9	M6	16h8	14h6	7	G1/8	44	42	34,8	19	23,9	4,5	35	35	12	20	22

∅ [mm]	Gib [mm]	L1	L2	L3	L4	L5	L6	L7	L8	L9	L10 ±0,1	L11
20	20	75	61	12	14	14	10,5	-	26	-	40	-
	25	80	66					-		20		-
	30	85	71					-		20		-
	40	121	81					26		20		-
	50	131	91					26		40		-
	80	161	121					26		40		-
	100	181	141					26		40		80
25	20	93	65,6	12	14	17,5	9,5	13,4	26	-	40	-
	25	98	70,6					13,4		20		-
	30	103	75,6					13,4		20		-
	40	123	85,6					23,4		20		-
	50	133	95,6					23,4		40		-
	80	163	125,6					23,4		40		-
	100	183	145,6					23,4		40		80

∅ [mm]	Gib [mm]	L12	T1	T2	T3	T4	T5	T6	≈ 1	≈ 2
20	20	14	12	5,7	2,1	10	2,1	1,6	17	17
	25									
	30									
	40									
	50									
	80									
25	20	15	14	5,7	2,1	12	2,1	1,6	17	17
	25									
	30									
	40									
	50									
	80									

Pogoni z linearnimi vodilji
Palična vodila

6.2

Vodilne enote DFM

Podatkovni list

FESTO

Dimenzije

Ø bata 32 ... 63 mm

Prenos CAD-datotek → www.festo.com/de/engineering

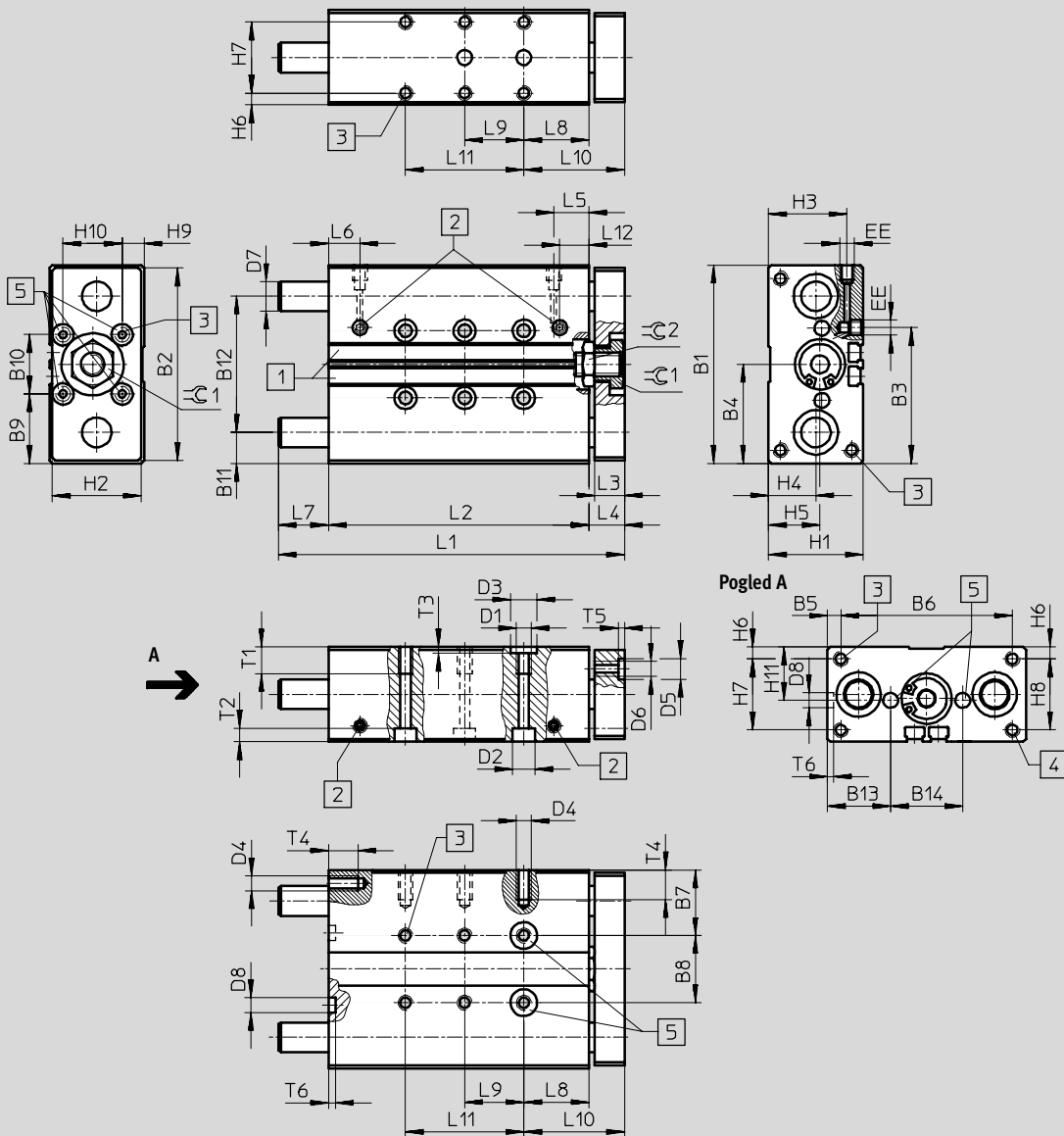

1 Pritrdilni utor za mejna stikala SME-/SMT-8

2 Priključek za zrak po želji ob strani ali zgoraj

3 Pritrdilni navoj

4 Ta pritrdilni navoj pri Ø 12 ... 20 ni na voljo

5 Toleranca med centrirnimi izvrtinami ±0,02 mm

-  Opozorilo

Pri vodilnih enotah DFM-25 ... 100 z dolžinami giba od 40 mm segajo vodilni drogovi v zadnji končni legi izven konture ohišja. Pri tem je

potrebno paziti, da se sestavni del pri montaži s čelne strani na zapirni pokrov ne prekrije, da ne onemogoča prostega gibanja vodilnih drogov.

Vodilne enote DFM

Podatkovni list



∅	B1	B2	B3	B4	B5	B6	B7	B8	B9	B10	B11	B12	B13	B14	D1	D2 ∅	D3 ∅ H7	D4
[mm]																		
32	110	108	81	55	20	70	33,5	43	35	40	16	78	32,5	45	M8	11	12	M6
40	120	118	94	60	15	90	34,5	51	35	50	16	88	32,5	55	M8	11	12	M8
50	148	146	116,5	74	19	110	42	64	44	60	19	110	40	68	M8	11	12	M8
63	162	160	139	81	9	144	41	80	41	80	18,4	125	39,5	83	M10	15	12	M10

∅	D5	D6	D7		D8	EE	H1	H2	H3	H4	H5	H6	H7	H8	H9	H10	H11
	∅		∅		∅												
[mm]	H7		GF	KF	H7												
32	9	M6	20h8	16h6	9	G $\frac{1}{8}$	49	47	38,5	22	23,5	6	37	37	8,5	30	24,5
40	9	M6	20h8	16h6	9	G $\frac{1}{8}$	54	52	40,5	24	25	6	42	42	10	30	27
50	12	M8	25h8	20h6	12	G $\frac{1}{4}$	64	62	50,5	29,5	29,7	7	50	50	12	40	32
63	12	M8	25h8	20h6	12	G $\frac{1}{4}$	78	76	55	32	36,8	9	60	60	19	40	39

∅	Gib	L1	L2	L3	L4	L5	L6	L7	L8	L9	L10	L11	L12	T1	T2	T3	T4	T5	T6	≈ 1	≈ 2
	[mm]	[mm]									±0,1										
32	20	101	68	14	16	17	12	17	29	-	45	-	17	15	6,8	2,6	12	2,1	2,1	17	22
	25	106	73					17		20		-									
	30	111	78					17		20		-									
	40	121	88					17		20		-									
	50	131	98					17		40		-									
	80	179	128					35		40		-									
	100	199	148					35		40		80									
	125	244	173					55		40		80									
	160	279	208					55		40		120									
	200	319	248					55		40		160									
40	25	106	76	14	16	17,8	13,1	14	29	20	45	-	17,8	15	6,8	2,6	16	2,1	2,1	17	22
	50	131	101					14		40		-									
	80	179	131					32		40		-									
	100	199	151					32		40		80									
	125	244	176					52		40		80									
	160	279	211					52		40		120									
200	319	251	52	40	160																
50	25	118	77	16	18	17,8	14,2	23	32	20	50	-	17,8	15	6,8	2,6	16	2,6	2,6	19	24
	50	143	102					23		40		-									
	80	194	132					44		40		-									
	100	214	152					44		40		80									
	125	259	177					64		40		80									
	160	294	212					64		40		120									
	200	334	252					64		40		160									
63	25	118	83	16	18	18,5	14,8	17	32	20	50	-	18,5	20	9	2,6	20	2,6	2,6	19	24
	50	143	108					17		40		-									
	80	194	138					38		40		80									
	100	214	158					38		40		80									
	125	259	183					58		40		120									
	160	294	218					58		40		160									
	200	334	258					58		40		200									

Pogoni z linearnimi vodilji
Palična vodila

6.2

Vodilne enote DFM

Podatkovni list

FESTO

Dimenzije

Ø bata 80 ... 100 mm

Prenos CAD-datotek → www.festo.com/de/engineering

Pogoni z linearnimi vodilji
Palična vodila

6.2

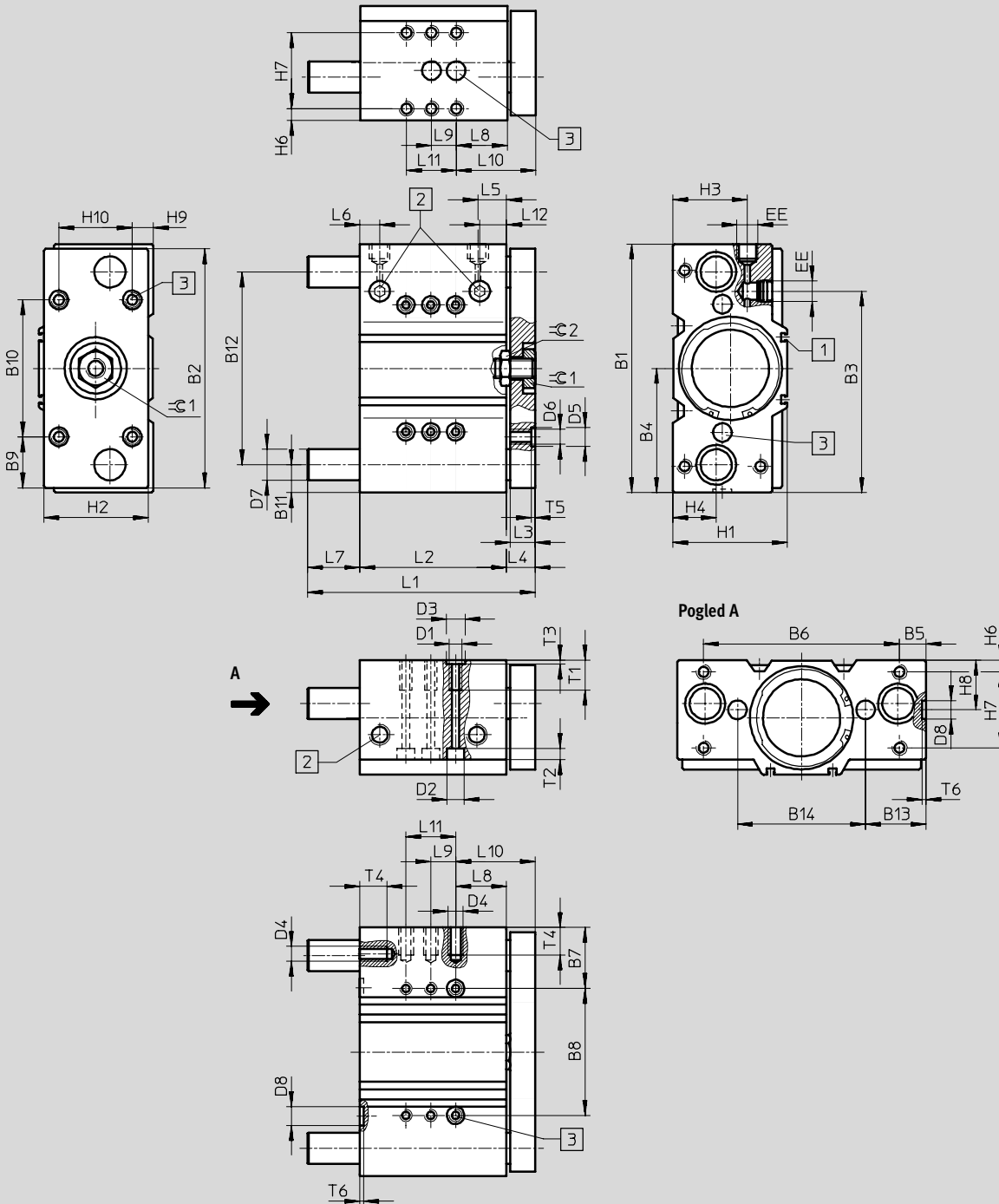

1 Pritrdilni utor za mejna stikala SME-/SMT-8

2 Priključek za zrak po želji ob strani ali zgoraj

3 Toleranca med centrirnimi izvrtinami $\pm 0,02$ mm

- - Opozorilo

Pri vodilnih enotah DFM-25 ... 100 z dolžinami giba od 40 mm segajo

vodilni drogovi v zadnji končni legi izven konture ohišja. Pri tem je

potrebno paziti, da se sestavni del pri montaži s čelne strani na zapirni

pokrov ne prekrije, da ne onemogoča prostega gibanja vodilnih drogov.

Vodilne enote DFM

Podatkovni list



∅ [mm]	B1	B2	B3	B4	B5	B6	B7	B8	B9	B10	B11	B12	B13	B14	D1	D2 ∅	D3 ∅ H7
80	200	192	162,5	100	21,5	157	48,5	103	41	110	22,5	155	48,5	103	M10	15	12
100	240	232	201	120	21	198	54	132	56	120	26	188	57	126	M12	18	15

∅ [mm]	D4	D5 ∅ H7	D6	D7 ∅		D8 ∅ H7	EE	H1	H2	H3	H4	H6	H7	H8	H9	H10
				GF	KF											
80	M10	12	M10	30h8	25h6	12	G $\frac{3}{8}$	92	84	61	35	9	62	40	16	60
100	M12	15	M12	35h8	30h6	15	G $\frac{3}{8}$	112	104	66	39,5	10	68	44	16	80

∅ [mm]	Gib [mm]	L1	L2	L3	L4	L5	L6	L7	L8	L9	L10 ±0,1	L11	L12	T1	T2	T3	T4	T5	T6	≈C 1	≈C 2
50	183	118	42	-																	
80	243	148	72	-																	
100	263	168	72	80																	
125	288	193	72	80																	
160	323	228	72	120																	
200	363	268	72	160																	
100	25	150	109	20	23	29	20	18	13	40	36	-	29	25	11	3,1	24	3,1	3,1	32	30
50	197	134	40					80													
80	257	164	70					80													
100	277	184	70					120													
125	302	209	70					160													
160	337	244	70					160													
200	377	284	70					200													

Pogoni z linearnimi vodilji
Palična vodila

6.2

Vodilne enote DFM

Podatkovni list

FESTO

Pogoni z linearnimi vodili
Palična vodila

6.2

Podatki za naročanje – drsna vodila GF														
		Št. dela		Tip		Št. dela		Tip		Št. dela		Tip		
Gib [mm]		Ø bata 12 mm		Ø bata 16 mm		Ø bata 20 mm								
10	170 824	DFM-12-10-P-A-GF	170 832	DFM-16-10-P-A-GF	–	–	–	–	–	–	–	–	–	
20	170 825	DFM-12-20-P-A-GF	170 833	DFM-16-20-P-A-GF	170 840	DFM-20-20-P-A-GF	170 841	DFM-20-25-P-A-GF	170 842	DFM-20-30-P-A-GF	170 843	DFM-20-40-P-A-GF	170 844	DFM-20-50-P-A-GF
25	170 826	DFM-12-25-P-A-GF	170 834	DFM-16-25-P-A-GF	170 845	DFM-20-80-P-A-GF	170 846	DFM-20-100-P-A-GF	–	–	–	–	–	
30	170 827	DFM-12-30-P-A-GF	170 835	DFM-16-30-P-A-GF	–	–	–	–	–	–	–	–	–	
40	170 828	DFM-12-40-P-A-GF	170 836	DFM-16-40-P-A-GF	–	–	–	–	–	–	–	–	–	
50	170 829	DFM-12-50-P-A-GF	170 837	DFM-16-50-P-A-GF	–	–	–	–	–	–	–	–	–	
80	170 830	DFM-12-80-P-A-GF	170 838	DFM-16-80-P-A-GF	–	–	–	–	–	–	–	–	–	
100	170 831	DFM-12-100-P-A-GF	170 839	DFM-16-100-P-A-GF	–	–	–	–	–	–	–	–	–	
125	–	–	–	–	–	–	–	–	–	–	–	–	–	
160	–	–	–	–	–	–	–	–	–	–	–	–	–	
200	–	–	–	–	–	–	–	–	–	–	–	–	–	
Gib [mm]		Ø bata 25 mm		Ø bata 32 mm		Ø bata 40 mm								
10	–	–	–	–	–	–	–	–	–	–	–	–	–	
20	170 847	DFM-25-20-P-A-GF	170 854	DFM-32-20-P-A-GF	170 864	DFM-40-25-P-A-GF	–	–	–	–	–	–	–	
25	170 848	DFM-25-25-P-A-GF	170 855	DFM-32-25-P-A-GF	–	–	–	–	–	–	–	–	–	
30	170 849	DFM-25-30-P-A-GF	170 856	DFM-32-30-P-A-GF	–	–	–	–	–	–	–	–	–	
40	170 850	DFM-25-40-P-A-GF	170 857	DFM-32-40-P-A-GF	–	–	–	–	–	–	–	–	–	
50	170 851	DFM-25-50-P-A-GF	170 858	DFM-32-50-P-A-GF	170 865	DFM-40-50-P-A-GF	170 866	DFM-40-80-P-A-GF	170 867	DFM-40-100-P-A-GF	170 868	DFM-40-125-P-A-GF	170 869	DFM-40-160-P-A-GF
80	170 852	DFM-25-80-P-A-GF	170 859	DFM-32-80-P-A-GF	170 870	DFM-40-200-P-A-GF	–	–	–	–	–	–	–	
100	170 853	DFM-25-100-P-A-GF	170 860	DFM-32-100-P-A-GF	–	–	–	–	–	–	–	–	–	
125	–	–	170 861	DFM-32-125-P-A-GF	–	–	–	–	–	–	–	–	–	
160	–	–	170 862	DFM-32-160-P-A-GF	–	–	–	–	–	–	–	–	–	
200	–	–	170 863	DFM-32-200-P-A-GF	–	–	–	–	–	–	–	–	–	
Gib [mm]		Ø bata 50 mm		Ø bata 63 mm		Ø bata 80 mm								
10	–	–	–	–	–	–	–	–	–	–	–	–	–	
20	–	–	–	–	–	–	–	–	–	–	–	–	–	
25	170 871	DFM-50-25-P-A-GF	170 878	DFM-63-25-P-A-GF	170 885	DFM-80-25-P-A-GF	170 886	DFM-80-50-P-A-GF	170 887	DFM-80-80-P-A-GF	170 888	DFM-80-100-P-A-GF	170 889	DFM-80-125-P-A-GF
30	–	–	–	–	–	–	–	–	–	–	–	–	–	
40	–	–	–	–	–	–	–	–	–	–	–	–	–	
50	170 872	DFM-50-50-P-A-GF	170 879	DFM-63-50-P-A-GF	170 890	DFM-80-160-P-A-GF	170 891	DFM-80-200-P-A-GF	–	–	–	–	–	
80	170 873	DFM-50-80-P-A-GF	170 880	DFM-63-80-P-A-GF	–	–	–	–	–	–	–	–	–	
100	170 874	DFM-50-100-P-A-GF	170 881	DFM-63-100-P-A-GF	–	–	–	–	–	–	–	–	–	
125	170 875	DFM-50-125-P-A-GF	170 882	DFM-63-125-P-A-GF	–	–	–	–	–	–	–	–	–	
160	170 876	DFM-50-160-P-A-GF	170 883	DFM-63-160-P-A-GF	–	–	–	–	–	–	–	–	–	
200	170 877	DFM-50-200-P-A-GF	170 884	DFM-63-200-P-A-GF	–	–	–	–	–	–	–	–	–	
Gib [mm]		Ø bata 100 mm												
10	–	–	–	–	–	–	–	–	–	–	–	–	–	
20	–	–	–	–	–	–	–	–	–	–	–	–	–	
25	170 892	DFM-100-25-P-A-GF	–	–	–	–	–	–	–	–	–	–	–	
30	–	–	–	–	–	–	–	–	–	–	–	–	–	
40	–	–	–	–	–	–	–	–	–	–	–	–	–	
50	170 893	DFM-100-50-P-A-GF	–	–	–	–	–	–	–	–	–	–	–	
80	170 894	DFM-100-80-P-A-GF	–	–	–	–	–	–	–	–	–	–	–	
100	170 895	DFM-100-100-P-A-GF	–	–	–	–	–	–	–	–	–	–	–	
125	170 896	DFM-100-125-P-A-GF	–	–	–	–	–	–	–	–	–	–	–	
160	170 897	DFM-100-160-P-A-GF	–	–	–	–	–	–	–	–	–	–	–	
200	170 898	DFM-100-200-P-A-GF	–	–	–	–	–	–	–	–	–	–	–	

 Osnovni program izdelkov

Vodilne enote DFM

Podatkovni list

FESTO

Podatki za naročanje – krogljučna vodila KF													
		Št. dela		Tip		Št. dela		Tip		Št. dela		Tip	
Gib [mm]		Ø bata 12 mm		Ø bata 16 mm		Ø bata 20 mm							
10	170 899	DFM-12-10-P-A-KF	170 907	DFM-16-10-P-A-KF	–	–	–	–	–	–	–	–	–
20	170 900	DFM-12-20-P-A-KF	170 908	DFM-16-20-P-A-KF	170 915	DFM-20-20-P-A-KF	–	–	–	–	–	–	–
25	170 901	DFM-12-25-P-A-KF	170 909	DFM-16-25-P-A-KF	170 916	DFM-20-25-P-A-KF	–	–	–	–	–	–	–
30	170 902	DFM-12-30-P-A-KF	170 910	DFM-16-30-P-A-KF	170 917	DFM-20-30-P-A-KF	–	–	–	–	–	–	–
40	170 903	DFM-12-40-P-A-KF	170 911	DFM-16-40-P-A-KF	170 918	DFM-20-40-P-A-KF	–	–	–	–	–	–	–
50	170 904	DFM-12-50-P-A-KF	170 912	DFM-16-50-P-A-KF	170 919	DFM-20-50-P-A-KF	–	–	–	–	–	–	–
80	170 905	DFM-12-80-P-A-KF	170 913	DFM-16-80-P-A-KF	170 920	DFM-20-80-P-A-KF	–	–	–	–	–	–	–
100	170 906	DFM-12-100-P-A-KF	170 914	DFM-16-100-P-A-KF	170 921	DFM-20-100-P-A-KF	–	–	–	–	–	–	–
125	–	–	–	–	–	–	–	–	–	–	–	–	–
160	–	–	–	–	–	–	–	–	–	–	–	–	–
200	–	–	–	–	–	–	–	–	–	–	–	–	–
Gib [mm]		Ø bata 25 mm		Ø bata 32 mm		Ø bata 40 mm							
10	–	–	–	–	–	–	–	–	–	–	–	–	–
20	170 922	DFM-25-20-P-A-KF	170 929	DFM-32-20-P-A-KF	–	–	–	–	–	–	–	–	–
25	170 923	DFM-25-25-P-A-KF	170 930	DFM-32-25-P-A-KF	170 939	DFM-40-25-P-A-KF	–	–	–	–	–	–	–
30	170 924	DFM-25-30-P-A-KF	170 931	DFM-32-30-P-A-KF	–	–	–	–	–	–	–	–	–
40	170 925	DFM-25-40-P-A-KF	170 932	DFM-32-40-P-A-KF	–	–	–	–	–	–	–	–	–
50	170 926	DFM-25-50-P-A-KF	170 933	DFM-32-50-P-A-KF	170 940	DFM-40-50-P-A-KF	–	–	–	–	–	–	–
80	170 927	DFM-25-80-P-A-KF	170 934	DFM-32-80-P-A-KF	170 941	DFM-40-80-P-A-KF	–	–	–	–	–	–	–
100	170 928	DFM-25-100-P-A-KF	170 935	DFM-32-100-P-A-KF	170 942	DFM-40-100-P-A-KF	–	–	–	–	–	–	–
125	–	–	170 936	DFM-32-125-P-A-KF	170 943	DFM-40-125-P-A-KF	–	–	–	–	–	–	–
160	–	–	170 937	DFM-32-160-P-A-KF	170 944	DFM-40-160-P-A-KF	–	–	–	–	–	–	–
200	–	–	170 938	DFM-32-200-P-A-KF	170 945	DFM-40-200-P-A-KF	–	–	–	–	–	–	–
Gib [mm]		Ø bata 50 mm		Ø bata 63 mm		Ø bata 80 mm							
10	–	–	–	–	–	–	–	–	–	–	–	–	–
20	–	–	–	–	–	–	–	–	–	–	–	–	–
25	170 946	DFM-50-25-P-A-KF	170 953	DFM-63-25-P-A-KF	170 960	DFM-80-25-P-A-KF	–	–	–	–	–	–	–
30	–	–	–	–	–	–	–	–	–	–	–	–	–
40	–	–	–	–	–	–	–	–	–	–	–	–	–
50	170 947	DFM-50-50-P-A-KF	170 954	DFM-63-50-P-A-KF	170 961	DFM-80-50-P-A-KF	–	–	–	–	–	–	–
80	170 948	DFM-50-80-P-A-KF	170 955	DFM-63-80-P-A-KF	170 962	DFM-80-80-P-A-KF	–	–	–	–	–	–	–
100	170 949	DFM-50-100-P-A-KF	170 956	DFM-63-100-P-A-KF	170 963	DFM-80-100-P-A-KF	–	–	–	–	–	–	–
125	170 950	DFM-50-125-P-A-KF	170 957	DFM-63-125-P-A-KF	170 964	DFM-80-125-P-A-KF	–	–	–	–	–	–	–
160	170 951	DFM-50-160-P-A-KF	170 958	DFM-63-160-P-A-KF	170 965	DFM-80-160-P-A-KF	–	–	–	–	–	–	–
200	170 952	DFM-50-200-P-A-KF	170 959	DFM-63-200-P-A-KF	170 966	DFM-80-200-P-A-KF	–	–	–	–	–	–	–
Gib [mm]		Ø bata 100 mm											
10	–	–											
20	–	–											
25	170 967	DFM-100-25-P-A-KF											
30	–	–											
40	–	–											
50	170 968	DFM-100-50-P-A-KF											
80	170 969	DFM-100-80-P-A-KF											
100	170 970	DFM-100-100-P-A-KF											
125	170 971	DFM-100-125-P-A-KF											
160	170 972	DFM-100-160-P-A-KF											
200	170 973	DFM-100-200-P-A-KF											

Vodilne enote DFM-B

Pregled periferije

FESTO

Pogoni z linearnimi vodilji
Palična vodila

6.2

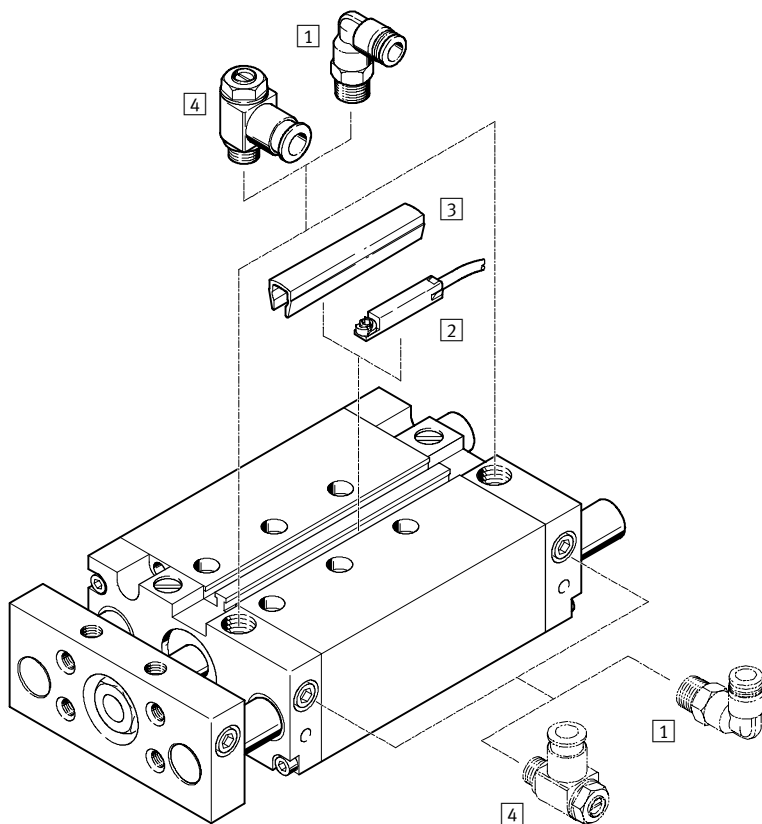

DFM-B-16-P

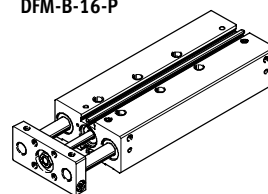

DFM-B-16-P-AJ

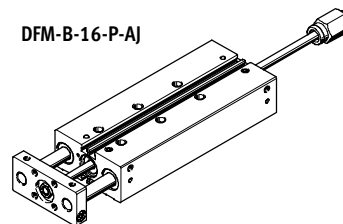

Variante

AJ

EJ

AJ + EJ

YSRW

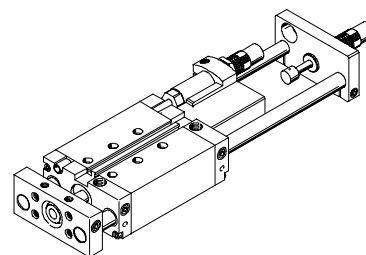
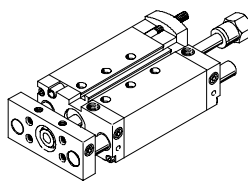
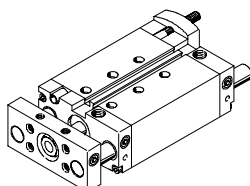
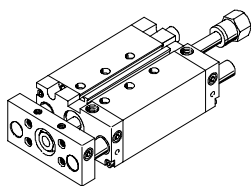

Pribor	Kratek opis	→ Stran
1 Vtično navojni priključek QS	za priključitev cevi za stisnjen zrak s toleranco zunanje mere	Zvezek 3 www.festo.com
2 Mejna stikala SME-/SMT-8	z možnostjo integracije v profilno cev	1 / 6.2-104
3 Pokrov utora ABP-5-S	za zaščito kabla senzorja in utorov za senzorje pred onesnaženjem	1 / 6.2-105
4 Povratno dušilni ventil GRLA	za regulacijo hitrosti	1 / 6.2-105
- Centrirne puše ZBH	V obsegu dobave vsebovano 4 oz. 6 kosov	1 / 6.2-104

Vodilne enote DFM-B

Ključ tipov

FESTO

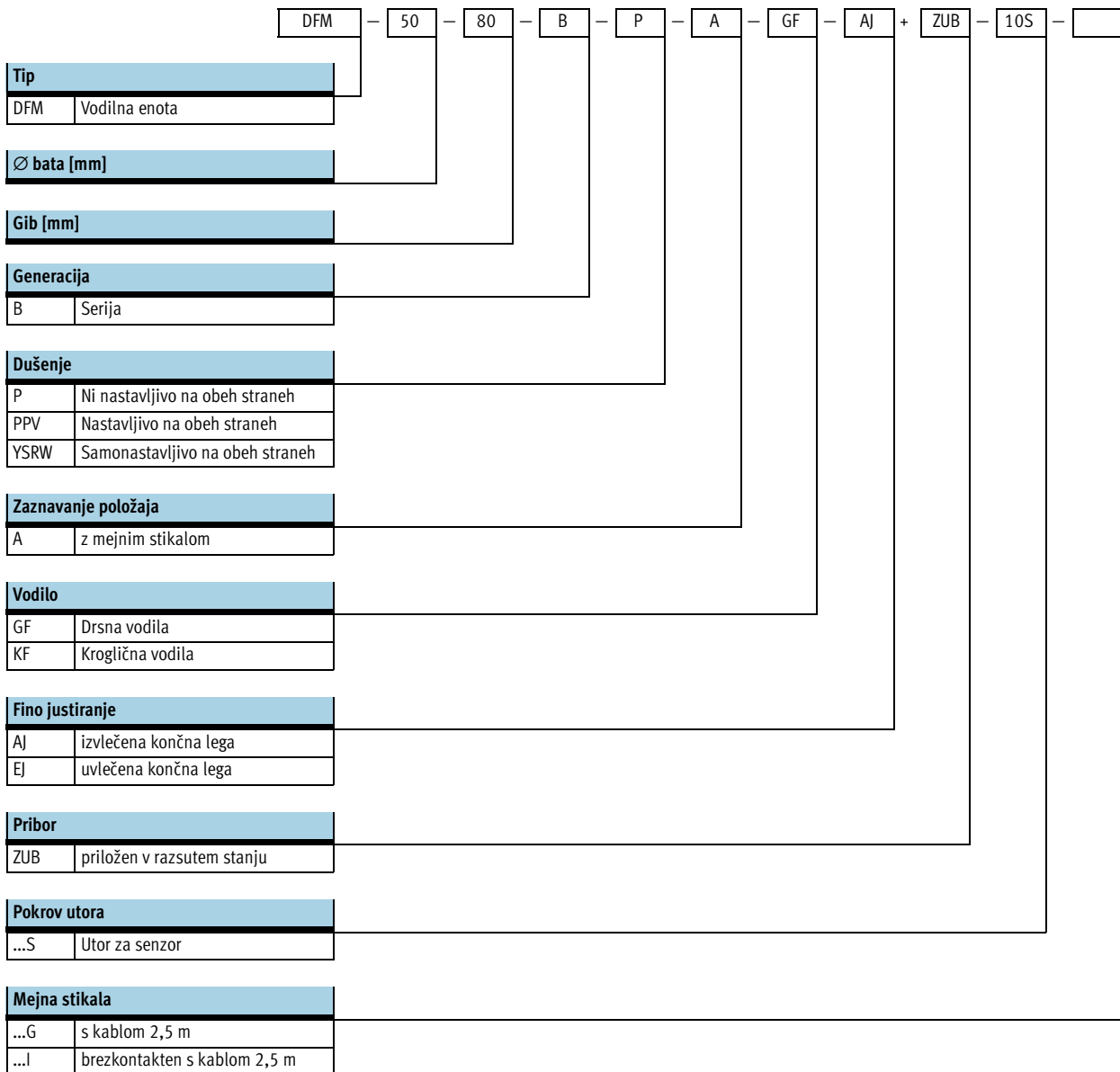

Vodilne enote DFM-B

Podatkovni list

FESTO

Funkcija

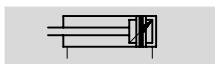
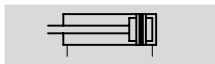

Servisiranje

Ø bata 20 ... 40 mm

Ø - Premer
12 ... 63 mm

— - Dolžina giba
10 ... 400 mm

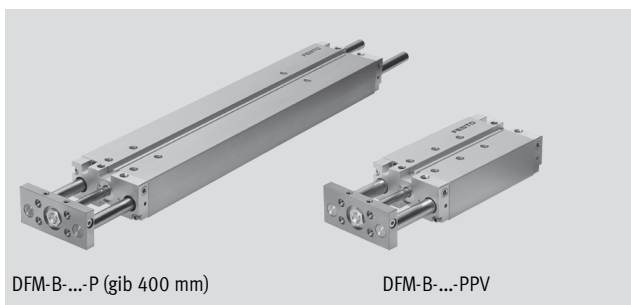

DFM-B-...-P (gib 400 mm)

DFM-B-...-PPV

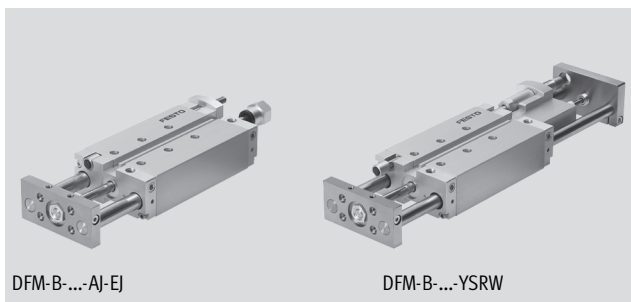

DFM-B-...-AJ-EJ

DFM-B-...-YSRW

Splošni tehnični podatki								
Ø bata	12	16	20	25	32	40	50	63
Pnevmatični priključek	M5	M5	M5	G1/8	G1/8	G1/8	G1/4	G1/4
Obratovalni medij	Filtriran stisnjen zrak, naoljen ali nenaoljen							
Obratovalni tlak [bar]	2 ... 10	2 ... 10	2 ... 10	1,5 ... 10	1,5 ... 10	1,5 ... 10	1 ... 10	1 ... 10
Konstrukcija	Bat							
	Batnica							
	Vodilni drogovi z jarmom							
Dušenje	na obeh straneh ni nastavlljivo							
	—	nastavlljivo na obeh straneh						
	—	—	samonastavlljivo na obeh straneh					
Dolžina dušenja (PPV) [mm]	—	12	15	15	16	17	19	19
Zaznavanje položaja	z mejnim stikalom							
Način pritrditve	s skožnjo izvrtino							
	z notranjim navojem							
Vgradna lega	poljubna							
Varovanje pred zasukom/vodilo	Vodilni drog z jarmom/drsno ali kroglično voden							
Varianta AJ, EJ in YSRW								
Območje nastavljanja [mm]	0 ... 10							
Varianta YSRW z blažilnikom								
Ponovljivost [mm]	—	—	maks. 0,05	maks. 0,05	maks. 0,05	maks. 0,05	maks. 0,05	maks. 0,05

Pogoji okolja	Drсна vodila GF	Kroglična vodila KF	Varianta YSRW z blažilnikom
Temperatura okolice ¹⁾ [°C]	-20 ... +80	-5 ... +60	0 ... +60
Obstojnost proti koroziji KBK ²⁾	2	—	—

1) Upoštevati uporabno območje približevalnega stikala.

2) Razred odpornosti proti koroziji 1 po Festo standardu 940 070

Deli z majhno korozijsko obremenitvijo. Transportna in skladiščna zaščita. Deli brez prednostnih dekorativnih zahtev za površine npr. v nevidni notranjosti ali za pokrovi.

Razred odpornosti proti koroziji 2 po Festo standardu 940 070

deli z zmerno korozijsko obremenitvijo. Vidni deli na zunanji strani s prednostno dekorativno nalogo površine, ki so v neposrednem stiku z običajno industrijsko atmosfero oz. mediji, kot so npr. mazalno-hladilna sredstva.

Vodilne enote DFM-B

Podatkovni list

FESTO

Hitrosti [m/s]								
Ø bata	12	16	20	25	32	40	50	63
Dušenje P, fina nastavev giba AJ in EJ								
Maksimalna hitrost izvlečenja	0,8	0,8	0,8	0,8	0,8	0,8	0,6	0,6
Maksimalna hitrost uvlečenja	0,8	0,8	0,8	0,8	0,8	0,8	0,6	0,6
Dušenje PPV, YSRW								
Maksimalna hitrost izvlečenja	–	1,5	1,5	1,5	1,5	1,5	1,0	1,0
Maksimalna hitrost uvlečenja	–	1,5	1,5	1,5	1,5	1,5	1,0	1,0

Sile [N]								
Ø bata	12	16	20	25	32	40	50	63
Dušenje P, PPV, YSRW, fina nastavev giba EJ								
Teoretična sila pri 6 bar, gib naprej	68	121	188	295	482	754	1 178	1 870
Teoretična sila pri 6 bar, gib nazaj	51	90	141	247	415	686	1 057	1 750
Fina nastavev giba AJ in AJ+EJ								
Teoretična sila pri 6 bar, gib naprej	51	90	141	247	415	686	1 057	1 750
Teoretična sila pri 6 bar, gib nazaj	51	90	141	247	415	686	1 057	1 750

Udarne energije [J]								
Ø bata	12	16	20	25	32	40	50	63
Dušenje P								
Maks. udarna energija v končnih legah	0,09	0,15	0,2	0,35	0,40	0,7	1,0	1,3
Dušenje YSRW								
Maks. prevzemanje energije na gib	–	–	4	8	12	35	35	70
Maks. prevzemanje energije na uro	–	–	21 000	30 000	41 000	68 000	68 000	100 000

Dopustna naletna hitrost:

$$v_{zul.} = \sqrt{\frac{2 \times E_{zul.}}{m_{Eigen} + m_{Last}}}$$

Maksimalna dopustna masa:

$$m_{Last} = \frac{2 \times E_{zul.}}{v^2} - m_{Eigen}$$

 Opozorilo

Ti podatki predstavljajo maksimalne dosegljive vrednosti. V praksi lahko te vrednosti nihajo glede na maso koristnega bremena. Nadalje je

potrebno upoštevati mejne vrednosti zmožnosti dušenja pogonskega valja ter dopustno udarno energijo.

Vodilne enote DFM-B

Podatkovni list

FESTO

Pogoni z linearnimi vodili
Palična vodila

6.2

DFM-B z drsnimi vodili GF, dušenje P, PPV								
Gib [mm]	Ø bata [mm]							
	12	16	20	25	32	40	50	63
Masa izdelka [g]								
10	385	621	–	–	–	–	–	–
20	432	680	1 026	1 474	2 163	–	–	–
25	452	706	1 068	1 530	2 238	2 606	4 290	5 568
30	476	736	1 109	1 586	2 337	–	–	–
40	523	795	1 215	1 726	2 489	–	–	–
50	570	854	1 298	1 838	2 640	3 047	5 019	6 457
80	712	1 033	1 572	2 218	3 210	3 663	5 909	7 503
100	803	1 148	1 733	2 435	3 502	3 981	6 376	8 116
125	962	1 352	2 000	2 800	4 018	4 534	7 151	9 050
160	1 128	1 560	2 293	3 193	4 549	5 118	8 017	10 137
200	1 318	1 797	2 628	3 642	5 158	5 786	9 007	11 379
250	–	–	3 237	4 430	6 259	6 962	10 813	13 509
320	–	–	3 823	5 215	7 322	8 129	12 545	15 682
400	–	–	4 493	6 113	8 537	9 462	14 525	18 165
Gibajoče se mase [g]								
10	201	283	–	–	–	–	–	–
20	216	302	506	715	1 147	–	–	–
25	223	312	520	734	1 176	1 305	2 217	2 640
30	230	322	534	753	1 230	–	–	–
40	245	342	586	823	1 289	–	–	–
50	260	362	615	861	1 347	1 476	2 567	2 990
80	304	423	724	1 022	1 644	1 776	3 002	3 426
100	333	463	781	1 098	1 764	1 893	3 189	3 613
125	420	579	917	1 289	2 059	2 188	3 586	4 009
160	472	649	1 016	1 422	2 264	2 393	3 913	4 336
200	530	730	1 129	1 573	2 499	2 627	4 286	4 710
250	–	–	1 489	2 017	3 164	3 293	5 351	5 774
320	–	–	1 688	2 283	3 574	3 703	6 005	6 428
400	–	–	1 914	2 587	4 042	4 171	6 752	7 176

Vodilne enote DFM-B

Podatkovni list

FESTO

DFM-B s krogličnimi vodili KF, dušenje P, PPV								
Gib [mm]	Ø bata [mm]							
	12	16	20	25	32	40	50	63
Masa izdelka [g]								
10	345	543	–	–	–	–	–	–
20	388	596	935	1 395	1 932	–	–	–
25	405	619	974	1 447	1 998	2 366	3 907	5 185
30	427	647	1 012	1 499	2 079	–	–	–
40	470	700	1 105	1 624	2 213	–	–	–
50	513	754	1 181	1 729	2 346	2 753	4 523	5 961
80	641	916	1 428	2 074	2 817	3 270	5 272	6 865
100	723	1 020	1 577	2 276	3 073	3 552	5 682	7 423
125	852	1 190	1 809	2 599	3 490	4 006	6 327	8 226
160	1 002	1 378	2 079	2 966	3 958	4 526	7 094	9 214
200	1 174	1 593	2 388	3 384	4 494	5 121	7 971	10 343
250	–	–	2 905	4 073	5 369	6 072	9 419	12 115
320	–	–	3 445	4 805	6 305	7 112	10 953	14 091
400	–	–	4 063	5 642	7 376	8 301	12 707	16 347
Gibajoče se mase [g]								
10	168	239	–	–	–	–	–	–
20	178	254	437	631	933	–	–	–
25	183	261	447	646	954	1 082	1 830	2 254
30	188	268	458	661	990	–	–	–
40	198	283	498	716	1 030	–	–	–
50	208	297	520	746	1 071	1 199	2 067	2 491
80	238	341	602	873	1 271	1 400	2 361	2 785
100	259	370	646	934	1 352	1 481	2 492	2 915
125	316	452	748	1 083	1 548	1 677	2 758	3 182
160	352	503	824	1 189	1 690	1 819	2 986	3 410
200	392	561	911	1 310	1 852	1 981	3 247	3 671
250	–	–	1 180	1 656	2 291	2 420	3 953	4 377
320	–	–	1 332	1 868	2 575	2 703	4 410	4 833
400	–	–	1 505	2 111	2 899	3 027	4 931	5 355

Pogoni z linearnimi vodili
Palična vodila

6.2

Vodilne enote DFM-B

Podatkovni list

FESTO

Dodatne mase pri fini nastavitvi giba AJ – GF, KF

Pri uporabi fine nastavitve giba AJ je potrebno poleg mas, omenjenih od strani 1 / 6.2-76 upoštevati naslednjo maso.

Masa izdelka [g] fine nastavitve giba AJ (batnica + prislon)								
Gib [mm]	Ø bata [mm]							
	12	16	20	25	32	40	50	63
10	55,4	58,8	–	–	–	–	–	–
20	57,6	61	75,6	115,4	185,7	–	–	–
25	58,7	62,1	77,6	118,5	190,2	188,7	350,7	350,5
30	59,9	63,3	79,6	121,6	194,7	–	–	–
40	62,1	65,5	83,6	127,8	203,6	–	–	–
50	64,3	67,7	87,5	134	212,5	211	390,4	390,2
80	71	74,4	99,5	152,6	239,3	237,8	438	437,8
100	75,5	78,9	107,5	165	257,2	255,7	469,8	469,6
125	81,1	84,5	117,3	180,5	279,5	278	509,5	509,3
160	88,9	92,3	131,2	202,5	310,8	309,3	565,1	564,9
200	97,8	101,2	147,1	227	346,5	345	628,6	628,4
250	–	–	167	258,1	391,2	389,7	708,1	707,9
320	–	–	194,8	301,5	453,8	452,3	819,2	819
400	–	–	226,5	351,1	525,2	523,7	946,3	946,1

Gibljava masa [g] fine nastavitve giba AJ (batnica + prislon)								
Gib [mm]	Ø bata [mm]							
	12	16	20	25	32	40	50	63
10	51,5	52,3	–	–	–	–	–	–
20	53,7	54,5	76	116,6	185,9	–	–	–
25	54,8	55,6	78	119,7	190,4	190	351,7	351,7
30	56	56,8	80	122,8	194,9	–	–	–
40	58,2	59	84	129	203,8	–	–	–
50	60,4	61,2	87,9	135,2	212,7	212,7	391,4	391,4
80	67,1	67,9	99,9	153,8	239,5	239,5	439	439
100	71,6	72,4	107,8	166,2	257,4	257,4	470,8	470,8
125	77,2	78	117,7	181,7	279,7	279,7	510,5	510,5
160	85	85,8	131,6	203,4	311	311	566,1	566,1
200	93,9	94,7	147,5	228,2	346,7	346,7	629,6	629,6
250	–	–	167,4	259,3	391,4	391,4	709,1	709,1
320	–	–	195,2	302,7	454	454	820,2	820,2
400	–	–	226,9	352,3	525,4	525,4	947,3	947,3

Vodilne enote DFM-B

Podatkovni list

FESTO

Dodatne mase pri fini nastavitvi giba EJ – GF, KF

Pri uporabi fine nastavitve giba EJ je potrebno poleg mas, omenjenih od strani 1 / 6.2-76 upoštevati naslednjo maso.

Masa izdelka [g] fine nastavitve giba EJ (batnica + prislon)						
Gib [mm]	Ø bata [mm]					
	20	25	32	40	50	63
20	55,7	117,1	134,1	–	–	–
25	56,4	119,1	136,1	153,9	302,8	354
30	57,2	121	138	–	–	–
40	58,8	125	142	–	–	–
50	60,3	129	146	163,8	318,3	369,5
80	65	140,9	157,9	175,7	336,9	388,1
100	68,1	148,8	165,8	183,6	349,4	400,6
125	71,9	158,8	175,8	193,6	364,9	416,1
160	77,4	172,7	189,7	207,5	386,6	437,8
200	83,6	188,5	205,5	223,3	411,4	462,6
250	91,3	208,4	225,4	243,2	442,4	493,6
320	102,2	236,2	253,2	271	485,9	537,1
400	114,6	268	285	302,8	535,5	586,7

DFM-B s krogljčnimi vodili KF, dušenje YSRW						
Gib [mm]	Ø bata [mm]					
	20	25	32	40	50	63
Masa izdelka [g]						
20	1 684	2 641	3 717	–	–	–
25	1 733	2 707	3 801	4 995	7 594	10 816
30	1 780	2 773	3 884	–	–	–
40	1 874	2 903	4 053	–	–	–
50	1 970	3 035	4 222	5 455	8 275	11 657
80	2 257	3 429	4 720	5 999	9 092	12 629
100	2 444	3 687	5 047	6 352	9 614	13 298
125	2 677	4 008	5 458	6 801	10 294	14 137
160	3 015	4 473	6 050	7 446	11 255	15 319
200	3 401	5 004	6 728	8 183	12 354	16 670
250	3 855	5 641	7 545	9 074	13 700	18 340
320	4 530	6 569	8 730	10 363	15 623	20 704
400	5 302	7 631	10 085	11 837	17 821	23 405
Gibajoče se mase [g]						
20	874	1 323	1 933	–	–	–
25	894	1 350	1 969	2 386	3 735	4 996
30	914	1 378	2 005	–	–	–
40	953	1 432	2 077	–	–	–
50	993	1 487	2 149	2 566	4 021	5 282
80	1 111	1 650	2 365	2 782	4 365	5 625
100	1 190	1 759	2 509	2 926	4 594	5 855
125	1 289	1 896	2 690	3 106	4 880	6 141
160	1 427	2 087	2 942	3 359	5 281	6 542
200	1 585	2 305	3 230	3 647	5 739	7 000
250	1 782	2 578	3 590	4 007	6 312	7 572
320	2 059	2 959	4 095	4 512	7 114	8 374
400	2 375	3 396	4 671	5 088	8 030	9 290

Pogoni z linearnimi vodili
Palična vodila

6.2

Vodilne enote DFM-B

Podatkovni list



Materiali

Funkcijski prerez

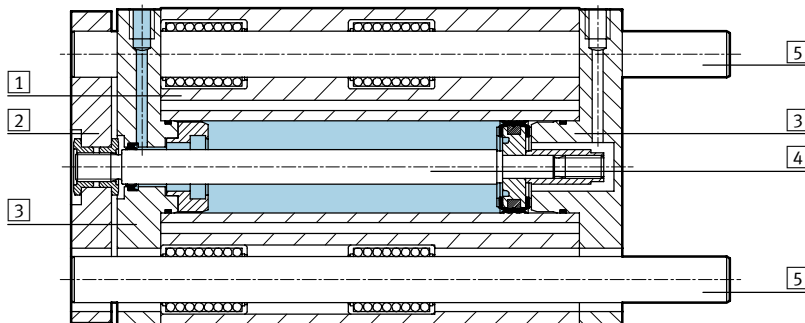

Variante	Drsna vodila GF	Kroglična vodila KF
1 Ohišje	Al zlitina za kovanje, eloksirana	Al zlitina za kovanje, eloksirana
2 Plošča jarma	jeklo za poboljšanje	jeklo za poboljšanje
3 Ležajni in zaključni pokrov	Al zlitina za kovanje, eloksirana	Al zlitina za kovanje, eloksirana
4 Batnica	visokolegirano nerjavno jeklo	visokolegirano nerjavno jeklo
5 Vodilni drogovi	visokolegirano nerjavno jeklo	jeklo za poboljšanje
- Statična tesnila	nitrikkavčuk	nitrikkavčuk
- Dinamična tesnila	poliuretan	poliuretan
- Mazalno sredstvo	Klüberplex BE 31-102	Klüberplex BE 31-102
Opomba za material	-	Brez bakra, PTFE in silikonov

Maksimalna koristna obremenitev F [N]

Drsna vodila GF in kroglična vodila KF

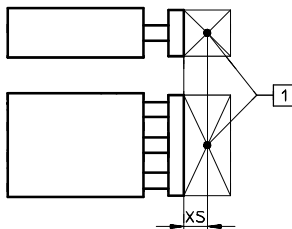

1 Masno središče koristnega bremena

Ø bata [mm]		XS [mm]	Gib [mm]													
			10	20	25	30	40	50	80	100	125	160	200	250	320	400
12	GF	25	53	47	45	43	39	36	28	25	23	20	15	-	-	-
	KF		47	42	40	38	35	32	26	23	20	16	13	-	-	-
16	GF	50	95	86	83	79	73	67	55	49	37	30	25	-	-	-
	KF		75	69	66	64	58	56	51	48	30	21	17	-	-	-
20	GF	50	-	99	96	92	110	103	86	77	71	63	55	47	41	35
	KF		-	80	77	75	91	88	80	75	65	56	47	40	34	29
25	GF	50	-	121	116	112	123	115	96	86	86	76	67	53	45	39
	KF		-	88	86	84	100	97	89	85	80	66	56	46	38	32
32	GF	50	-	188	180	173	161	150	166	150	168	146	127	106	91	78
	KF		-	120	118	116	112	109	134	128	144	135	126	135	125	100
40	GF	50	-	-	180	-	-	150	166	150	168	146	127	106	91	78
	KF		-	-	118	-	-	109	134	128	144	135	126	135	125	100
50	GF	50	-	-	257	-	-	216	234	212	229	200	174	145	124	105
	KF		-	-	182	-	-	168	201	193	211	199	188	179	158	130
63	GF	50	-	-	257	-	-	216	234	212	229	200	174	145	124	105
	KF		-	-	182	-	-	168	201	193	211	199	188	179	158	130

Vodilne enote DFM-B

Podatkovni list

FESTO

Dopustna momentna obremenitev M [Nm]

Drsna vodila GF in kroglična vodila KF

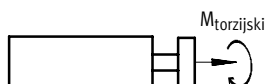

Ø bata [mm]		Gib [mm]													
		10	20	25	30	40	50	80	100	125	160	200	250	320	400
12	GF	1,10	0,95	0,90	0,85	0,80	0,75	0,60	0,50	0,45	0,40	0,30	-	-	-
	KF	0,95	0,85	0,80	0,75	0,70	0,65	0,50	0,45	0,40	0,30	0,25	-	-	-
16	GF	2,20	2,00	1,90	1,80	1,70	1,50	1,30	1,10	0,85	0,70	0,60	-	-	-
	KF	1,70	1,60	1,50	1,45	1,35	1,30	1,20	1,10	0,70	0,50	0,40	-	-	-
20	GF	-	2,90	2,80	2,70	3,20	3,00	2,50	2,20	2,10	1,80	1,60	1,40	1,20	1,00
	KF	-	2,30	2,20	2,15	2,60	2,55	2,30	2,20	1,90	1,60	1,40	1,20	1,00	0,85
25	GF	-	4,15	3,95	3,80	4,20	3,90	3,25	2,90	2,90	2,60	2,30	1,80	1,50	1,30
	KF	-	3,00	2,92	2,85	3,40	3,30	3,02	2,89	2,70	2,20	1,90	1,50	1,30	1,10
32	GF	-	7,30	7,00	6,70	6,20	5,80	6,40	5,80	6,50	5,70	5,00	4,10	3,50	3,00
	KF	-	4,70	4,60	4,55	4,40	4,25	5,25	5,00	5,60	5,25	4,90	5,20	4,80	3,90
40	GF	-	-	7,90	-	-	6,55	7,25	6,55	7,35	6,40	5,55	4,60	4,0	3,40
	KF	-	-	5,20	-	-	4,80	5,90	5,65	6,35	5,95	5,55	5,95	5,50	4,40
50	GF	-	-	14,15	-	-	11,85	12,85	11,65	12,55	11,00	9,60	7,98	6,82	5,78
	KF	-	-	10,00	-	-	9,30	11,00	10,6	11,60	11,00	10,30	9,82	8,67	7,17
63	GF	-	-	15,90	-	-	13,30	14,45	13,10	14,10	12,30	10,70	9,06	7,75	6,56
	KF	-	-	11,30	-	-	10,50	12,50	12,00	13,20	12,40	11,70	11,16	9,85	8,15

Vzvojna zračnost p

Drsna vodila GF in kroglična vodila KF v uvlečenem stanju, neobremenjena

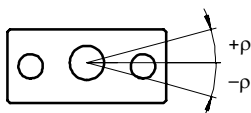

Ø bata		12	16	20	25	32	40	50	63
Vzvojna zračnost [°]	GF	0,09	0,09	0,07	0,07	0,06	0,06	0,05	0,05
	KF	0,08	0,08	0,07	0,07	0,05	0,05	0,05	0,05

Vodilne enote DFM-B

Podatkovni list



Odklon batnice

Srednji odklon f_1 zaradi zračnosti ležaja v odvisnosti od giba l

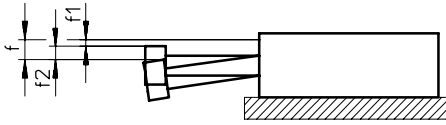

- $f = f_1 + f_2$
- f = skupni odklon batnice
- f_1 = odklon zaradi zračnosti ležaja
- f_2 = odklon zaradi prečne sile

DFM-GF z dvema ležajema na vodilni drog

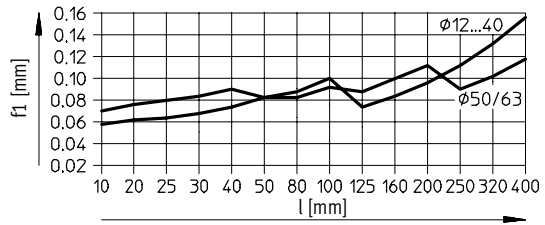

Odklon f_2 zaradi prečne sile F v odvisnosti od giba pri drsnih vodilih GF

Gib 50 mm

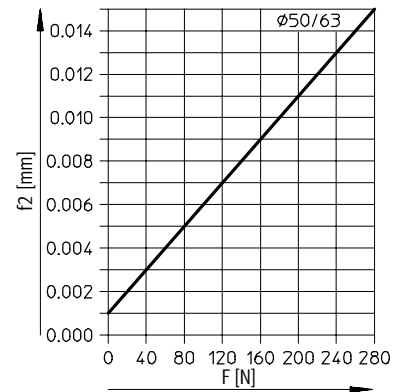
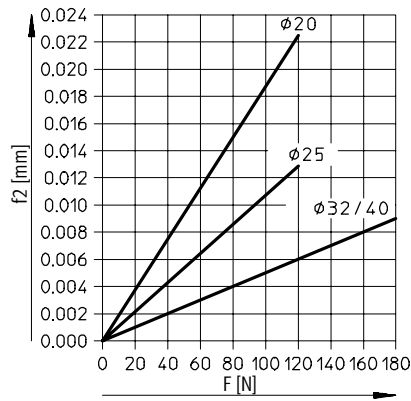
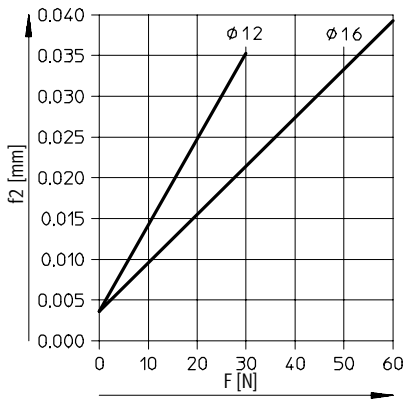

Gib 100 mm

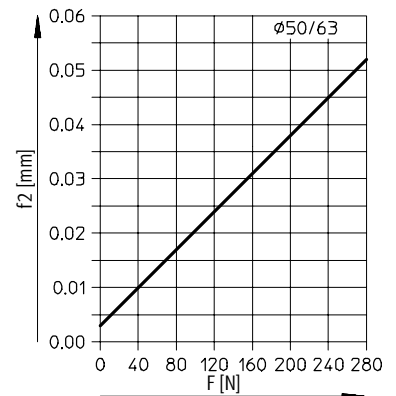
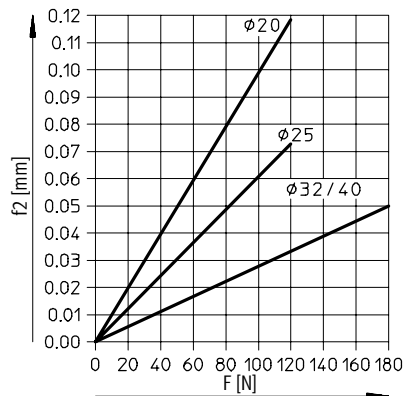
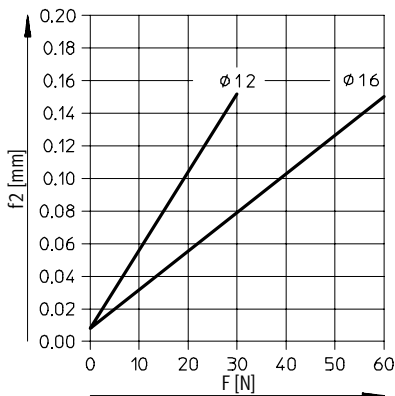

Vodilne enote DFM-B

Podatkovni list

FESTO

Odklon f_2 zaradi prečne sile F v odvisnosti od giba pri drsnih vodilih GF

Gib 200 mm

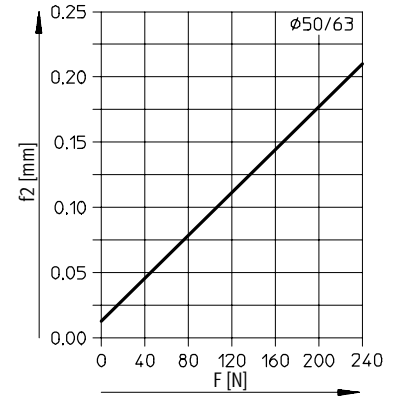
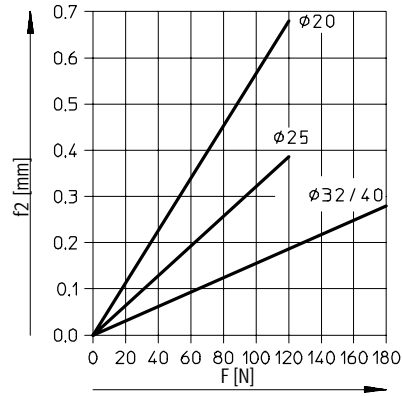
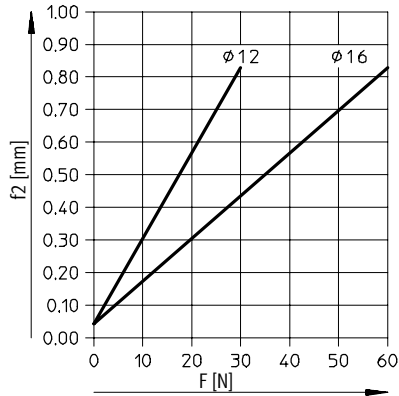

Gib 400 mm

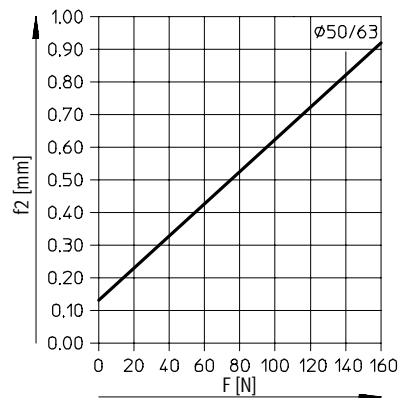
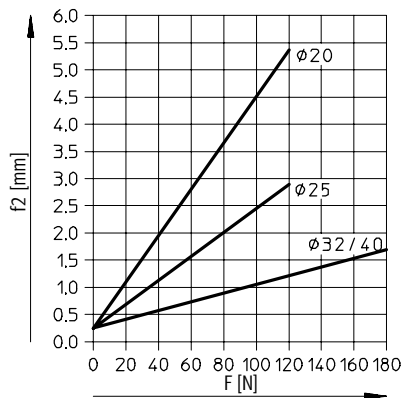

Vodilne enote DFM-B

Podatkovni list



Odklon batnice

Srednji odklon f_1 zaradi zračnosti ležaja v odvisnosti od giba l

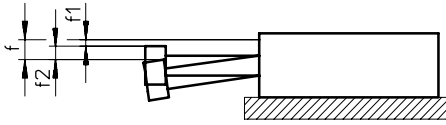

- $f = f_1 + f_2$
- f = skupni odklon batnice
- f_1 = odklon zaradi zračnosti ležaja
- f_2 = odklon zaradi prečne sile

DFM-KF z dvema ležajema na vodilni drog

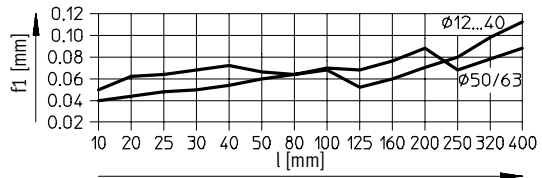

Odklon f_2 zaradi prečne sile F v odvisnosti od giba pri krogličnih vodilih KF

Gib 50 mm

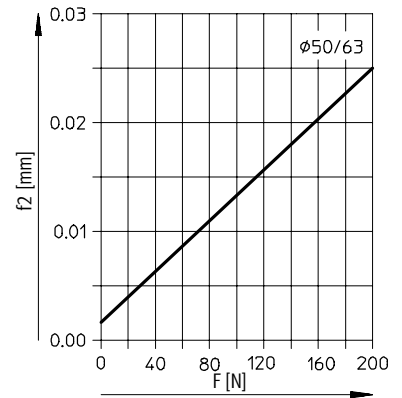
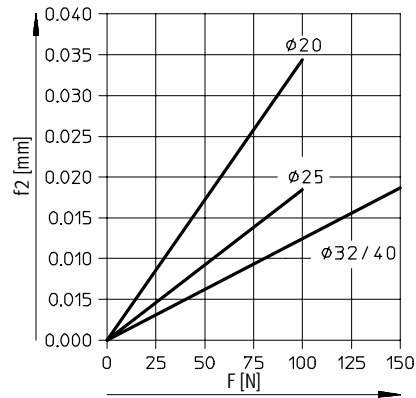
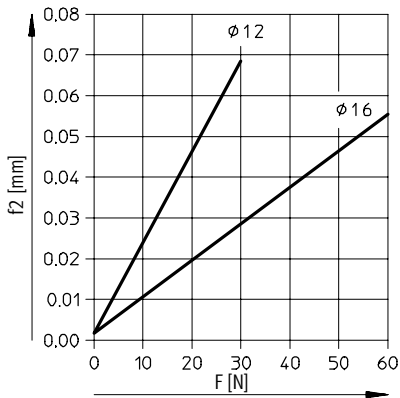

Gib 100 mm

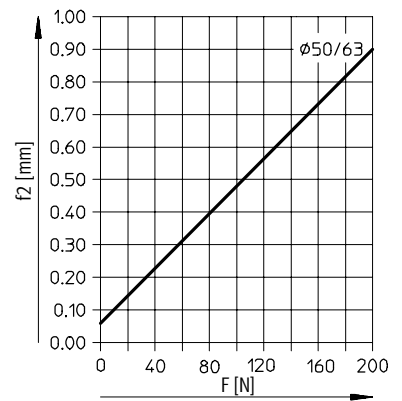
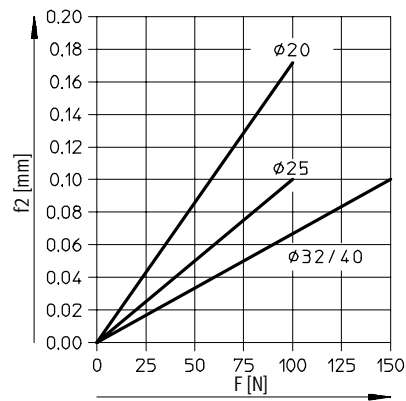
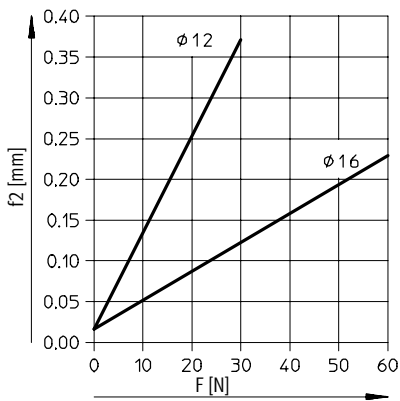

Vodilne enote DFM-B

Podatkovni list

FESTO

Odklon f_2 zaradi prečne sile F v odvisnosti od giba pri krogljčnih vodilih KF

Gib 200 mm

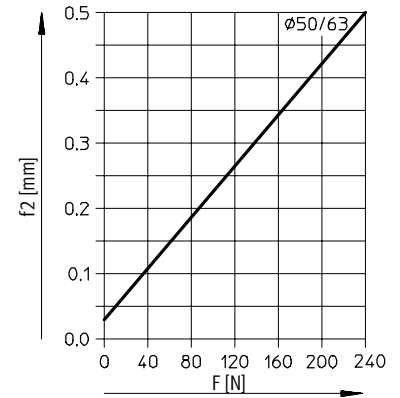
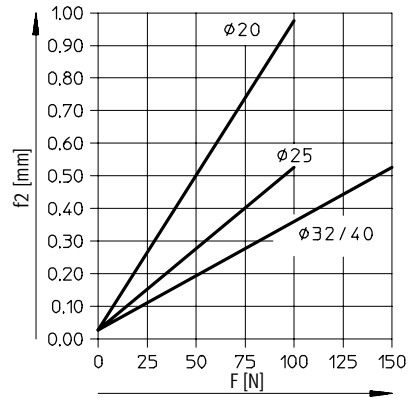
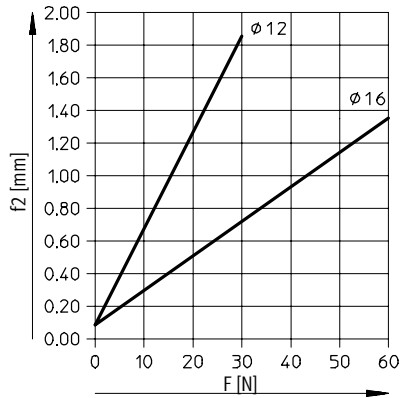

Gib 400 mm

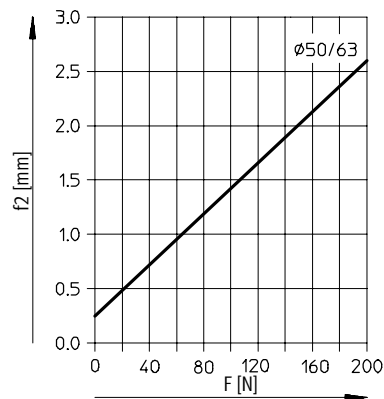
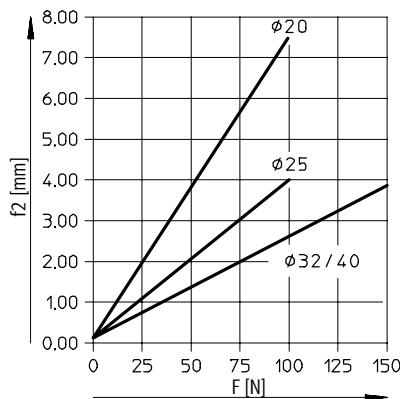

Pogoni z linearnimi vodili
Palična vodila

6.2

Vodilne enote DFM-B

Podatkovni list



Uporaba kot dvizni valj

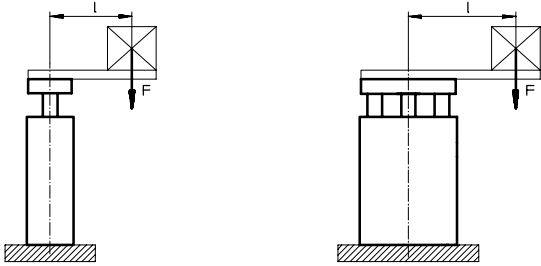

- - Opozorilo

Dodatni diagrami → od strani 1 / 6.2-58.

F = vzdolžna sila [N]

L = ročica [mm]

Dopustna obremenitev kot drsna vodila GF

Gib 40 ... 400 mm

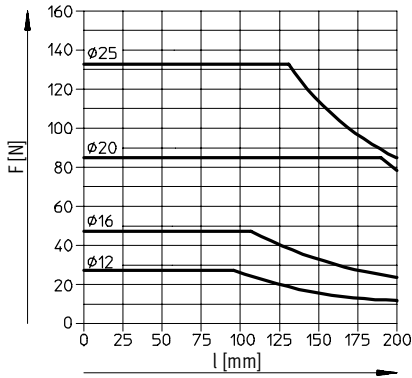

Gib 250 ... 400 mm

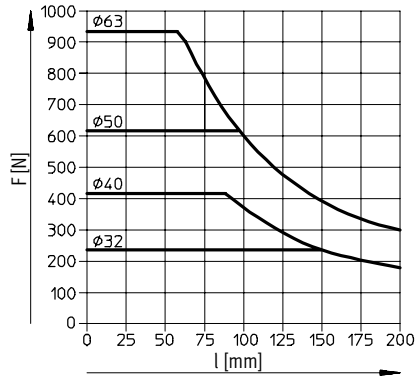

Vodilne enote DFM-B

Podatkovni list

Dopustna obremenitev s krogličnimi vodili KF

Gib 40 ... 100 mm

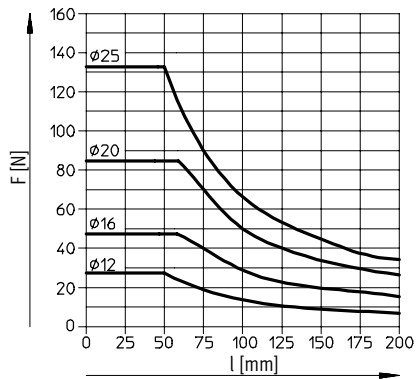

Gib 125 ... 200 mm

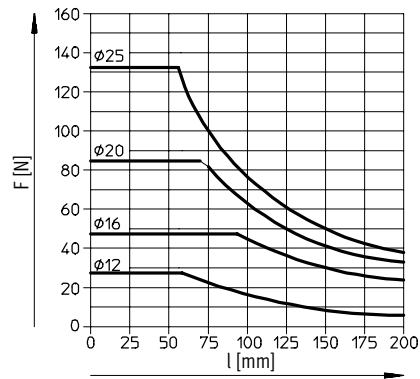

Gib 250 ... 400 mm

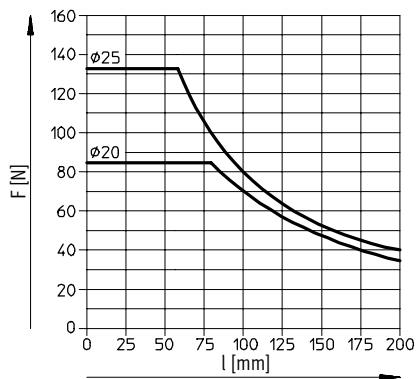

Gib 200 ... 400 mm

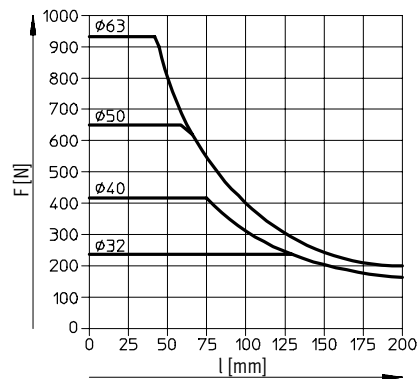

Vodilne enote DFM-B

Podatkovni list



Dopustna masa bremena m v odvisnosti od dopustne hitrosti v

Vodoravni gib, dušenje YSRW

DFM-20-...-B-YSRW

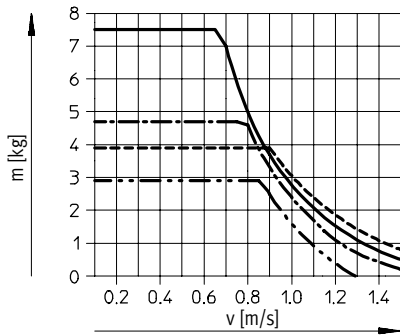

DFM-25-...-B-YSRW

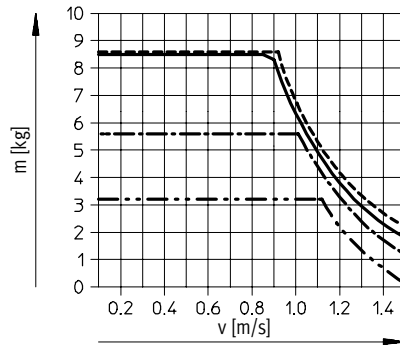

DFM-32-...-B-YSRW

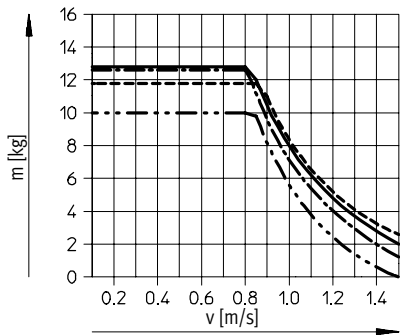

DFM-40-...-B-YSRW

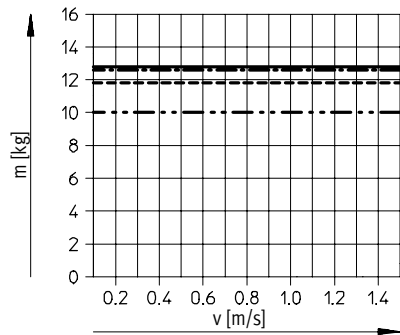

DFM-50-...-B-YSRW

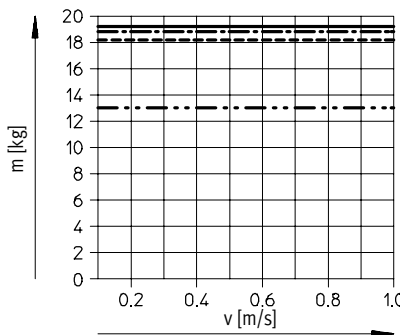

DFM-63-...-B-YSRW

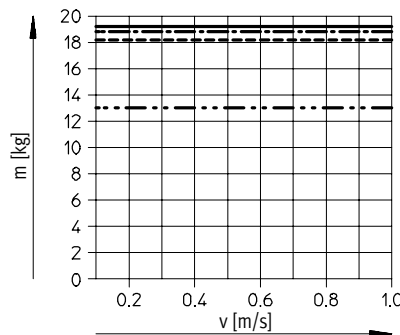

- Gib 25 mm
- Gib 100 mm
- · - · - Gib 200 mm
- Gib 400 mm

Vodilne enote DFM-B

Podatkovni list

Navpični gib, dušenje YSRW

DFM-20-...-B-YSRW

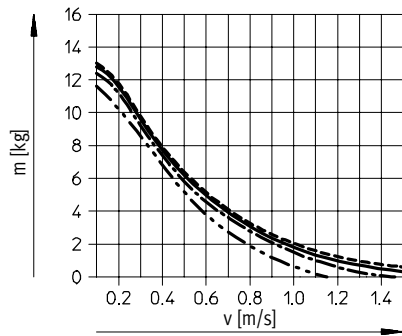

DFM-25-...-B-YSRW

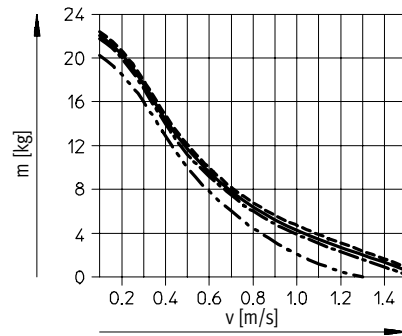

DFM-32-...-B-YSRW

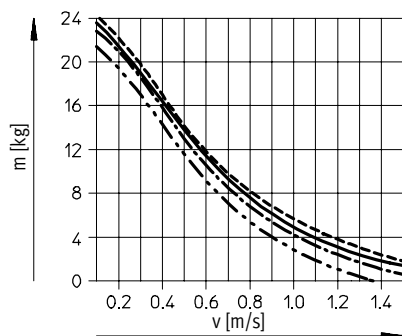

DFM-40-...-B-YSRW

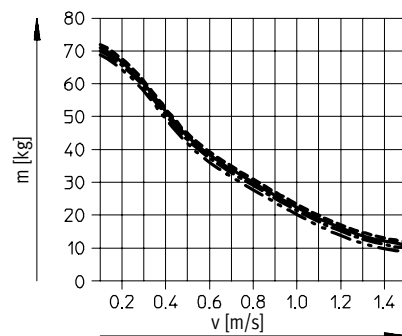

DFM-50-...-B-YSRW

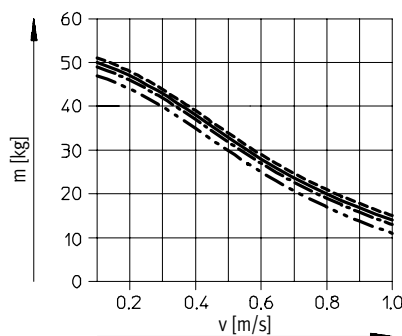

DFM-63-...-B-YSRW

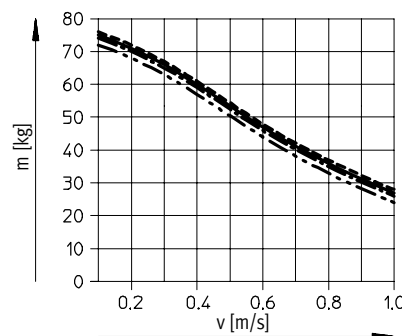

- Gib 25 mm
- Gib 100 mm
- · - · - Gib 200 mm
- Gib 400 mm

Vodilne enote DFM-B

Podatkovni list

FESTO

Dimenzije

Ø bata 12, 16 mm

Prenos CAD-datotek → www.festo.com/de/engineering

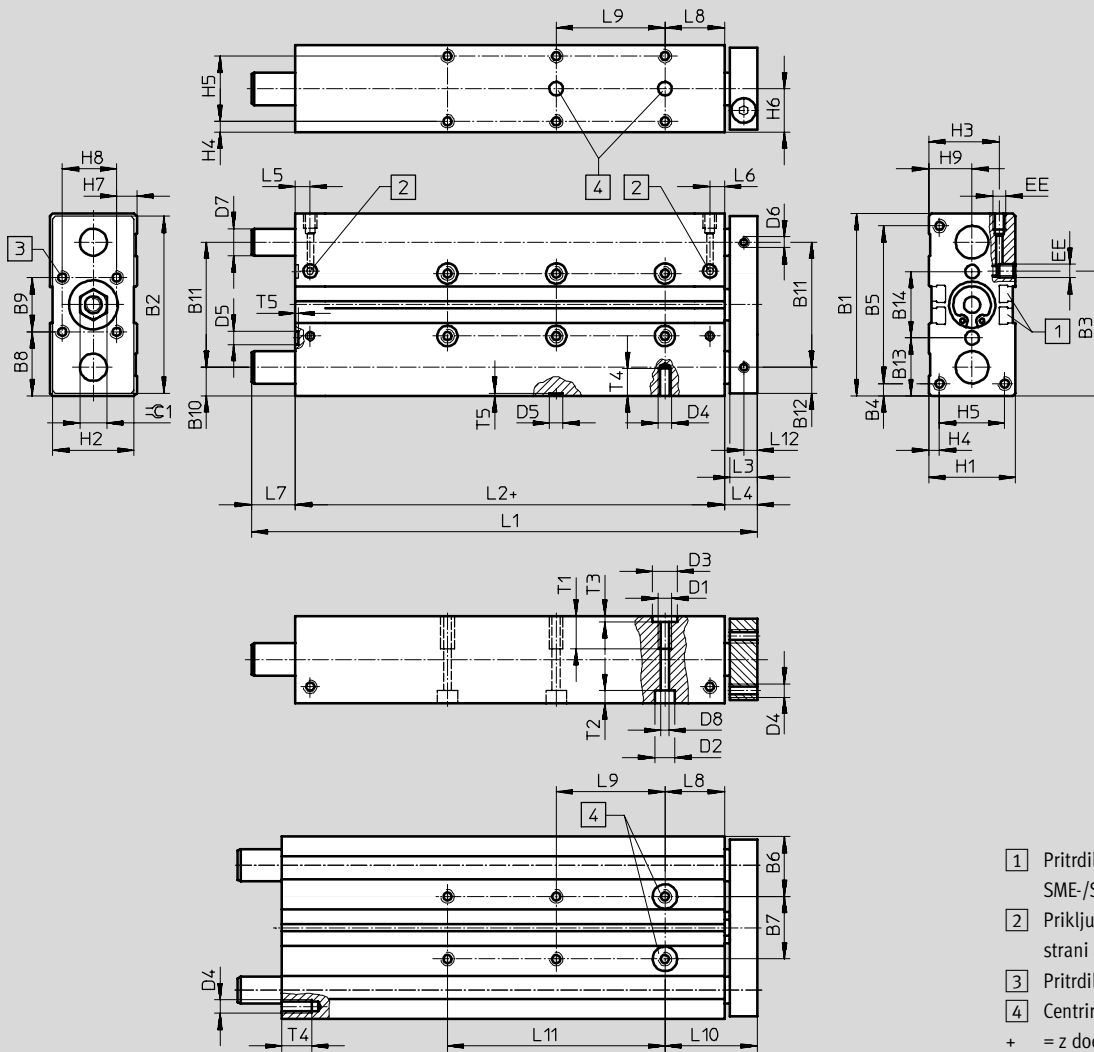

- 1 Pritrdilni utor za mejna stikala SME-/SMT-8
- 2 Priključek za zrak po želji ob strani ali zgoraj
- 3 Pritrdilni navoj
- 4 Centrirne izvrtine
- + = z dodatkom dolžine giba

Vodilne enote DFM-B

Podatkovni list

FESTO

∅	B1	B2	B3	B4	B5	B6	B7	B8	B9	B10	B11	B12	B13	B14	D1	D2
[mm]							$\pm 0,02^{1)}$							$\pm 0,02^{1)}$		∅
12	60	58	40,7	4,5	51	20,5	19	20	20	9,5	41	8,5	19,5	21	M5	8
16	67	65	45	4,5	58	22	23	23,5	20	10,5	46	9,5	21,3	24,4	M5	7,5

1) Toleranca med centriranimi izvrtinami

∅	D3	D4	D5	D6	D7		D8	EE	H1	H2	H3	H4	H5	H6	H7	H8
[mm]	∅		∅	∅	∅		∅									
	H7		H7		GF	KF	H7									
12	9	M4	5	M4	10	8	4,3	M5	28	26	24	4	20	14	4	20
16	9	M5	5	M4	12	10	4,3	M5	32	30	26,5	4	24	16	7,4	20

∅	H9	L2	L3	L4	L5	L6	L8	L10	L12	T1	T2	T3	T4	T5	$\approx \text{C}1$
[mm]															
12	14	40	10	13	14,8	11,2	21	34	5	10	9,4	2,1	8	1	10
16	16	58	10	12	9,8	9,3	22	34	5	12	4,6	2,1	10	1	10

Gib	∅ bata [mm]							
	12				16			
[mm]	L1	L7	L9	L11	L1	L7	L9	L11
			$\pm 0,02^{1)}$				$\pm 0,02^{1)}$	
10	74	11	-	-	80	-	-	-
20	84	11	-	-	90	-	-	-
25	89	11	20	-	95	-	20	-
30	94	11	20	-	100	-	20	-
40	104	11	20	-	110	-	20	-
50	114	11	40	-	120	-	40	-
80	144	11	40	-	150	-	40	-
100	164	11	40	80	170	-	40	80
125	230	52	40	80	229	34	40	80
160	265	52	40	120	264	34	40	120
200	305	52	40	160	304	34	40	160

1) Toleranca med centriranimi izvrtinami

Dimenzije

Prenos CAD-datotek → www.festo.com/de/engineering

∅ bata 12, 16 mm – fina nastavev giba izvlečene končne lege A)

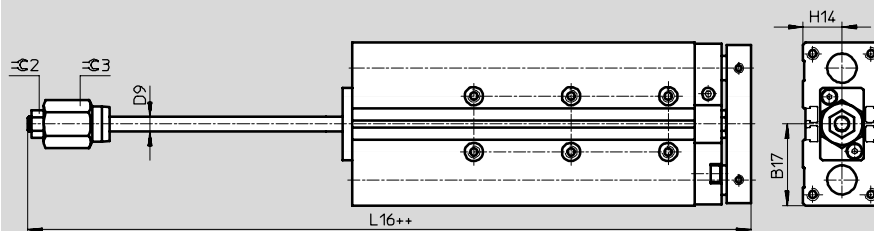

++ = z dodatkom 2x dolžine giba

∅	B17	D9	H14	L16	$\approx \text{C}2$	$\approx \text{C}3$
[mm]		∅				
12	30,5	6	14	90,6	10	17
16	33,5	6	16	107,9	10	17

Vodilne enote DFM-B

Podatkovni list



Dimenzije

Ø bata 20 ... 40 mm

Prenos CAD-datotek → www.festo.com/de/engineering

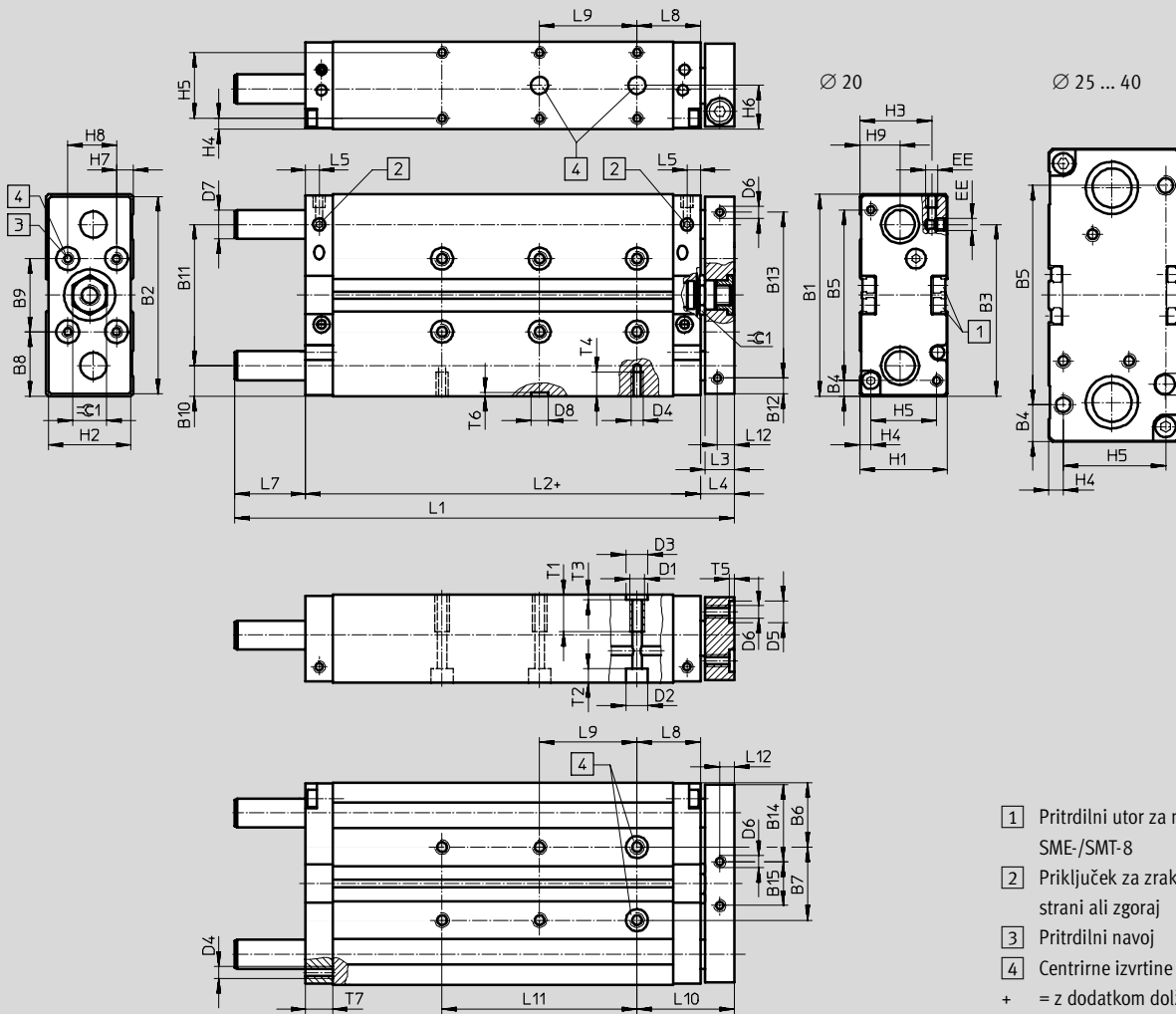

- 1 Pritrdilni utor za mejna stikala SME-/SMT-8
- 2 Priključek za zrak po želji ob strani ali zgoraj
- 3 Pritrdilni navoj
- 4 Centrirne izvrtine
- + = z dodatkom dolžine giba

- - Opozorilo

Pri vodilnih enotah DFM-20 ... 40-B segajo vodilni drogovi v zadnji končni legi izven konture ohišja. Pri tem je potrebno paziti, da se sestavni del pri montaži s čelne strani na zapirni

pokrov ne prekrije, da ne onemogoča prostega gibanja vodilnih drogov. Izjeme: DFM-40-...-B z dolžinami gibov 20, 30 in 40 mm.

Vodilne enote DFM-B

Podatkovni list

∅	B1	B2	B3	B4	B5	B6	B7	B8	B9	B10	B11	B12	B13	B14	B15	D1	D2
[mm]							±0,02 ¹⁾		±0,02 ¹⁾								∅
20	83	81	70,5	6,5	70	26,5	30	26,5	30	12,5	58	6,5	68	31,5	18	M6	9
25	95	93	67	15,5	64	30	35	27,5	40	13,5	68	13,5	68	32,5	28	M6	9
32	110	108	77	20	70	33,5	43	35	40	16	78	16	78	41	26	M8	11
40	120	118	86	15	90	34,5	51	35	50	16	88	15	88	41	36	M8	11

1) Toleranca med centrirnimi izvrtinami

∅	D3 ∅ H7	D4	D5 ∅ H7	D6 ∅	D7 ∅		D8 ∅ H7	EE	H1	H2	H3	H4	H5	H6	H7	H8
					GF	KF										
20	9	M5	9	M5	14	12	7	M5	36	34	29,5	4,5	27	18	7	20
25	9	M6	9	M6	16	14	7	G1/8	44	42	34,8	4,5	35	22	12	20
32	12	M6	9	M6	20	16	9	G1/8	49	47	39	6	37	24,5	8,5	30
40	12	M8	9	M6	20	16	9	G1/8	54	52	41,5	6	42	27	10	30

∅	H9	L2	L3	L4	L5	L8	L10	L12	T1	T2	T3	T4	T5	T6	T7	⊙ 1
[mm]																
20	16,5	62	12	14	5,5	26	40	6	15	5,7	2,1	10	2,1	1,6	11	14
25	19	70	12	14	8,5	26	40	6	15	5,7	2,1	12	2,1	1,6	15	17
32	21	75	14	16	8,5	29	45	7	20	6,8	2,6	11	2,1	2,1	15	17
40	26	76	14	16	8,5	29	45	7	20	6,8	2,6	16	2,1	2,1	15	17

Gib	∅ bata [mm]															
	20				25				32				40			
	L1	L7	L9 ±0,02 ¹⁾	L11	L1	L7	L9 ±0,02 ¹⁾	L11	L1	L7	L9 ±0,02 ¹⁾	L11	L1	L7	L9 ±0,02 ¹⁾	L11
[mm]																
20	105	9	20	-	111	7	20	-	118	7	20	-	-	-	-	-
25	110	9	20	-	116	7	20	-	123	7	20	-	123	6	20	-
30	115	9	20	-	121	7	20	-	133	12	20	-	-	-	-	-
40	135	19	20	-	141	17	20	-	143	12	20	-	-	-	-	-
50	145	19	40	-	151	17	40	-	153	12	40	-	153	11	40	-
80	185	29	40	80	196	32	40	80	208	37	40	-	208	36	40	-
100	205	29	40	80	216	32	40	80	228	37	40	80	228	36	40	80
125	257	56	40	80	271	62	40	80	283	67	40	80	283	66	40	80
160	292	56	40	120	306	62	40	120	318	67	40	120	318	66	40	120
200	332	56	40	160	346	62	40	160	358	67	40	160	358	66	40	160
250	472	146	40	200	476	142	40	200	483	142	40	200	483	141	40	200
320	592	146	40	240	546	142	40	240	553	142	40	240	553	141	40	240
400	622	146	40	320	626	142	40	320	633	142	40	320	633	141	40	320

1) Toleranca med centrirnimi izvrtinami

Vodilne enote DFM-B

Podatkovni list

FESTO

Dimenzije

Prenos CAD-datotek → www.festo.com/de/engineering

Ø bata 20 ... 40 mm – samonastavljivo dušenje YSRW

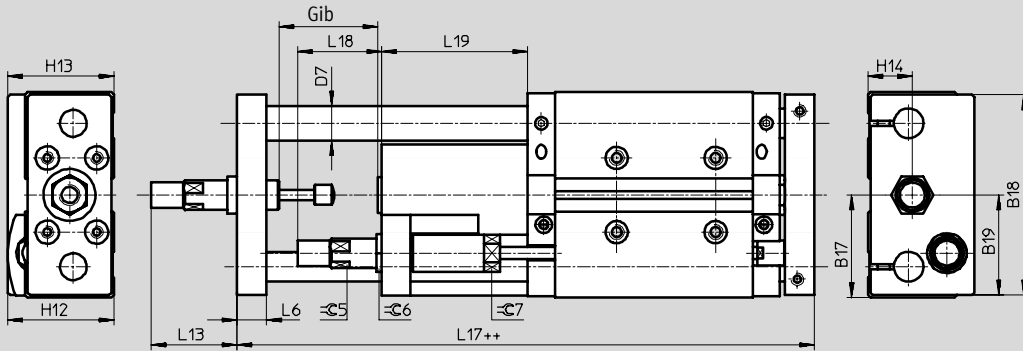

++ = z dodatkom 2x dolžine giba

Ø bata 20 ... 40 mm – fino nastavljanje giba izvlečene končne lege AJ in uvlečene končne lege EJ

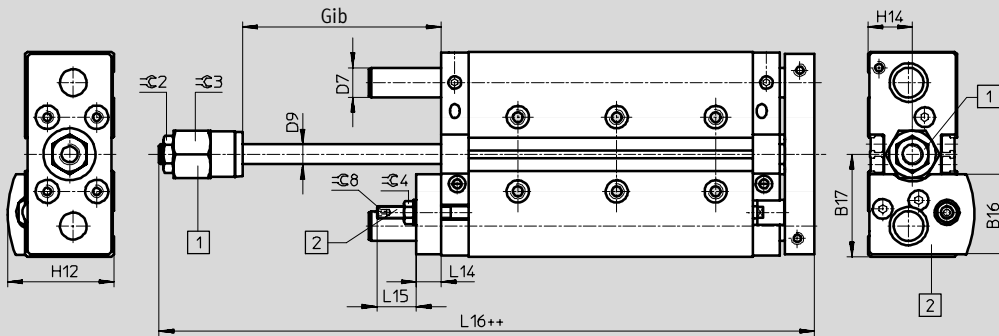

1 Varianta AJ

2 Varianta EJ

++ = z dodatkom 2x dolžine giba

Vodilne enote DFM-B

FESTO

Podatkovni list

∅ [mm]	B16	B17	B18	B19	D7 ∅		D9 ∅	H12	H13	H14	L6	L13	L14
					GF	KF							
20	32,5	41,5	81	40,5	14	12	8	43	43	18	12	36,5	10
25	38,6	47,5	90	45	16	14	10	49,5	50,5	22	14	43	12
32	43,4	55	105	52,5	20	16	12	56,5	56	24,5	16	52	12
40	46,2	60	116	58	20	16	12	62,5	63,5	27	16	72	12

∅ [mm]	L15	L16	L17	L18	L19	≈C 2	≈C 3	≈C 4	≈C 5	≈C 6	≈C 7	≈C 8
25	23,5	119,5	176,5	37,5	71	17	24	13	13	17	16	4
32	18,5	129,5	190,5	48,5	76	17	30	13	15	17	19	4
40	18,5	132	209,5	55,5	95	17	30	13	20	22	27	4

Vodilne enote DFM-B

Podatkovni list

FESTO

Dimenzije

Ø bata 50 ... 63 mm

Prenos CAD-datotek → www.festo.com/de/engineering

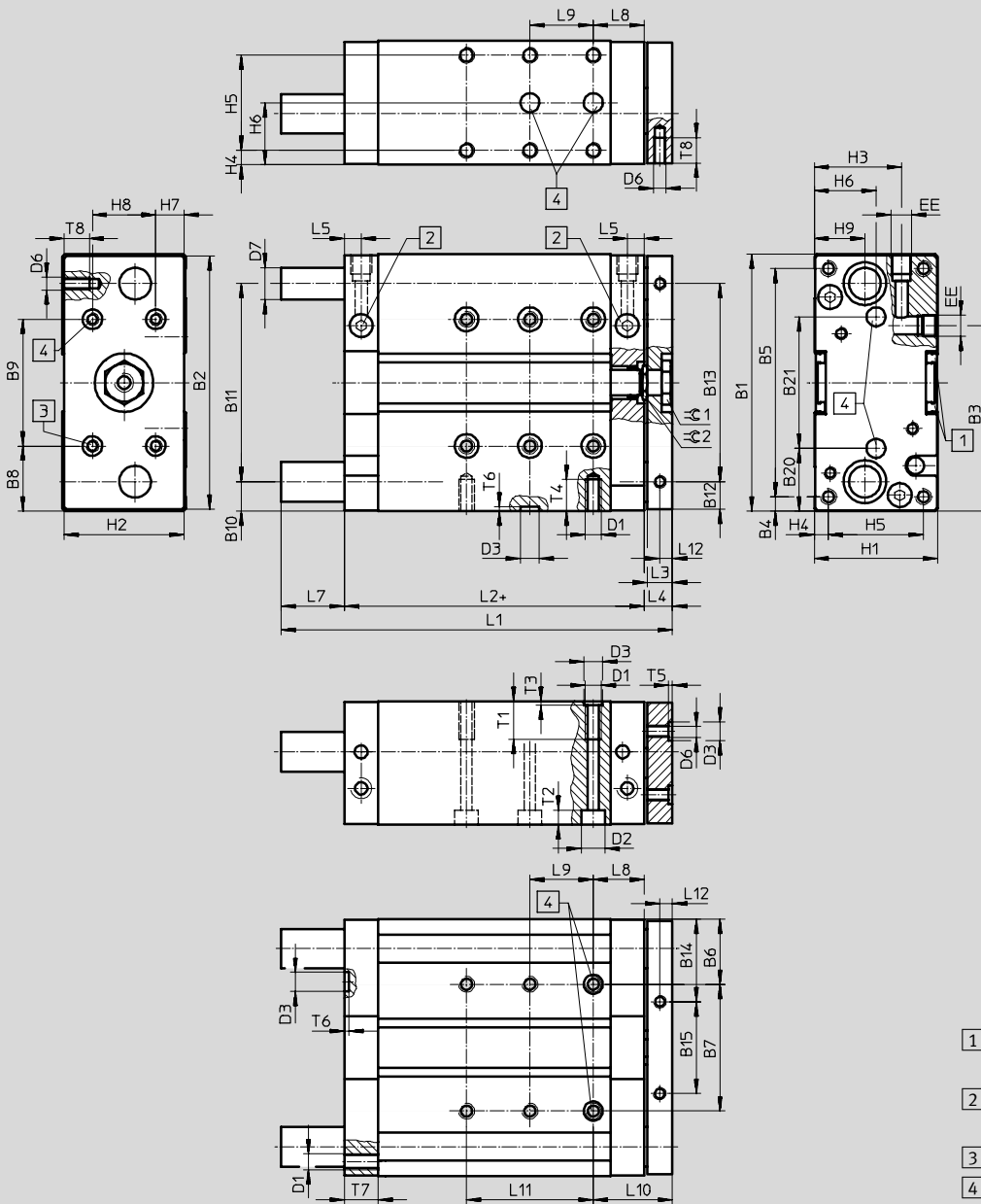

Pogoni z linearnimi vodilji
Palična vodila

6.2

Vodilne enote DFM-B

Podatkovni list

∅	B1	B2	B3	B4	B5	B6	B7	B8	B9	B10	B11	B12	B13	B14	B15	B20	B21
[mm]							±0,02 ¹⁾		±0,02 ¹⁾								±0,02 ¹⁾
50	148	146	104,5	19	110	42	64	44	60	19	110	18	110	52	42	40	68
63	162	160	117	9	144	41	80	41	80	18,5	125	17,5	125	51	58	39,5	83

∅	D1	D2	D3	D6	D7		EE	H1	H2	H3	H4	H5	H6	H7	H8
					∅	∅									
[mm]		∅	∅	∅	GF	KF									
50	M8	11	12	M8	25	20	G¼	64	62	48,5	7	50	32	12	40
63	M10	15	12	M8	25	20	G¼	78	76	55	9	60	39	19	40

∅	H9	L2	L3	L4	L5	L8	L10	L12	T1	T2	T3	T4	T5	T6	T7	T8	⊖ 1	⊖ 2
[mm]																		
50	29	88	16	18	10,5	32	50	8	20	9,8	2,6	16	2,6	2,6	21	16	24	19
63	32	89	16	18	10,5	32	50	8	24	9	2,6	20	2,6	2,6	21	16	24	19

Gib	∅ bata [mm]							
	50				63			
[mm]	L1	L7	L9	L11	L1	L7	L9	L11
25	137	6	20	-	137	5	20	-
50	177	21	40		177	20	40	
80	227	41		40	227	40		40
100	247		62		40		247	
125	293	139		40		293	138	40
160	328		40		40	328		
200	368	40		40		368	40	40
250	495		40		40	495		
320	565	40		40		565	40	40
400	645		40		40	645		

1) Toleranca med centrirnimi izvrtinami

Vodilne enote DFM-B

Podatkovni list



Dimenzije

Prenos CAD-datotek → www.festo.com/de/engineering

Ø bata 50 ... 63 mm – samonastavljivo dušenje YSRW

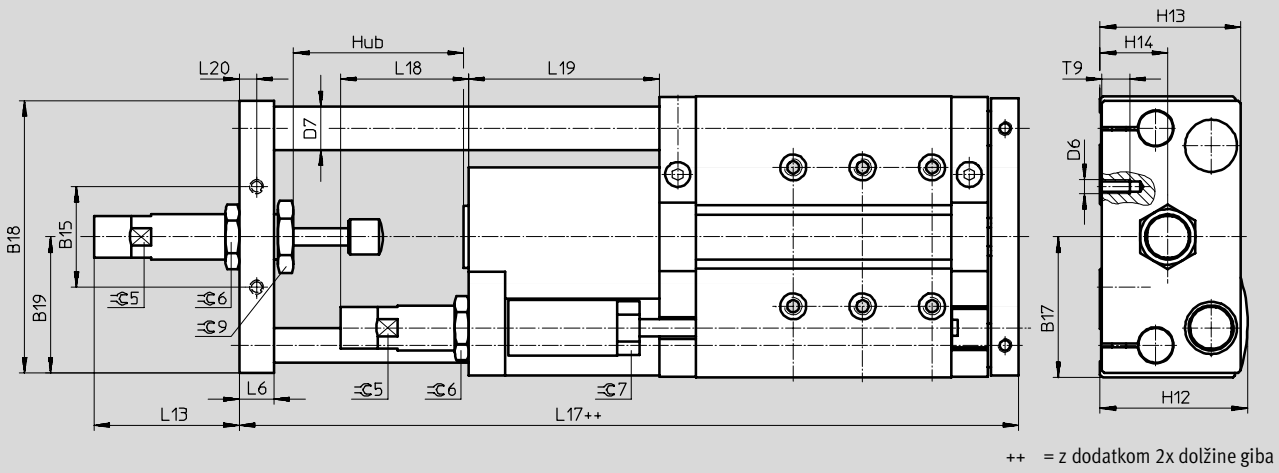

Ø bata 50 ... 63 mm – fino nastavljanje giba izvlečene končne lege AJ in vlečene končne lege EJ

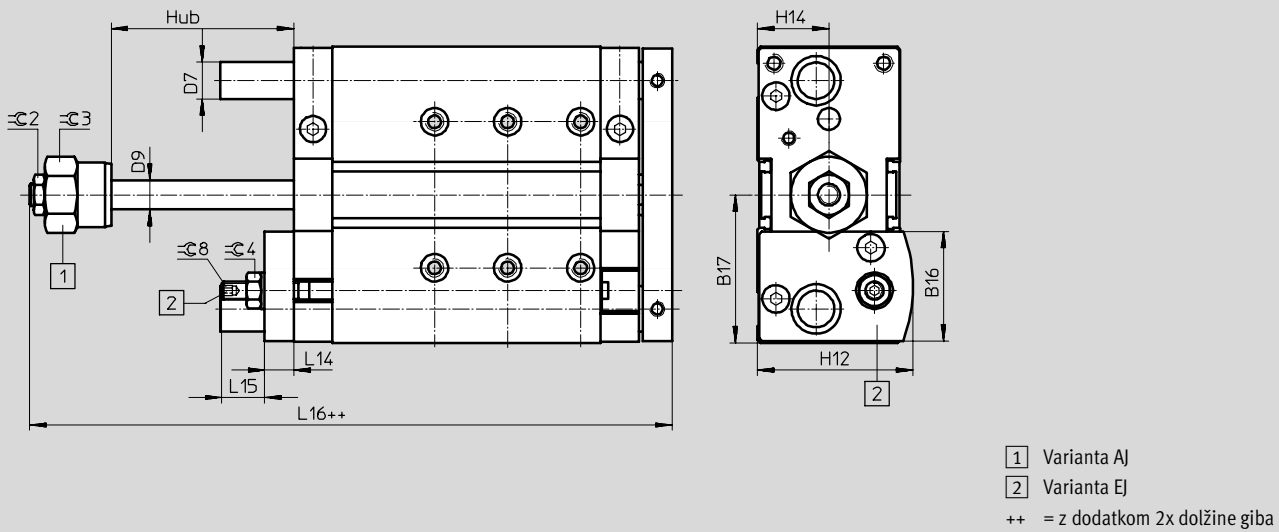

Pogoni z linearnimi vodili
Palična vodila

6.2

Vodilne enote DFM-B

Podatkovni list

FESTO

∅	B15	B16	B17	B18	B19	D6	D7		D9	H12	H13	H14	L6	L13	L14
[mm]							∅	∅							
							GF	KF							
50	42	57,6	74	157	72	M8	25	20	16	74	71	32	16	67,6	16
63	58	60	81	144	78,5	M8	25	20	16	81	81	39	20	83,3	16

∅	L15	L16	L17	L18	L19	L20	T9	≈C 2	≈C 3	≈C 4	≈C 5	≈C 6	≈C 7	≈C 8	≈C 9
[mm]															
50	24,5	152,1	226,4	58,5	93	8	16	19	36	17	20	27	22	5	30
63	23,5	151,8	249,2	74	110	10	16	19	36	17	24	32	27	5	36

Vodilne enote DFM-B, z drsnimi vodili GF

Podatki za naročanje – moduli izdelkov



Pogoni z linearnimi vodili
Palična vodila

6.2

M Minimalni podatki →

Št. modula	Vrsta	Velikost	Gib	Generacija	Dušenje	Zaznavanje položaja	Vodilo
529 119	DFM	12	10 ... 400	B	P PPV	A	GF
529 120							
532 316							
532 317							
532 318							
532 319							
534 769							
534 770							
Primer naročila							
532 319	DFM	40	400	B	P	A	GF

Tabela za naročanje

Velikost	12	16	20	25	32	40	50	63	Pogoji	Koda	Vnos kode
M Št. modula	529 119	529 120	532 316	532 317	532 318	532 319	534 769	534 770			
Vrsta	Vodilna os, modularna									DFM	DFM
Velikost	12	16	20	25	32	40	50	63		-...	
Gib [mm]	10	10	-	-	-	-	-	-		-...	
	20	20	20	20	20	-	-	-		-...	
	25	25	25	25	25	25	25	25		-...	
	30	30	30	30	30	-	-	-		-...	
	40	40	40	40	40	-	-	-		-...	
	50	50	50	50	50	50	50	50		-...	
	80	80	80	80	80	80	80	80		-...	
	100	100	100	100	100	100	100	100		-...	
	125	125	125	125	125	125	125	125		-...	
	160	160	160	160	160	160	160	160		-...	
200	200	200	200	200	200	200	200	200		-...	
-	-	250	250	250	250	250	250	250		-...	
-	-	320	320	320	320	320	320	320		-...	
-	-	400	400	400	400	400	400	400		-...	
Generacija	serija B									-B	-B
Dušenje	elastični dušilni obroči/plošče na obeh straneh									-P	
	-	pnevmatično dušenje nastavljivo na obeh straneh									-PPV
Zaznavanje položaja	za mejna stikala									-A	-A
Vodilo	Drsna vodila									-GF	-GF

¹ **PPV** Ne v kombinaciji s finim nastavljanjem AJ, EJ.

Prenos kode za naročanje

Vodilne enote DFM-B, z drsnimi vodili GF

Podatki za naročanje – moduli izdelkov

0 Opcije

Fina nastavitve v izvlečenih končnih legah	Fina nastavitve v uvlečenih končnih legah	Pribor	Pokrov utora, utora za senzorje	Mejno stikalo s kablom	Brezkontaktno mejno stikalo s kablom
AJ	EJ	ZUB	...S	...G	...I
- AJ	- EJ	ZUB	- 10S	10G	10I

Tabela za naročanje

Velikost	12	16	20	25	32	40	50	63	Pogoji	Koda	Vnos kode
0 Fina nastavitve v izvlečenih končnih legah	Fino nastavljanje, izvlečen								2	-AJ	
Fina nastavitve v uvlečenih končnih legah	-	-	Fino nastavljanje, uvlečen						2	-EJ	
Pribor	priložen v razsutem stanju									ZUB-	ZUB-
Pokrov utora, utora za senzorje	1 ... 10									...S	
Mejna stikala	s kablom 2,5 m		1 ... 10							...G	
	brezkontakten, s kablom 2,5 m		1 ... 10							...I	

2 AJ, EJ Ni z dušenjem PPV.

Prenos kode za naročanje

- - ZUB -

Vodilne enote DFM-B, s krogličnimi vodili KF

Podatki za naročanje – moduli izdelkov



Pogoni z linearnimi vodili
Palična vodila

6.2

M Minimalni podatki →

Št. modula	Vrsta	Velikost	Gib	Generacija	Dušenje	Zaznavanje položaja	Vodilo
529 119	DFM	12	10 ... 400	B	P PPV YSRW	A	KF
529 120							
532 316							
532 317							
532 318							
532 319							
534 769							
534 770							
Primer naročila							
532 319	DFM	40	400	B	P	A	KF

Tabela za naročanje

Velikost	12	16	20	25	32	40	50	63	Pogoji	Koda	Vnos kode	
M Št. modula	529 119	529 120	532 316	532 317	532 318	532 319	534 769	534 770				
Vrsta	Vodilna os, modularna									DFM	DFM	
Velikost	12	16	20	25	32	40	50	63		---		
Gib [mm]	10	10	–	–	–	–	–	–		---		
	20	20	20	20	20	–	–	–		---		
	25	25	25	25	25	25	25	25		---		
	30	30	30	30	30	–	–	–		---		
	40	40	40	40	40	–	–	–		---		
	50	50	50	50	50	50	50	50		---		
	80	80	80	80	80	80	80	80		---		
	100	100	100	100	100	100	100	100		---		
	125	125	125	125	125	125	125	125		---		
	160	160	160	160	160	160	160	160		---		
200	200	200	200	200	200	200	200		---			
–	–	250	250	250	250	250	250	250		---		
–	–	320	320	320	320	320	320	320		---		
–	–	400	400	400	400	400	400	400		---		
Generacija	serija B									-B	-B	
Dušenje	elastični dušilni obroči/plošče na obeh straneh									-P		
	–	pnevmatično dušenje nastavljivo na obeh straneh								1	-PPV	
	–	Blažilnik s progresivnim dušenjem								2	-YSRW	
Zaznavanje položaja	za mejna stikala									-A	-A	
Vodilo	Kroglična vodila									-KF	-KF	

1 PPV Ne v kombinaciji s finim nastavljanjem AJ, EJ.

2 YSRW Ne s finim nastavljanjem AJ, EJ, ker je že integrirano.

Prenos kode za naročanje

Vodilne enote DFM-B, s krogličnimi vodili KF

FESTO

Podatki za naročanje – moduli izdelkov

Opcije					
Fina nastavitve v izvlečenih končnih legah	Fina nastavitve v uvlečenih končnih legah	Pribor	Pokrov utora, utora za senzorje	Mejno stikalo s kablom	Brezkontaktno mejno stikalo s kablom
AJ	EJ	ZUB	...S	...G	...I
- AJ	- EJ	ZUB	- 10S	10G	10I

Tabela za naročanje												
Velikost	12	16	20	25	32	40	50	63	Pogoji	Koda	Vnos kode	
0 Fina nastavitve v izvlečenih končnih legah	Fino nastavljanje, izvlečen								3	-AJ		
Fina nastavitve v uvlečenih končnih legah	-	-	Fino nastavljanje, uvlečen						3	-EJ		
Pribor	priložen v razsutem stanju									ZUB-	ZUB-	
Pokrov utora, utora za senzorje	1 ... 10									...S		
Mejna stikala	s kablom 2,5 m		1 ... 10							...G		
	brezkontakten, s kablom 2,5 m		1 ... 10							...I		

3 AJ, EJ Ni z dušenjem PPV, YSRW.

Pogoni z linearnimi vodili
Palična vodila

6.2

Prenos kode za naročanje

- - ZUB -

Vodilne enote DFM/DFM-B

Pribor

FESTO

Centrima puša ZBH

Material:
Visokolegirano jeklo

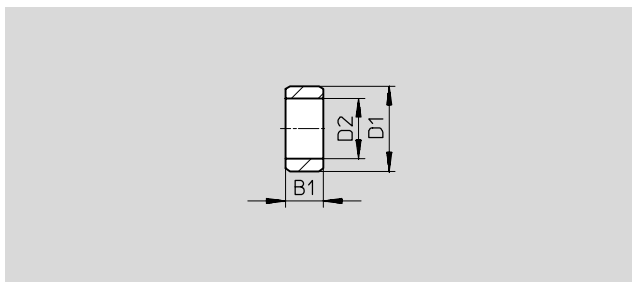

Dimenzije in podatki za naročanje (pri ponaročilu)

B1	D1	D2	KBK ¹⁾	Masa	Št. dela	Tip	PE ²⁾
-0,2	∅ h7	∅		[g]			
2,4	5	3,2	2	1	189 652	ZBH-5	10
3	7	5,3	2	1	186 717	ZBH-7	10
4	9	6,4	2	1	150 927	ZBH-9	10
5	12	10,3	2	1	189 653	ZBH-12	10
6	15	12,4	2	1	191 409	ZBH-15	10

- 1) Razred odpornosti proti koroziji 2 po Festo standardu 940 070 deli z zmerno korozijsko obremenitvijo. Vidni deli na zunanji strani s prednostno dekorativno nalogo površine, ki so v neposrednem stiku z običajno industrijsko atmosfero oz. mediji, kot so npr. mazalno-hladilna sredstva.
- 2) Pakirna enota v kosih.

Centrirne puše vključene v dobavo

DFM	∅ bata [mm]	Centrirne puše	
		za ohišje	za ploščo jarma
	12	2x ZBH-5, 2x ZBH-9	-
	16	2x ZBH-5, 2x ZBH-9	-
	20	2x ZBH-7, 2x ZBH-9	2x ZBH-9
	25	2x ZBH-7, 2x ZBH-9	2x ZBH-9
	32	2x ZBH-7, 2x ZBH-9	2x ZBH-9
	40	2x ZBH-7, 2x ZBH-9	2x ZBH-9
	50	2x ZBH-12	2x ZBH-12
	63	2x ZBH-12	2x ZBH-12
	80	2x ZBH-12	2x ZBH-12
	100	2x ZBH-15	2x ZBH-15

Centrirne puše vključene v dobavo

DFM-B	∅ bata [mm]	Centrirne puše	
		za ohišje	za ploščo jarma
	12	2x ZBH-5, 2x ZBH-9	-
	16	2x ZBH-5, 2x ZBH-9	-
	20	2x ZBH-7, 2x ZBH-9	2x ZBH-9
	25	2x ZBH-7, 2x ZBH-9	2x ZBH-9
	32	2x ZBH-7, 2x ZBH-9	2x ZBH-9
	40	2x ZBH-7, 2x ZBH-9	2x ZBH-9
	50	2x ZBH-12	2x ZBH-12
	63	2x ZBH-12	2x ZBH-12
	-	-	-
	-	-	-

Podatki za naročanje – približevalna stikala za uter 8, magnetorezistivna

Podatkovni listi → 1 / 10.2-13

	Montaža	Izhod	Električni priključek			Dolžina kabla [m]	Št. dela	Tip	
			Kabel	Vtič M8	vtič M12				
Zapirnik									
	uporaben	PNP	3-žilni	-	-	2,5	525 898	SMT-8F-PS-24V-K2,5-OE	
							525 909	SMT-8F-NS-24V-K2,5-OE	
		-	2-žilni	-	-	-	2,5	525 908	SMT-8F-ZS-24V-K2,5-OE
								525 899	SMT-8F-PS-24V-K0,3-M8D
		PNP	-	3-polni	-	-	0,3	525 910	SMT-8F-NS-24V-K0,3-M8D
								525 900	SMT-8F-PS-24V-K0,3-M12
	vložljiv, poravnani s profilom valja	PNP	3-žilni	-	-	2,5	175 436	SMT-8-PS-K-LED-24-B	
			-	3-polni	-	0,3	175 484	SMT-8-PS-S-LED-24-B	
Odpirnik									
	uporaben	PNP	3-žilni	-	-	7,5	525 911	SMT-8F-PO-24V-K7,5-OE	

Osnovni program izdelkov

Vodilne enote DFM/DFM-B

Pribor

FESTO

Podatki za naročanje – približevalna stikala za utor 8, magnetno Reed					Podatkovni listi → 1 / 10.2-19	
Montaža	Električni priključek		Dolžina kabla [m]	Št. dela	Tip	
	Kabel	Vtič M8				
Zapirnik						
	uporaben	3-žilni	-	2,5	525 895	SME-8F-DS-24V-K2,5-OE
			-	5,0	525 897	SME-8F-DS-24V-K5,0-OE
		2-žilni	-	2,5	525 907	SME-8F-ZS-24V-K2,5-OE
			-	3-polni	0,3	525 896
	vložljiv, poravnani s profilom valja	3-žilni	-	2,5	150 855	SME-8-K-LED-24
			-	3-polni	0,3	150 857
Odpirnik						
	uporaben	3-žilni	-	7,5	525 906	SME-8F-DO-24V-K7,5-OE

Podatki za naročanje – vtičnice					Podatkovni listi → 1 / 10.2-110		
Montaža	Izhod		Priključek	Dolžina kabla [m]	Št. dela	Tip	
	PNP	NPN					
Ravna vtičnica							
	Matica M8	■	■	3-polni	2,5	159 420	SIM-M8-3GD-2,5-PU
					5	159 421	SIM-M8-3GD-5-PU
	Matica M12	■	■	3-polni	2,5	159 428	SIM-M12-3GD-2,5-PU
					5	159 429	SIM-M12-3GD-5-PU
Vtičnica, zveržena							
	Matica M8	■	■	3-polni	2,5	159 422	SIM-M8-3WD-2,5-PU
					5	159 423	SIM-M8-3WD-5-PU
	Matica M12	■	■	3-polni	2,5	159 430	SIM-M12-3WD-2,5-PU
					5	159 431	SIM-M12-3WD-5-PU

Podatki za naročanje – Pokrov utora za utor 8				
Montaža	Dolžina [m]	Št. dela	Tip	
	uporaben	2x 0,5	151 680	ABP-5-S

Podatki za naročanje – povratno-dušilni ventili				Podatkovni listi → Zvezek 2	
Priključek	Material		Št. dela	Tip	
	Navoj	za zunanji Ø cevi			
	M5	3	kovinska izvedba	193 137	GRLA-M5-QS-3-D
		4		193 138	GRLA-M5-QS-4-D
		6		193 139	GRLA-M5-QS-6-D
	G1/8	3		193 142	GRLA-1/8-QS-3-D
		4		193 143	GRLA-1/8-QS-4-D
		6		193 144	GRLA-1/8-QS-6-D
		8		193 145	GRLA-1/8-QS-8-D
	G1/4	6		193 146	GRLA-1/4-QS-6-D
		8		193 147	GRLA-1/4-QS-8-D
		10		193 148	GRLA-1/4-QS-10-D
	G3/8	6		193 149	GRLA-3/8-QS-6-D
		8		193 150	GRLA-3/8-QS-8-D
		10		193 151	GRLA-3/8-QS-10-D

Osnovni program izdelkov