

Control blocks for two-hand start ZSB

FESTO



Key features

Function

The pneumatic control block for two-hand start ZSB is used where the operator is exposed to a risk of accident during manual operation, e.g. when triggering compressed air cylinders or equipment where both hands must be out of the danger zone during start-up.

The ZSB only switches when both inputs 1_1 and 1_2 of the ZSB are supplied simultaneously, i.e. within max. 0.5 seconds, by two external 3/2-way pushbutton valves. There is an output signal at connection 2.

If both pushbutton valves are activated, outlet 2 is pressurised.

If one or both pushbutton valves are released, the flow is immediately interrupted and outlet 2 is no longer pressurised. The system exhausts from 2 to 3.

The pneumatic control block for two-hand start is a safety device as defined in the EU Machinery Directive. It conforms to category 1, PL "c" in accordance with EN ISO 13849-1 and to Type III A in accordance with EN 574.

Sample circuit

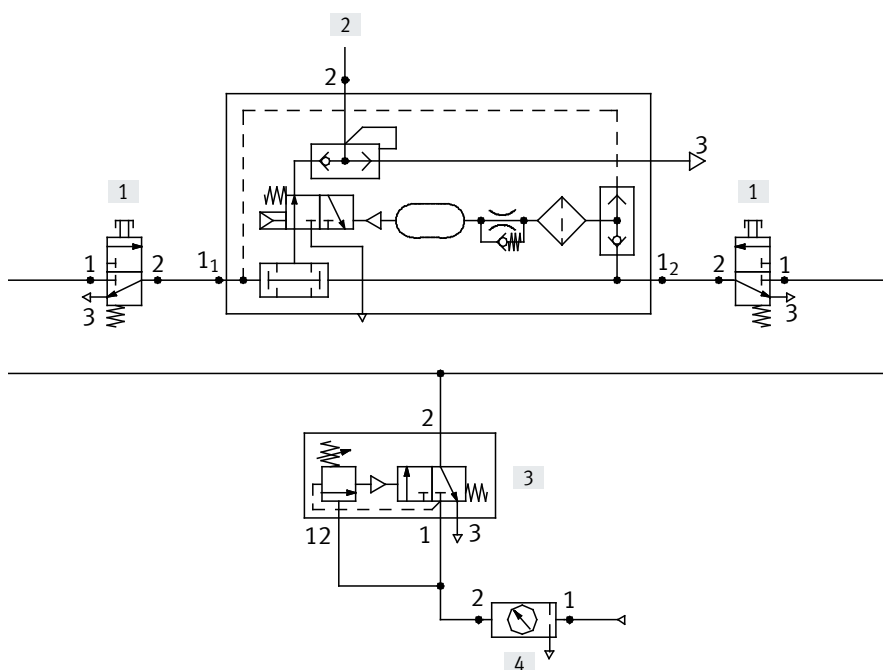

Note

When installing the two manual pushbuttons for actuating the control block for two-hand start, make sure that the protective effect cannot easily be overridden, e.g. through actuation with a hand and elbow etc. If necessary, attach an additional guard plate to the manual pushbuttons!

- [1] Front panel valve with pushbutton actuator, e.g. SV-3, T-30
- [2] Control chain
- [3] Pressure sequence valve, e.g. VD-3-PK-3
- [4] Service unit components, e.g. MS or D series

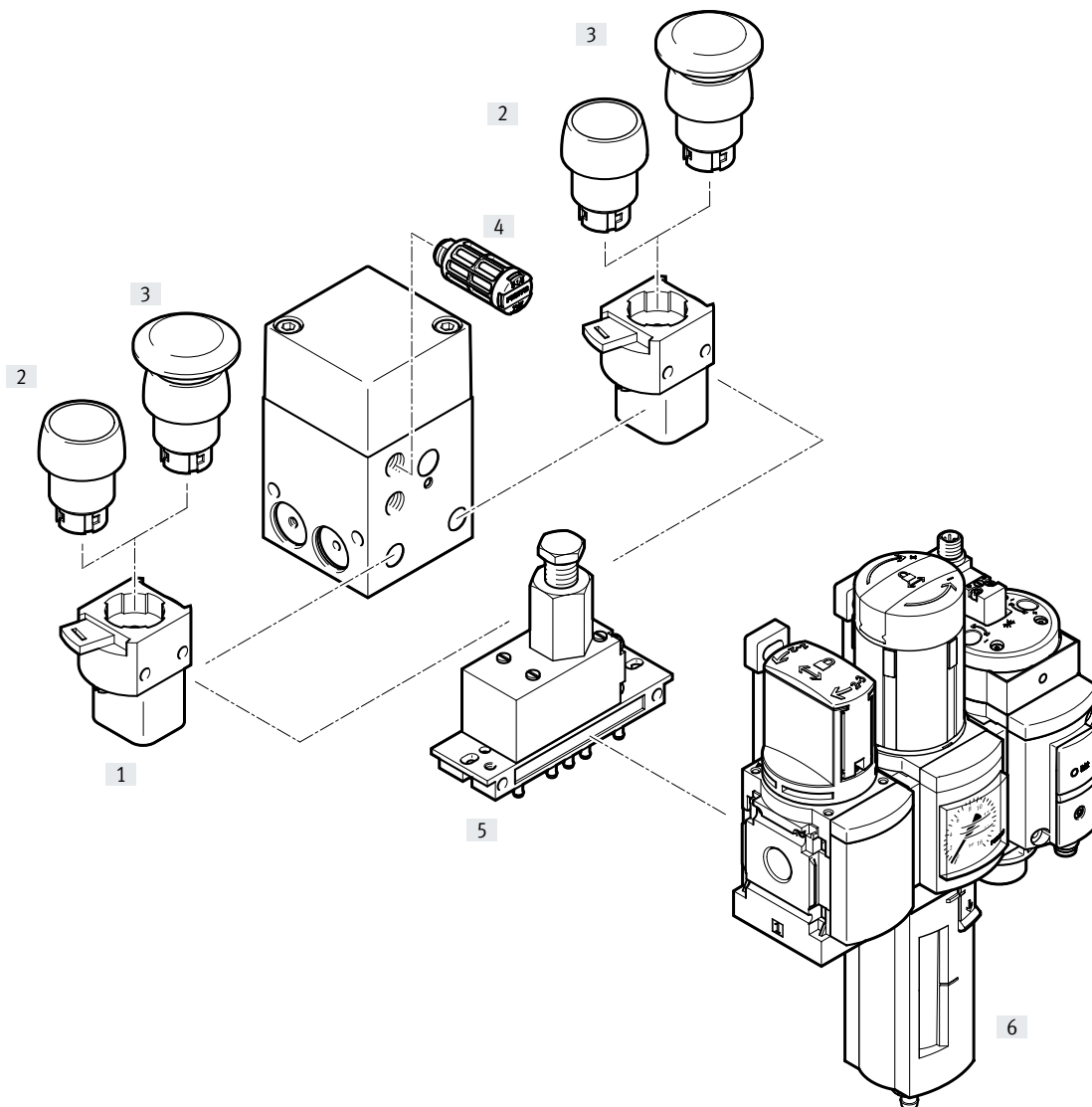

Peripherals overview

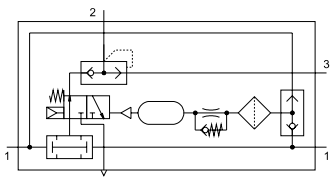

Accessories		Brief description	→ Page/Internet
[1]	Front panel valve SV	Poppet valve with quick snap-in coupling for actuator attachments	6
[2]	Pushbutton actuator T	Actuator attachment for front panel valve SV	6
[3]	Mushroom pushbutton P	Actuator attachment for front panel valve SV	6
[4]	Silencer U	For noise reduction at the exhaust port	6
[5]	Pressure sequence valve VD	For securing the minimum pressure of 4 bar required for operation	6
[6]	Service unit combination • D series • MS series	For compressed air preparation	lfr*k* msb

Datasheet



-  - Flow rate
up to 50 l/min
-  - Temperature range
0 ... +60°C
-  - Operating pressure
0.4 ... 0.8 MPa



Safety data

Safety function	Two-hand control in accordance with EN ISO 12100
Performance Level (PL)	Two-hand control: category 1, PL c in accordance with EN ISO 13849-1
Tried-and-tested component	Yes
Standard approval	Type III A according to EN574
Certificate-issuing authority	IFA 1201046
CE marking (see declaration of conformity)	To EU Machinery Directive
Shock resistance	Shock test with severity level 2 in accordance with FN 942017-5 and EN 60068-2-27

General technical data

Pneumatic connection	G1/8
Nominal width [mm]	4
Actuation type	Pneumatic
Design	Poppet valve with spring return
Type of mounting	Via through-hole Via female thread
Mounting position	Any
Standard nominal flow rate [l/min]	50
Product weight [g]	420

Operating and environmental conditions

Operating pressure	[MPa]	0.4 ... 0.8
	[bar]	4 ... 8
	[psi]	58 ... 116
Operating medium	Compressed air to ISO 8573-1:2010 [7:4:4]	
Note on the operating/pilot medium	Lubricated operation possible (in which case lubricated operation will always be required)	
Ambient temperature [°C]	0 ... +60	
Corrosion resistance class CRC ¹⁾	1	
CE marking (see declaration of conformity) ²⁾	To EU Machinery Directive	
UKCA marking (see declaration of conformity) ²⁾	To UK regulations for machines	
Certificate-issuing authority	IFA 1201046	
	Intertek UK-MCR-0080	

1) More information www.festo.com/x/topic/crc

2) More information: www.festo.com/catalogue/zsb → Support/Downloads.

Materials

Housing	Anodised wrought aluminium alloy
Cover	Die-cast aluminium
Seals	NBR
Note on materials	RoHS-compliant
LABS (PWIS) conformity	VDMA24364-B1/B2-L

Datasheet

Dimensions

Download CAD data → www.festo.com

[1] Filter

- 1₁, 1₂ = Inputs
- 2 = Output
- 3 = Exhaust

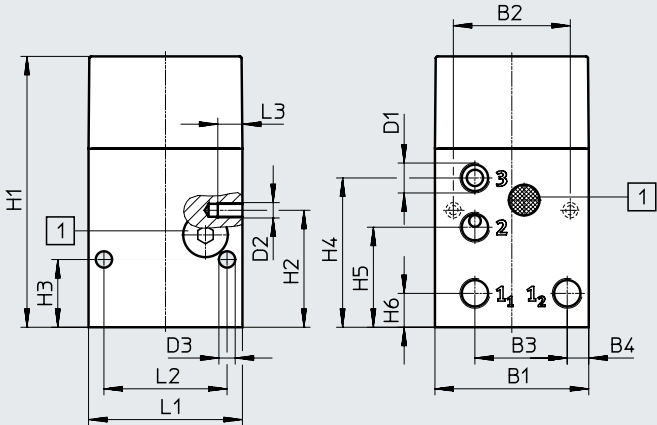

Type	B1	B2	B3	B4	D1	D2	D3 ∅	H1	H2	H3	H4	H5	H6	L1	L2	L3
ZSB	50	38	30.1	7	G1/8	M5	5.3	88	38	22	48.5	32.5	11	50	40	8

Ordering data

	Part no.	Type
Control block for two-hand start	576656	ZSB-1/8-B

Accessories

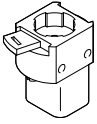
Ordering data – Front panel valve SV				Datasheets → Internet: sv	
	Pneumatic connection	Valve function	Operating pressure [bar]	Part no.	Type
	M5	3/2-way valve, closed, monostable	-0.95 ... 8	6817	SV-3-M5

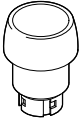
Ordering data – Pushbutton actuator T			Datasheets → Internet: t	
	Colour	Installation diameter [mm]	Part no.	Type
	Black	22.5	9289	T-22-SW
		30.5	9291	T-30-SW

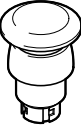
Ordering data – Mushroom pushbutton P			Datasheets → Internet: p	
	Colour	Installation diameter [mm]	Part no.	Type
	Black	22.5	9293	P-22-SW
		30.5	9295	P-30-SW

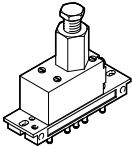
Ordering data – Pressure sequence valve VD				Datasheets → Internet: vd	
	Pneumatic connection	Valve function	Operating pressure [bar]	Part no.	Type
	PK-3	3/2-way valve, normally closed, adjustable switching pressure	1.8 ... 8	9270	VD-3-PK-3

Ordering data – Silencer U			Datasheets → Internet: u	
	Pneumatic connection	Material	Part no.	Type
	G1/8	PE	2307	U-1/8
		Die-cast aluminium	6841	U-1/8-B