

Three-dimensional gantries

FESTO

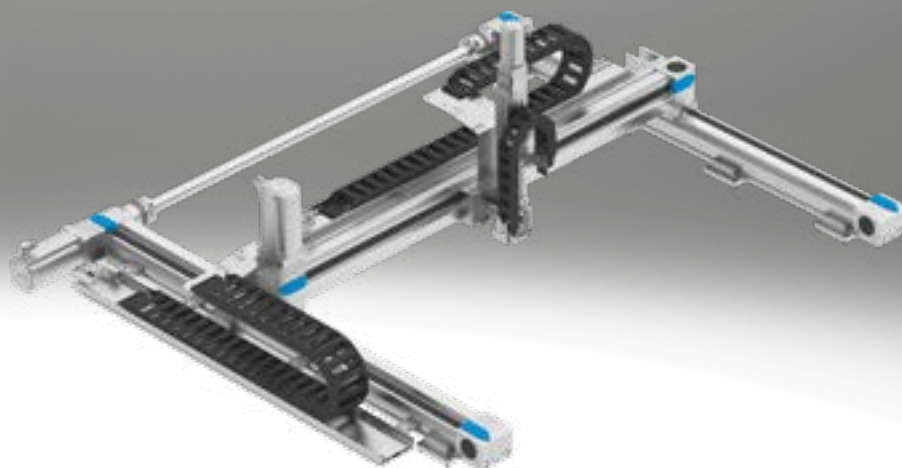

Key features

At a glance

The three-dimensional gantry facilitates movement in 3D space. Depending on the requirements, the gantry is either composed of several axis modules (YXCR) or using the planar surface gantries EXCM or EXCH (YXMR). These are all tried-and-tested components from Festo.

- Can be used generally for light to very heavy workpieces or high payloads
- Especially suitable for very long strokes
- High mechanical rigidity and sturdy design

- Pneumatic and electric components are freely combinable
- As an electrical solution it is freely positionable/any intermediate positions

Range of applications:

- For any movements in 3D space
- Very demanding requirements for precision and/or very heavy workpieces combined with long strokes (YXCR)
- Cost-effective handling unit in a compact format for small parts handling and simple tasks (YXCR-B)

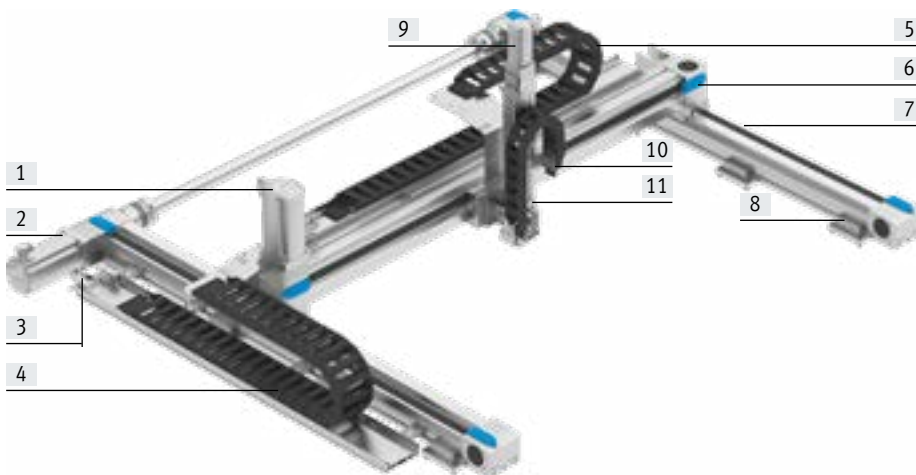

- [1] Servo motor for the Y-module
- [2] Servo motor for the X-module
- [3] Multi-pin plug distributor which transfers all electrical signals such as for end-position sensing
- [4] Energy chain for the X-module
- [5] Energy chain for the Y-module
- [6] Y-axis
- [7] X-axis
- [8] Profile mounting/adjusting kit
- [9] Servo motor for the Z-module
- [10] Energy chain for the Z-module
- [11] Z-axis

Description of the modules

X module

Design:

Depending on the configuration, the X-module comprises either two drive axes joined together by a connecting shaft (YXCR) or one drive axis + separate guide axis (YXCR-B).

They are powered by a servo or stepper motor.

Adapters are mounted on the slides of the X-axes to connect the Y-module.

The position of the motor and energy chain can be selected using the configurator.

The following components are located on the motor side:

- Energy chain (optional)
- Multi-pin plug distributor for proximity switch (if a sensor package has been selected)

Sample image:

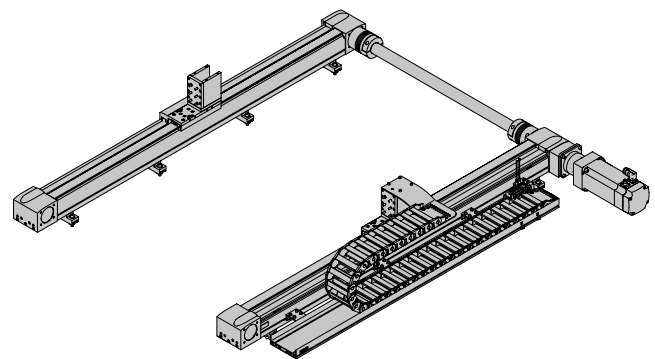

Key features

Description of the modules

Y-module

Design:

The Y-module EHYM comprises a linear axis which is powered by a servo or stepper motor.

Adapters are mounted on the slides of the Y-axis to connect the Z-module.

The position of the motor and energy chain is dependent on the position of the motor on the X-module.

The following components are located on the motor side:

- Energy chain (optional)
- Multi-pin plug distributor for proximity switch (if a sensor package has been selected)

Sample image:

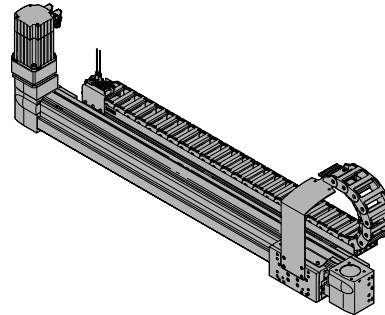

Z-module

Design:

The Z-module EHZM comprises an electric drive, the DHMZ comprises a pneumatic drive. Based on the configuration, an energy chain is optionally installed as a cable guide depending on the axis type and stroke.

The Z-module can be selected using the configurator, depending on the application.

Sample image:

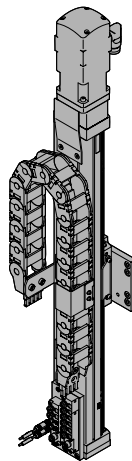

XY-module (EXCM, EXCH)

Design:

A slide is moved in a two-dimensional space (X-axis/Y-axis) via a toothed belt. The system is powered by two fixed motors. The motors are coupled to the toothed belt. The belt is guided via guide pulleys so that the slide can move to any position in a working space when the motors are actuated accordingly.

When using attachment components, additional processes can be carried out by independent Z-axes.

Sample image:

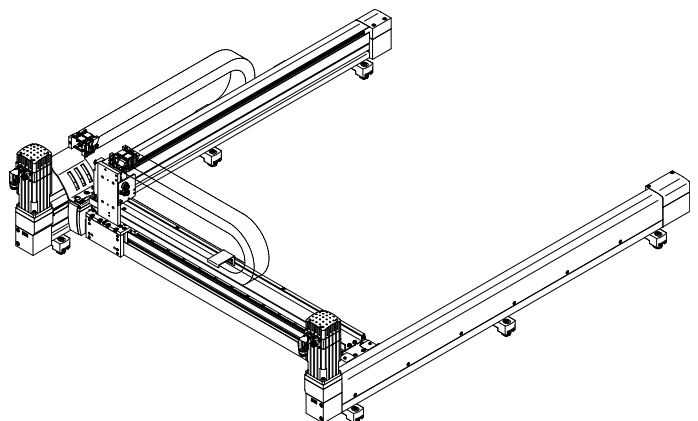

Key features

Description of the modules

Z-module (EXCM, EXCH)

Design:

The Z-module comprises either an electric drive (EHMZ) or a pneumatic drive (DHMZ).

The Z-module can be selected using the configurator, depending on the application.

Sample image:

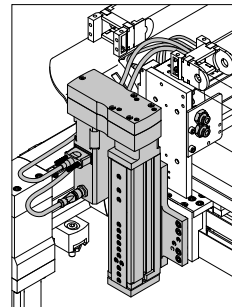
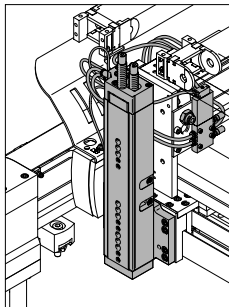

Dispatch options

Fully assembled:

The three-dimensional gantry is fully assembled. All cables and tubing are installed and connected. The system is already set up on delivery, but must be adapted to the particular mounting surface during installation.

Note flatness → table below.

Partially assembled:

The three-dimensional gantry is delivered partially assembled. This means that all three axis modules (X-/Y-/Z-axis) are assembled, each with the optional motors.

The partially assembled system must be completed by the customer. Help can be found in the assembly instructions provided.

Optional accessories (→ page 12) are enclosed.

Note flatness → table below.

System overview¹⁾

Size	YXCR-1	YXCR-2	YXCR-3	YXCR-4
Max. working stroke	X: 1900 mm Y: 1800 mm Z: 50 mm	X: 3000 mm Y: 1820 mm Z: 1000 mm	X: 3000 mm Y: 1755 mm Z: 1200 mm	X: 3000 mm Y: 1640 mm Z: 1200 mm
Max. payload	Dependent on the selected dynamic response			
Required flatness of the mounting surface	≤ 0.1 mm/m			
Mounting position	Horizontal			

Size	YXCR-1-B	YXCR-2-B
Max. working stroke	X: 800 mm Y: 600 mm Z: 150 mm	X: 1000 mm Y: 800 mm Z: 200 mm
Max. payload	Dependent on the selected dynamic response	
Required flatness of the mounting surface	≤ 0.1 mm/m	
Mounting position	Horizontal	

Size	YXMR-1	YXMR-2	YXMR-3
Max. working stroke	X: 700 mm Y: 510 mm Z: 100 mm (electric) 150 mm (pneumatic)	X: 2000 mm Y: 1000 mm Z: 200 mm (electric) 150 mm (pneumatic)	X: 2500 mm Y: 1500 mm Z: 200 mm
Max. payload	Dependent on the selected dynamic response		
Required flatness of the mounting surface	≤ 0.1 mm/m		
Mounting position	Horizontal		

1) Drive package depends on the configuration selected.

Key features

Configurator: Handling Guide Online (HGO)

Selecting a handling system

Planning complex handling systems takes a lot of time. You can use the configurator "Handling Guide Online" (HGO) to design a customised handling system for your application in just a few steps.





You can choose from the following systems:

- Single-axis system
- 2D linear gantry
- 2D planar surface gantry
- 3D gantry
- 3D cantilever system

Advantages:

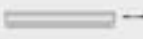
- Automatic selection of all relevant components
- Automatic design and calculation of the workload
- Quote created automatically
- CAD model available immediately
- Configuration-specific parameters for servo drives available immediately
- Complete Eplan project can be ordered according to the individual configuration
- Fully automated processing
- You can order fully or partially assembled systems through the Online Shop
- Lots of possible options

Selecting the handling solution
Select your handling system

<input type="radio"/> Single axis system		Single-axis movement Single axis module as a complete system. Easy to connect to your own front unit. [1] Attention
<input type="radio"/> 2D linear gantry		Movements in 2D in the vertical working space Linear gantries as complete systems. Electric and pneumatic axes can be combined. [1] Attention
<input type="radio"/> 2D gantry		Movements in 2D in the horizontal working space Planar surface gantries as complete systems. Combining electric axes. Easy to connect to your own Z unit. [1] Attention
<input type="radio"/> 3D gantry		Movements in 3D Three-dimensional gantries as complete systems. Electric and pneumatic axes can be combined. [1] Attention
<input type="radio"/> 3D cantilever system		Movements in 3D Cantilever system as complete system. Electric and pneumatic axes can be combined

Entering the application data

- Payload
- Drive system of the axis
- Distance from the centre of the load
- Working stroke
- Reference cycle

Axis definition and payload
Axis definition

Drive system of the axis

- X Electric: several positions
- Y Electric: several positions
- Z Electric: several positions

Required working stroke

- X mm
- Y mm
- Z mm

Working stroke in Z direction

- Z mm

Take the stroke reserve into account in your specification

Payload

Sum of the weights of the front unit and the workpiece

kg

Distance from the centre of the load

- X mm
- Y mm
- Z mm

Data protection



Key features

Configurator: Handling Guide Online (HGO)

Result of calculation

You will be offered a selection of systems that have been calculated based on the application data you entered.

The following are available immediately:

- CAD model
- Datasheet of the selected system
- Price information

Result of calculation

Select the appropriate system and continue with the configuration:

No.	System series	System workload (l)	Repetition accuracy (mm)	Your price
<input checked="" type="checkbox"/>	1 YKOR-1	91 %	0.15 mm	
<input type="checkbox"/>	3 YKOR-2	48 %	0.15 mm	
<input type="checkbox"/>	5 YKOR-2	52 %	0.15 mm	
<input type="checkbox"/>	7 YKOR-2	32 %	0.15 mm	
<input type="checkbox"/>	26 YKOR-2	48 %	0.1 mm	

Requires additional motion controller for interpolation (e.g. CPX-E-CEC-M1-...)

3D gantry YKOR 1: #1

Drive module	X module: toothed belt axis ECC-50	Y module: toothed belt axis ECC-50	Z module: Electric mini slide ECC-35
Kinematics type	Serial kinematics	Serial kinematics	Serial kinematics
Stroke	200 mm	200 mm	50 mm
Repetition accuracy (mm)	0.08 mm	0.08 mm	0.02 mm
Clear width	5.1	5.1	Without
Type of motor	Servo motor EMME-AS	Servo motor EMME-AS	Servo motor EMME-AS
Motor position	Right	Right	Top

Data protection [Back](#) [Continue](#)

System overview

You will be given an overview of the complete system.

You will also have the following options:

- Show price
- Send request
- Add to basket

Your handling solution

Your selected system overview:



©2022 powered by CADENAS
[Update CAD Preview](#)

Your system ID:
C2534118

Your next step:

[Show price](#)

[Send request](#)

[Add to Cart](#)

Key features

Standard components within the handling system

The handling system comprises a number of tried-and-tested standard components from Festo. Different components are used depending on the configuration. The single axes installed will be displayed in the configurator HGO on the "Result of calculation" page.

Drives/axes

X-Axis

Toothed belt axis EGC-TB-KF



- Electric system
- Rigid, closed profile
- Recirculating ball bearing guide for high loads and torques
- High dynamic response and minimum vibration

Spindle axis ELGC-BS



- Electric system
- Optimal installation space to working space ratio
- Protected against external influences by internal guide
- Various spindle pitches

Guide axis ELFC



- Driveless linear guide unit with guide and freely movable slide unit
- The guide axis is designed to support forces and torques in multi-axis applications

Y-axis

Toothed belt axis EGC-TB-KF



- Electric system
- Rigid, closed profile
- Recirculating ball bearing guide for high loads and torques
- High dynamic response and minimum vibration

Spindle axis ELGC-BS



- Electric system
- Optimal installation space to working space ratio
- Protected against external influences by internal guide
- Various spindle pitches

Toothed belt axis EGC-HD-TB



- Electric system
- Flat drive unit with rigid, closed profile
- Duo guide rail
- For maximum loads and torques, high feed forces and speeds and long service life

Key features

Standard components within the handling system

The handling system comprises a number of tried-and-tested standard components from Festo. Different components are used depending on the configuration. The single axes installed will be displayed in the configurator HGO on the "Result of calculation" page.

Z-axis

Mini slide EGSC



- Electric system
- Compact design
- High load capacity
- Precision guide and ball screw
- Easy adjustment of end positions

Mini slide EGSL



- Electric system
- Compact design
- High load capacity
- High dynamic response
- Easy adjustment of end positions

Mini slide DGST



- Pneumatic system
- Precise and resilient roller bearing guide
- Slide and yoke plate as a single component
- High dynamic response

Mini slide DGSL



- Pneumatic system
- Flat design
- High load capacity
- High dynamic response
- Easy adjustment of end positions

Spindle axis EGC-BS-KF



- Electric system
- Rigid, closed profile
- Recirculating ball bearing guide for high loads and torques
- High dynamic response and minimum vibration
- Various spindle pitches

Cantilever axis ELCC



- Stationary drive head
- Toothed belt drive with recirculating ball bearing guide
- High rigidity thanks to the innovative design principle
- Very low moving mass

Key features

Possible axis combinations ¹⁾			
Size	X module	Y-module	Z-module
YXCR-1	<ul style="list-style-type: none"> Toothed belt axis EGC-50-TB-KF 	<ul style="list-style-type: none"> Toothed belt axis EGC-50-TB-KF 	<ul style="list-style-type: none"> Mini slide pneumatic: DGSL-6 electric: EGSL-35
YXCR-1-B	<ul style="list-style-type: none"> Spindle axis ELGC-60-BS 	<ul style="list-style-type: none"> Spindle axis ELGC-45-BS Spindle axis ELGC-60-BS 	<ul style="list-style-type: none"> Mini slide pneumatic: DGST-8/12/16 electric: EGSC-32/45
YXCR-2	<ul style="list-style-type: none"> Toothed belt axis EGC-80-TB-KF 	<ul style="list-style-type: none"> Toothed belt axis EGC-80-TB-KF Toothed belt axis with heavy-duty guide EGC-HD-125-TB 	<ul style="list-style-type: none"> Mini slide pneumatic: DGSL-12/16 electric: EGSL-45/55 Cantilever axis ELCC-60 Spindle axis EGC-70-BS-KF
YXCR-2-B	<ul style="list-style-type: none"> Spindle axis ELGC-80-BS 	<ul style="list-style-type: none"> Spindle axis ELGC-60-BS Spindle axis ELGC-80-BS 	<ul style="list-style-type: none"> Mini slide pneumatic: DGST-12/16/20 electric: EGSC-45/60
YXCR-3	<ul style="list-style-type: none"> Toothed belt axis EGC-120-TB-KF 	<ul style="list-style-type: none"> Toothed belt axis EGC-120-TB-KF Toothed belt axis with heavy-duty guide EGC-HD-160-TB 	<ul style="list-style-type: none"> Mini slide pneumatic: DGSL-20/25 electric: EGSL-75 Cantilever axis ELCC-70 Spindle axis EGC-80-BS-KF
YXCR-4	<ul style="list-style-type: none"> Toothed belt axis EGC-185-TB-KF 	<ul style="list-style-type: none"> Toothed belt axis EGC-185-TB-KF Toothed belt axis with heavy-duty guide EGC-HD-220-TB 	<ul style="list-style-type: none"> Cantilever axis ELCC-90 Spindle axis EGC-120-BS-KF
YXMR-1	<ul style="list-style-type: none"> Planar surface gantry EXCM-30 	<ul style="list-style-type: none"> Planar surface gantry EXCM-30 	<ul style="list-style-type: none"> Mini slide pneumatic: DGSL-8/10/12 electric: EGSC-25/32
YXMR-2	<ul style="list-style-type: none"> Planar surface gantry EXCM-40, EXCH-40 	<ul style="list-style-type: none"> Planar surface gantry EXCM-40, EXCH-40 	<ul style="list-style-type: none"> Mini slide pneumatic: DGSL-16 electric: EGSL-45
YXMR-3	<ul style="list-style-type: none"> Planar surface gantry EXCH-60 	<ul style="list-style-type: none"> Planar surface gantry EXCH-60 	<ul style="list-style-type: none"> Mini slide pneumatic: DGSL-20 electric: EGSL-55

1) Drive package depends on the configuration selected.

Key features

Standard components within the handling system

The handling system comprises a number of tried-and-tested standard components from Festo. Different components are used depending on the configuration. You can alter the scope and design of the drive package in the configurator HGO on the "System configuration" page.

Motors and controllers

Servo motors EMMT-AS



- Dynamic, brushless, permanently excited servo motor
- Digital absolute displacement encoder in single-turn or multi-turn version
- With optional brake

Servo motors EMME-AS



- Dynamic, brushless, permanently excited servo motor
- Digital absolute displacement encoder in single-turn or multi-turn version
- With optional brake

Servo motors EMMB-AS



- Dynamic, brushless, permanently excited servo motor
- Digital absolute displacement encoder in single-turn or multi-turn version
- With optional brake

Stepper motors EMMS-ST



- Two-phase hybrid technology
- Step angle 1.8°
- With optional brake

Gear unit EMGA



- Low-backlash planetary gear
- Gear ratio
 $i = 3$ and 5
- Life-time lubrication

Key features

Standard components within the handling system

The handling system comprises a number of tried-and-tested standard components from Festo. Different components are used depending on the configuration. You can alter the scope and design of the drive package in the configurator HGO on the "System configuration" page.

Servo drive CMMT-AS, for servo motor



- Universal servo drive
- For synchronous servo motors
- Integrated EMC filters
- Integrated brake chopper
- Integrated braking resistor
- Position controller
- Speed controller
- Force controller
- Range of control functions

Options:

- Safety function: safe torque off (STO)/category 4, Performance Level e
- Safe stop 1 (SS1)
- Safe brake control (SBC) up to SIL3/category 3, Performance Level e

- Bus protocols
 - EtherCAT
 - PROFINET RT/IRT
 - EtherNet/IP
 - Modbus TCP

Servo drive CMMT-ST, for stepper motor



- Servo drive for operating stepper motors and brushless direct current motors
- Options for point-to-point and interpolating motion and for precise positioning
- Primary voltage from 24 ... 48 V DC
- Position controller
- Speed controller
- Force controller
- Range of control functions

Options:

- Safety function: safe torque off (STO)/category 3, Performance Level e
- Safe stop 1 time controlled (SS1-t)

- Bus protocols
 - EtherCAT
 - PROFINET RT/IRT
 - EtherNet/IP
 - Modbus TCP

Ordering data – Accessories

Module/motor combinations

We recommend that the three-dimensional gantry is operated with the proposed motors from Festo. These precisely match the mechanical system. When using third-party motors, it is essential that the technical limits are observed.

Module	Motor			
	Servo motor			Stepper motor
X module				
EHM-EGC-50-TB-KF	–	EMME-AS-40-M-LV-...	–	EMMS-ST-42-S-...
EHM-EGC-80-TB-KF	EMMT-AS-60-L-LS-... EMMT-AS-100-M-HS-...	EMME-AS-60-M-LS-...	–	EMMS-ST-57-S-...
EHM-EGC-120-TB-KF	EMMT-AS-80-L-LS-... EMMT-AS-80-L-HS-...	EMME-AS-80-S-LS-...	–	–
EHM-EGC-185-TB-KF	EMMT-AS-100-L-HS-... EMMT-AS-150-M-HS-R2...	–	–	–
EHM-ELGC-60-BS	–	–	EMMB-AS-80-07	EMMS-ST-57-M
EHM-ELGC-80-BS	–	–	EMMB-AS-80-07	EMMS-ST-87-M
Y-module				
EHM-EGC-50-TB-KF	–	EMME-AS-40-S-LV-...	–	EMMS-ST-57-M-...
EHM-EGC-80-TB-KF	EMMT-AS-60-S-LS-...	EMME-AS-60-M-LS-...	–	EMMS-ST-57-S-...
EHM-EGC-120-TB-KF	EMMT-AS-80-L-LS-... EMMT-AS-80-L-HS-...	EMME-AS-80-S-LS-...	–	EMMS-ST-87-S-...
EHM-EGC-125-TB-HD	EMMT-AS-60-L-LS-...	EMME-AS-60-M-LS-...	–	EMMS-ST-57-S-...
EHM-EGC-160-TB-HD	EMMT-AS-80-M-LS-... EMMT-AS-80-L-HS-...	EMME-AS-80-S-LS-...	–	EMMS-ST-87-S-...
EHM-EGC-185-TB-KF	EMMT-AS-100-L-HS-... EMMT-AS-100-H-HS-...	EMME-AS-100-M-HS-...	–	–
EHM-EGC-220-TB-HD	EMMT-AS-100-L-HS-... EMMT-AS-100-H-HS-...	EMME-AS-100-M-HS-...	–	–
EHM-RP-ELGC-45-BS	–	–	EMMB-AS-40-01	EMMS-ST-42-S
EHM-RP-ELGC-60-BS	–	–	EMMB-AS-60-04	EMMS-ST-57M
EHM-RP-ELGC-80-BS	–	–	EMMB-AS-60-04	EMMS-ST-87-M
Z-module				
EHM-ELCC-60-TB-KF	EMMT-AS-60-M-LS-... EMMT-AS-80-L-LS-... EMMT-AS-100-S-HS-...	–	–	–
EHM-ELCC-70-TB-KF	EMMT-AS-80-M-LS-... EMMT-AS-80-L-HS-...	–	–	–
EHM-ELCC-90-TB-KF	EMMT-AS-80-L-HS-... EMMT-AS-100-L-HS-... EMMT-AS-100-H-HS-...	–	–	–
EHM-EGC-70-BS-KF	EMMT-AS-60-S-LS-...	EMME-AS-60-M-LS-...	–	EMMS-ST-57-S-...
EHM-EGC-80-BS-KF	EMMT-AS-60-M-LS-...	EMME-AS-60-M-LS-...	–	EMMS-ST-57-S-...
EHM-EGC-120-BS-KF	EMMT-AS-80-S-LS-... EMMT-AS-80-M-LS-... EMMT-AS-80-S-HS-... EMMT-AS-80-L-HS-...	EMME-AS-80-S-LS-...	–	–
EHM-EGSL-35-BS-KF	–	EMME-AS-40-S-LV-...	–	EMMS-ST-28-L-...
EHM-EGSL-45-BS-KF	EMMT-AS-60-S-LS-...	EMME-AS-40-S-LV-...	–	EMMS-ST-57-S-...
EHM-EGSL-55-BS-KF	EMMT-AS-60-S-LS-...	EMME-AS-60-M-LS-...	–	EMMS-ST-57-S-...
EHM-EGSL-75-BS-KF	EMMT-AS-80-S-LS-...	EMME-AS-80-S-LS-...	–	EMMS-ST-87-S-...
EHM-EGSC-32	–	–	EMMB-AS-40-01	EMMS-ST-42-S
EHM-EGSC-45	–	–	EMMB-AS-40-01	EMMS-ST-42-S
EHM-EGSC-60	–	–	EMMB-AS-60-02	EMMS-ST-57M
XY-module (EXCM, EXCH)				
EXCM-30	–	–	–	EMMS-ST-42-S-...
EXCM-40	–	–	–	EMMS-ST-57-M-...
EXCH-40	EMMT-AS-80-M-LS-...	–	–	–
EXCH-40	EMMT-AS-80-L-HS-...	–	–	–
EXCH-60	EMMT-AS-100-M-HS-... EMMT-AS-150-M-HV-R3...	–	–	–

Ordering data – Accessories

Module	Motor			Stepper motor
	Servo motor			
Z-module (EXCM, EXCH)				
EHMZ-EGSC-BS-KF-25-...-V1	–	–	–	EMMS-ST-28-L-...
EHMZ-EGSC-BS-KF-32-...-V1	–	–	–	EMMS-ST-42-S-...
EHMZ-EGSL-45-BS-KF-...-V1	EMMT-AS-60-S-LS-...	–	–	–
EHMZ-EGSL-55-BS-KF-...-V1	EMMT-AS-60-S-LS-...	–	–	–

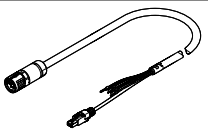
Ordering data	Description	Cable length [m]	Part no.	Type
For servo motor EMMT-AS				
Motor cable				
	• For EMMT-AS-60/80-...-R2... with CMMT-AS	2.5	5251374	NEBM-M23G15-EH-2.5-Q7N-R3LEG14
		5	5251375	NEBM-M23G15-EH-5-Q7N-R3LEG14
		7.5	5251376	NEBM-M23G15-EH-7.5-Q7N-R3LEG14
		10	5251377	NEBM-M23G15-EH-10-Q7N-R3LEG14
		15	5251378	NEBM-M23G15-EH-15-Q7N-R3LEG14
	• For EMMT-AS-100-...-R2... with CMMT-AS • For EMMT-AS-150-...-R2... with CMMT-AS	2.5	5251381	NEBM-M23G15-EH-2.5-Q9N-R3LEG14
		5	5251382	NEBM-M23G15-EH-5-Q9N-R3LEG14
		7.5	5251383	NEBM-M23G15-EH-7.5-Q9N-R3LEG14
		10	5251384	NEBM-M23G15-EH-10-Q9N-R3LEG14
		15	5251385	NEBM-M23G15-EH-15-Q9N-R3LEG14
	• For EMMT-AS-150-...-R3... with CMMT-AS	2.5	5251395	NEBM-M40G15-EH-2.5-Q11N-R3LEG14
		5	5251396	NEBM-M40G15-EH-5-Q11N-R3LEG14
		7.5	5251397	NEBM-M40G15-EH-7.5-Q11N-R3LEG14
		10	5251398	NEBM-M40G15-EH-10-Q11N-R3LEG14
		15	5251399	NEBM-M40G15-EH-15-Q11N-R3LEG14
20	5251400	NEBM-M40G15-EH-20-Q11N-R3LEG14		

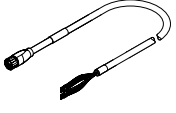
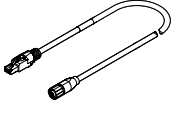

Ordering data	Description	Cable length [m]	Part no.	Type
For servo motor EMME-AS				
Motor cable				
	• For EMME-AS-40/60 with CMMT-AS	2.5	5391541	NEBM-M16G8-E-2.5-Q7-LE8-1
		5	5391543	NEBM-M16G8-E-5-Q7-LE8-1
		7.5	5391548	NEBM-M16G8-E-7.5-Q7-LE8-1
		10	8085952	NEBM-M16G8-E-10-Q7-LE8-1
		15	8085953	NEBM-M16G8-E-15-Q7-LE8-1
	• For EMME-AS-80/100 with CMMT-AS	2.5	611113	NEBM-M16G8-E-20-Q7-LE8-1
		2.5	5391540	NEBM-M16G8-E-2.5-Q9-LE8-1
		5	5391545	NEBM-M16G8-E-5-Q9-LE8-1
		7.5	5391547	NEBM-M16G8-E-7.5-Q9-LE8-1
		10	5391549	NEBM-M16G8-E-10-Q9-LE8-1
		15	5391550	NEBM-M16G8-E-15-Q9-LE8-1
20	611114	NEBM-M16G8-E-20-Q9-LE8-1		
Encoder cable				
	• For EMME-AS-40/60/80/100 with CMMT-AS	2.5	5212312	NEBM-M12G8-E-2.5-N-R3G8
		5	5212313	NEBM-M12G8-E-5-N-R3G8
		7.5	5212314	NEBM-M12G8-E-7.5-N-R3G8
		10	5212315	NEBM-M12G8-E-10-N-R3G8
		15	5212316	NEBM-M12G8-E-15-N-R3G8
		20	611112	NEBM-M12G8-E-20-N-R3G8

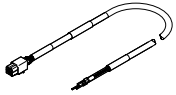
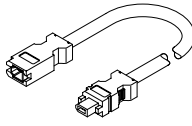
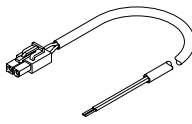
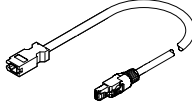
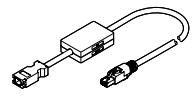
Ordering data – Accessories

Ordering data		Cable length [m]	Part no.	Type
For servo motor EMMB-AS				
Motor cable				
 <ul style="list-style-type: none"> For EMMB-AS-40/60/80 with CMMT-AS 	2.5	5219197	NEBM-H6G4-E-2.5-Q13N-LE4	
	5	5219198	NEBM-H6G4-E-5-Q13N-LE4	
	7.5	5219199	NEBM-H6G4-E-7.5-Q13N-LE4	
	10	5219200	NEBM-H6G4-E-10-Q13N-LE4	
	15	8097203	NEBM-H6G4-E-15-Q13N-LE4	
Encoder cable				
 <ul style="list-style-type: none"> For EMMB-AS-40/60/80 with CMMT-AS 	2.5	5219213	NEBM-REG6-E-2.5-Q14N-REG6	
	5	5219214	NEBM-REG6-E-5-Q14N-REG6	
	7.5	5219215	NEBM-REG6-E-7.5-Q14N-REG6	
	10	5219216	NEBM-REG6-E-10-Q14N-REG6	
	15	8097200	NEBM-REG6-E-15-Q14N-REG6	
Connecting cable for brake				
 <ul style="list-style-type: none"> For EMMB-AS-40/60/80 with CMMT-AS 	2.5	5219205	NEBM-H7G2-E-2.5-Q14N-LE2	
	5	5219206	NEBM-H7G2-E-5-Q14N-LE2	
	7.5	5219207	NEBM-H7G2-E-7.5-Q14N-LE2	
	10	5219208	NEBM-H7G2-E-10-Q14N-LE2	
	15	8097206	NEBM-H7G2-E-15-Q14N-LE2	
Adapter for encoder cable (absolutely essential)				
 <ul style="list-style-type: none"> For EMMB-AS-40/60/80 with CMMT-AS 	For single-turn version with CMMT-AS			
	0.5	8097197	NEFM-REG6-K-0.5-R3G8	
 <ul style="list-style-type: none"> For EMMB-AS-40/60/80 with CMMT-AS 	For multi-turn version with CMMT-AS¹⁾			
	0.5	8097195	NEFM-REG6-K-0.5-B-R3G8	
	For multi-turn version with CMMB-AS¹⁾			
0.5	8097196	NEFM-REG6-K-0.5-B-REG6		

1) The required battery is not included in the scope of delivery

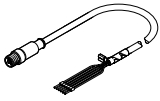
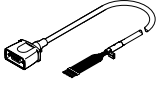
Ordering data – Accessories

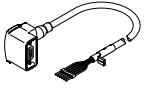
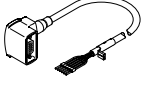
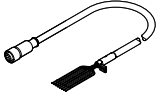
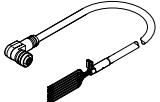
Designation	Description	Cable length [m]	Part no.	Type
For stepper motor EMMS-ST				
Motor cable¹⁾				
	• For stepper motor EMMS-ST-28-...-G2 with CMMT-ST	1.5	1449600	NEBM-SM12G8-E-1.5-Q5-LE6
		2.5	1449601	NEBM-SM12G8-E-2.5-Q5-LE6
		5	1449602	NEBM-SM12G8-E-5-Q5-LE6
		7	1449603	NEBM-SM12G8-E-7-Q5-LE6
		10	1449604	NEBM-SM12G8-E-10-Q5-LE6
		15	5105618	NEBM-SM12G8-E-15-Q5-LE6
	• For stepper motor EMMS-ST-42/57-...-G2 with CMMT-ST • Straight plug	2.5	1450369	NEBM-S1G9-E-2.5-Q5-LE6
		5	1450370	NEBM-S1G9-E-5-Q5-LE6
		7	1450371	NEBM-S1G9-E-7-Q5-LE6
		10	1450372	NEBM-S1G9-E-10-Q5-LE6
		15	5085055	NEBM-S1G9-E-15-Q5-LE6
		20	5085056	NEBM-S1G9-E-20-Q5-LE6
	• For stepper motor EMMS-ST-42-...-SE-G3 with CMMT-ST • Straight plug • Motor for mechanism EXCM-30	2.5	550326	NEBU-M12G5-K-2.5-LE4
		5	541328	NEBU-M12G5-K-5-LE4
	• For stepper motor EMMS-ST-42/57-...-G2 with CMMT-ST • Angled plug	2.5	1450737	NEBM-S1W9-E-2.5-Q5-LE6
		5	1450738	NEBM-S1W9-E-5-Q5-LE6
		7	1450739	NEBM-S1W9-E-7-Q5-LE6
		10	1450740	NEBM-S1W9-E-10-Q5-LE6
		15	610856	NEBM-S1W9-E-15-Q5-LE6
	• For stepper motor EMMS-ST-87-...-G2 with CMMT-ST • Angled plug	2.5	1450944	NEBM-S1W15-E-2.5-Q7-LE6
		5.0	1450945	NEBM-S1W15-E-5-Q7-LE6
		7.0	1450946	NEBM-S1W15-E-7-Q7-LE6
		10	1450947	NEBM-S1W15-E-10-Q7-LE6
		15	610857	NEBM-S1W15-E-15-Q7-LE6
Encoder cable¹⁾				
	• For stepper motor EMMS-ST-28/42/57/87-...-G2/G3 with CMMT-ST • Straight plug	2.5	1451587	NEBM-M12G8-E-2.5-LE8
		5	1451588	NEBM-M12G8-E-5-LE8
		7	1451589	NEBM-M12G8-E-7-LE8
		10	1451590	NEBM-M12G8-E-10-LE8
		15	611110	NEBM-M12G8-E-15-LE8
		20	611111	NEBM-M12G8-E-20-LE8
	• For stepper motor EMMS-ST-28/42/57/87-...-G2 with CMMT-ST • Angled plug	2.5	1451675	NEBM-M12W8-E-2.5-LE8
		5	1451676	NEBM-M12W8-E-5-LE8
		7	1451677	NEBM-M12W8-E-7-LE8
		10	1451678	NEBM-M12W8-E-10-LE8
		15	610858	NEBM-M12W8-E-15-LE8

1) Cables especially suitable for the motor controller and motor.
Degree of protection to IP65 (in assembled state)

Possible cable and tube lengths



- Cables and tubing are selected so that the length specified when ordering will be the minimum connection length from the energy chain output.
- Cables and tubing are only available in fixed lengths as stated in the table below. This can mean that the cable plugs of the different cables do not end at the same point.

Length	1 m	2 m	5 m	7 m	10 m
Motor cable	–	■	■	■	■
Encoder cable	–	■	■	■	■
Multi-pin plug connecting cable	–	■	■	■	■
Tubing (for DHMZ only)	■	■	■	–	–

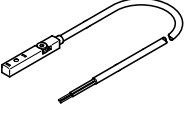

Ordering data – Accessories

Standard components within the handling system

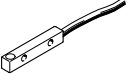
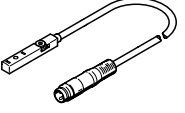
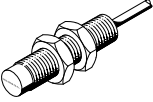

The handling system comprises a number of tried-and-tested standard components from Festo. Different components are used depending on the configuration. You can alter the scope and design of the accessories in the configurator HGO on the "System configuration" page.

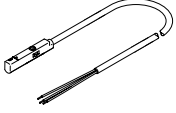
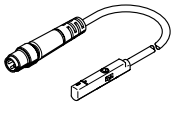
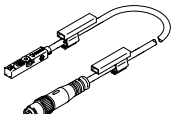
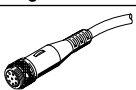
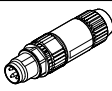
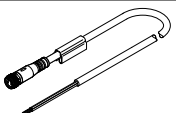
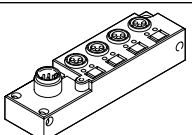
Designation	Description	Cable length [m]	Part no.	Type	
Proximity switch (inductive) for sensing the position of the slide on the X-/Y-/Z-axis					
	Cable with open end				
	<ul style="list-style-type: none"> For toothed belt axis EGC-TB, EGC-HD-TB For spindle axis EGC-BS For spindle axis ELGC-BS For mini slide EGSL For mini slide EGSC For DC voltage Included if the "Festo sensor package" is selected: <ul style="list-style-type: none"> For EGC, ELGC: 2 pieces For EGSL, EGSC: 1 piece 	PNP, N/C contact	7.5	551391	SIES-8M-PO-24V-K-7.5-OE
		PNP, N/O contact	7.5	551386	SIES-8M-PS-24V-K-7.5-OE
		NPN, N/C contact	7.5	551401	SIES-8M-NO-24V-K-7.5-OE
		NPN, N/O contact	7.5	551396	SIES-8M-NS-24V-K-7.5-OE
Proximity switches for sensing the position of the slide on the X-axis					
	<ul style="list-style-type: none"> For EXCM-40, EXCH-40, EXCH-60 	PNP, N/O contact	–	150491	SIES-V3B-PS-S-L
	<ul style="list-style-type: none"> For EXCM-40, EXCH-40, EXCH-60 Included if the "Festo sensor package" is selected: <ul style="list-style-type: none"> 1 piece 	PNP, N/C contact	–	174552	SIES-Q8B-PO-K-L
Proximity switch (inductive) for sensing the position of the slide on the Y-axis					
	Cable with plug				
	<ul style="list-style-type: none"> For EXCM-40, EXCH-40, EXCH-60 For DC voltage Included if the "Festo sensor package" is selected: <ul style="list-style-type: none"> 1 piece 	PNP, N/C contact	0.3	551392	SIES-8M-PO-24V-K-0.3-M8D
PNP, N/O contact		0.3	551387	SIES-8M-PS-24V-K-0.3-M8D	
Proximity switch (inductive) for sensing the position of the slide on the Z-axis					
	Cable with open end				
	<ul style="list-style-type: none"> For cantilever axis ELCC For DC voltage Included if the "Festo sensor package" is selected: <ul style="list-style-type: none"> 2 pieces 	PNP, N/C contact	2.5	150398	SIEN-M8NB-PO-K-L
		PNP, N/O contact	2.5	150394	SIEN-M8NB-PS-K-L
		NPN, N/C contact	2.5	150396	SIEN-M8NB-NO-K-L
NPN, N/O contact		2.5	150392	SIEN-M8NB-NS-K-L	

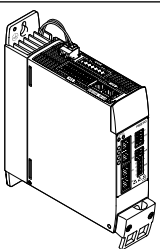
Ordering data – Accessories

Designation	Description	Cable length [m]	Part no.	Type	
Proximity switches (magneto-resistive) for sensing the position of the slide on the Z-axis					
	Cable with open end <ul style="list-style-type: none"> For mini slide DGSL For DC voltage Included if the "Festo sensor package" is selected: <ul style="list-style-type: none"> 2 pieces 	PNP, N/O contact	2.5	551373	SMT-10M-PS-24V-E-2.5-L-OE
		NPN, N/O contact	2.5	551377	SMT-10M-NS-24V-E-2.5-L-OE
	<ul style="list-style-type: none"> For mini slide DGST-8/-12 For DC voltage Included if the "Festo sensor package" is selected: <ul style="list-style-type: none"> 2 pieces 	PNP, N/O contact	2.5	551375	SMT-10M-PS-24V-E-0.3-L-M8D
		NPN, N/O contact	2.5	551379	SMT-10M-NS-24V-E-0.3-L-M8D
	<ul style="list-style-type: none"> For mini slide DGST-16/-20 For DC voltage Included if the "Festo sensor package" is selected: <ul style="list-style-type: none"> 2 pieces 	PNP, N/O contact	2.5	574334	SMT-8M-A-PS-24V-E-0.3-M8D
		NPN, N/O contact	2.5	574339	SMT-8M-A-NS-24V-E-0.3-M8D
Plug socket with cable					
	<ul style="list-style-type: none"> Connection between multi-pin plug distributor NEDU and control cabinet 	5	525618	SIM-M12-8GD-5-PU	
		10	570008	SIM-M12-8GD-10-PU	
Plug					
	<ul style="list-style-type: none"> For connection to the multi-pin plug distributor NEDU / distributor NEDY 	–	562024	NECU-S-M8G3-HX	
Connecting cable					
	<ul style="list-style-type: none"> Connection between distributor NEDY and control cabinet 	2.5	541342	NEBU-M8G4-K-2.5-LE4	
		5	541343	NEBU-M8G4-K-5-LE4	
		7.5	610854	NEBU-M8G4-K-7.5-LE4	
		10	589560	NEBU-M8G4-K-10-LE4	
		15	610855	NEBU-M8G4-K-15-LE4	
Multi-pin plug distributor					
	<ul style="list-style-type: none"> With the help of the multi-pin plug distributor, all electrical signals such as for end-position sensing can be transferred Options: <ul style="list-style-type: none"> 4 individual connections 6 individual connections 	–	574586	NEDU-L4R1-M8G3L-M12G8	
		–	574587	NEDU-L6R1-M8G3L-M12G8	
	<ul style="list-style-type: none"> With the help of the distributor, all electrical signals such as for end-position sensing can be transferred 2 individual connections 	–	8005312	NEDY-L2R1-V1-M8G3-N-M8G4	
Motor controller/servo drive					
	The accessories for the relevant motor controllers/servo drives can be found at: <ul style="list-style-type: none"> www.festo.com/catalogue/cmmt 				

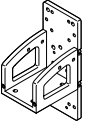
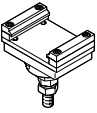
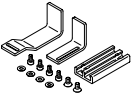
Ordering data – Accessories

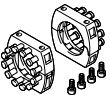
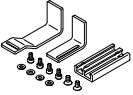
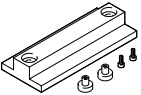
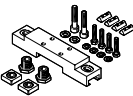
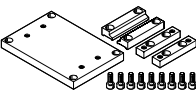
Designation	Description	Part no.	Type
Mounting kit			
	<ul style="list-style-type: none"> Mounting kit for the energy chain and a Z-axis, such as EGSL, DGSL 	EXCM-30 4070088	EAHT-E9-FB-3D-30
Adjusting kit			
	<ul style="list-style-type: none"> Height-adjustable mounting kit 	EXCM-30 4070088	EADC-E11-30
Sensor mounting			
	<ul style="list-style-type: none"> For homing in combination with third-party motors 	EXCM-30 4070088	EAPR-E11-30
Energy chain			
	<ul style="list-style-type: none"> As a cable guide for the Z-axis 	EXCM-30 8059999 8060324	EADH-U-3D-30 EADH-U-3D-40
Connection kit			
	<ul style="list-style-type: none"> Retaining brackets for mounting the energy chain 	EXCM-30 8060325 8060326	EAHT-AE-3D-30 EAHT-AE-3D-40
Sensor mounting			
	<ul style="list-style-type: none"> For mounting the proximity switches SIES-Q8B, SIES-V3B on the X-axis 	EXCM-40, EXCH-40 EXCH-60 2536353 2478805	EAPR-E12-40 EAPR-E12-60
Adjusting tool			
	<ul style="list-style-type: none"> For aligning and checking the flatness of the planar surface gantry 	EXCM-40, EXCH-40, EXCH-60 3197697	EADT-W-E12
Adjusting kit			
	<ul style="list-style-type: none"> Used to mount the handling system on the supporting surface Can be used to easily compensate for any unevenness in the bearing surface 	EHMX-...-EGC-50-TB-KF EHMX-...-EGC-80-TB-KF EHMX-...-EGC-120-TB-KF EHMX-...-EGC-185-TB-KF EHMX-...-ELGC-60-BS EHMX-...-ELGC-80-BS 8047565 8047566 8047567 8047568 8142650 8142651	EADC-E15-50-E7 EADC-E15-80-E7 EADC-E15-120-E7 EADC-E15-185-E7 EADC-E15-60-E22 EADC-E15-80-E22
Profile mounting			
	<ul style="list-style-type: none"> Used to mount the handling system on the supporting surface It is not height-adjustable 	EHMX-...-ELGC-60-BS EHMX-...-ELGC-80-BS 8142652 8142653	EAHM-E15-60-E22 EAHM-E15-80-E22

Programming aid

Festo Automation Suite

Parameterisation and programming software for electronic devices from Festo

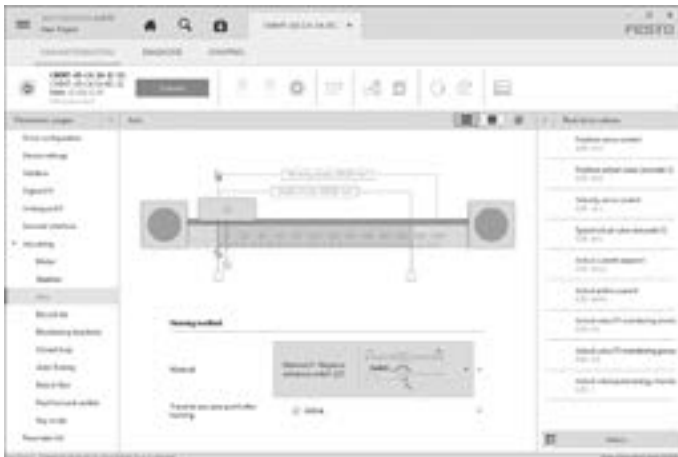

- Parameterisation, programming and commissioning in a clear and user-friendly interface
- Optimum support for complex processes thanks to guided wizards (e.g. for commissioning, drive configuration, etc.)
- Fast access to the required documents and additional information
- Easy integration of electric drives in the controller programming