

# Pneumatic valves VUWS/valve manifold assembly VTUS

**FESTO**

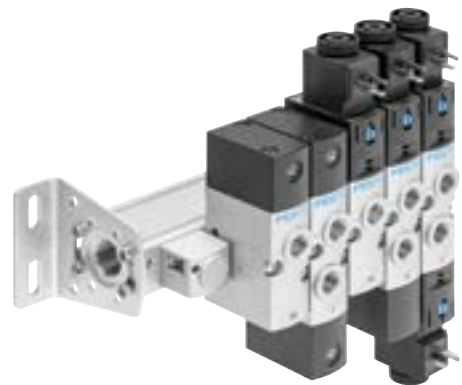

## Key features



### Innovative

- A reliable, robust valve with a long service life
- Design principle:
  - Poppet seat, soft-sealing (VUWS-LT)
  - Piston spool with sealing cartridge (VUWS-L)
- Flow rate up to 1800 l/min with VUWS-LT
- Flow rate up to 2300 l/min with VUWS-L
- Wide range of valve functions

### Flexible

- In-line valves can be used as individual valves or manifold valves
- Variable pressure zones
- Wide range of mounting options

### Reliable

- Ergonomic and safe operation
- Durable thanks to tried and tested piston spools
- Reliable servicing thanks to valves that can be replaced quickly and easily

### Easy to install

- Pre-assembled units on rails
- Individual valves assembled ready for installation
- Common supply manifolds for mounting on one or both sides
- Secure mounting on wall or H-rail

### Ordering data – Product options

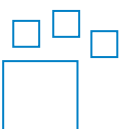

Configurable product  
This product and all its product options can be ordered using the configurator.

The configurator can be found at  
→ [www.festo.com/catalogue/...](http://www.festo.com/catalogue/...)  
Enter the part number or the type.

Part no.	Type
576517	VUWS-20
8022015	VUWS-25
8022018	VUWS-30
577304	VTUS-20
8022016	VTUS-25
8022019	VTUS-30

## Key features

### Pneumatic valves VUWS

In-line valve VUWS-L as individual valve (piston spool valve)

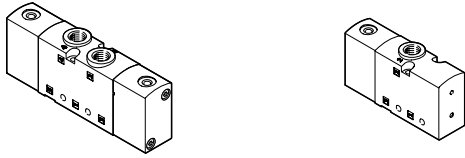

In-line valve VUWS-LT as individual valve (poppet seat valve)

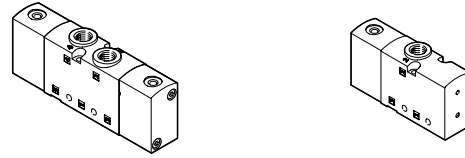

### Valve manifold assembly VTUS

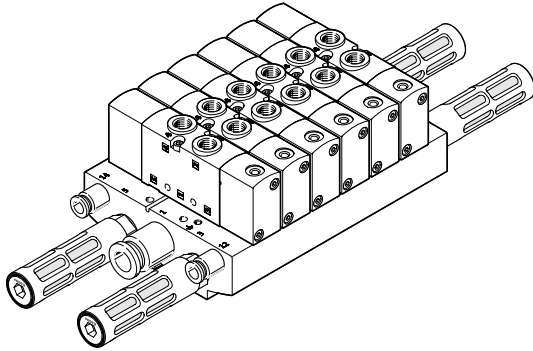

In-line valves are designed to be used without being linked pneumatically. All pneumatic connections are on the valve and can be equipped with fittings/tubing. By using a special seal set, the in-line valves can also be mounted on a manifold rail (pneumatic linking) as semi in-line valves.

Pneumatic valves VUWS have a sturdy design that enables them to be used in harsh environments.

Pneumatic valves VUWS are extremely well suited for controlling cylinders or compressed air networks for easy clamping and locking processes in semi-automatic assembly and manufacturing.

### Equipment options

VUWS-LT

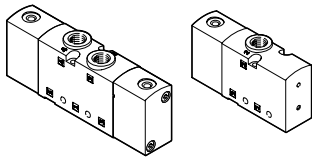

- 3/2-, 2x 3/2- and 5/2-way valves
- Size 20 (21 mm)
- Size 25 (26.5 mm)
- Size 30 (31 mm)
- In-line valves

Valve functions VUWS-LT

3/2-way valve, normally open, monostable:

- Reset via mechanical spring
- Flow direction not reversible

2x 3/2-way valve, normally closed, monostable:

- Reset via mechanical spring
- Flow direction not reversible

3/2-way valve, normally closed, monostable:

- Reset via mechanical spring
- Flow direction not reversible

2x 3/2-way valve, 1x normally open, 1x normally closed, monostable:

- Reset via mechanical spring
- Flow direction not reversible

2x 3/2-way valve, normally open, monostable:

- Reset via mechanical spring
- Flow direction not reversible

5/2-way monostable valve:

- Reset via mechanical spring
- Flow direction not reversible
- Can also be used as 3/2-way valve by closing one outlet port

5/2-way bistable valve:

- Flow direction not reversible

## Key features

### Equipment options

#### VUWS-L

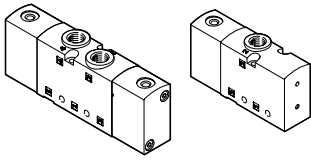

- Size 20 (21 mm)
- Size 25 (26.5 mm)
- Size 30 (31 mm)
- 3/2-, 5/2- and 5/3-way valves
- In-line valves

#### Valve functions VUWS-L

3/2-way valve, normally open, monostable:

- External pneumatic spring connection (M32U-E)
- Reset via pneumatic/mechanical spring
- Flow direction reversible with mechanical spring return or external pneumatic spring connection
- Dual-pressure operation possible
- If the external pneumatic spring connection is used as signal input, the result is a dominant bistable valve

3/2-way valve, normally closed, monostable:

- External pneumatic spring connection (M32C-E)
- Reset via pneumatic/mechanical spring
- Flow direction reversible with mechanical spring return or external pneumatic spring connection
- Dual-pressure operation possible
- If the external pneumatic spring connection is used as signal input, the result is a dominant bistable valve

5/2-way monostable valve:

- External pneumatic spring connection (M52-E)
- Reset via pneumatic/mechanical spring
- Flow direction reversible with mechanical spring return or external pneumatic spring connection
- Can also be used as 3/2-way valve by closing one outlet port

5/2-way bistable valve:

- Flow direction reversible

5/3-way valve, mid-position

exhausted, pressurised or closed:

- Flow direction reversible
- Reset via mechanical spring

### Key features

- A maximum of 16 valve positions can be configured in the standard version
- A maximum of 12 valve positions can be configured in the compact version
- Valve positions 2 ... 10 in increments of 1, valve positions 10 ... 16 in increments of 2
- Manifold block with a maximum of 10 valve positions
- Extension module with 2 valve positions
- Common supply manifold with a maximum of 10 valve positions
- Creation of pressure zones (maximum 9 pressure zones in the case of a valve manifold assembly with 16 valve positions)

### Design

#### Valve replacement

Each valve is attached to the manifold block using two screws. The appropriate seal is mounted on the valve.

This means that the valves can be easily replaced.

#### Extension

Valve positions covered with blanking plates can be replaced with valves at a later date.

The dimensions, mounting points and existing pneumatic installations remain unchanged.

For the standard manifold block, extension modules with 2 valve positions are available.

## Key features

### Standard manifold block

For 3/2-way valves

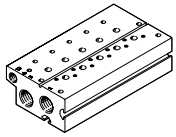

- Connection:  
Size 20: G3/8  
Size 25: G1/2  
Size 30: G3/4
- Maximum 10 valve positions

For 5/2- and 5/3-way valves

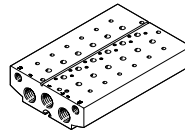

- Connection:  
Size 20: G3/8  
Size 25: G1/2  
Size 30: G3/4
- Maximum 10 valve positions

### Extension for standard manifold block

For 3/2-way valves

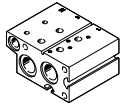

- Connection:  
Size 20: G3/8  
Size 25: G1/2  
Size 30: G3/4
- Maximum two valve positions

For 5/2- and 5/3-way valves

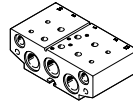

- Connection:  
Size 20: G3/8  
Size 25: G1/2  
Size 30: G3/4
- Maximum two valve positions

### Compact manifold block

For 3/2-way valves

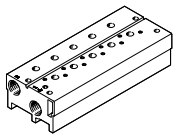

- Connection:  
Size 20: G1/4  
Size 25: G3/8  
Size 30: G1/2
- Maximum 10 valve positions

For 5/2- and 5/3-way valves

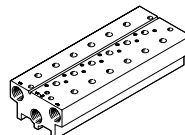

- Connection:  
Size 20: G1/4  
Size 25: G3/8  
Size 30: G1/2
- Maximum 10 valve positions

### Common supply manifold

Mounting on both sides

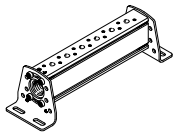

- Connection:  
Size 20: G3/8  
Size 25: G1/2  
Size 30: G3/4
- Maximum 10 valve positions

Mounting on one side

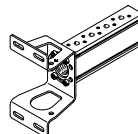

- Connection:  
Size 20: G3/8  
Size 25: G1/2  
Size 30: G3/4
- Maximum 4 valve positions

### Cover plate for vacant position

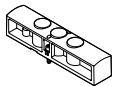

For covering unused valve positions

### Supply plate

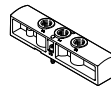

For additional air supply and exhaust via a valve position

### Separator for pressure zones



For creating pressure zones (maximum of 9 pressure zones permitted)

### Note

A filter must be installed upstream of valves operated in vacuum mode. This prevents any foreign matter in the intake air getting into the valve (e.g. when operating a suction cup with connector).

## Key features – Pneumatic components

### Creating pressure zones and separating exhaust air

Compressed air is supplied and exhausted via the manifold block/common supply manifold and via supply plates.

The position of the supply plates and duct separations can be freely selected with the VTUS.

A pressure zone is created by isolating the internal ducts between the valve positions with an appropriate separator.

The separator can be used in the following ducts:

- Duct 1
- Duct 3
- Duct 5

 **Note**

- Use a separator if the exhaust air pressures are high
- Use at least one supply plate/supply for each pressure zone

### Duct separation

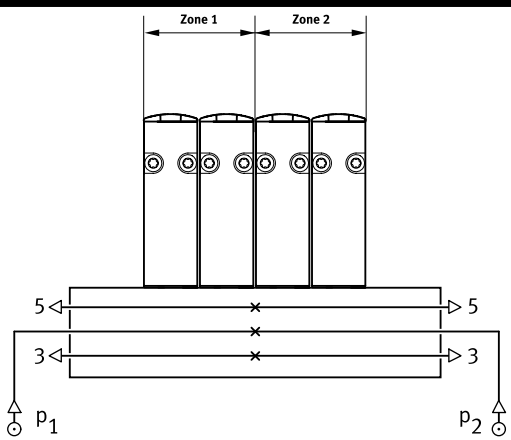

### Description

The pressure zones can be freely configured with the VTUS. The following duct separations are possible:

- Duct 1 closed

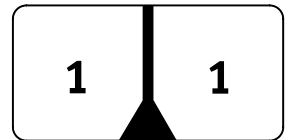

- Duct 1/3/5 closed

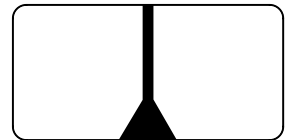

- Duct 3/5 closed

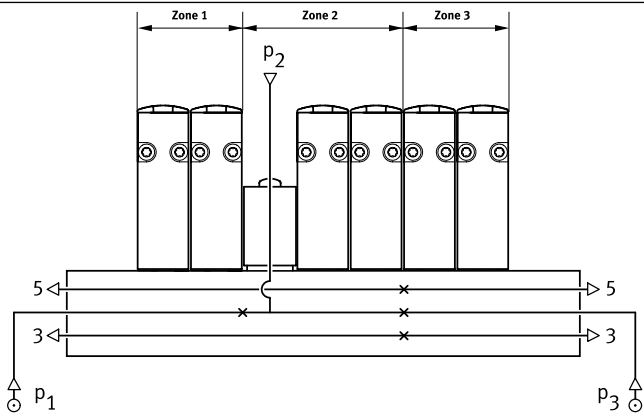
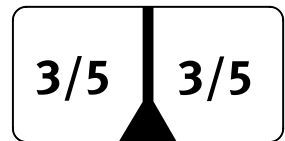

The number of pressure zones with the VTUS is limited by the number of valve positions on the manifold block/common supply manifold. Note that each supply plate occupies one valve position. There must always be at least 2 valve positions between 2 separators. In the case of a maximum extension of 16 valve positions, a maximum of 9 pressure zones can be created.

## Key features – Pneumatic components VUWS-LT

### Size 20 – Standard nominal flow rate $q_{nN}$ , with several valves $n$ switched in parallel

For 3/2-way valves

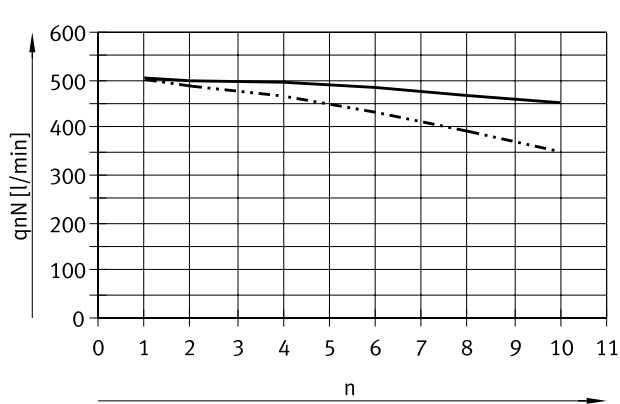

- Standard nominal flow rate per valve on standard manifold rail
- - - Standard nominal flow rate per valve on compact manifold rail

For 5/2-way valves, flow direction 1 → 2

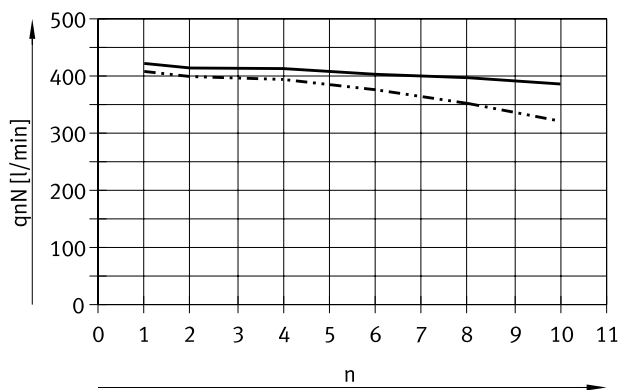

- Standard nominal flow rate per valve on standard manifold rail
- - - Standard nominal flow rate per valve on compact manifold rail

For 5/2-way valves, flow direction 1 → 4

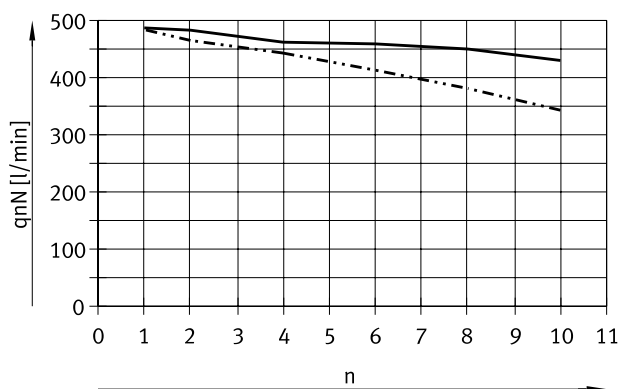

- Standard nominal flow rate per valve on standard manifold rail
- - - Standard nominal flow rate per valve on compact manifold rail

## Key features – Pneumatic components VUWS-LT

### Size 20 – Standard nominal flow rate $q_{nN}$ , with several valves $n$ switched in parallel

For 2x 3/2-way valves

One valve function per valve position in open switching position

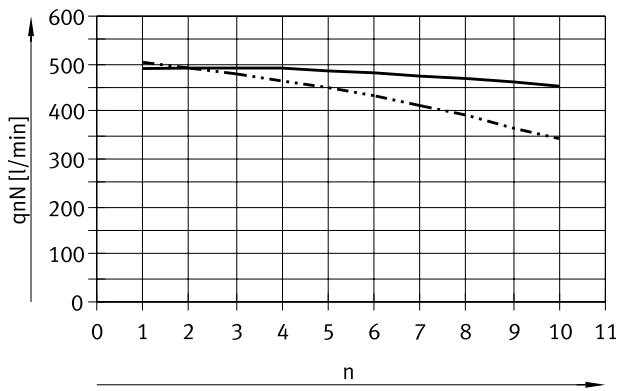

— Standard nominal flow rate per valve on standard manifold rail

- - - Standard nominal flow rate per valve on compact manifold rail

For 2x 3/2-way valves

Both valve functions per valve position simultaneously in open switching position

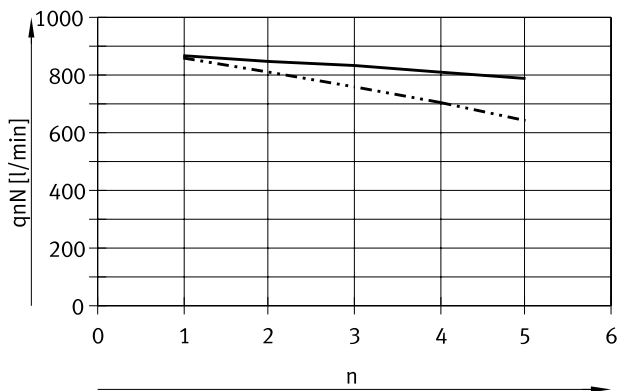

— Standard nominal flow rate per valve on standard manifold rail

- - - Standard nominal flow rate per valve on compact manifold rail



## Key features – Pneumatic components VUWS-LT

### Size 25 – Standard nominal flow rate $q_{nN}$ , with several valves $n$ switched in parallel

For 3/2-way valves

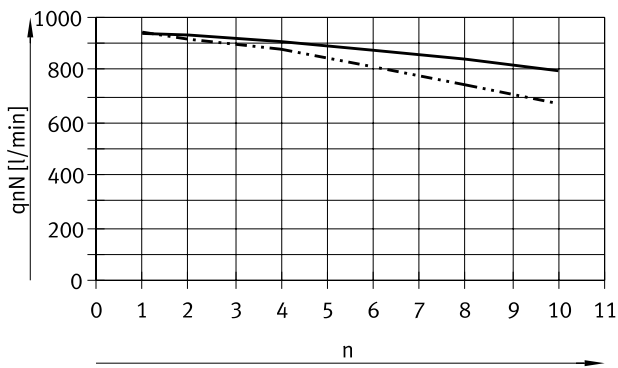

- Standard nominal flow rate per valve on standard manifold rail
- - - Standard nominal flow rate per valve on compact manifold rail

For 5/2-way valves, flow direction 1 → 2

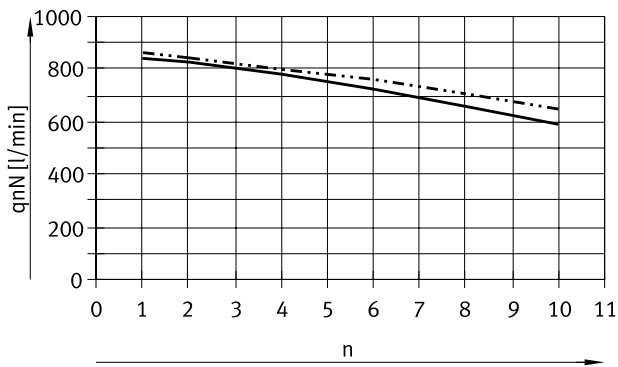

- Standard nominal flow rate per valve on standard manifold rail
- - - Standard nominal flow rate per valve on compact manifold rail

For 5/2-way valves, flow direction 1 → 4

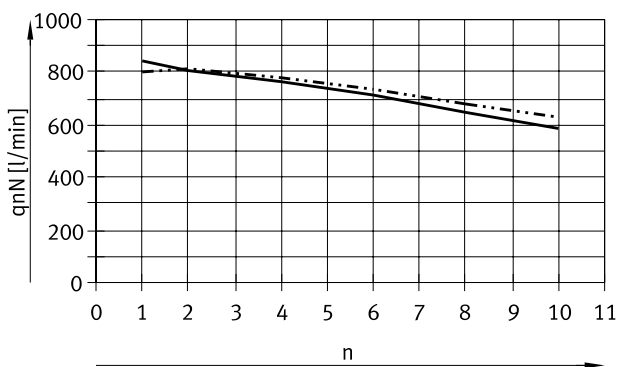

- Standard nominal flow rate per valve on standard manifold rail
- - - Standard nominal flow rate per valve on compact manifold rail

## Key features – Pneumatic components VUWS-LT

### Size 25 – Standard nominal flow rate $q_{nN}$ , with several valves $n$ switched in parallel

For 2x 3/2-way valves

One valve function per valve position in open switching position

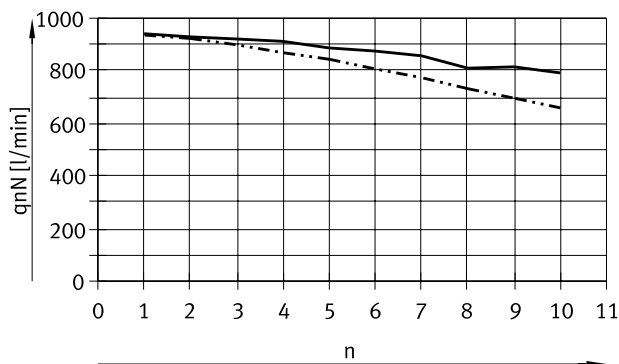

- Standard nominal flow rate per valve on standard manifold rail
- - - Standard nominal flow rate per valve on compact manifold rail

For 2x 3/2-way valves

Both valve functions per valve position simultaneously in open switching position

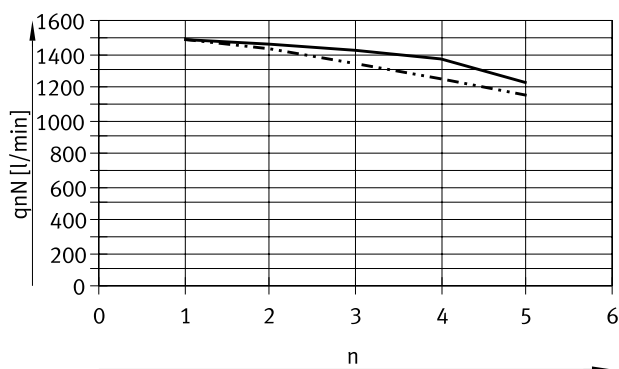

- Standard nominal flow rate per valve on standard manifold rail
- - - Standard nominal flow rate per valve on compact manifold rail

## Key features – Pneumatic components VUWS-LT

### Size 30 – Standard nominal flow rate $q_{nN}$ , with several valves $n$ switched in parallel

For 3/2-way valves

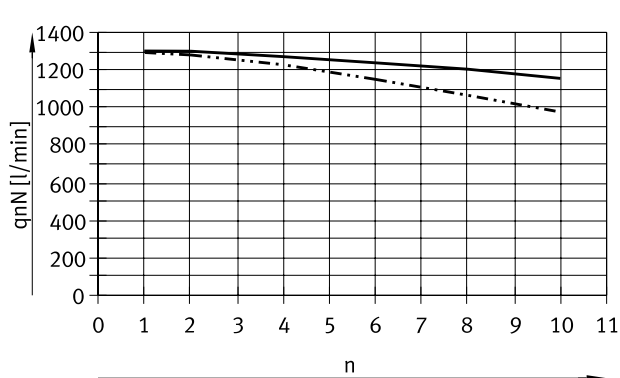

- Standard nominal flow rate per valve on standard manifold rail
- - - Standard nominal flow rate per valve on compact manifold rail

For 5/2-way valves, flow direction 1 → 2

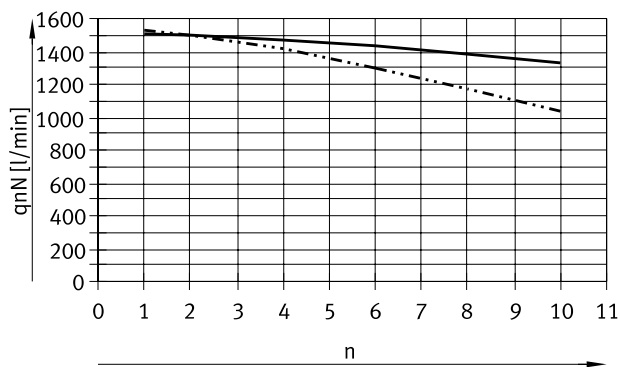

- Standard nominal flow rate per valve on standard manifold rail
- - - Standard nominal flow rate per valve on compact manifold rail

For 5/2-way valves, flow direction 1 → 4

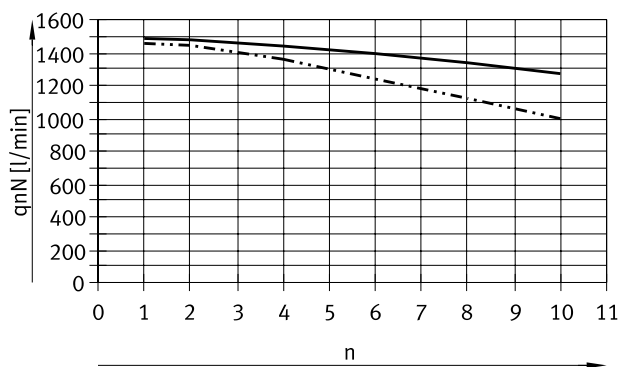

- Standard nominal flow rate per valve on standard manifold rail
- - - Standard nominal flow rate per valve on compact manifold rail

## Key features – Pneumatic components VUWS-LT

### Size 30 – Standard nominal flow rate $q_{nN}$ , with several valves $n$ switched in parallel

For 2x 3/2-way valves

One valve function per valve position in open switching position

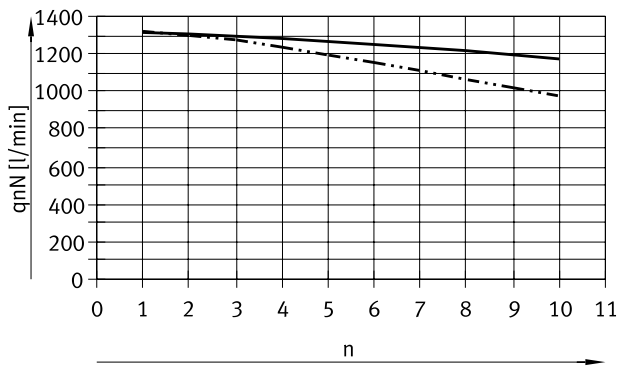

— Standard nominal flow rate per valve on standard manifold rail

- · - · - Standard nominal flow rate per valve on compact manifold rail

For 2x 3/2-way valves

Both valve functions per valve position simultaneously in open switching position

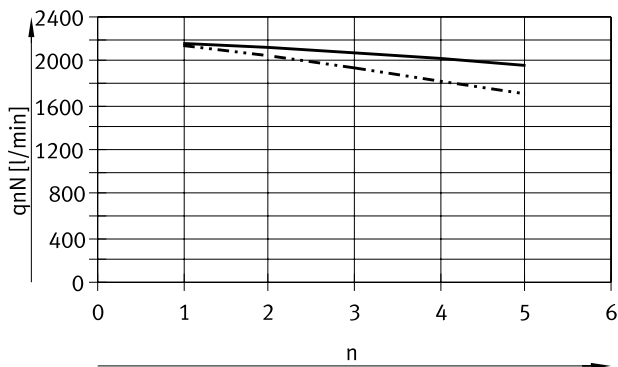

— Standard nominal flow rate per valve on standard manifold rail

- · - · - Standard nominal flow rate per valve on compact manifold rail

### Key features – Pneumatic components VUWS-L

#### Size 20 – Standard nominal flow rate $q_{nN}$ , with several valves $n$ switched in parallel

For 3/2-way valves

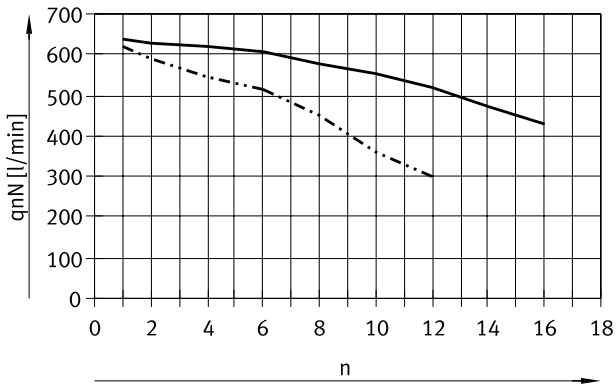

———— Standard nominal flow rate per valve on standard manifold rail

- · - · - · Standard nominal flow rate per valve on compact manifold rail

For 5/2- and 5/3-way valves

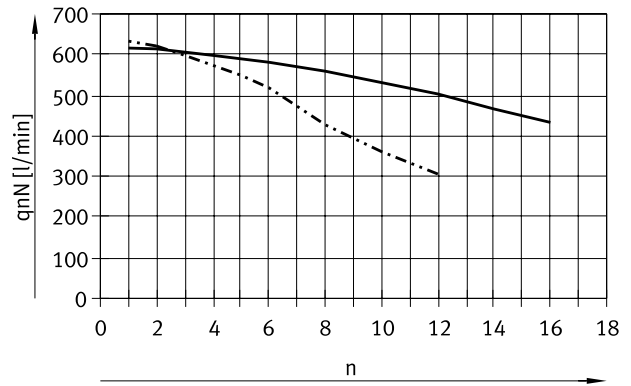

———— Standard nominal flow rate per valve on standard manifold rail

- · - · - · Standard nominal flow rate per valve on compact manifold rail

#### Size 25 – Standard nominal flow rate $q_{nN}$ , with several valves $n$ switched in parallel

For 3/2-way valves

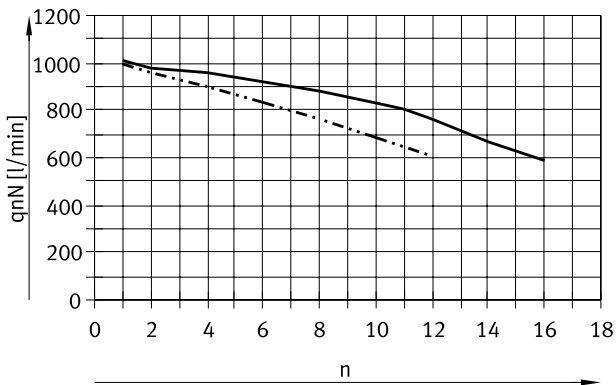

———— Standard nominal flow rate per valve on standard manifold rail

- · - · - · Standard nominal flow rate per valve on compact manifold rail

For 5/2- and 5/3-way valves

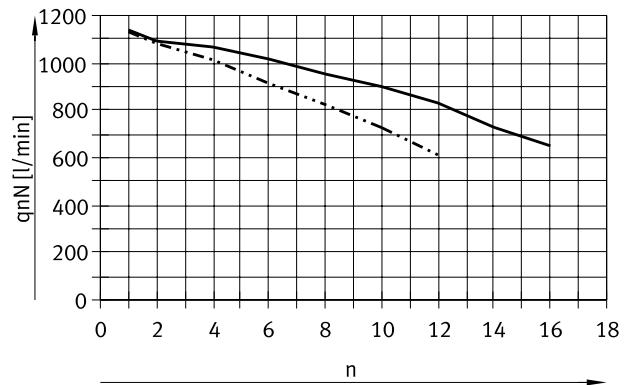

———— Standard nominal flow rate per valve on standard manifold rail

- · - · - · Standard nominal flow rate per valve on compact manifold rail

## Key features – Pneumatic components VUWS-L

### Size 30 – Standard nominal flow rate $q_{nN}$ , with several valves $n$ switched in parallel

For 3/2-way valves

For 5/2- and 5/3-way valves

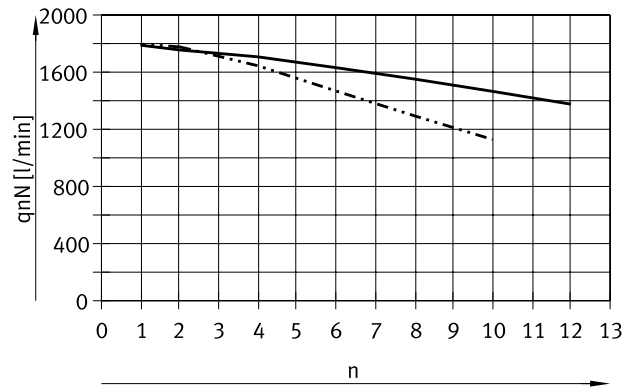
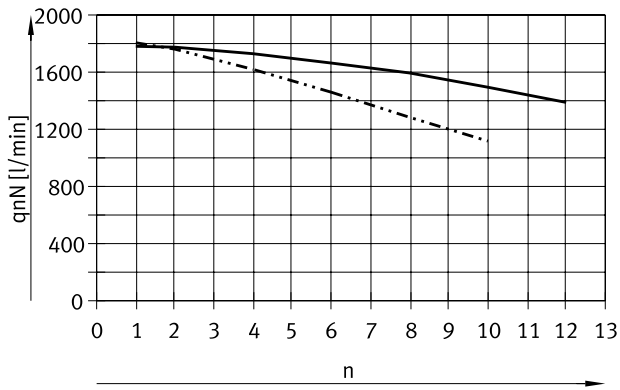

— Standard nominal flow rate per valve on standard manifold rail

- - - Standard nominal flow rate per valve on compact manifold rail

— Standard nominal flow rate per valve on standard manifold rail

- - - Standard nominal flow rate per valve on compact manifold rail

## Key features – VUWS-LT pneumatics

**Size 20 – Pilot pressure p2 as a function of working pressure p1**

For 3/2-way valves

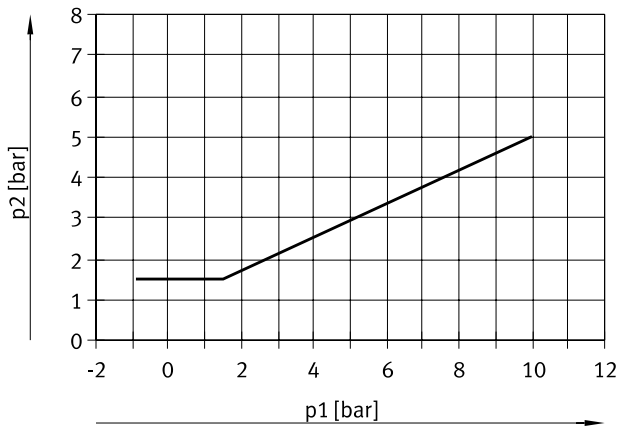
**Size 25 – Pilot pressure p2 as a function of working pressure p1**

For 3/2-way valves

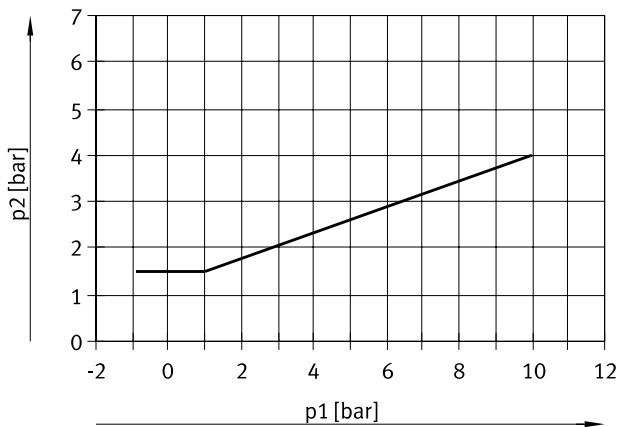

## Key features – VUWS-LT pneumatics

### Size 30 – Pilot pressure $p_2$ as a function of working pressure $p_1$

For 3/2-way valves

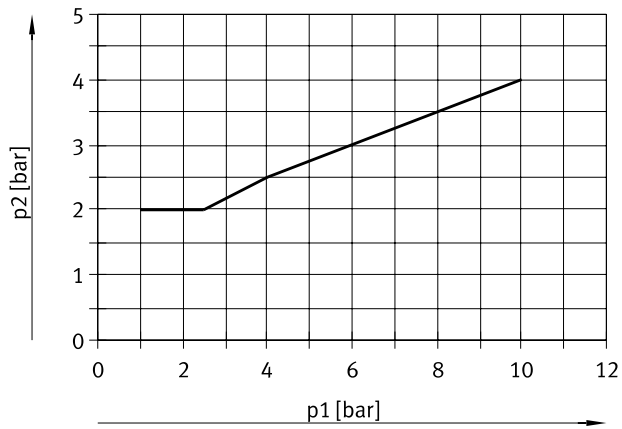

For 5/2-way monostable valves



For 5/2-way bistable valves

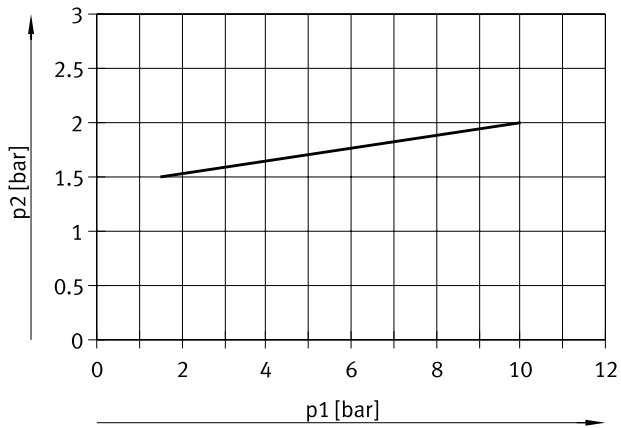



## Key features – Mounting

### Mounting the valve manifold assembly

- Sturdy manifold assembly thanks to:
- Four through-holes for wall mounting
  - H-rail mounting



**Note**

Use the thread M4 (M5 for size 30) provided on the manifold block for earthing the valve manifold assembly.

### Wall mounting

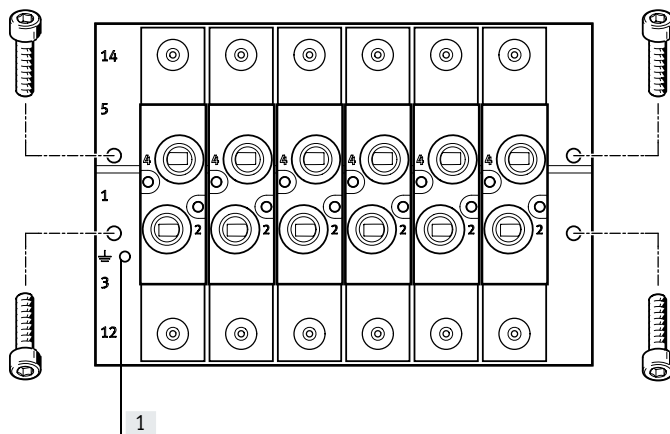

Sturdy wall mounting of the manifold block using four through-holes.

[1] Earth terminal

### H-rail mounting

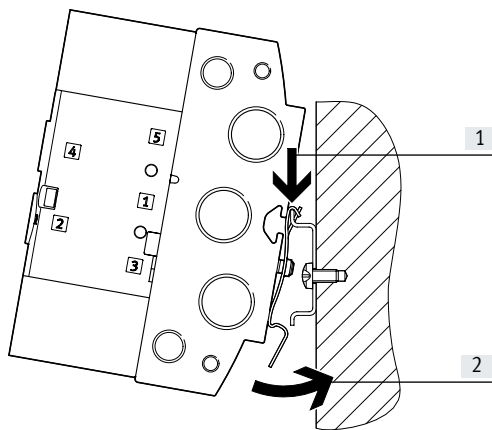

The H-rail mounting VAME-T-M... consists of two mounting clips. These are screwed to the manifold block on the left and right.

The prepared manifold block is then lowered onto the H-rail from above (arrow 1) and clipped into the H-rail at the bottom (arrow 2).

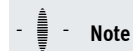

**Note**

- Note the max. tightening torque of the screws for H-rail mounting.
- Only horizontal H-rail mounting is permissible
- Mounting only permissible on H-rail TH 35-... to EN 60715
- Vibration/shock loads are not permissible with H-rail mounting.
- Further information on assembly → Assembly instructions for H-rail mounting VAME-T-M...

## Key features – Mounting

### Mounting individual valve VUWS

#### Wall mounting

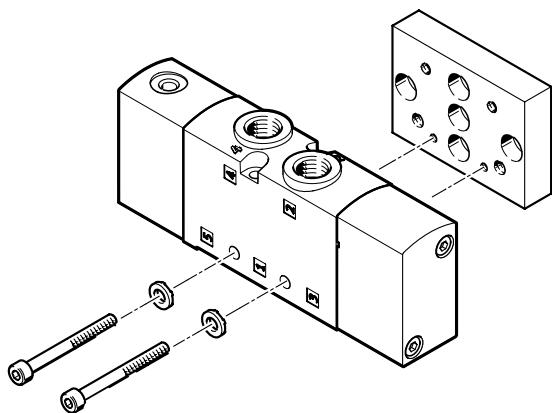

For mounting individual valves on a flat surface, e.g. aluminium profile systems.  
The pneumatic valves are provided with two through-holes for attaching to the wall mounting VAME-B10-20-W.

The screw set required is included with the wall mounting VAME-B10-20-W.  
The wall mounting VAME-B10-20-W can be used for sizes 20, 25 and 30.

#### Foot mounting

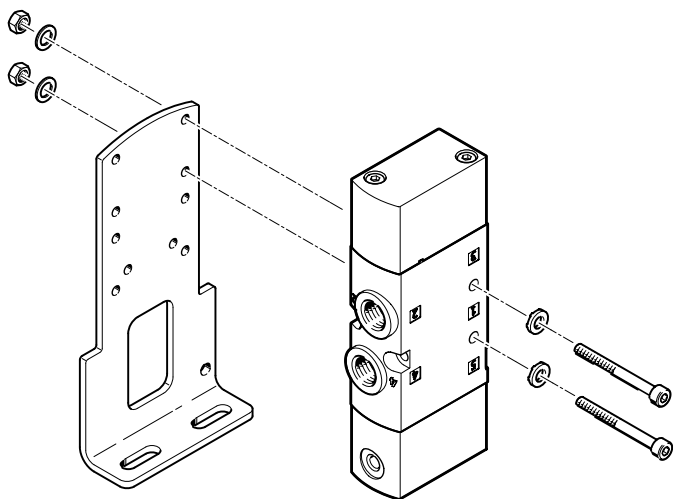

For mounting individual valves on a flat surface, e.g. aluminium profile systems.  
The pneumatic valves are provided with two through-holes for attaching to the foot mounting VAME-B10-...-A.

The screw set required is included with the foot mounting VAME-B10-...-A.



#### Note

Further mounting options for foot mounting VAME-B10-...-A  
→ Data sheet – Pneumatic valves, dimensions

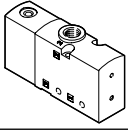
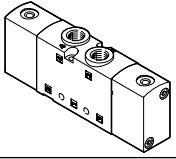
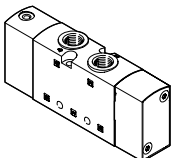
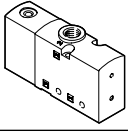
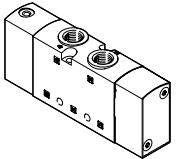
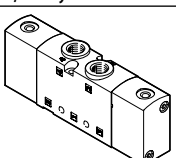
Product range overview

Design	Size	Working port	Order code for valves and flow rate [l/min]										→ Page/ Internet
			M32C	M32U	T32C	T32U	T32H	M52	B52	P53C	P53E	P53U	
<b>3/2-way valve VUWS-LT</b>													
	20	G1/8	600	600	-	-	-	-	-	-	-	-	44
	25	G1/4	1000	1000	-	-	-	-	-	-	-	-	61
	30	G3/8	1600	1600	-	-	-	-	-	-	-	-	64
<b>2x 3/2-way valve VUWS-LT</b>													
	20	G1/8	-	-	600	600	600	-	-	-	-	-	44
	25	G1/4	-	-	1000	1000	1000	-	-	-	-	-	61
	30	G3/8	-	-	1600	1600	1600	-	-	-	-	-	64
<b>5/2-way valve VUWS-LT</b>													
	20	G1/8	-	-	-	-	-	500	500	-	-	-	44
	25	G1/4	-	-	-	-	-	1000	1000	-	-	-	61
	30	G3/8	-	-	-	-	-	1800	1800	-	-	-	64
<b>3/2-way valve VUWS-L</b>													
	20	G1/8	700	700	-	-	-	-	-	-	-	-	82
	25	G1/4	1000	1000	-	-	-	-	-	-	-	-	92
	30	G3/8	2300	2300	-	-	-	-	-	-	-	-	102
<b>5/2-way valve VUWS-L</b>													
	20	G1/8	-	-	-	-	-	700	700	-	-	-	82
	25	G1/4	-	-	-	-	-	1300	1300	-	-	-	92
	30	G3/8	-	-	-	-	-	2300	2300	-	-	-	102
<b>5/3-way valve VUWS-L</b>													
	20	G1/8	-	-	-	-	-	-	-	700	600	600	82
	25	G1/4	-	-	-	-	-	-	-	1200	1000	1000	92
	30	G3/8	-	-	-	-	-	-	-	2000	1600	1600	102

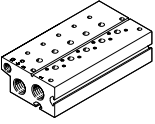
## Product range overview

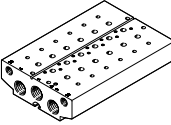
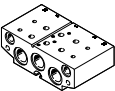
Design	Size	Description		→ Page/ Internet
<b>Manifold block for 3/2-way valves, standard</b>				
	20	VABM-B10-20E-G38- ... -P3	Connection G3/8	112
	25	VABM-B10-25E-G12- ... -P3	Connection G1/2	125
	30	VABM-B10-30E-G34- ... -P3	Connection G3/4	138
<b>Manifold block extension module for 3/2-way valves, standard</b>				
	20	VABM-B10-20EEE-G38- ... -P3	Connection G3/8	112
	25	VABM-B10-25EEE-G12- ... -P3	Connection G1/2	125
	30	VABM-B10-30EEE-G34- ... -P3	Connection G3/4	138
<b>Manifold block for 5/2- and 5/3-way valves, standard</b>				
	20	VABM-B10-20E-G38- ...	Connection G3/8	112
	25	VABM-B10-25E-G12- ...	Connection G1/2	125
	30	VABM-B10-30E-G34- ...	Connection G3/4	138
<b>Manifold block extension module for 5/2- and 5/3-way valves, standard</b>				
	20	VABM-B10-20EEE-G38- ...	Connection G3/8	112
	25	VABM-B10-25EEE-G12- ...	Connection G1/2	125
	30	VABM-B10-30EEE-G34- ...	Connection G3/4	138

## Product range overview

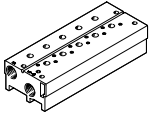
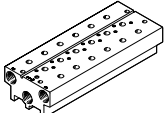
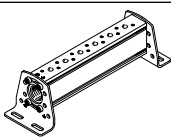
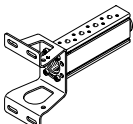
Design	Size	Description		→ Page/ Internet
<b>Manifold block for 3/2-way valves, compact</b>				
	20	VABM-B10-20S-G14- ...-P3	Connection G1/4	112
	25	VABM-B10-25S-G38- ...-P3	Connection G3/8	125
	30	VABM-B10-30S-G12- ...-P3	Connection G1/2	138
<b>Manifold block for 5/2- and 5/3-way valves, compact</b>				
	20	VABM-B10-20S-G14- ...	Connection G1/4	112
	25	VABM-B10-25S-G38- ...	Connection G3/8	125
	30	VABM-B10-30S-G12- ...	Connection G1/2	138
<b>Common supply manifold, for mounting on both sides</b>				
	20	VABM-B10-20-G38- ... -P53	Connection G3/8	113
	25	VABM-B10-25-G12- ... -P53	Connection G1/2	126
	30	VABM-B10-30-G34- ... -P53	Connection G3/4	139
<b>Common supply manifold, for mounting on one side</b>				
	20	VABM-B10-20-G38- ... -P53-E	Connection G3/8	113
	25	VABM-B10-25-G12- ... -P53-E	Connection G1/2	126
	30	VABM-B10-30-G34- ... -P53-E	Connection G3/4	139

## Valve function

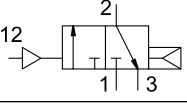
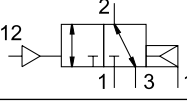
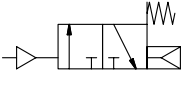
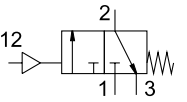
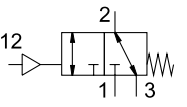
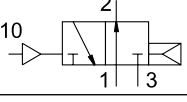
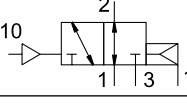
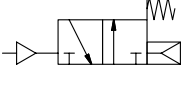
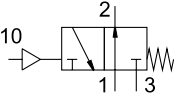
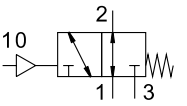
Valve	Order code for valves	Description	VUWS-LT			VUWS-L		
			Size			Size		
			20	25	30	20	25	30
<b>3/2-way valve, normally closed, pneumatic spring</b>								
	M32C-A	<ul style="list-style-type: none"> <li>Internal pneumatic spring supply</li> <li>Flow direction: not reversible</li> </ul>	-	-	-	■	■	■
	M32C-E	<ul style="list-style-type: none"> <li>External pneumatic spring supply</li> <li>Flow direction: reversible</li> </ul>	-	-	-	■	■	■
<b>3/2-way valve, normally closed, pneumatic/mechanical spring</b>								
	M32C-M	<ul style="list-style-type: none"> <li>Flow direction: not reversible</li> <li>Reset: mechanical spring, supported internally by pneumatic spring</li> </ul>	-	-	-	■	-	-
<b>3/2-way valve, normally closed, mechanical spring</b>								
	M32C-M	Flow direction: not reversible	■	■	■	-	-	-
	M32C-M	Flow direction: reversible	-	-	-	-	■	■
<b>3/2-way valve, normally open, pneumatic spring</b>								
	M32U-A	<ul style="list-style-type: none"> <li>Internal pneumatic spring supply</li> <li>Flow direction: not reversible</li> <li>Reset: pneumatic spring</li> </ul>	-	-	-	■	■	■
	M32U-E	<ul style="list-style-type: none"> <li>External pneumatic spring supply</li> <li>Flow direction: reversible</li> <li>Reset: pneumatic spring</li> </ul>	-	-	-	■	■	■
<b>3/2-way valve, normally open, pneumatic/mechanical spring</b>								
	M32U-M	<ul style="list-style-type: none"> <li>Flow direction: not reversible</li> <li>Reset: mechanical spring, supported internally by pneumatic spring</li> </ul>	-	-	-	■	-	-
<b>3/2-way valve, normally open, mechanical spring</b>								
	M32U-M	Flow direction: not reversible	■	■	■	-	-	-
	M32U-M	Flow direction: reversible	-	-	-	-	■	■

## Valve function

Valve	Order code for valves	Description	VUWS-LT			VUWS-L		
			Size			Size		
			20	25	30	20	25	30
<b>2x 3/2-way valve, normally closed, mechanical spring</b>								
	T32C	<ul style="list-style-type: none"> <li>Internal pilot air supply</li> <li>Flow direction: not reversible</li> </ul>	■	■	■	-	-	-
<b>2x 3/2-way valve, normally open, mechanical spring</b>								
	T32U	<ul style="list-style-type: none"> <li>Internal pilot air supply</li> <li>Flow direction: not reversible</li> </ul>	■	■	■	-	-	-
<b>2x 3/2-way valve, 1x normally open, 1x normally closed, mechanical spring</b>								
	T32H	<ul style="list-style-type: none"> <li>Internal pilot air supply</li> <li>Flow direction: not reversible</li> </ul>	■	■	■	-	-	-

Valve function

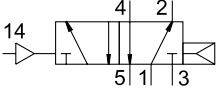
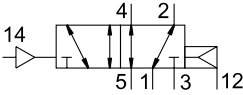
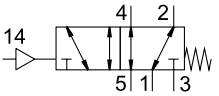
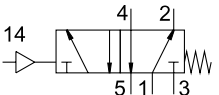
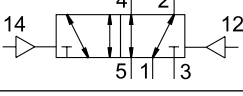
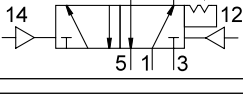
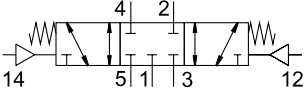
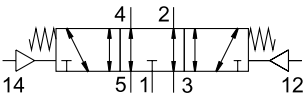
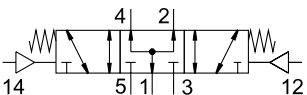
Valve	Order code for valves	Description	VUWS-LT			VUWS-L		
			Size			Size		
			20	25	30	20	25	30
<b>5/2-way valve, pneumatic spring, monostable</b>								
	M52-A	<ul style="list-style-type: none"> <li>Internal pneumatic spring supply</li> <li>Flow direction: not reversible</li> </ul>	-	-	-	■	■	■
	M52-E	<ul style="list-style-type: none"> <li>External pneumatic spring supply</li> <li>Flow direction: reversible</li> </ul>	-	-	-	■	■	■
<b>5/2-way valve, mechanical spring, monostable</b>								
	M52-M	Flow direction: reversible	-	-	-	■	■	■
	M52-M	Flow direction: not reversible	■	■	■	-	-	-
<b>5/2-way bistable valve</b>								
	B52	Flow direction: reversible	-	-	-	■	■	■
	B52	<ul style="list-style-type: none"> <li>Flow direction: not reversible</li> <li>Holding the switching position: via latch</li> </ul>	■	■	■	-	-	-
<b>5/3-way valve, mid-position closed</b>								
	P53C	Flow direction: reversible	-	-	-	■	■	■
<b>5/3-way valve, mid-position exhausted</b>								
	P53E	Flow direction: reversible	-	-	-	■	■	■
<b>5/3-way valve, mid-position pressurised</b>								
	P53U	Flow direction: reversible	-	-	-	■	■	■



## Peripherals overview VUWS-LT, VUWS-L

Manifold block for 3/2-way valves

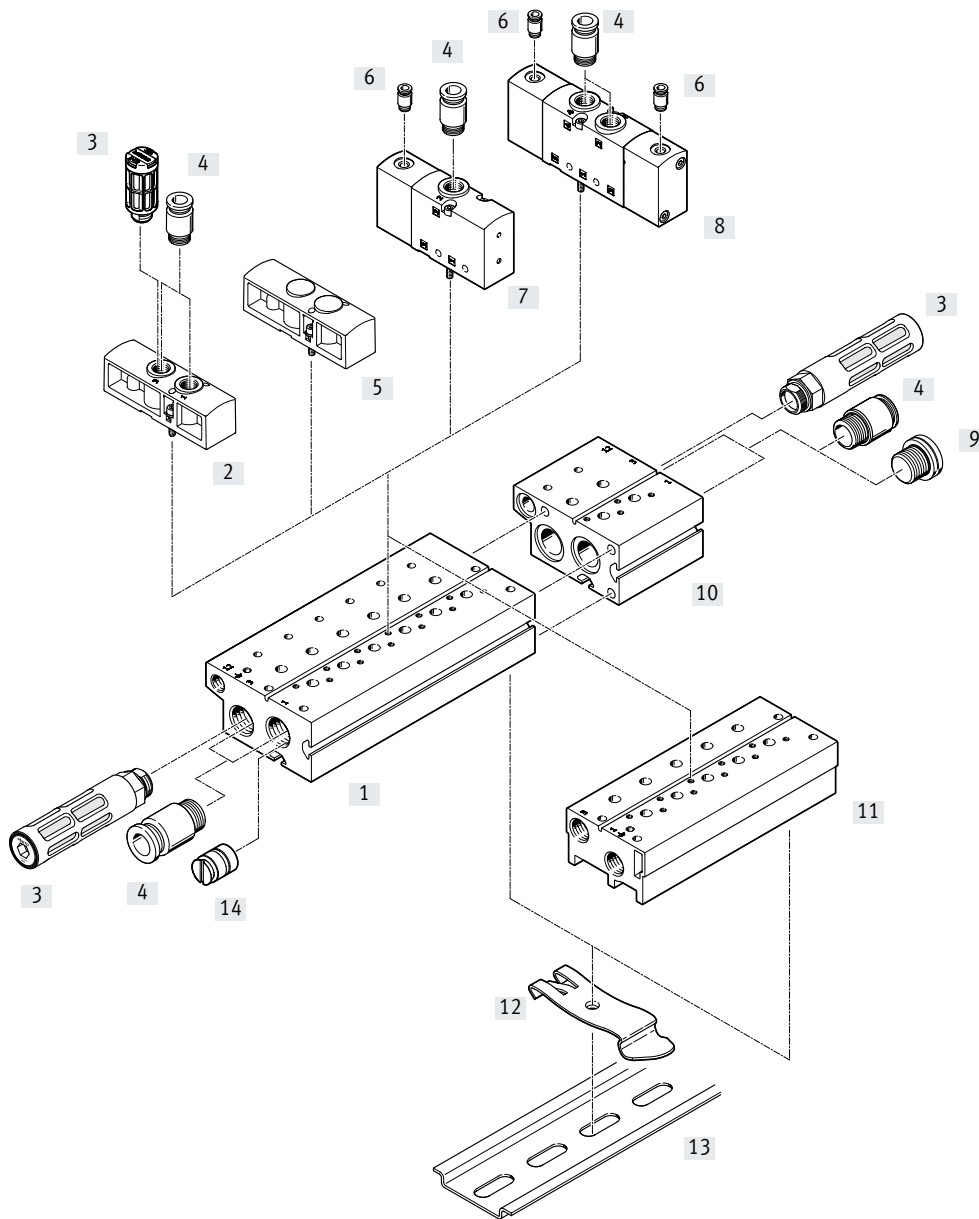

Accessories			
Designation		Brief description	→ Page/Internet
[1]	Standard manifold block	For 3/2-way valves	112
[2]	Supply plate	For 3/2-way valves	114
[3]	Silencer	For exhaust ports (3)	116
[4]	Push-in fitting	For supply/exhaust ports (1, 3)	83
[5]	Blanking plate	VABB-B10-...	114
[6]	Push-in fitting	M5 for pilot air port	83
[7]	Pneumatic valve	3/2-way valve	61
[8]	Pneumatic valve	2x 3/2-way valve (VUWS-LT...)	54
[9]	Blanking plug	For supply/exhaust ports (1, 3)	116
[10]	Standard manifold block extension module	For 3/2-way valves	112
[11]	Compact manifold block	For 3/2-way valves	112
[12]	H-rail mounting	For mounting on standard H-rails	116
[13]	Standard H-rail	Mounting rail to EN 60715	-
[14]	Separator	For creating pressure zones (in duct 1 and/or 3)	116

Peripherals overview VUWS-LT, VUWS-L

Manifold block for 5/2 and 5/3-way valves

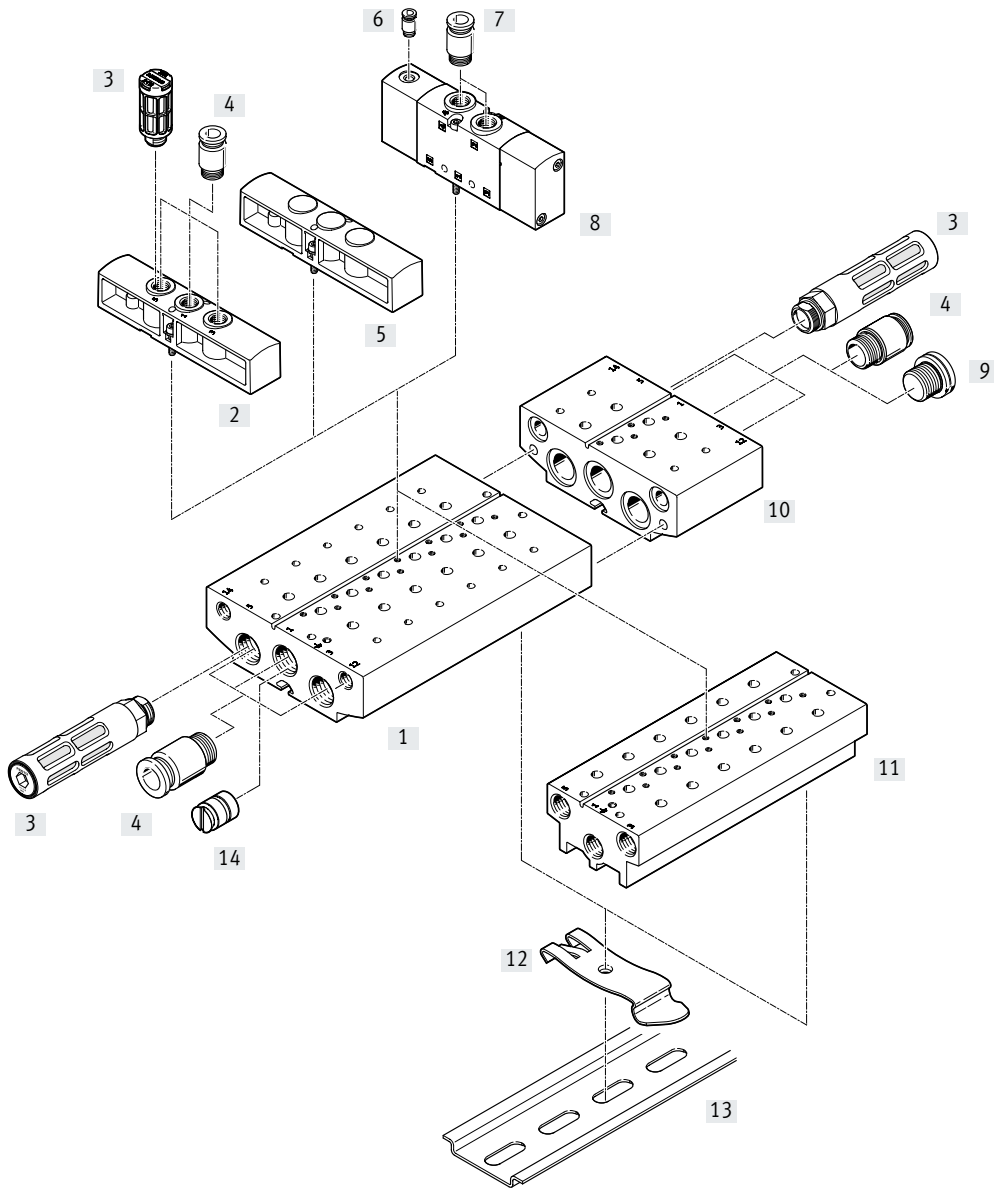

Accessories		
Designation	Brief description	→ Page/Internet
[1] Standard manifold block	For 5/2- and 5/3-way valves	112
[2] Supply plate	For 5/2- and 5/3-way valves	114
[3] Silencer	For exhaust ports (5 and/or 3)	116
[4] Push-in fitting	For supply/exhaust ports (1, 3, 5)	83
[5] Blanking plate	VABB-B10-...	114
[6] Push-in fitting	M5 for pilot air port	83
[7] Push-in fitting	For working ports (2, 4)	83
[8] Pneumatic valve	5/2-way, 5/3-way valve	61
[9] Blanking plug	For supply/exhaust ports (1, 3, 5)	116
[10] Standard manifold block extension module	For 5/2- and 5/3-way valves	112
[11] Compact manifold block	For 5/2- and 5/3-way valves	112
[12] H-rail mounting	For mounting on standard H-rails	116
[13] Standard H-rail	Mounting rail to EN 60715	-
[14] Separator	For creating pressure zones (in ducts 1, 3, 5)	116

## Peripherals overview VUWS-LT, VUWS-L

### Common supply manifold for mounting on both sides

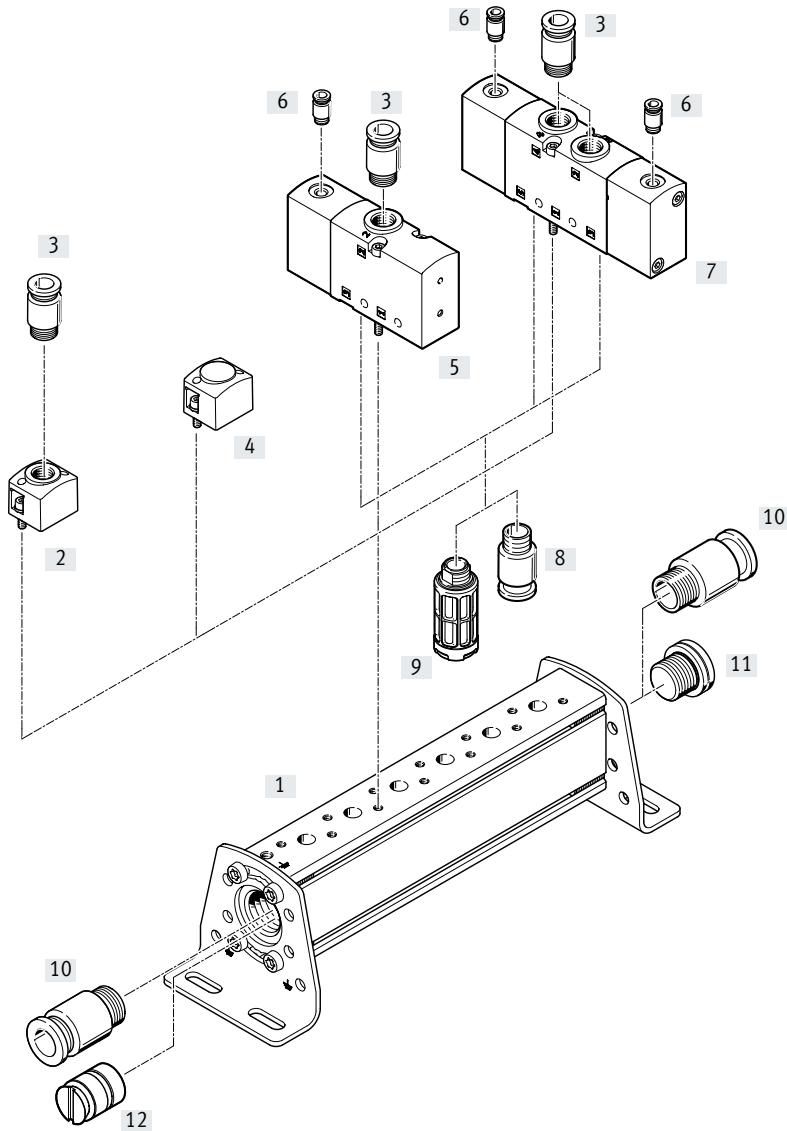

Accessories			
Designation		Brief description	→ Page/Internet
[1]	Common supply manifold	For mounting on both sides Mounting bracket can be adjusted through $\pm 30^\circ$ .	113
[2]	Supply plate/air supply plate	For supplying working air (1) (VABF-B10-...-P1...)	114
[3]	Push-in fitting	For supplying air (1) for working ports (2, 4)	83
[4]	Blanking plate	VABB-B10-...	114
[5]	Pneumatic valve	3/2-way valve	82
[6]	Push-in fitting	M5 for pilot air port	83
[7]	Pneumatic valve	5/2-way, 5/3-way valve 2x 3/2-way valve (VUWS-LT...)	61 54
[8]	Push-in fitting	For exhaust ports (3, 5)	83
[9]	Silencer	For exhaust ports (3, 5)	116
[10]	Push-in fitting	For supplying air (1)	115
[11]	Blanking plug	For working port (duct 1)	116
[12]	Separator	For creating pressure zones (in duct 1)	116

## Peripherals overview VUWS-LT, VUWS-L

### Common supply manifold for mounting on one side

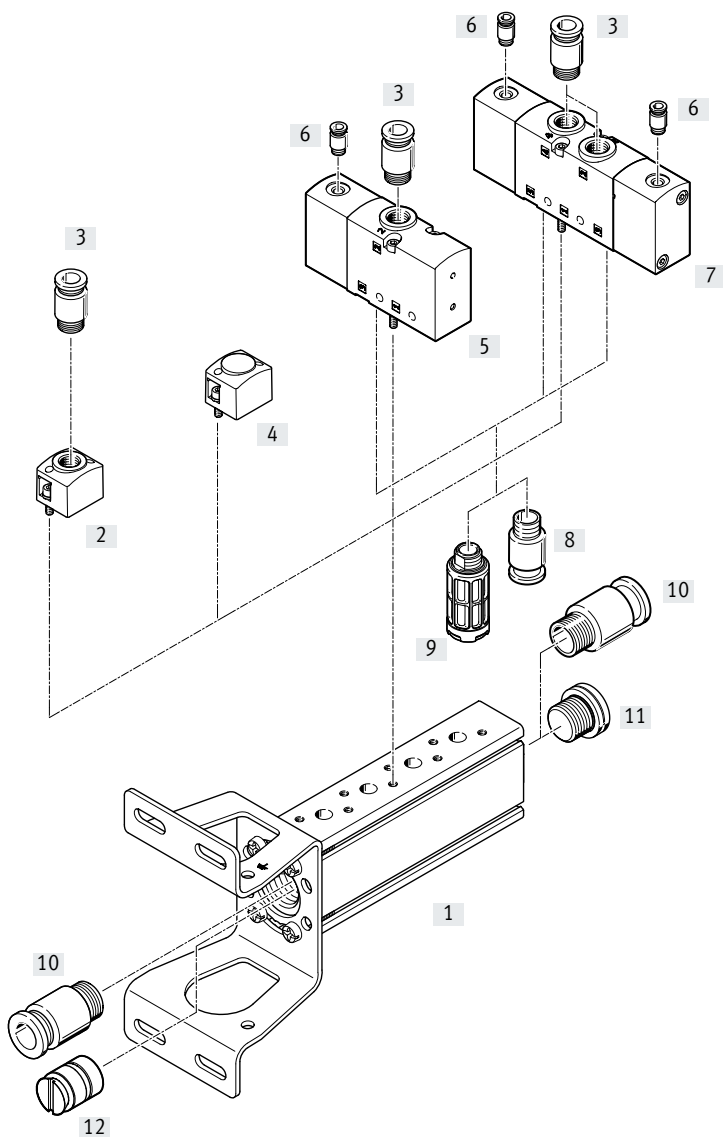

Accessories		
Designation	Brief description	→ Page/Internet
[1] Common supply manifold	For mounting on one side Mounting bracket can be adjusted through $\pm 30^\circ$ .	113
[2] Supply plate/air supply plate	For supplying working air (1) (VABF-B10-...-P1...)	114
[3] Push-in fitting	For supplying air (1) for working ports (2, 4)	83
[4] Blanking plate	VABB-B10-...	114
[5] Pneumatic valve	3/2-way valve	82
[6] Push-in fitting	M5 for pilot air port	83
[7] Pneumatic valve	5/2-way, 5/3-way valve 2x 3/2-way valve (VUWS-LT...)	61 54
[8] Push-in fitting	For exhaust ports (3, 5)	83
[9] Silencer	For exhaust ports (3, 5)	116
[10] Push-in fitting	For supplying air (1)	115
[11] Blanking plug	For working port (duct 1)	116
[12] Separator	For creating pressure zones (in duct 1)	116

## Data sheet – Valve manifold assembly

-  - Flow rate  
 Size 20:  
 up to 700 l/min  
 Size 25:  
 up to 1300 l/min  
 Size 30  
 up to 2300 l/min



General technical data			20	25	30
Size			20	25	30
Valve manifold design			Fixed grid		
Valve width		[mm]	21	26.5	31
Valve design	VUWS-L		Piston spool	Piston spool	Piston spool
	VUWS-LT		Poppet seat	Poppet seat	Poppet seat
Reset method for valves	VUWS-L		Pneumatic or mechanical spring		
	VUWS-LT		Mechanical spring		
Pneumatic spring			Internal or external		
Flow direction	VUWS-L		Reversible with restrictions		
	VUWS-LT		Non-reversible		
Suitable for vacuum	VUWS-L		Yes, with restrictions		
	VUWS-LT		Yes, with restrictions		No
Type of control			Direct		
Manual override (MO)			None		
Overlap	VUWS-L		Positive overlap		
	VUWS-LT		Negative overlap		
Sealing principle			Soft		
Max. no. of valve positions			16 (a maximum of 18 valve positions with extension for standard manifold block)		
Max. number of pressure zones			9		
Exhaust function			Can be throttled		
Type of actuation			Pneumatic		
Standard nominal flow rate [qnN]		[l/min]	500...700	1000...1300	1600...2300
Pilot air connection	Standard manifold block	12/14	G1/8		
	Compact manifold block	12/14	On the valve		
	Common supply manifold	12/14	On the valve		
Pilot exhaust air port		82/84	M5		
Mounting position			Any		
<b>Materials</b>					
Note on materials			RoHS-compliant		
Information on materials - seals	VUWS-L		HNBR, NBR		
	VUWS-LT		HNBR, NBR, TPE-U(PU)		

Data sheet – Valve manifold assembly

ATEX							
ATEX category for gas	II 3G						
Type of ignition protection for gas	Ex ec IICT4 X Gc						
ATEX category for dust	II 3D						
Type of ignition protection for dust	Ex tc IIICT115°C X Dc						
Explosion-proof ambient temperature [°C]	-10°C ≤ Ta ≤ +60°C						
CE marking (see declaration of conformity)	To EU Explosion Protection Directive (ATEX)						
Operating and environmental conditions							
Valve design	Piston spool			Poppet seat			
Size	20	25	30	20	25	30	
Operating medium	Compressed air to ISO 8573-1:2010 [7:4:4]						
Pilot medium	Compressed air to ISO 8573-1:2010 [7:4:4]						
Note on operating/pilot medium	Lubricated operation possible (in which case lubricated operation will always be required)						
Operating pressure [MPa]	-0.09 ... +1	-0.09 ... +1	-0.09 ... +1	-0.09 ... +1 (M32, T32)	-0.09 ... +1 (M32, T32)	-	
	-	-	-	-	-	+0.1 ... +1 (32)	
	-	-	-	+0.15 ... +1 (B52)	+0.15 ... +1 (B52)	+0.15 ... +1 (B52)	
	+0.25 ... +1 (M32...-A, M32...-M,, M52-A)	+0.25 ... +1 (M...-A, M52)	+0.25 ... +1 (M...-A)	+0.25 ... +1 (M52)	+0.25 ... +1 (M52)	+0.25 ... +1 (M52)	
	[bar]	-0.9 ... +10	-0.9 ... +10	-0.9 ... +10	-0.9 ... +10 (M32, T32)	-0.9 ... +10 (M32, T32)	-
	-	-	-	-	-	+1.0 ... +10 (32)	
	+2.5 ... +10 (M32...-A, M32...-M, M52-A)	+2.5 ... +10 (M...-A, M52)	+2.5 ... +10 (M...-A)	+2.5 ... +10 (M52)	+2.5 ... +10 (M52)	+2.5 ... +10 (M52)	
Pilot pressure [MPa]	0.15 ... 1 (B52)	0.15 ... 1 (B52)	0.15 ... 1 (B52)	0.15 ... 1	0.15 ... 1 (B52)	0.15 ... 1 (B52)	
	0.25 ... 1	0.25 ... 1	0.25 ... 1	0.25 ... 1 (M52)	0.25 ... 1	0.25 ... 1	
	[bar]	1.5 ... 10 (B52)	1.5 ... 10 (B52)	1.5 ... 10 (B52)	1.5 ... 10	1.5 ... 10 (B52)	
	2.5 ... 10	2.5 ... 10	2.5 ... 10	2.5 ... 10 (M52)	2.5 ... 10	2.5 ... 10	
Ambient temperature [°C]	-10 ... +60						
Temperature of medium [°C]	-10 ... +60						
Certification	c UL us - Recognized (OL)						
Corrosion resistance class CRC <sup>1)</sup>	2						

1) More information: [www.festo.com/x/topic/kbk](http://www.festo.com/x/topic/kbk)

## Data sheet

## Dimensions

Download CAD data → [www.festo.com](http://www.festo.com)

With 3/2-way valves, standard manifold rail

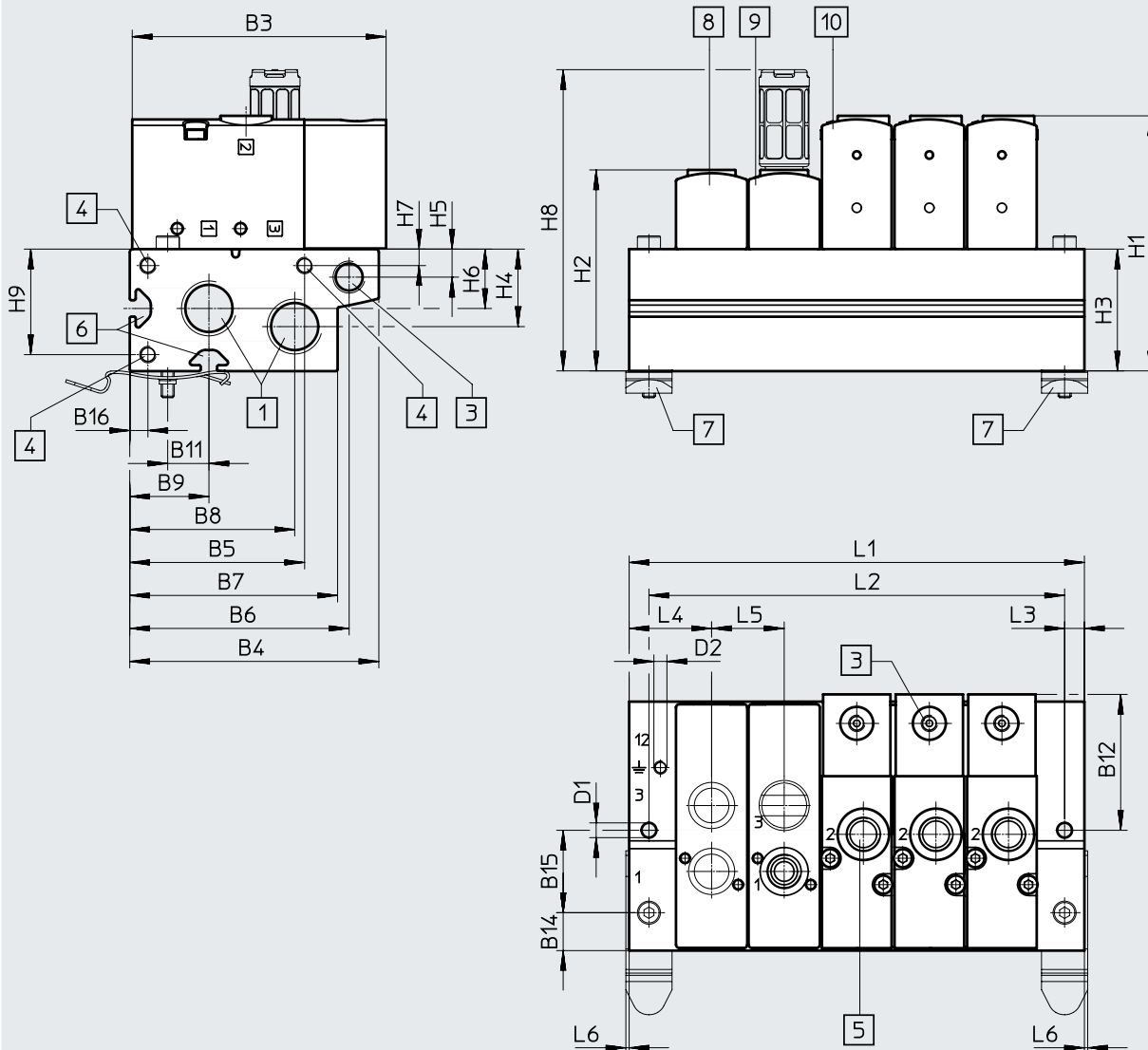

- |  |   |   |  |
|--|---|---|--|
| [1] Ports 1 and 3 (at both ends):<br>G3/8 for VTUS 20<br>G1/2 for VTUS 25<br>G3/4 for VTUS 30  | [4] Thread for extension module:<br>M5x15.5 for VTUS 20<br>M5x18 for VTUS 25<br>M5x18 for VTUS 30 | [6] Profile slot IPM-05, system 5   | [9] Supply plate, ports 1 and 3:<br>G1/8 for VTUS 20<br>G1/4 for VTUS 25<br>G3/8 for VTUS 30 |
| [3] Port 12 on the manifold block at both ends: G1/8<br>Port 10 and 12 on the valve:<br>M5 for VTUS 20,<br>M5 for VTUS 25,<br>G1/8 for VTUS 30 | [5] Port 2:<br>G1/8 for VTUS 20<br>G1/4 for VTUS 25<br>G3/8 for VTUS 30                           | [7] H-rail mounting VAME-T-M4 for VTUS 20<br>VAME-T-M5 for VTUS 25<br>VAME-T-M6 for VTUS 30 | [10] 3/2-way valve   |
|  |   | [8] Blanking plate  |  |

 **Note**

Port 12 on the manifold rail (number 3 in the dimensional drawing) is not used when equipped with pneumatic valves.

Data sheet

Type	B3	B4	B5	B6	B7	B8	B9	B11	B12	B14	B15	B16
VTUS-20	77	75.5	53	66.5	63	50	24	12.5	41.2	11.5	25	5.5
VTUS-25	92	93	67.5	80.5	78	62	30	16	–	14	32	6
VTUS-30	109.2	108.2	79	93.2	94.7	75.7	36.2	19	55.5	17.2	38	6.5

Type	D1 ø	D2	H1	H2	H3	H4	H5	H6	H7	H8	H9	L3	L4	L5	L6
VTUS-20	4.5	M4x6.5	77.4	61	37	23.5	8.5	18	5	91.4	32	6	25	22	1
VTUS-25	5.5	M4x9	95.5	71	45	25	9	22	5	123.4	39	6	29.8	27.5	1
VTUS-30	6.3	M5x11	118	91	61	35	9	28.5	6.5	170.1	54.5	7.2	34	32	–

Valve positions	2	3	4	5	6	7	8	9	10	
VTUS-20	L1 [mm]	72	94	116	138	160	182	204	226	248
	L2 [mm]	60	82	104	126	148	170	192	214	236
VTUS-25	L1 [mm]	87	114.5	142	169.5	197	224.5	252	279.5	307
	L2 [mm]	75	102.5	130	157.5	185	212.5	240	267.5	295
VTUS-30	L1 [mm]	100	132	164	196	228	260	292	324	356
	L2 [mm]	85	117	149	181	213	245	277	309	341



Data sheet – Valve manifold assembly

Dimensions – Valve manifold assembly

Download CAD data → [www.festo.com](http://www.festo.com)

With 3/2-way valves, compact manifold rail

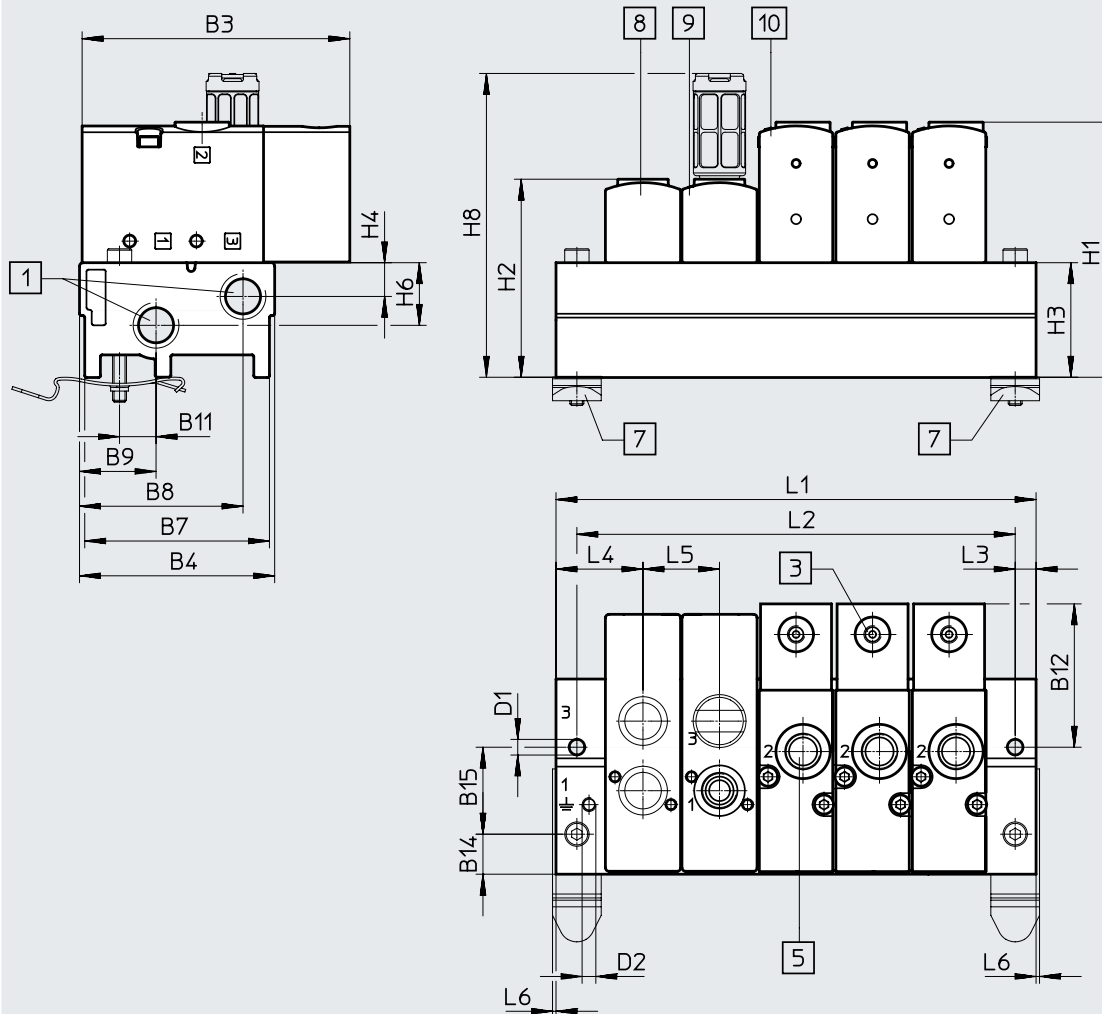

- |   |   |  |                    |
|---|---|--|--------------------|
| [1] Ports 1 and 3 (at both ends):<br>G1/4 for VTUS 20<br>G3/8 for VTUS 25<br>G1/2 for VTUS 30 | [5] Port 2:<br>G1/8 for VTUS 20<br>G1/4 for VTUS 25<br>G3/8 for VTUS 30                     | [8] Blanking plate   | [10] 3/2-way valve |
| [3] Ports 10 and 12 on the valve:<br>M5 for VTUS 20<br>M5 for VTUS 25<br>G1/8 for VTUS 30     | [7] H-rail mounting VAME-T-M4 for VTUS 20<br>VAME-T-M5 for VTUS 25<br>VAME-T-M6 for VTUS 30 | [9] Supply plate, ports 1 and 3:<br>G1/8 for VTUS 20<br>G1/4 for VTUS 25<br>G3/8 for VTUS 30 |                    |

Data sheet – Valve manifold assembly

Type	B3	B4	B7	B8	B9	B11	B12	B14	B15
VTUS-20	77	56.1	53.1	47	22	10.5	41.2	11.5	25
VTUS-25	92	70.3	67.3	58.8	30	16	47	14	32
VTUS-30	109.2	83	80	69.4	36	19	55.5	17	38

Type	D1 ø	D2	H1	H2	H3	H4	H6	H8	L3	L4	L5	L6
VTUS-20	4.5	M4x6.5	73.4	57	33	9.7	18	87.4	6	25	22	1
VTUS-25	5.5	M4x9	84.5	60	34	13.5	20	112.4	6	29.8	27.5	1
VTUS-30	6.3	M5x11	99.5	72.5	42.5	17.5	26	151.6	7.5	38	32	–

Valve positions		2	3	4	5	6	7	8	9	10
VTUS-20	L1 [mm]	72	94	116	138	160	182	204	226	248
	L2 [mm]	60	82	104	126	148	170	192	214	236
VTUS-25	L1 [mm]	87	114.5	142	169.5	197	224.5	252	279.5	307
	L2 [mm]	75	102.5	130	157.5	185	212.5	240	267.5	295
VTUS-30	L1 [mm]	100	132	164	196	228	260	292	324	356
	L2 [mm]	85	117	149	181	213	245	277	309	341

## Data sheet – Valve manifold assembly

### Dimensions – Valve manifold assembly

Download CAD data → [www.festo.com](http://www.festo.com)

With 5/2-, 5/3-way and 2x 3/2-way valves, standard manifold rail

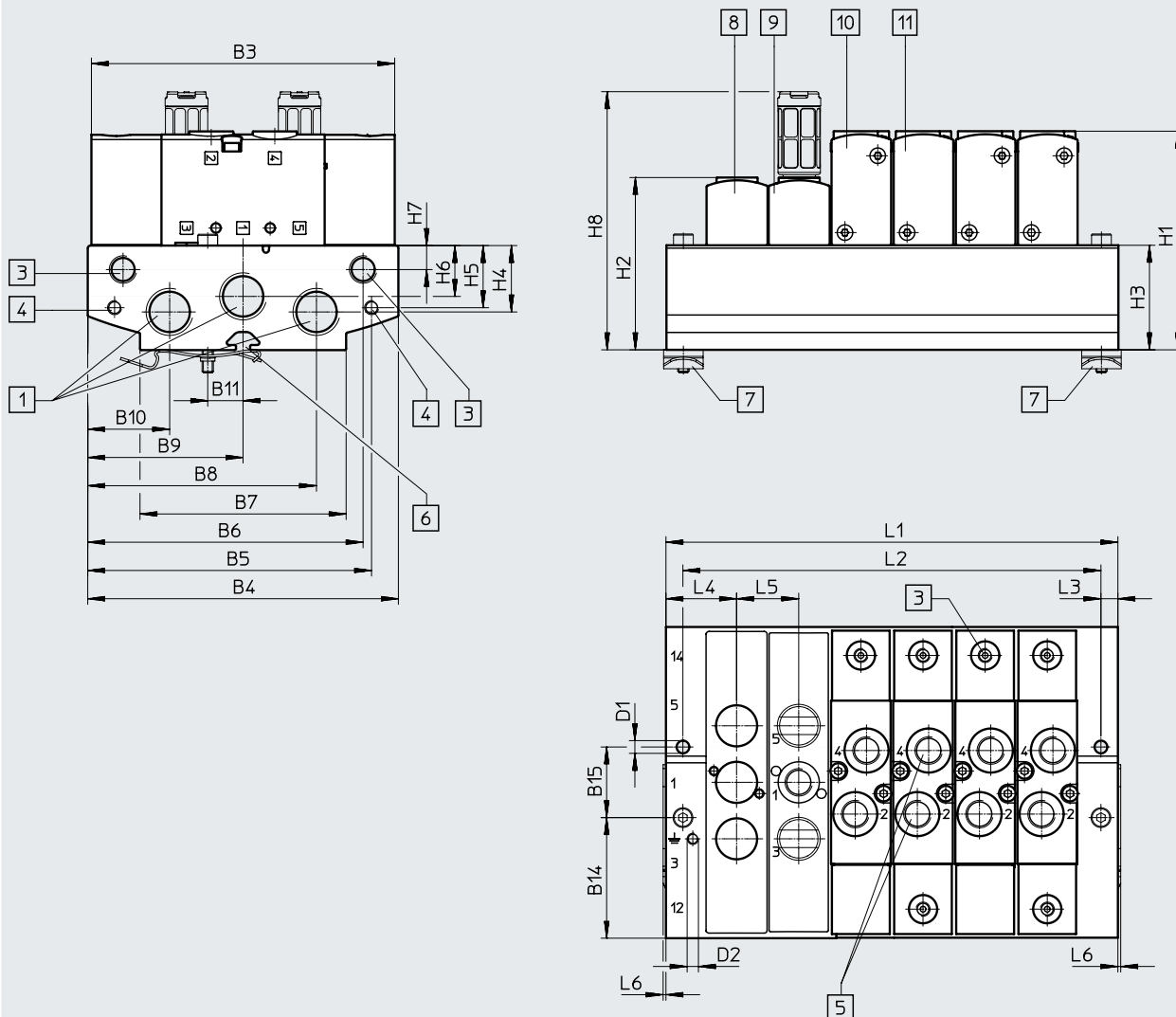

- |   |   |   |   |
|---|---|---|---|
| [1] Ports 1, 3 and 5 (at both ends):<br>G3/8 for VTUS 20<br>G1/2 for VTUS 25<br>G3/4 for VTUS 30  | [4] Thread for extension module:<br>M5x15.5 for VTUS 20<br>M5x18 for VTUS 25<br>M5x18 for VTUS 30 | [6] Profile slot IPM-05, system 5   | [9] Supply plate. Ports 1, 3 and 5:<br>G1/8 for VTUS 20<br>G1/4 for VTUS 25<br>G3/8 for VTUS 30   |
| [3] Port 12 and 14 on the manifold block at both ends: G1/8<br>Port 10 and 12 on the valve:<br>M5 for VTUS 20,<br>M5 for VTUS 25,<br>G1/8 for VTUS 30 | [5] Ports 2 and 4: G1/8 for VTUS 20<br>G1/4 for VTUS 25<br>G3/8 for VTUS 30                       | [7] H-rail mounting VAME-T-M4 for VTUS 20<br>VAME-T-M5 for VTUS 25<br>VAME-T-M6 for VTUS 30 | [10] 5/2-way monostable valve<br>[11] 5/2-way bistable valve or 5/3-way valve or 2x 3/2-way valve |
|   |   | [8] Blanking plate  |   |

### Note

Port 12 on the manifold rail (number 3 in the dimensional drawing) is not used when equipped with pneumatic valves.

Data sheet – Valve manifold assembly

Type	B3	B4	B5	B6	B7	B8	B9	B10	B11	B14	B15
VTUS-20	107.4	110	100.5	97.5	73	81	55	29	12.5	42.5	25
VTUS-25	126	126	119	113.5	80	95	63	31	16	47	32
VTUS-30	149	144	137	129	104	111.5	72	32.5	19	53	38

Type	D1 ø	D2	H1	H2	H3	H4	H5	H6	H7	H8	L3	L4	L5	L6
VTUS-20	4.5	M4x6.5	77.4	61	37	23.5	22	18	8.5	91.4	6	25	22	1
VTUS-25	5.5	M4x9	95.5	71	45	25	22	22	9	123.4	6	29.8	27.5	1
VTUS-30	6.3	M5x11	118	91	61	35	22	28.5	9	170.1	7.5	34	32	–

Valve positions		2	3	4	5	6	7	8	9	10
VTUS-20	L1 [mm]	72	94	116	138	160	182	204	226	248
	L2 [mm]	60	82	104	126	148	170	192	214	236
VTUS-25	L1 [mm]	87	114.5	142	169.5	197	224.5	252	279.5	307
	L2 [mm]	75	102.5	130	157.5	185	212.5	240	267.5	295
VTUS-30	L1 [mm]	100	132	164	196	228	260	292	324	356
	L2 [mm]	85	117	149	181	213	245	277	309	341

Data sheet – Valve manifold assembly

Dimensions – Valve manifold assembly

Download CAD data → [www.festo.com](http://www.festo.com)

With 5/2-, 5/3-way and 2x 3/2-way valves, compact manifold rail

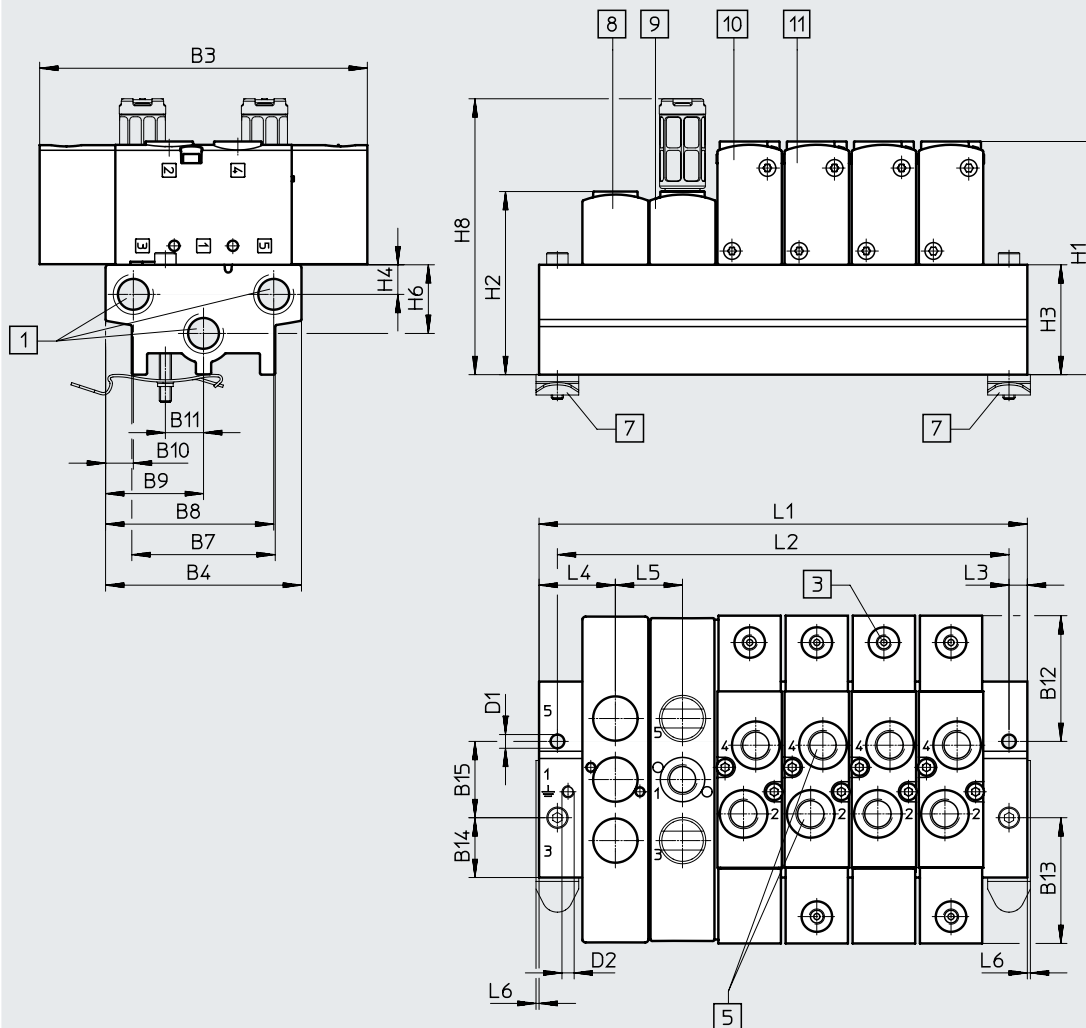

- |   |   |   |  |
|---|---|---|--|
| <p>[1] Ports 1, 3 and 5 (at both ends):<br/>G1/4 for VTUS 20<br/>G3/8 for VTUS 25<br/>G1/2 for VTUS 30</p> <p>[3] Port 12 and 14 on the valve:<br/>M5 for VTUS 20,<br/>M5 for VTUS 25,<br/>G1/8 for VTUS 30</p> | <p>[5] Ports 2 and 4: G1/8 for VTUS 20<br/>G1/4 for VTUS 25<br/>G3/8 for VTUS 30</p> <p>[7] H-rail mounting VAME-T-M4 for VTUS 20<br/>VAME-T-M5 for VTUS 25<br/>VAME-T-M6 for VTUS 30</p> | <p>[8] Blanking plate</p> <p>[9] Supply plate, ports 1, 3 and 5:<br/>G1/8 for VTUS 20<br/>G1/4 for VTUS 25<br/>G3/8 for VTUS 30</p> | <p>[10] 5/2-way monostable valve</p> <p>[11] 5/2-way bistable valve or 5/3-way valve or 2x 3/2-way valve</p> |
|---|---|---|--|

Data sheet – Valve manifold assembly

Type	B3	B4	B7	B8	B9	B10	B11	B12	B13	B14	B15
VTUS-20	107.4	64.2	47	55.1	32.1	9.1	12.5	41.2	41.2	19.6	25
VTUS-25	126	80.5	61.5	69	40.3	11.5	16	47	47	24.3	32
VTUS-30	149	94	77	80.4	47	13.6	19	55.5	55.5	28	38

Type	D1 ø	D2	H1	H2	H3	H4	H6	H8	L3	L4	L5	L6
VTUS-20	4.5	M4x6.5	76.4	60	36	9.7	22.5	90.4	6	25	22	1
VTUS-25	5.5	M4x9	84.5	60	34	13.5	20	112.1	6	29.8	27.5	1
VTUS-30	6.3	M5x11	99.5	72.5	42.5	17.5	26	151.6	7.5	34	32	–

Valve positions		2	3	4	5	6	7	8	9	10
VTUS-20	L1 [mm]	72	94	116	138	160	182	204	226	248
	L2 [mm]	60	82	104	126	148	170	192	214	236
VTUS-25	L1 [mm]	87	114.5	142	169.5	197	224.5	252	279.5	307
	L2 [mm]	75	102.5	130	157.5	185	212.5	240	267.5	295
VTUS-30	L1 [mm]	100	132	164	196	228	260	292	324	356
	L2 [mm]	85	117	149	181	213	245	277	309	341

Data sheet – Valve manifold assembly

Dimensions – Common supply manifold

Download CAD data → [www.festo.com](http://www.festo.com)

Mounting on both sides

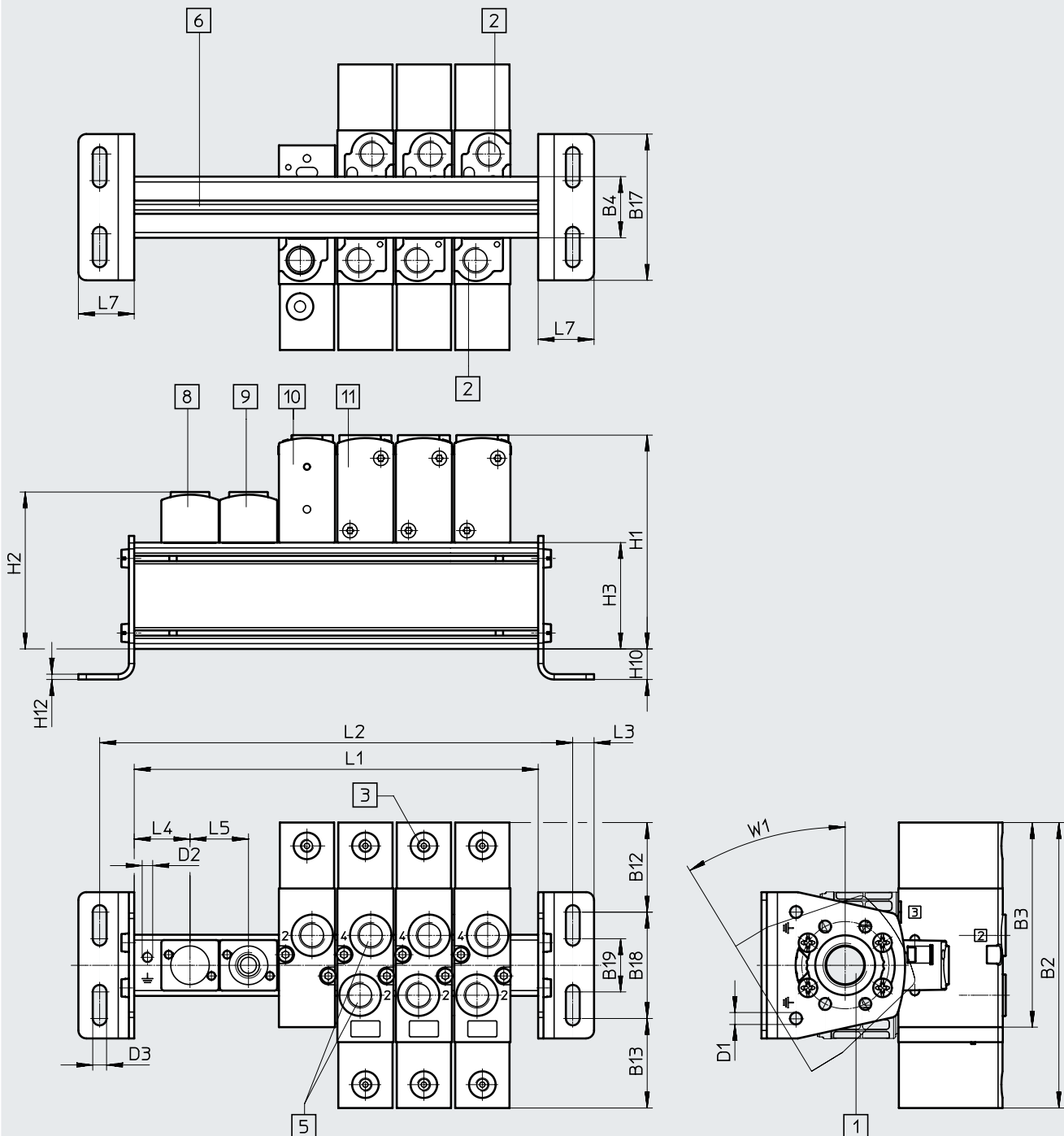

[1] Port 1 (at both ends):

- G3/8 for VTUS 20
- G1/2 for VTUS 25
- G3/4 for VTUS 30

[2] Ports 3 and 5: G1/8 for VTUS 20

- G1/4 for VTUS 25
- G3/8 for VTUS 30

[3] Port 12 and 14 on the valve:

- M5 for VTUS 20,
- M5 for VTUS 25,
- G1/8 for VTUS 30

[5] Ports 2 and 4:

- G1/8 for VTUS 20
- G1/4 for VTUS 25
- G3/8 for VTUS 30

[6] Profile slot IPM-05, system 5

[8] Blanking plate

- [9] Supply plate, port 1:
- G1/8 for VTUS 20
- G1/4 for VTUS 25
- G3/8 for VTUS 30

[10] 3/2-way valve

[11] 5/2-way bistable valve or 5/3-way valve or 2x 3/2-way valve

 **Note**

Mounting bracket can be adjusted through  $\pm 30^\circ$

Data sheet – Valve manifold assembly

Type	B2	B3	B4	B12	B13	B17	B18	B19	H1	H2	H3
VTUS-20	107.4	77	23	33.7	33.7	55	40	20	80.4	59	40
VTUS-25	126	92	28.7	33	33	75	60	35	102.5	78	52
VTUS-30	149	109.2	34	42	42	85	65	35	122	95	65

Type	H10	H12	D1 ø	D2	D3 ø	L3	L4	L5	L7	W1
VTUS-20	11.5	2	4.5	M4x6.5	5.2	9	21	22	22	31.3°
VTUS-25	18	2	4.5	M4x9	6.6	8	29.8	27.5	24	30°
VTUS-30	17.5	2.5	5.5	M5x11	8.6	9	34	32	26	28°

Valve positions		2	3	4	5	6	7	8	9	10
VTUS-20	L1 [mm]	64	86	108	130	152	174	196	218	240
	L2 [mm]	90	112	134	156	178	200	222	244	266
VTUS-25	L1 [mm]	87	114.5	142	169.5	197	224.5	252	279.5	307
	L2 [mm]	119	156.5	174	201.5	229	256.5	284	311.5	339
VTUS-30	L1 [mm]	100	132	164	196	228	260	292	324	356
	L2 [mm]	134	166	198	230	262	294	326	358	390



Data sheet – Valve manifold assembly

Dimensions – Common supply manifold

Download CAD data → [www.festo.com](http://www.festo.com)

Mounting on one side

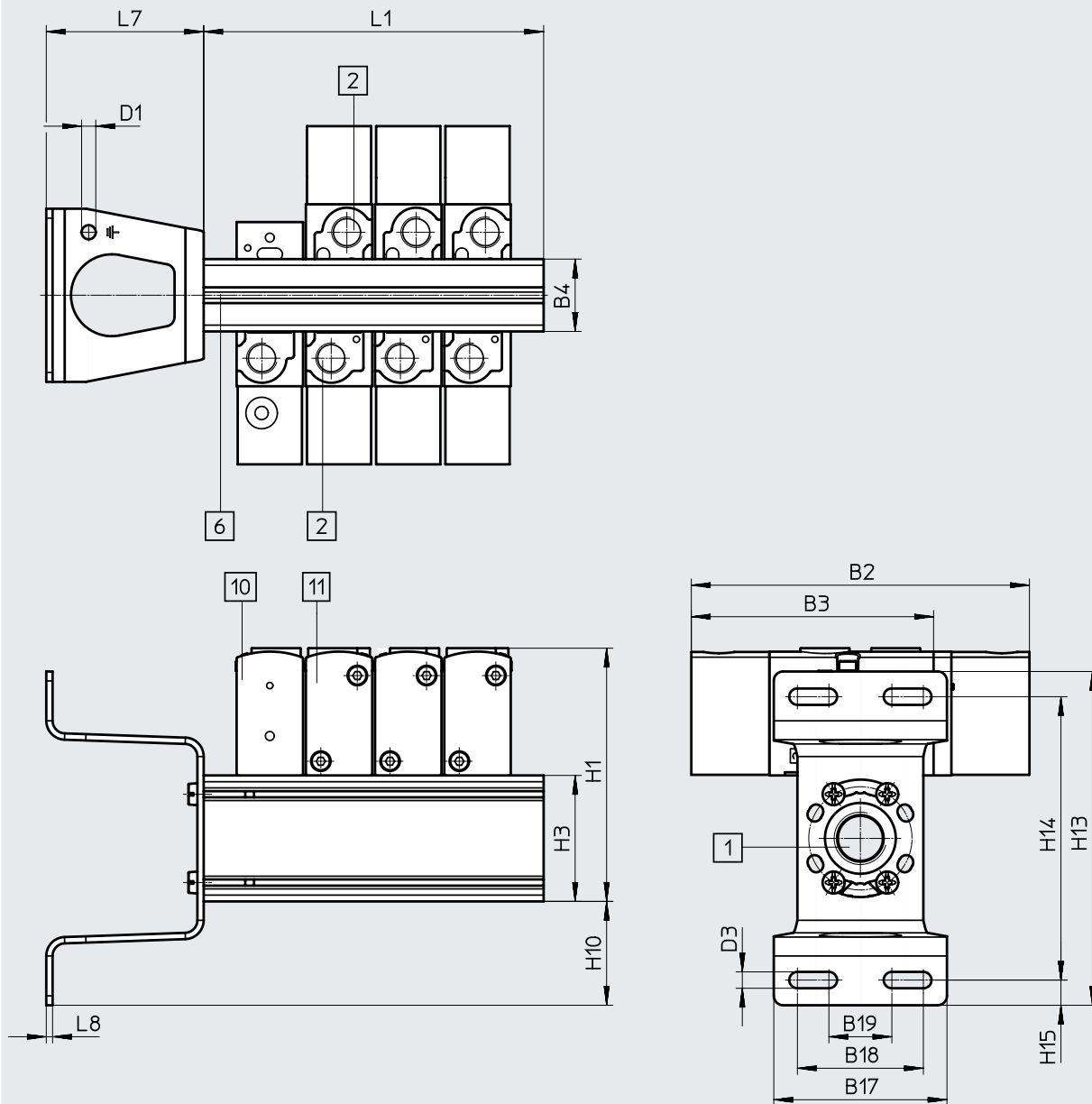

[1] Port 1 (at both ends):  
 G3/8 for VTUS 20  
 G1/2 for VTUS 25  
 G3/4 for VTUS 30

[2] Ports 3 and 5:  
 G1/8 for VTUS 20  
 G1/4 for VTUS 25  
 G3/8 for VTUS 30  
 [6] Profile slot IPM-05, system 5

[10] 3/2-way valve  
 [11] 5/2-way bistable valve or 5/3-way valve or 2x 3/2-way valve

 **Note**  
 Mounting bracket can be adjusted through ±30°

Data sheet – Valve manifold assembly

Type	B2	B3	B4	B17	B18	B19
VTUS-20	107.4	77	23	55	40	20
VTUS-25	126	92	28.7	80	60	35
VTUS-30	149	109.2	34	85	65	35

Type	D1 ø	D3 ø	H1	H3	H10	H13	H14	H15	L7	L8
VTUS-20	4.5	5.2	80.4	40	33	107	89	8	50	2
VTUS-25	4.5	6.6	102.5	52	38	128	112	8	64	2
VTUS-30	5.5	8.6	122	65	38	146	128	9	74	2.5

Valve positions	2	3	4
VTUS-20 L1 [mm]	64	86	108
VTUS-25 L1 [mm]	87	114.5	142
VTUS-30	100	132	164

## Type codes – Pneumatic valves

001	Series	
VUWS	Pneumatic valve	
002	Directional control valve type	
L	In-line valve	
003	Design principle	
	Piston spool	
T	Poppet valve	
004	Size	
20	Size 20	
25	Size 25	
30	Size 30	
005	Valve function	
M32U	3/2-way valve, normally open	
M32C	3/2-way valve, normally closed	
T32U	2x3/2-way valve, normally open	
T32C	2x3/2-way valve, normally closed	
T32H	2x3/2-way valve, 1x normally closed, 1x normally open	
M52	5/2-way valve, monostable	
B52	5/2-way valve, bistable	
P53U	5/3-way valve, mid-position pressurised	
P53E	5/3-way valve, mid-position exhausted	
P53C	5/3-way valve, mid-position closed	

006	Reset method for monostable valves	
	None	
A	Pneumatic spring	
E	Pneumatic spring, external	
M	Mechanical spring	
007	Pneumatic connection	
G18	G1/8	
G14	G1/4	
G38	G3/8	
G12	G1/2	
N18	1/8 NPT	
N14	1/4 NPT	
N38	3/8 NPT	
Q4	Push-in connector 4 mm	
Q6	Push-in connector 6 mm	
Q8	Push-in connector 8 mm	
Q10	Push-in connector 10 mm	
Q12	Push-in connector 12 mm	
T532	Push-in connector 5/32"	
T14	Push-in connector 1/4"	
T38	Push-in connector 3/8"	
T516	Push-in connector 5/16"	
T12	Push-in connector 1/2"	
008	Exhaust	
	No fitting	
QN	With fitting	
U	Silencer	

## Data sheet

-  - Flow rate  
up to 600 l/min

-  - Valve width  
21 mm

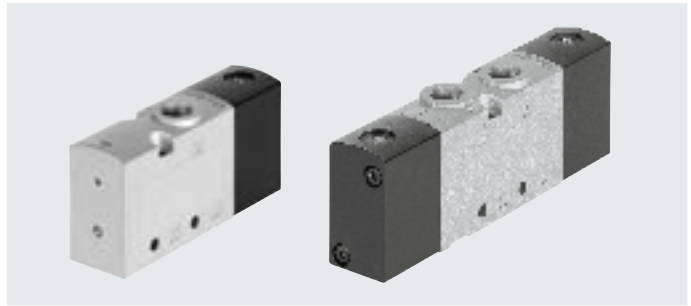

General technical data		3/2-way valve		2x 3/2-way valve			5/2-way valve	
Valve function								
Order code for valves		M32C	M32U	T32C	T32U	T32H	M52	B52
Valve width	[mm]	21						
Design		Poppet seat						
Pneumatic spring supply		Internal						
Type of control		Direct						
Manual override (MO)		None						
Flow direction		Non-reversible						
Overlap		Negative overlap						
Sealing principle		Soft						
Type of mounting		Optionally via through-holes <sup>1)</sup> or on manifold rail						
Standard nominal flow rate qnN	[l/min]	600	600	600	600	600	500	500
Through-holes (nominal width)	[mm]	5.2	5.2	5.2	5.2	5.2	5	5
Product weight	[g]	117	119	189	191	190	173	192
Type of actuation		Pneumatic						
Mounting position		Any						
Exhaust function		Can be throttled						
Venting hole		Not ducted						
Pneumatic connection	1, 2, 3 4, 5	G1/8	G1/8	G1/8	G1/8	G1/8	G1/8	G1/8
Pneumatic spring connection	12/14, 10	M5						

1) If several valves are to be screwed together via through-holes to form a block, a minimum distance of 0.3 mm must be ensured by placing spacer discs between them.

## Data sheet

Technical data – 3/2-way valves		
Order code for valves	M32C	M32U
Normal position	Closed	Open
Stable position	Monostable	Monostable
Reset method	Mechanical spring	Mechanical spring
Switching times in [ms]	On	6
	Off	19
	Change-over	–

Technical data – 5/2-way valves		
Order code for valves	M52	B52
Stable position	Monostable	Bistable
Reset method	Mechanical spring	–
Switching times in [ms]	On	10
	Off	14
	Change-over	–

Technical data – 2x 3/2-way valves				
Order code for valves	T32C	T32U	T32H	
Stable position	Monostable			
Reset method	Mechanical spring			
Switching times in [ms]	On	6	6	6
	Off	19	18	19

Safety characteristics	
Shock resistance	Shock test with severity level 2 to FN 942017-5 and EN 60068-2-27
Vibration resistance	Transport application test with severity level 2 to FN 942017-4 and EN 60068-2-6

Operating and environmental conditions					
Valve function	M32	M52	B52	T32	
Operating medium	Compressed air to ISO 8573-1:2010 [7:4:4]				
Pilot medium	Compressed air to ISO 8573-1:2010 [7:4:4]				
Note on the operating/pilot medium	Lubricated operation possible (in which case lubricated operation will always be required)				
Operating pressure	[MPa]	–0.09 ... +1	0.25 ... 1	0.15 ... 1	–0.09 ... +1
	[bar]	–0.9 ... +10	2.5 ... 10	1.5 ... 10	–0.9 ... +10
Pilot pressure	[MPa]	0.15 ... 1	0.25 ... 1	0.15 ... 1	0.15 ... 1
	[bar]	1.5 ... 10	2.5 ... 10	1.5 ... 10	1.5 ... 10
Ambient temperature	[°C]	–5 ... +60			
Temperature of medium	[°C]	–5 ... +60			
Certification	cUL us - Recognized (OL)				
Corrosion resistance class CRC <sup>1)</sup>	2				

1) More information: [www.festo.com/x/topic/kbk](http://www.festo.com/x/topic/kbk)

Information on materials	
Housing	Die-cast aluminium (painted)
Seals	HNBR, NBR, TPE-U(PU)
Screws	Galvanised steel
Note on materials	RoHS-compliant

Data sheet

Dimensions

Download CAD data → [www.festo.com](http://www.festo.com)

3/2-way valve

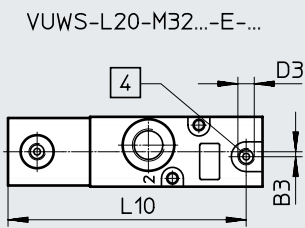
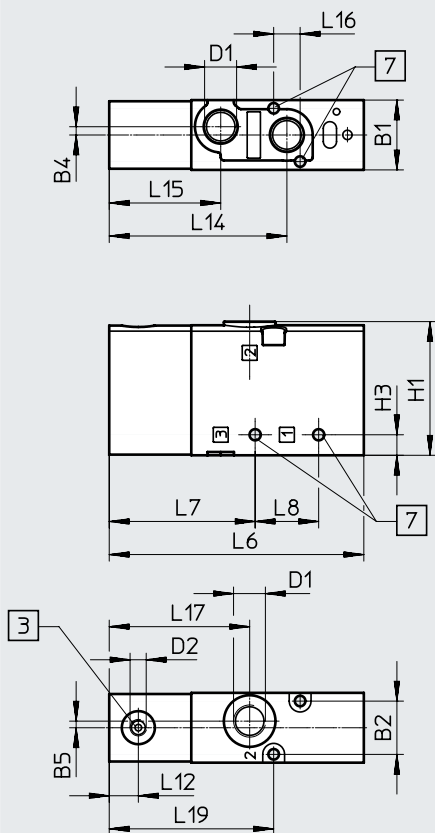

- [3] Port 10 for pilot air (VUWS-LT20-M32U)  
Port 12 for pilot air (VUWS-LT20-M32C)
- [7] For retaining screw M3

Type	B1	B2	B4	B5	D1	D2	H1	H3
VUWS-LT20-M32...-G18	21.1	16.1	2.5	2	G1/8	M5	40.4	6.2

Type	L6	L7	L8	L12	L14	L15	L16	L17	L19
VUWS-LT20-M32...-G18	77	44.1	19.2	8.8	53.7	33.7	8	42.5	49.7

Data sheet

Dimensions

Download CAD data → [www.festo.com](http://www.festo.com)

5/2-way valve, monostable

VUWS-L20-M52-E-G18

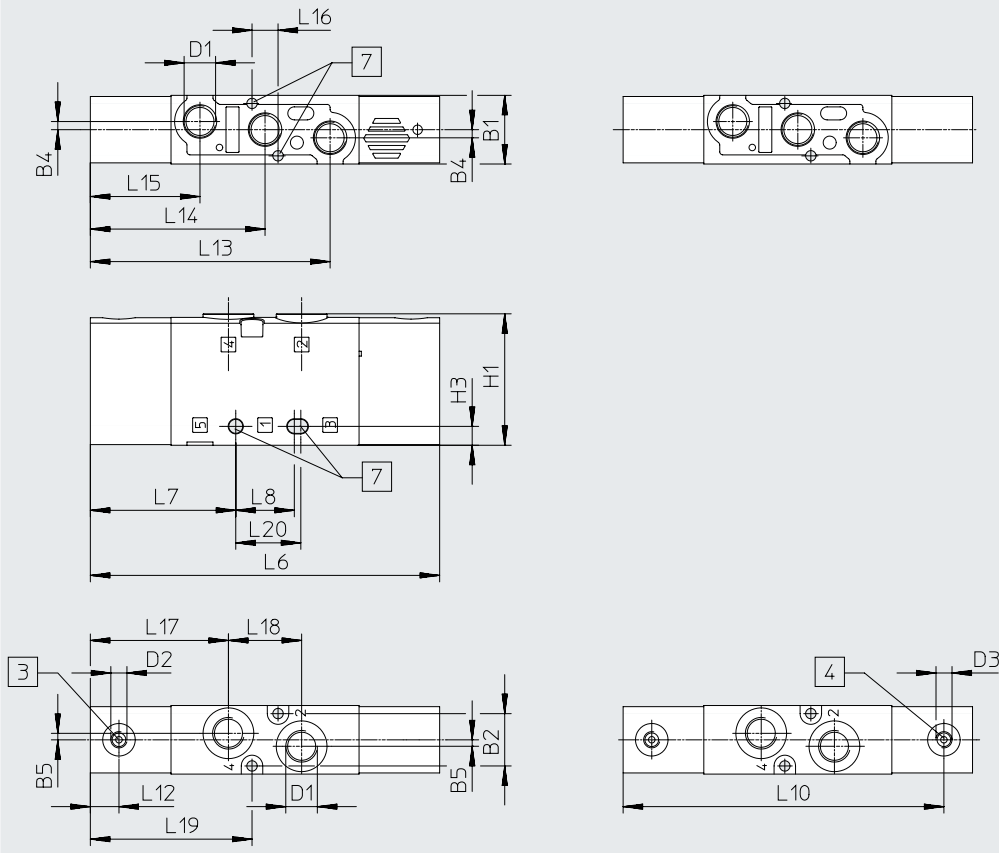

- [3] Port 14: pilot air
- [4] Port 12: pilot air
- [7] For retaining screw M4

Type	B1	B2	B4	B5	D1	D2	D3	H1	H3	L6
VUWS-LT20-M52-M...-G18	21.1	16.1	2.5	2	G1/8	M5	-	40.4	5.8	107.4

Type	L10	L7	L8	L12	L13	L14	L15	L16	L17	L18	L19	L20
VUWS-LT20-M52-M...-G18	-	44.7	18	8.8	73.7	53.7	33.7	8	42.5	22.5	49.7	20

Data sheet

Dimensions

Download CAD data → [www.festo.com](http://www.festo.com)

2x 3/2-way valve and 5/2-way valve, bistable

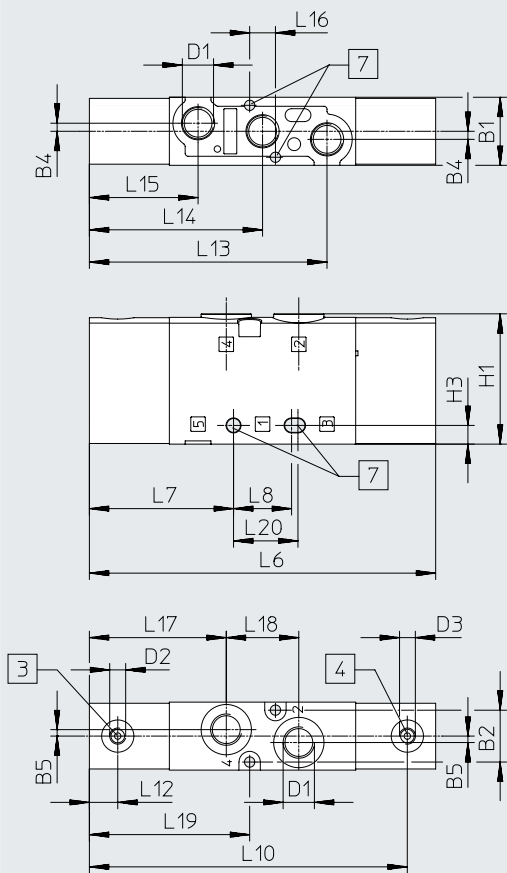

- [3] Port 14: pilot air
- [4] Port 12: pilot air
- [7] For retaining screw M4

Type	B1	B2	B4	B5	D1	D2	D3	H1	H3
VUWS-LT20-T32-...-M-G18	21.1	16.1	2.5	2	G1/8	M5	M5	40.4	5.8
VUWS-LT20-B52-G18									

Type	L6	L7	L8	L10	L12	L13	L14	L15	L16	L17	L18	L19	L20
VUWS-L20-T32-...-M-G18	107.4	44.7	18	98.6	8.8	73.7	53.7	33.7	8	42.5	22.5	49.7	20
VUWS-LT20-B52-G18													



Data sheet

Dimensions

Foot mounting

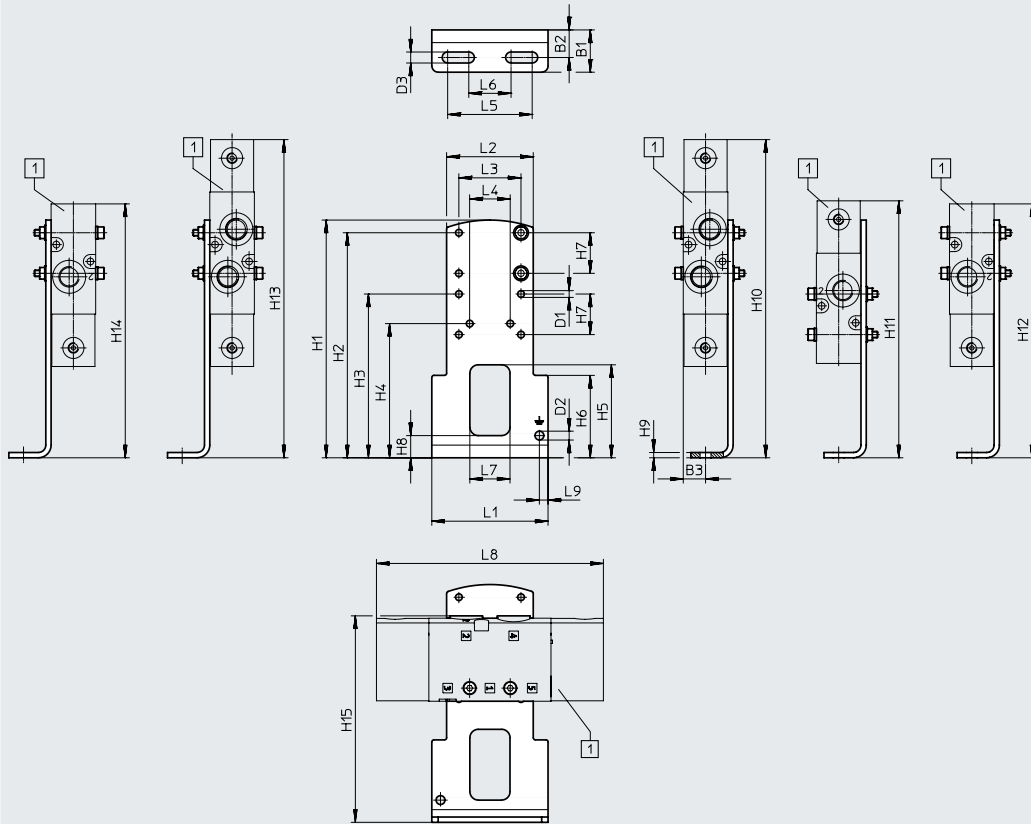

[1] VUWS-LT20-B52/T32,  
 VUWS-LT20-M52,  
 VUWS-LT20-M32

Type		B1	B2	B3	D1 ∅	D2 ∅	D3 ∅	H1	H2	H3	H4
VAME-B10-20-A	VUWS-LT20-B52/T32	20	13.1	10.6	3.2	4.2	5.2	112.5	106.5	77.5	63.5
	VUWS-LT20-M52										
	VUWS-LT20-M32										

Type		H5	H6	H7	H8	H9	H10	H11	H12	H13	H14
VAME-B10-20-A	VUWS-LT20-B52/T32	44	39	19.2	10.5	2.5	150.6	121.6	150.6	150.6	150.6
	VUWS-LT20-M52								120.2		
	VUWS-LT20-M32										

Type		H15	L1	L2	L3	L4	L5	L6	L7	L8	L9
VAME-B10-20-A	VUWS-LT20-B52/T32	97.7	55	41	29.4	19.2	40	20	19	107.4	4.1
	VUWS-LT20-M52									77	
	VUWS-LT20-M32										

Data sheet

Dimensions

Wall mounting

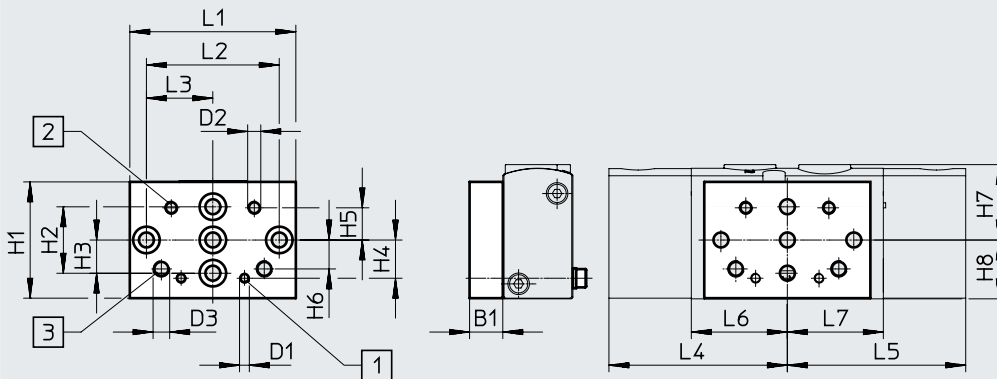

[1] Mounting hole for size 20

[2] Mounting hole for size 25

[3] Mounting hole for size 30



Type		B1	D1	D2	D3	H1	H2	H3	H4	H5	H6
VAME-B10-20-W	VUWS-LT20-B52/T32	10	M3	M4	M5	35	20	10	11.5	9.7	8.7
	VUWS-LT20-M52										
	VUWS-LT20-M32										

Type		H7	H8	L1	L2	L3	L4	L5	L6	L7
VAME-B10-20-W	VUWS-LT20-B52/T32	22.7	17.7	50	40	20	53.7	53.7	28.9	28.9
	VUWS-LT20-M52									
	VUWS-LT20-M32									

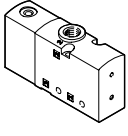
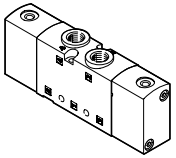
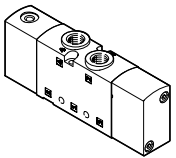
## Ordering data – Pneumatic valves, size 20

Ordering data				
	Code	Valve function	Part no.	Type
<b>3/2-way valve</b>				
	<b>Normally closed, monostable</b>			
	M32C	Reset via mechanical spring, internal pilot air supply, flow direction not reversible	577525	VUWS-LT20-M32C-M-G18
	<b>Normally open, monostable</b>			
	M32U	Reset via pneumatic spring, internal pilot air supply, flow direction not reversible	577526	VUWS-LT20-M32U-M-G18
<b>2x 3/2-way valve</b>				
	<b>Monostable, normally closed</b>			
	T32C	Reset via mechanical spring, internal pilot air supply, flow direction not reversible	577529	VUWS-LT20-T32C-M-G18
	<b>Monostable, normally open</b>			
	T32H	Reset via mechanical spring, internal pilot air supply, flow direction not reversible	577531	VUWS-LT20-T32H-M-G18
<b>Monostable, 1x normally open, 1x normally closed</b>				
T32U	Reset via mechanical spring, internal pilot air supply, flow direction not reversible	577530	VUWS-LT20-T32U-M-G18	
<b>5/2-way valve</b>				
	<b>Monostable</b>			
	M52-M	Reset via mechanical spring, internal pilot air supply, flow direction not reversible	577527	VUWS-LT20-M52-M-G18
	<b>Bistable</b>			
B52	Internal pilot air supply, flow direction not reversible	577528	VUWS-LT20-B52-G18	

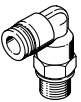
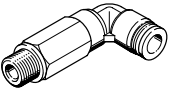
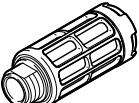
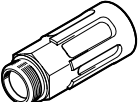
## Accessories

Ordering data		Description	Part no.	Type	PU <sup>1)</sup>
<b>Push-in fitting with internal hex</b>					
	Connecting thread M5 for tubing O.D.	4 mm	153315	QSM-M5-4-I	10
	Connecting thread G1/8 for tubing O.D.	4 mm	186106	QS-G1/8-4-I	10
		4 mm	133008	QS-G1/8-4-I-100	100
		6 mm	186107	QS-G1/8-6-I	10
			133009	QS-G1/8-6-I-100	100
		8 mm	186109	QS-G1/8-8-I	10
			133010	QS-G1/8-8-I-100	100
<b>Angled push-in fitting with external hex</b>					
	Connecting thread G1/8 for tubing O.D.	4 mm	186116	QSL-G1/8-4	10
			132048	QSL-G1/8-4-100	100
		6 mm	186117	QSL-G1/8-6	10
			132049	QSL-G1/8-6-100	100
		8 mm	186119	QSL-G1/8-8	10
			132050	QSL-G1/8-8-50	50
<b>Angled push-in fitting, long, with external hex</b>					
	Connecting thread G1/8 for tubing O.D.	4 mm	186127	QSL-G1/8-4	10
			133015	QSL-G1/8-4-100	100
		6 mm	186128	QSL-G1/8-6	10
			133016	QSL-G1/8-6-100	100
		8 mm	186130	QSL-G1/8-8	10
			133017	QSL-G1/8-8-100	100
<b>Silencer</b>					
	With connecting thread G, polymer design	G1/8	2307	U-1/8	1
			534222	U-1/8-50	50
	With connecting thread G, metal design	G1/8	6841	U-1/8-B	1
	With connecting thread G, sintered design, long	G1/8	1205860	AMTE-M-LH-G18	20

1) Packaging unit

## Accessories

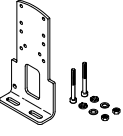
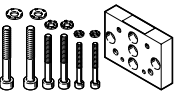
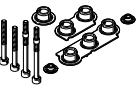
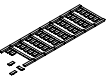
Ordering data	Description	Weight [g]	Part no.	Type
<b>Foot mounting</b>				
	Set for mounting valves, comprising: <ul style="list-style-type: none"> <li>• Mounting bracket and</li> <li>• Screw set for mounting</li> </ul>	97	576412	VAME-B10-20-A
<b>Wall mounting</b>				
	Set for mounting valves for size 20, 25, 30, comprising: <ul style="list-style-type: none"> <li>• Wall mounting and</li> <li>• Screw set for mounting</li> </ul>	53	576413	VAME-B10-20-W
<b>Assortment of spare parts</b>				
	Set comprising: <ul style="list-style-type: none"> <li>• Seals and</li> <li>• Screws</li> </ul>	10	8026203	VAME-B10-20-MK
<b>Inscription label</b>				
	40 pieces in frame	-	565306	ASLR-C-E4

Data sheet

-  - Flow rate  
up to 1000 l/min

-  - Valve width  
26.5 mm

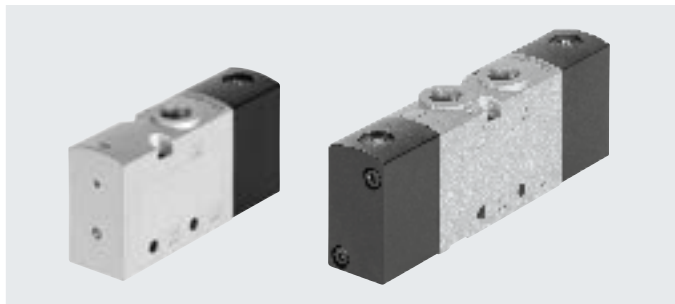

General technical data		3/2-way valve		2x 3/2-way valve			5/2-way valve	
Valve function								
Order code for valves		M32C	M32U	T32C	T32U	T32H	M52	B52
Valve width	[mm]	26.5						
Design		Poppet seat						
Type of control		Direct						
Manual override (MO)		None						
Flow direction		Non-reversible						
Overlap		Negative overlap						
Sealing principle		Soft						
Type of mounting		Optionally via through-holes or on manifold rail						
Standard nominal flow rate qnN	[l/min]	1000						
Through-holes (nominal width)	[mm]	6.9	6.6	6.9	6.9	6.9	6.6	6.6
Product weight	[g]	221	255	343	411	377	317	344
Type of actuation		Pneumatic						
Mounting position		Any						
Exhaust function		Can be throttled						
Port for venting hole		Not ducted						
Pneumatic connection	1, 2, 3 4, 5	G1/4 -	G1/4 -	G1/4 G1/4	G1/4 G1/4	G1/4 G1/4	G1/4 G1/4	G1/4 G1/4
Pneumatic spring connection	12/14, 10	M5						

Technical data – 3/2-way valves		M32C	M32U	T32C	T32U	T32H
Order code for valves						
Normal position		Closed	Open	Closed	Open	1x open, 1x closed
Stable position		Monostable				
Reset method		Mechanical spring				
Switching times in [ms]	On	6	7	6	7	7
	Off	29	30	29	30	30

## Data sheet

Technical data – 5/2-way valves		
Order code for valves	M52	B52
Stable position	Monostable	Bistable
Reset method	Mechanical spring	–
Switching times in [ms]	On	8
	Off	23
	Change-over	–
		6

Safety characteristics	
Shock resistance	Shock test with severity level 2 to FN 942017-5 and EN 60068-2-27
Vibration resistance	Transport application test with severity level 2 to FN 942017-4 and EN 60068-2-6

Operating and environmental conditions					
Order code for valves	M32	T32	M52	B52	
Operating medium	Compressed air to ISO 8573-1:2010 [7:4:4]				
Pilot medium	Compressed air to ISO 8573-1:2010 [7:4:4]				
Note on the operating/pilot medium	Lubricated operation possible (in which case lubricated operation will always be required)				
Operating pressure	[MPa]	–0.09 ... 1	–0.09 ... 1	0.25 ... 1	0.15 ... 1
	[bar]	–0.9 ... 10	–0.9 ... 10	2.5 ... 10	1.5 ... 10
Pilot pressure	[MPa]	0.25 ... 1	0.25 ... 1	0.25 ... 1	0.15 ... 1
	[bar]	2.5 ... 10	2.5 ... 10	2.5 ... 10	1.5 ... 10
Ambient temperature	[°C]	–5 ... +60	–5 ... +60	–10 ... +60	–10 ... +60
Temperature of medium	[°C]	–5 ... +60	–5 ... +60	–10 ... +60	–10 ... +60
Certification	c UL us - Recognized (OL)				
Corrosion resistance class CRC <sup>1)</sup>	2				

1) More information: [www.festo.com/x/topic/kbk](http://www.festo.com/x/topic/kbk)

Information on materials	
Housing	Die-cast aluminium (painted)
Seals	HNBR, NBR, TPE-U(PU)
Screws	Galvanised steel
Note on materials	RoHS-compliant

Data sheet

Dimensions

Download CAD data → [www.festo.com](http://www.festo.com)

3/2-way valve

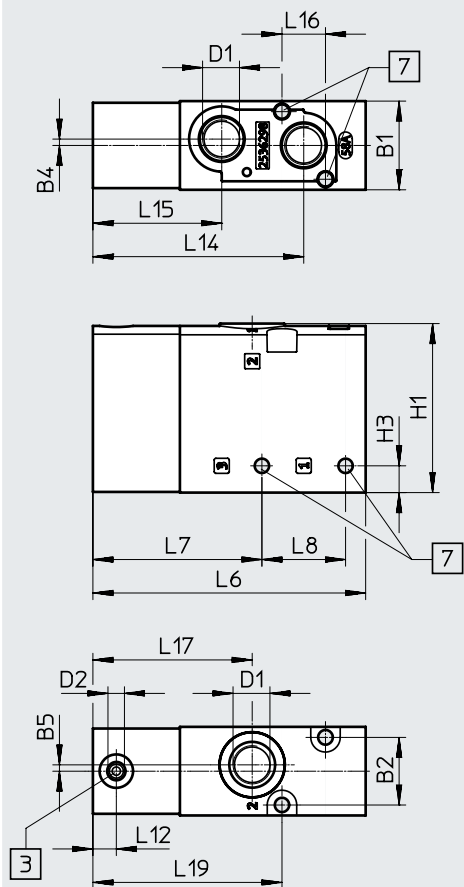

[3] Port 10/12: pilot air

[7] For retaining screw M4

Type	B1	B2	B4	B5	D1	D2	H1	H3
VUWS-LT25-M32...-M-G14	26.5	20.2	1.9	1.9	G1/4	M5	50.5	8

Type	L6	L7	L8	L12	L14	L15	L16	L17	L19
VUWS-LT25-M32...-M-G14	81.6	50.5	25	7	63	38.5	13	47.6	56.5



Data sheet

Dimensions

Download CAD data → [www.festo.com](http://www.festo.com)

5/2-way valve, monostable

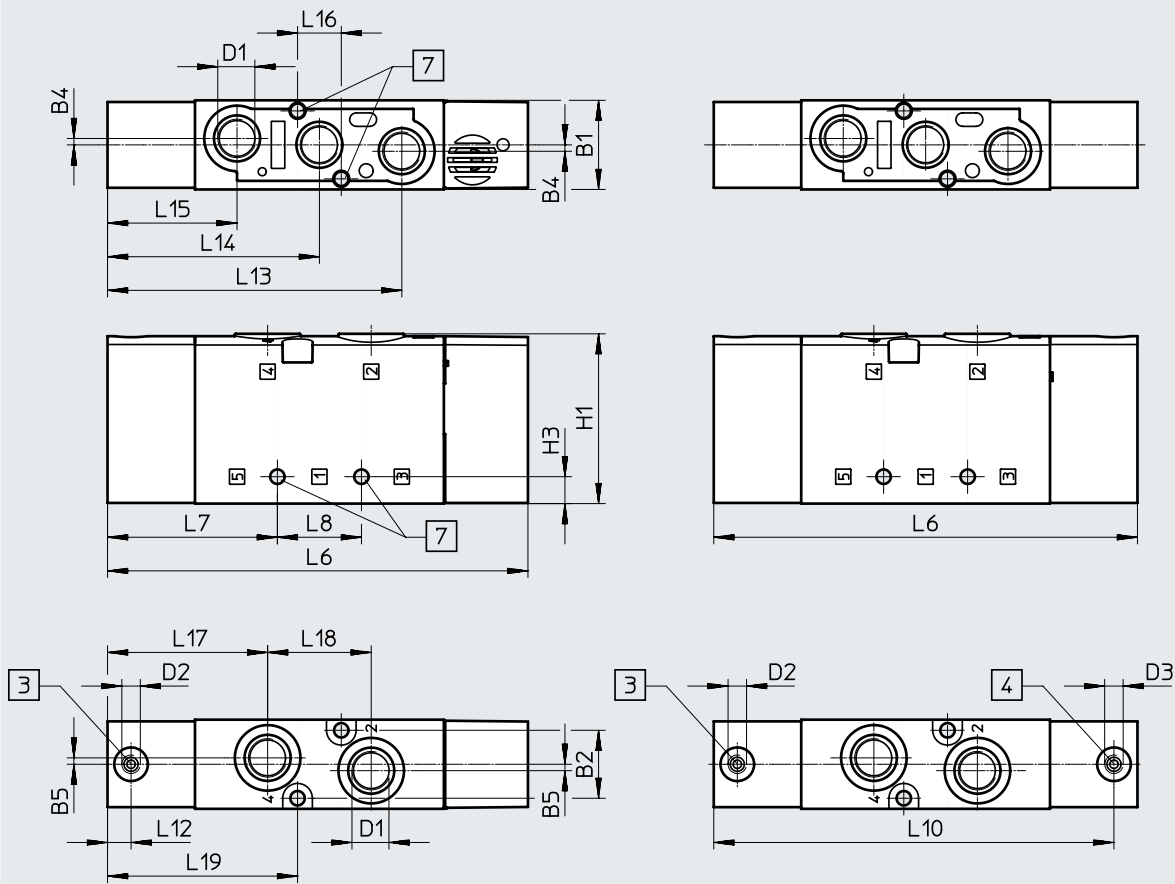

[3] Port 14: pilot air

[4] Port 12: pilot air

[7] For retaining screw M4

Type	B1	B2	B4	B5	D1	D2	D3	H1	H3
VUWS-LT25-M52-M-G14	26.5	20.2	1.9	1.9	G1/4	M5	M5	50.5	8

Type	L6	L7	L8	L12	L13	L14	L15	L16	L17	L18	L19
VUWS-LT25-M52-M-G14	125	50.5	25	7	87.5	63	38.5	13	47.6	30.8	56.5

Data sheet

Dimensions

Download CAD data → [www.festo.com](http://www.festo.com)

2x 3/2-way valve and 5/2-way valve, bistable

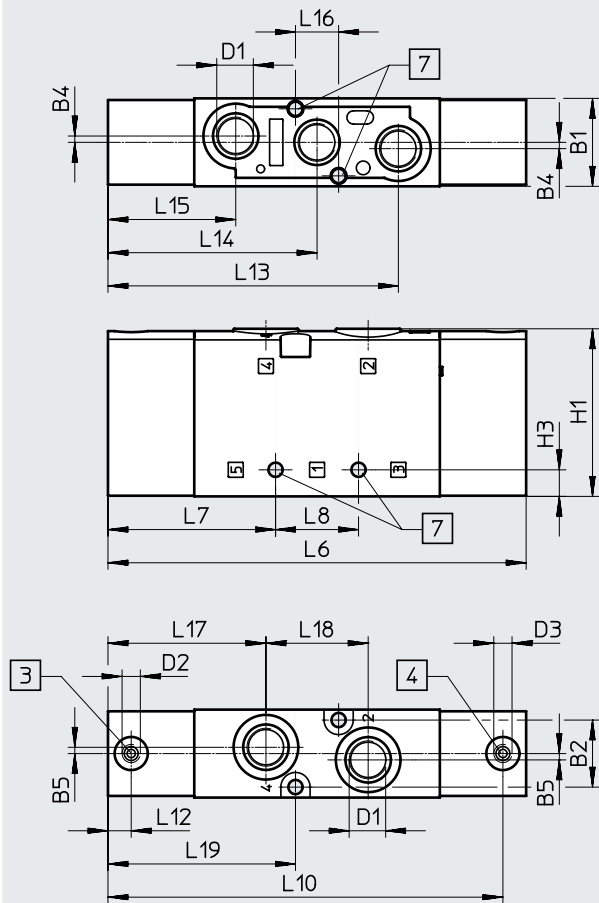

- [3] Port 14: pilot air
- [4] Port 12: pilot air
- [7] For retaining screw M4

Type	B1	B2	B4	B5	D1	D2	D3	H1	H3
VUWS-LT25-B52-G14	26.5	20.2	1.9	1.9	G1/4	M5	M5	50.5	8
VUWS-LT25-T32...-M-G14									

Type	L6	L7	L8	L10	L12	L13	L14	L15	L16	L17	L18	L19
VUWS-LT25-B52-G14	126	50.5	25	119	7	87.5	63	38.5	13	47.6	30.8	56.5
VUWS-LT25-T32...-M-G14												

Accessories

Dimensions

Download CAD data → [www.festo.com](http://www.festo.com)

Foot mounting

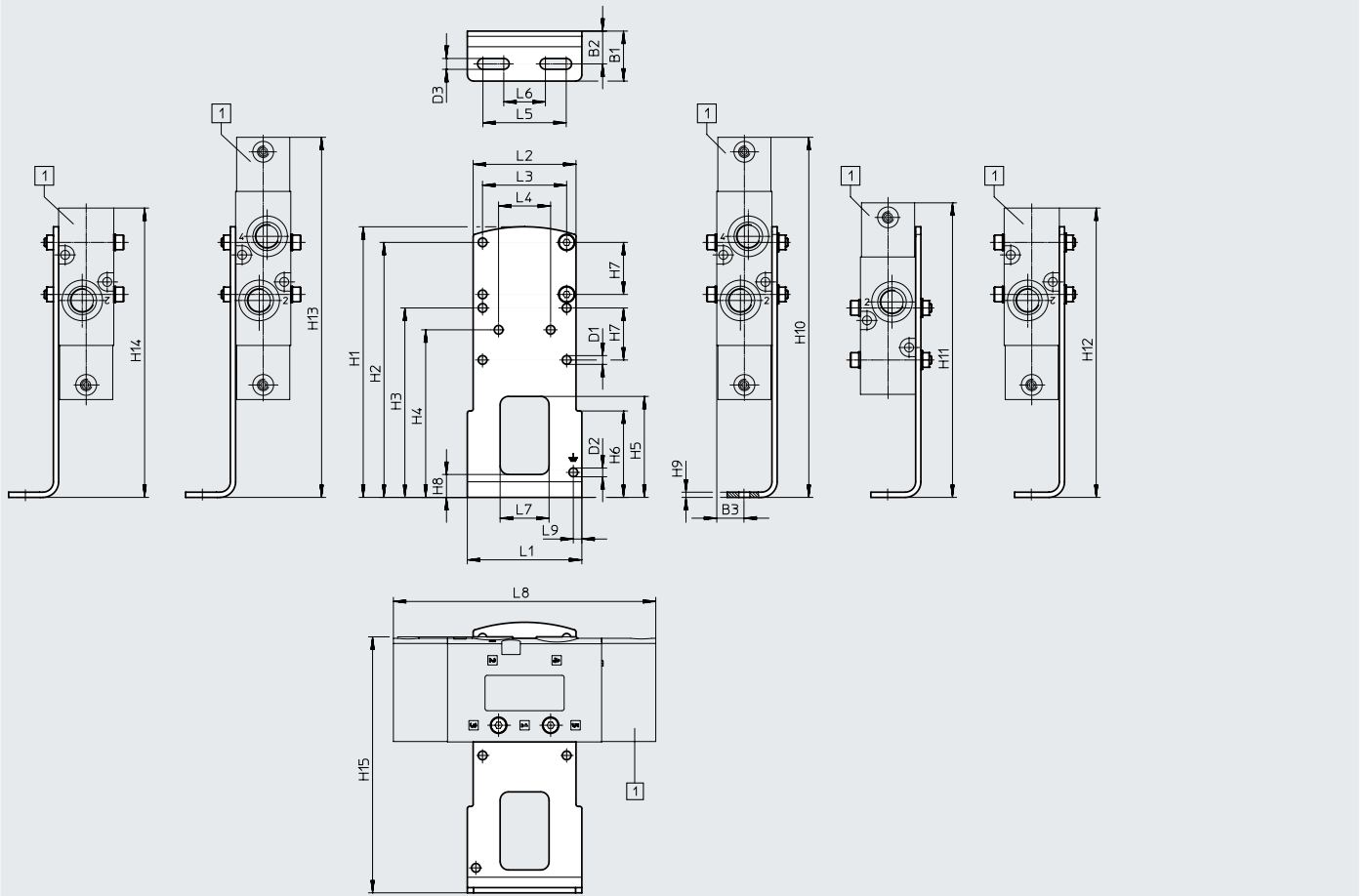

[1] VUWS-LT25-B52,  
VUWS-LT25-T32,  
VUWS-LT25-M52,  
VUWS-LT25-M32

Type		B1	B2	B3	D1 ∅	D2 ∅	D3 ∅	H1	H2	H3	H4
VAME-B10-25-A	VUWS-LT25-B52/T32	24	15.8	13.3	4.2	4.2	5.2	130	122.5	91	80.5
	VUWS-LT25-M52										
	VUWS-LT25-M32										

Type		H5	H6	H7	H8	H9	H10	H11	H12	H13	H14
VAME-B10-25-A	VUWS-LT25-B52/T32	48.5	41.5	25	11	2.5	173	141.5	173	173	173
	VUWS-LT25-M52								172		172
	VUWS-LT25-M32								128.5		128.5

Type		H15	L1	L2	L3	L4	L5	L6	L7	L8	L9
VAME-B10-25-A	VUWS-LT25-B52/T32	123	55	49.4	40.4	25	40	20	23.5	126	4.1
	VUWS-LT25-M52									125	
	VUWS-LT25-M32									81.5	

Accessories

Dimensions Download CAD data → [www.festo.com](http://www.festo.com)

Wall mounting

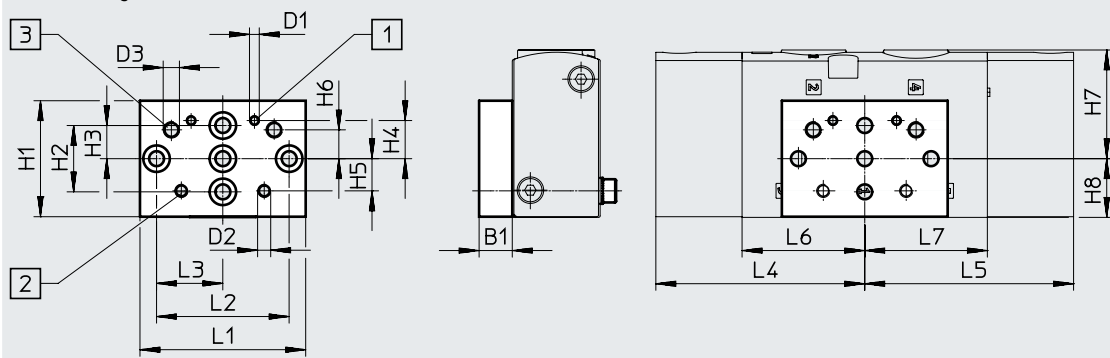



[1] Mounting hole for size 20      [2] Mounting hole for size 25      [3] Mounting hole for size 30





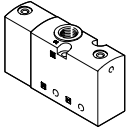
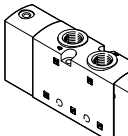
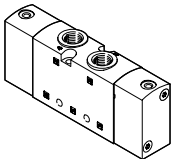

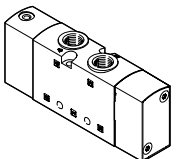
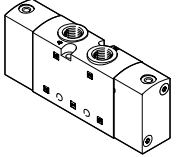
Type		B1	D1	D2	D3	H1	H2	H3	H4	H5	H6
VAME-B10-20-W	VUWS-LT25-B52/T32	10	M3	M4	M5	35	20	10	11.5	9.7	8.7
	VUWS-LT25-M52										
	VUWS-LT25-M32										

Type		H7	H8	L1	L2	L3	L4	L5	L6	L7
VAME-B10-20-W	VUWS-LT25-B52/T32	32.8	17.7	50	40	20	63	63	37	37
	VUWS-LT25-M52									
	VUWS-LT25-M32									

## Accessories

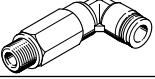

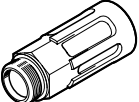
Ordering data – Pneumatic valves				
	Code	Valve function	Part no.	Type
<b>3/2-way valve</b>				
	<b>Normally closed, monostable</b>			
	M32C-M	Reset via mechanical spring, internal pilot air supply, flow direction not reversible	8035173	VUWS-LT25-M32C-M-G14
	<b>Normally open, monostable</b>			
	M32U-M	Reset via mechanical spring, internal pilot air supply, flow direction not reversible	8035180	VUWS-LT25-M32U-M-G14
<b>2x 3/2-way valve</b>				
	<b>Normally closed, monostable</b>			
	T32C	Reset via mechanical spring, internal pilot air supply, flow direction not reversible	8035201	VUWS-LT25-T32C-M-G14
	<b>Normally open, monostable</b>			
	<b>1x normally open, 1x normally closed, monostable</b>			
	T32H	Reset via mechanical spring, internal pilot air supply, flow direction not reversible	8035215	VUWS-LT25-T32H-M-G14
<b>5/2-way valve</b>				
	<b>Monostable</b>			
	M52-M	Reset via mechanical spring, internal pilot air supply, flow direction not reversible	8035187	VUWS-LT25-M52-M-G14
	<b>Bistable</b>			
	B52	internal pilot air supply, flow direction not reversible	8035194	VUWS-LT25-B52-G14

## Accessories

Ordering data	Description		Part no.	Type	PU <sup>1)</sup>
<b>Push-in fitting with internal hex</b>					
	Connecting thread M5 for tubing O.D.	4 mm	153315	QSM-M5-4-I	10
	Connecting thread G1/4 for tubing O.D.	6 mm	186108	QS-G1/4-6-I	10
		8 mm	186110	QS-G1/4-8-I	10
		10 mm	186112	QS-G1/4-10-I	10
<b>Angled push-in fitting with external hex</b>					
	Connecting thread G1/4 for tubing O.D.	6 mm	186118	QSL-G1/4-6	10
			132051	QSL-G1/4-6-100	100
		8 mm	186120	QSL-G1/4-8	10
			132052	QSL-G1/4-8-50	50
		10 mm	186122	QSL-G1/4-10	10
			132053	QSL-G1/4-10-50	50
<b>Angled push-in fitting, long, with external hex</b>					
	Connecting thread G1/4 for tubing O.D.	6 mm	186129	QSL-G1/4-6	10
		8 mm	186131	QSL-G1/4-8	10
		10 mm	186133	QSL-G1/4-10	10
<b>Silencer</b>					
	With connecting thread G, polymer design	G1/4	2316	U-1/4	1
			534223	U-1/4-20	20
	With connecting thread G, metal design	G1/4	6842	U-1/4-B	1
	With connecting thread G, sintered design, long	G1/4	1205861	AMTE-M-LH-G14	20

1) Packaging unit

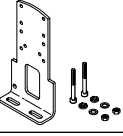
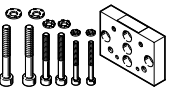
## Accessories

Ordering data	Description	Weight [g]	Part no.	Type
<b>Foot mounting</b>				
	With screw set for attaching the valve to the foot mounting	130	2293485	VAME-B10-25-A
<b>Wall mounting</b>				
	With screw set for attaching the valve to the wall mounting	53	576413	VAME-B10-20-W
<b>Assortment of spare parts</b>				
	Set comprising seals and screws	12	8035636	VAME-B10-25-MK
<b>Inscription label</b>				
	40 pieces in frame	-	565306	ASLR-C-E4

## Data sheet

-  - Flow rate  
up to 1800 l/min

-  - Valve width  
31 mm

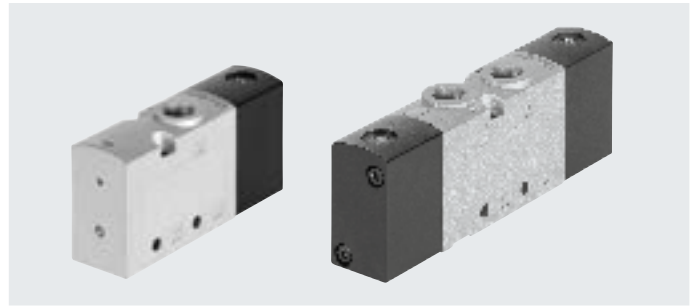

General technical data		3/2-way valve		2x 3/2-way valve			5/2-way valve	
Valve function								
Order code for valves		M32C	M32U	T32C	T32U	T32H	M52	B52
Valve width	[mm]	31						
Design		Poppet seat						
Type of control		Direct						
Manual override (MO)		None						
Flow direction		Non-reversible						
Overlap		Negative overlap						
Sealing principle		Soft						
Type of mounting		Optionally via through-holes or on manifold rail						
Standard nominal flow rate q <sub>nN</sub>	[l/min]	1600	1600	1600	1600	1600	1800	1800
Through-holes (nominal width)	[mm]	7.9	7.9	7.9	7.8	7.8	8.1	8.7
Product weight	[g]	345	352	515	533	524	473	521
Type of actuation		Pneumatic						
Mounting position		Any						
Exhaust function		Can be throttled						
Port for venting hole		Not ducted						
Pneumatic connection	1, 2, 3 4, 5	G3/8	G3/8	G3/8	G3/8	G3/8	G3/8	G3/8
Pneumatic spring connection	12/14, 10	G1/8						

Technical data – 3/2-way valves		M32C	M32U	T32C	T32U	T32H
Order code for valves						
Normal position		Closed	Open	Closed	Open	1x open, 1x closed
Stable position		Monostable				
Reset method		Mechanical spring				
Switching times in [ms]	On	11	12	12	12	12
	Off	37	45	37	45	45



## Data sheet

Technical data – 5/2-way valves		
Order code for valves	M52	B52
Stable position	Monostable	Bistable
Reset method	Mechanical spring	–
Switching times in [ms]	On	17
	Off	77
	Change-over	–
		13

Safety characteristics	
Shock resistance	Shock test with severity level 2 to FN 942017-5 and EN 60068-2-27
Vibration resistance	Transport application test with severity level 2 to FN 942017-4 and EN 60068-2-6

Operating and environmental conditions					
Order code for valves		M32	T32	M52	B52
Operating medium		Compressed air to ISO 8573-1:2010 [7:4:4]			
Pilot medium		Compressed air to ISO 8573-1:2010 [7:4:4]			
Note on the operating/pilot medium		Lubricated operation possible (in which case lubricated operation will always be required)			
Operating pressure	[MPa]	0.1 ... 1	0.1 ... 1	0.25 ... 1	0.15 ... 1
	[bar]	1 ... 10	1 ... 10	2.5 ... 10	1.5 ... 10
Pilot pressure	[MPa]	0.25 ... 1	0.25 ... 1	0.25 ... 1	0.15 ... 1
	[bar]	2.5 ... 10	2.5 ... 10	2.5 ... 10	1.5 ... 10
Ambient temperature	[°C]	–10 ... +60			
Temperature of medium	[°C]	–10 ... +60			
Certification		c UL us - Recognized (OL)			
Corrosion resistance class CRC <sup>1)</sup>		2			

1) More information: [www.festo.com/x/topic/kbk](http://www.festo.com/x/topic/kbk)

Information on materials					
Order code for valves		M32	T32	M52	B52
Housing		Die-cast aluminium (painted)			
Piston spool		POM		Wrought aluminium alloy	
Seals		HNBR, NBR, TPE-U(PU)			
Screws		Galvanised steel			
Note on materials		RoHS-compliant			

## Data sheet

### Dimensions

Download CAD data → [www.festo.com](http://www.festo.com)

3/2-way valve, normally closed/open

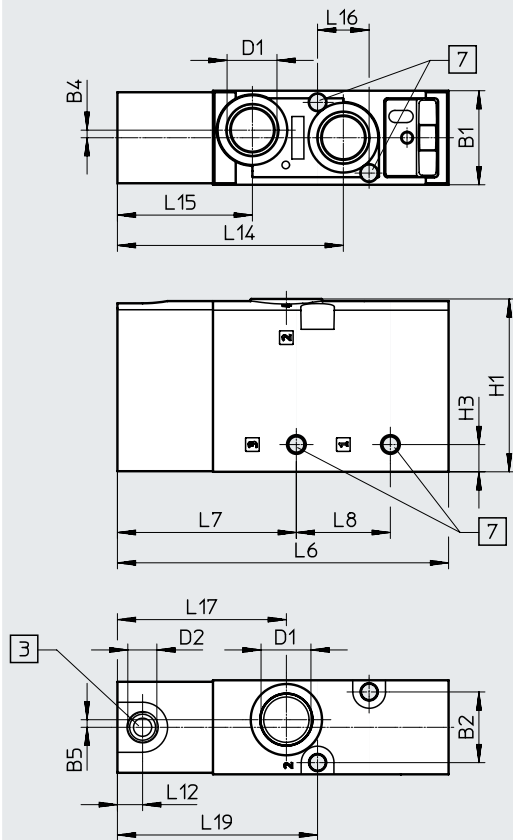

- [3] Port 10: pilot air (...-M32U-...)  
Port 12: pilot air (...-M32C-...)
- [7] For retaining screw M5

Type	B1	B2	B4	B5	D1	D2	H1	H3
VUWS-LT30-M32...-G38	31	23.3	2.5	2.5	G3/8	G1/8	57	9

Type	L6	L7	L8	L12	L14	L15	L16	L17	L19
VUWS-LT30-M32...-G38	109.2	59	31	8.3	74.5	44.5	17	55.7	66

Data sheet

Dimensions

Download CAD data → [www.festo.com](http://www.festo.com)

5/2-way valve, monostable

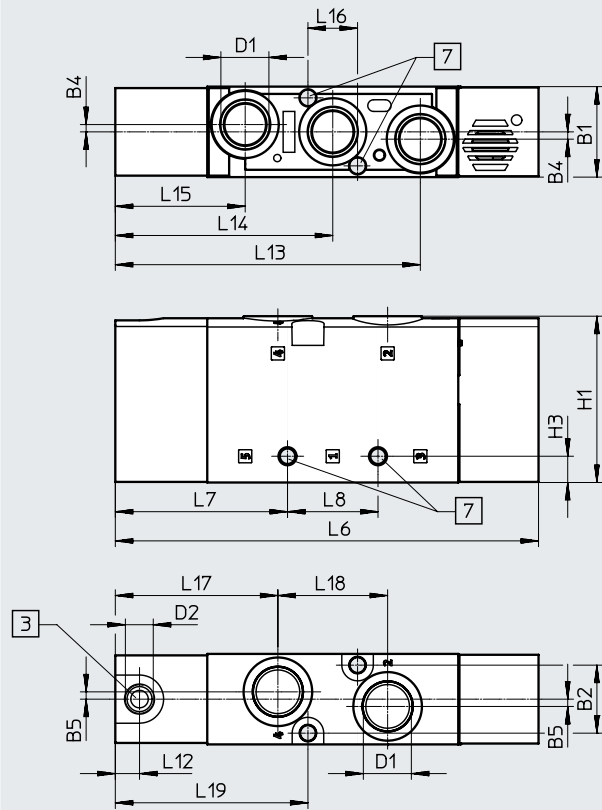

[3] Port 14: pilot air

[7] For retaining screw M5

Type	B1	B2	B4	B5	D1	D2	H1	H3
VUWS-LT30-M52-...-G38	31	23.3	2.5	2.5	G3/8	G1/8	57	9

Type	L6	L7	L8	L12	L13	L14	L15	L16	L17	L18	L19
VUWS-LT30-M52-...-G38	145	59	31	8.3	104.5	74.5	44.5	17	55.7	37.6	66

Data sheet

Dimensions

Download CAD data → [www.festo.com](http://www.festo.com)

2x 3/2-way valve and 5/2-way valve, bistable

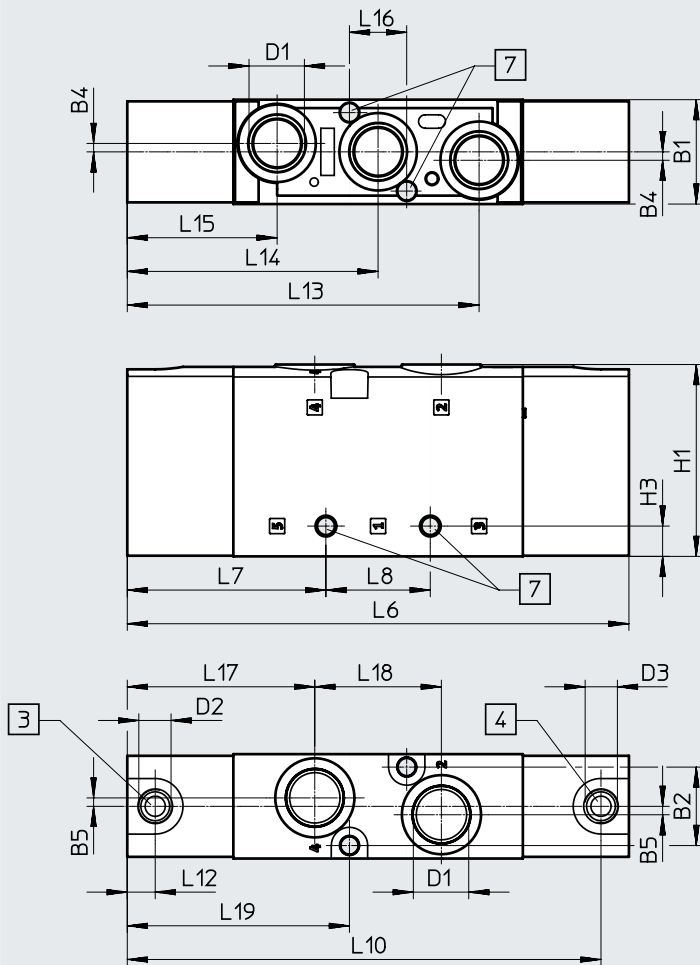

- [3] Port 14: pilot air
- [4] Port 12: pilot air
- [7] For retaining screw M5

Type	B1	B2	B4	B5	D1	D2	D3	H1	H3
VUWS-LT30-B52-G38	31	23.3	2.5	2.5	G3/8	G1/8	G1/8	57	9
VUWS-LT30-T32-...-M-G38									

Type	L6	L7	L8	L10	L12	L13	L14	L15	L16	L17	L18	L19
VUWS-LT30-B52-G38	149	59	31	140.7	8.3	104.5	74.5	44.5	17	55.7	37.6	66
VUWS-LT30-T32-...-M-G38												

Accessories

Dimensions

Foot mounting

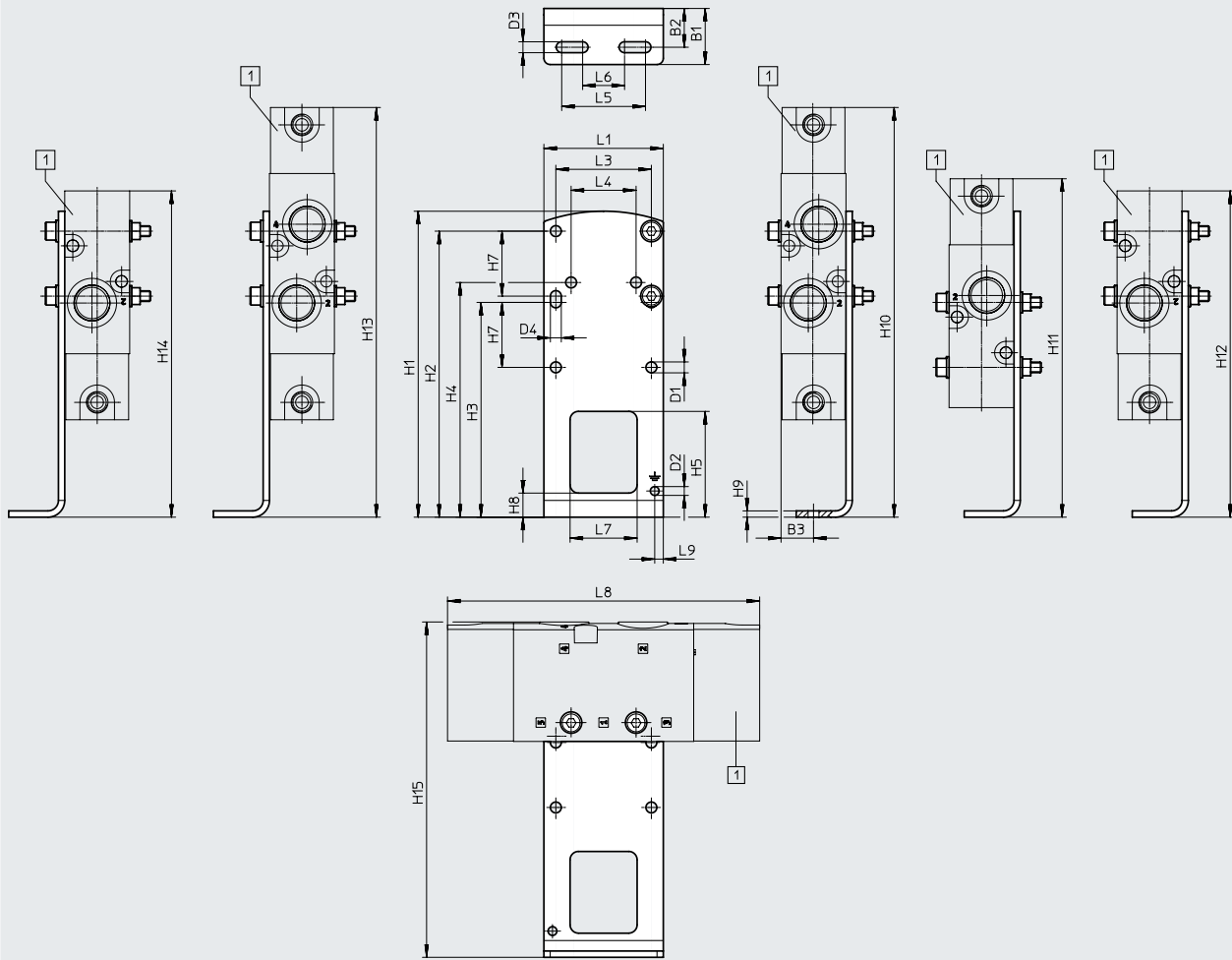

[1] VUWS-LT30-B52,  
VUWS-LT30-T32,  
VUWS-LT30-M52,  
VUWS-LT30-M32

Type		B1	B2	B3	D1 ∅	D2 ∅	D3	D4	H1	H2	H3
VAME-B10-30-A	VUWS-LT30-B52/T32	26.8	18.5	15.5	5.2	4.2	5.2	5.2	146	136.5	102.5
	VUWS-LT30-M52										
	VUWS-LT30-M32										

Type		H4	H5	H7	H8	H9	H10	H11	H12	H13	H14
VAME-B10-30-A	VUWS-LT30-B52/T32	112	50.5	31	11.5	3	195.5	161.5	195.5	195.5	195.5
	VUWS-LT30-M52								191.5		191.5
	VUWS-LT30-M32								144		144

Type		H15	L1	L3	L4	L5	L6	L7	L8	L9
VAME-B10-30-A	VUWS-LT30-B52/T32	160	57	45.6	31	40	20	32	149	4.1
	VUWS-LT30-M52								145	
	VUWS-LT30-M32								97.5	

Accessories

Dimensions

Wall mounting

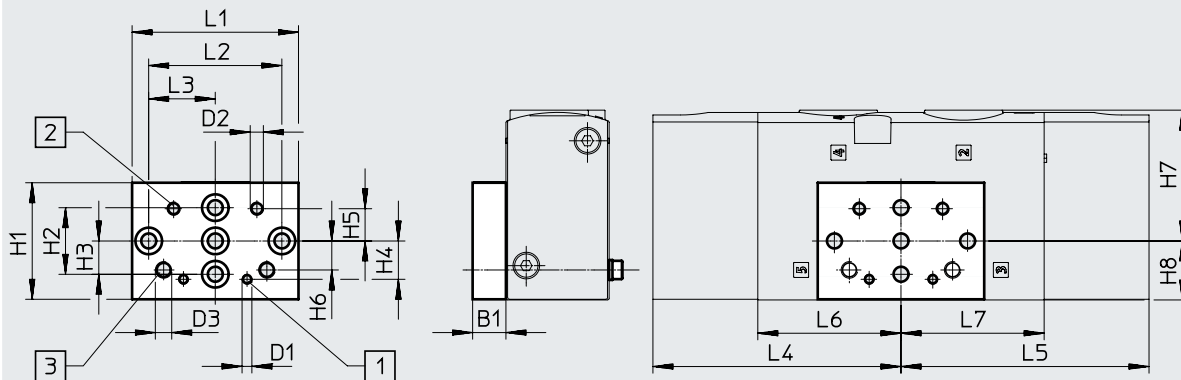

[1] Mounting hole for size 20



[2] Mounting hole for size 25

[3] Mounting hole for size 30



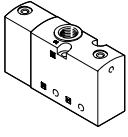
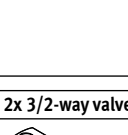
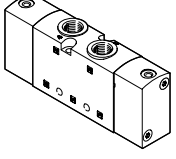

Type		B1	D1	D2	D3	H1	H2	H3	H4	H5	H6
VAME-B10-20-W	VUWS-LT30-B52/T32	10	M3	M4	M5	35	20	10	11.5	9.7	8.7
	VUWS-LT30-M52										
	VUWS-LT30-M32										

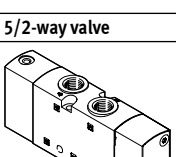
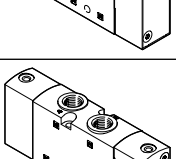
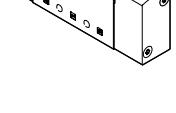
Type		H7	H8	L1	L2	L3	L4	L5	L6	L7
VAME-B10-20-W	VUWS-LT30-B52/T32	39.3	17.7	50	40	20	74.5	74.5	43	43
	VUWS-LT30-M52							70.5		-
	VUWS-LT30-M32							23		

## Accessories

Ordering data – Pneumatic valves				
	Code	Valve function	Part no.	Type
<b>3/2-way valve</b>				
	<b>Normally closed, monostable</b>			
	M32C-M	Reset via mechanical spring, internal pilot air supply, flow direction not reversible	8096574	VUWS-LT30-M32C-M-G38
	<b>Normally open, monostable</b>			
	M32U-M	Reset via mechanical spring, internal pilot air supply, flow direction not reversible	8096575	VUWS-LT30-M32U-M-G38
<b>2x 3/2-way valve</b>				
	<b>Normally closed, monostable</b>			
	T32C	Reset via mechanical spring, internal pilot air supply, flow direction not reversible	8036706	VUWS-LT30-T32C-M-G38
	<b>Normally open, monostable</b>			
	<b>Normally open, monostable</b>			
	T32U	Reset via mechanical spring, internal pilot air supply, flow direction not reversible	8036713	VUWS-LT30-T32U-M-G38
	<b>1x normally open, 1x normally closed, monostable</b>			
	T32H	Reset via mechanical spring, internal pilot air supply, flow direction not reversible	8036720	VUWS-LT30-T32H-M-G38
<b>5/2-way valve</b>				
	<b>Monostable</b>			
	M52-M	Reset via mechanical spring, internal pilot air supply, flow direction not reversible	8096576	VUWS-LT30-M52-M-G38
	<b>Bistable</b>			
	B52	Internal pilot air supply, flow direction not reversible	8096577	VUWS-LT30-B52-G38

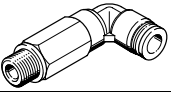
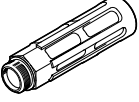

## Accessories

Ordering data	Description		Part no.	Type	PU <sup>1)</sup>
<b>Push-in fitting with internal hex</b>					
	Connecting thread G1/8 for tubing O.D.	4 mm	186106	QS-G1/8-4-I	10
			133008	QS-G1/8-4-I-100	100
		6 mm	186107	QS-G1/8-6-I	10
			133009	QS-G1/8-6-I-100	100
	Connecting thread G3/8 for tubing O.D.	8 mm	186111	QS-G3/8-8-I	10
			10 mm	186113	QS-G3/8-10-I
12 mm			186114	QS-G3/8-12-I	10
<b>Angled push-in fitting with external hex</b>					
	Connecting thread G3/8 for tubing O.D.	8 mm	186121	QSL-G3/8-8	10
			132055	QSL-G3/8-8-50	50
		10 mm	186123	QSL-G3/8-10	10
			132056	QSL-G3/8-10-20	20
		12 mm	186124	QSL-G3/8-12	10
			132057	QSL-G3/8-12-20	20
<b>Angled push-in fitting, long, with external hex</b>					
	Connecting thread G3/8 for tubing O.D.	8 mm	186132	QSL-G3/8-8	10
		10 mm	186134	QSL-G3/8-10	10
		12 mm	186135	QSL-G3/8-12	10
<b>Silencer</b>					
	With connecting thread G, metal design	G3/8	6843	U-3/8-B	1
	With connecting thread G, sintered design, long	G3/8	1205862	AMTE-M-LH-G38	10

1) Packaging unit

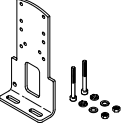
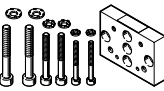
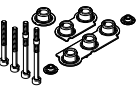

## Accessories

Ordering data	Description	Weight [g]	Part no.	Type
<b>Foot mounting</b>				
	Set for mounting valves, comprising: <ul style="list-style-type: none"> <li>• Mounting bracket and</li> <li>• Screw set for mounting</li> </ul>	-	8026337	VAME-B10-30-A
<b>Wall mounting</b>				
	Set for mounting valves for size 20, 25, 30, comprising: <ul style="list-style-type: none"> <li>• Wall mounting and</li> <li>• Screw set for mounting</li> </ul>	53	576413	VAME-B10-20-W
<b>Assortment of spare parts</b>				
	Set comprising: <ul style="list-style-type: none"> <li>• Seals and</li> <li>• Screws</li> </ul>	-	8035637	VAME-B10-30-MK
<b>Inscription label</b>				
	40 pieces in frame	-	565306	ASLR-C-E4

## Data sheet

-  - Flow rate  
up to 700 l/min

-  - Valve width  
21 mm

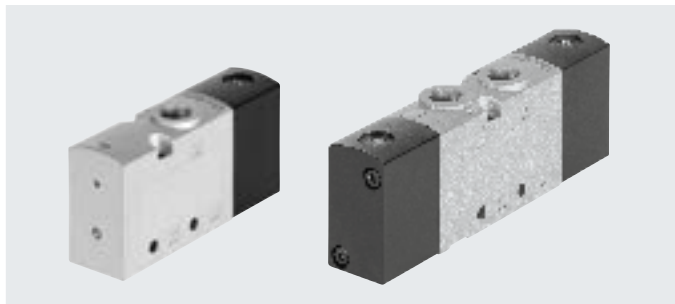

General technical data		3/2		5/2		5/3					
Valve function		M32C		M32U		M52		B52	P53C	P53U	P53E
Order code for valves		M32C	M32U	M52	B52	P53C	P53U	P53E			
Valve width	[mm]	21									
Design		Piston spool									
Pneumatic spring supply		Internal or external (external: identified by E in type code)									
Type of control		Direct									
Manual override (MO)		None									
Flow direction		Reversible with restrictions									
Overlap		Positive overlap									
Sealing principle		Soft									
Type of mounting		Optionally via through-holes <sup>1)</sup> or on manifold rail									
Standard nominal flow rate qnN	[l/min]	700		700		700	600	600			
Through-holes (nominal width)	[mm]	5.7		5.7		5.0	4.8	4.5			
Product weight	[g]	145		178/190 <sup>2)</sup>		211	207	207	207		
Type of actuation		Pneumatic									
Mounting position		Any									
Exhaust function		Can be throttled									
Venting hole		Not ducted									
Pneumatic connection	1, 2, 3 4, 5	G1/8	G1/8	G1/8	G1/8	G1/8	G1/8	G1/8	G1/8	G1/8	G1/8
Pneumatic spring connection	12/14, 10	M5									

1) If several valves are to be screwed together via through-holes to form a block, a minimum distance of 0.3 mm must be ensured by placing spacer discs between them.  
2) With external pneumatic spring: 190 g, with internal pneumatic spring or mechanical spring: 178 g

## Data sheet

Technical data – 3/2-way valves					
Order code for valves		M32C		M32U	
Normal position		Closed		Open	
Stable position		Monostable		Monostable	
Reset method		Pneumatic spring	Mechanical spring (supported internally by pneumatic spring)	Pneumatic spring	Mechanical spring (supported internally by pneumatic spring)
Switching times in [ms]	On	7	10	7	10
	Off	15	28	15	28
	Change-over	–	–	–	–

Technical data – 5/2-way valves				
Order code for valves		M52		B52
Stable position		Monostable		Bistable
Reset method		Pneumatic spring	Mechanical spring	–
Switching times in [ms]	On	13	7	–
	Off	26	39	–
	Change-over	–	–	6

Technical data – 5/3-way valves					
Order code for valves		P53C		P53U	P53E
Stable position		Monostable			
Reset method		Mechanical spring			
Switching times in [ms]	On	10	10	10	
	Off	44	43	46	
	Change-over	26	21	21	

Safety characteristics	
Shock resistance	Shock test with severity level 2 to FN 942017-5 and EN 60068-2-27
Vibration resistance	Transport application test with severity level 2 to FN 942017-4 and EN 60068-2-6

Operating and environmental conditions							
Valve function		M32 ... A M32 ... M	M32C-E M32U-E	M52-A	M52-E M52-M	B52	P53
Operating medium		Compressed air to ISO 8573-1:2010 [7:4:4]					
Pilot medium		Compressed air to ISO 8573-1:2010 [7:4:4]					
Note on the operating/pilot medium		Lubricated operation possible (in which case lubricated operation will always be required)					
Operating pressure	[MPa]	0.25 ... 1	–0.09 ... +1	0.25 ... 1	–0.09 ... +1	–0.09 ... +1	–0.09 ... +1
	[bar]	2.5 ... 10	–0.9 ... +10	2.5 ... 10	–0.9 ... +10	–0.9 ... +10	–0.9 ... +10
Pilot pressure	[MPa]	0.25 ... 1	0.25 ... 1	0.25 ... 1	0.25 ... 1	0.15 ... 1	0.25 ... 1
	[bar]	2.5 ... 10	2.5 ... 10	2.5 ... 10	2.5 ... 10	1.5 ... 10	2.5 ... 10
Ambient temperature	[°C]	–10 ... +60					
Temperature of medium	[°C]	–10 ... +60					
Certification		c UL us - Recognized (OL)					
Corrosion resistance class CRC <sup>1)</sup>		2					

1) More information: [www.festo.com/x/topic/kbk](http://www.festo.com/x/topic/kbk)

## Data sheet

Information on materials	
Housing	Die-cast aluminium (painted)
Seals	HNBR, NBR
Piston spool	Wrought aluminium alloy (P53 types: High-alloy stainless steel)
Screws	Galvanised steel
Note on materials	RoHS-compliant

### Special features of pneumatic 3/2-way valves

Reset: mechanical spring

Reset: pneumatic spring

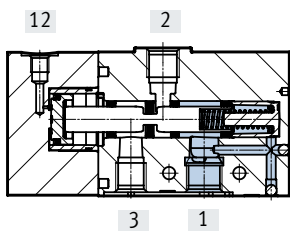

#### Internal pneumatic spring

- Faster switch-off time
- In the case of dual-pressure operation, the higher pressure must always be present at port 1
- Pressure on port 2 not permitted

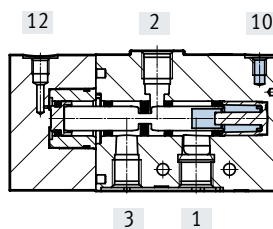

#### External pneumatic spring

- Can be used as a bistable valve
- Signal pressure depends on the pressure of the pneumatic spring
- No impairment of the switching function caused by vacuum
- Pressure is permitted on port 2

Data sheet

Dimensions

Download CAD data → [www.festo.com](http://www.festo.com)

3/2-way valve, normally closed/open

3/2-way valve, normally closed/open, external pilot air

VUWS-L20-M32...-E-...

- [3] Port 10: pilot air (...-M32U-...)  
Port 12: pilot air (...-M32C-...)
- [4] Port 10: for external pneumatic spring (...-M32C-E-...)  
Port 12: for external pneumatic spring (...-M32U-E-...)
- [7] For retaining screw M3

Type	B1	B2	B3	B4	B5	D1	D2	D3	H1	H3
VUWS-L20-M32C-...-G18	21.1	16.1	-	2.5	2	G1/8	M5	-	40.4	6.2
VUWS-L20-M32U-...-G18			-					-		
VUWS-L20-M32C-E-...-G18			1.5					M5		
VUWS-L20-M32U-E-...-G18			1.5					M5		

Type	L6	L7	L8	L10	L12	L14	L15	L16	L17	L19
VUWS-L20-M32C-...-G18	77	44.1	19.2	-	8.8	53.7	33.7	8	42.5	49.7
VUWS-L20-M32U-...-G18				-						
VUWS-L20-M32C-E-...-G18				72						
VUWS-L20-M32U-E-...-G18				72						

Data sheet

Dimensions

Download CAD data → [www.festo.com](http://www.festo.com)

5/2-way valve, monostable, external pilot air

5/2-way valve, monostable

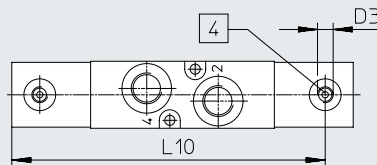
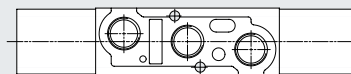
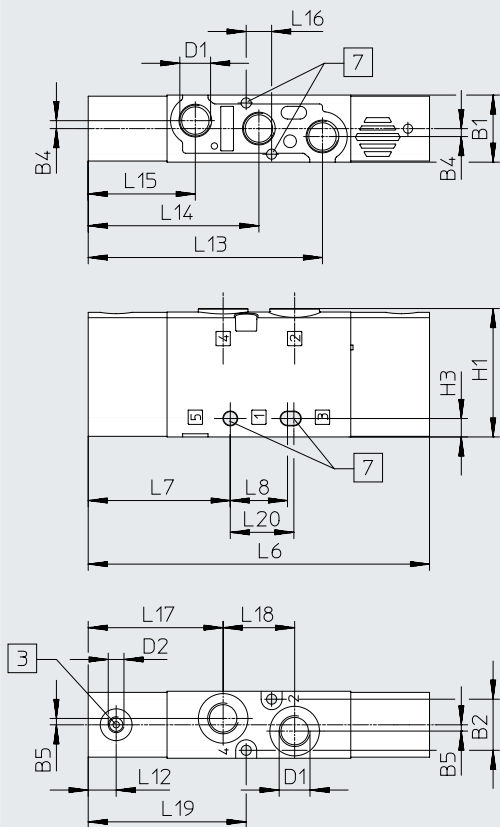

- [3] Port 14: pilot air (-M52-...)
- [4] Port 12: pilot air (pneumatic spring) (...-M52-E-...)
- [7] For retaining screw M4

Type	B1	B2	B4	B5	D1	D2	D3	H1	H3
VUWS-L20-M52-...-G18	21.1	16.1	2.5	2	G1/8	M5	-	40.4	5.8
VUWS-L20-M52-E-G18					G1/8	M5	M5		

Type	L6	L7	L8	L10	L12	L13	L14	L15	L16	L17	L18	L19	L20
VUWS-L20-M52-...-G18	107.4	44.7	18	-	8.8	73.7	53.7	33.7	8	42.5	22.5	49.7	20
VUWS-L20-M52-E-G18				98.6									

Data sheet

Dimensions

Download CAD data → [www.festo.com](http://www.festo.com)

5/2-way valve, bistable, 5/3-way valve

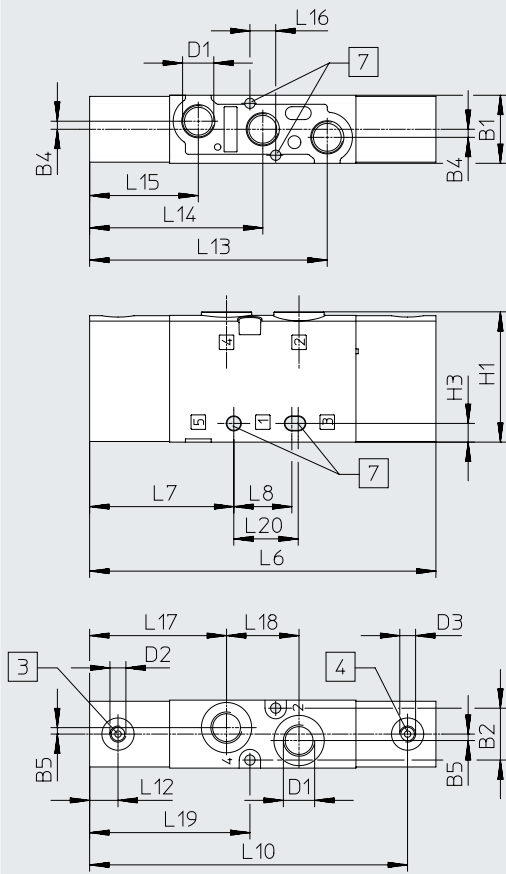

- [3] Port 14: pilot air
- [4] Port 12: pilot air
- [7] For retaining screw M4

Type	B1	B2	B4	B5	D1	D2	D3	H1	H3
VUWS-L20-P53-...-M-G18	21.1	16.1	2.5	2	G1/8	M5	M5	40.4	5.8
VUWS-L20-B52-G18									

Type	L6	L7	L8	L10	L12	L13	L14	L15	L16	L17	L18	L19	L20
VUWS-L20-P53-...-M-G18	107.4	44.7	18	98.6	8.8	73.7	53.7	33.7	8	42.5	22.5	49.7	20
VUWS-L20-B52-G18													

Data sheet

Dimensions

Foot mounting

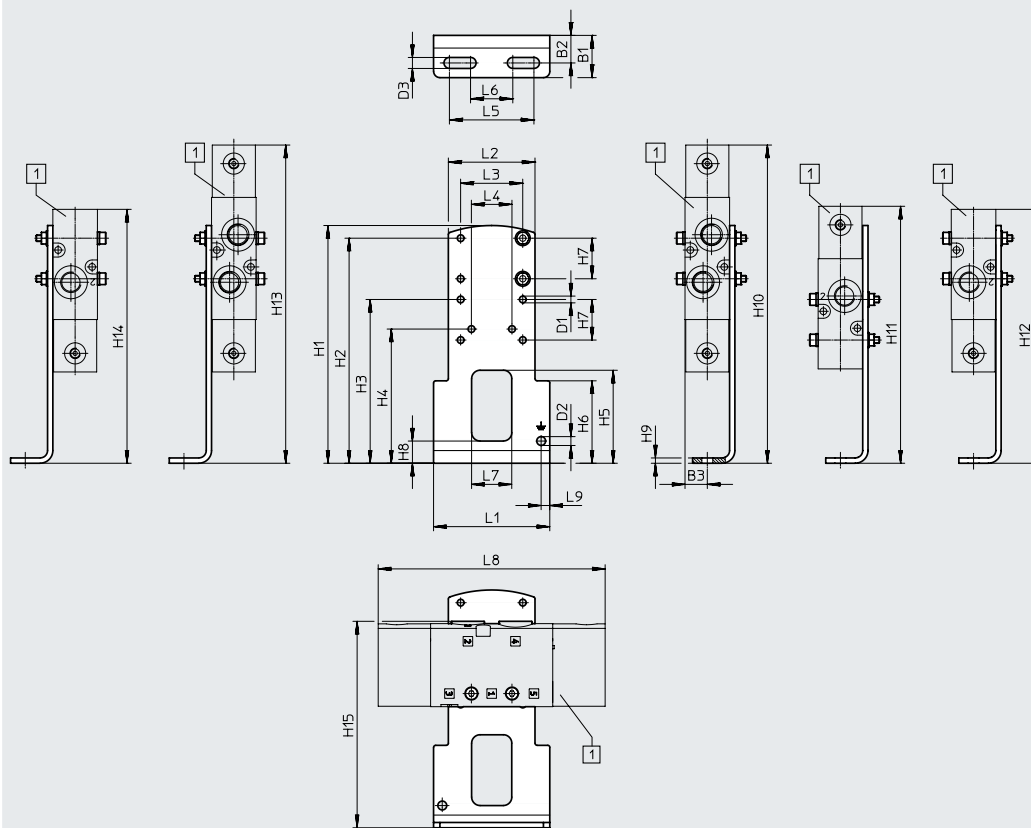

[1] VUWS-L20-B52,  
VUWS-L20-P53,  
VUWS-L20-M52,  
VUWS-L20-M32

Type		B1	B2	B3	D1 ∅	D2 ∅	D3 ∅	H1	H2	H3	H4
VAME-B10-20-A	VUWS-L20-B52/P53	20	13.1	10.6	3.2	4.2	5.2	112.5	106.5	77.5	63.5
	VUWS-L20-M52										
	VUWS-L20-M32										

Type		H5	H6	H7	H8	H9	H10	H11	H12	H13	H14
VAME-B10-20-A	VUWS-L20-B52/P53	44	39	19.2	10.5	2.5	150.6	121.6	150.6	150.6	150.6
	VUWS-L20-M52								120.2		
	VUWS-L20-M32								120.2		

Type		H15	L1	L2	L3	L4	L5	L6	L7	L8	L9
VAME-B10-20-A	VUWS-L20-B52/P53	97.7	55	41	29.4	19.2	40	20	19	107.4	4.1
	VUWS-L20-M52									77	
	VUWS-L20-M32									77	



## Data sheet

### Dimensions

Wall mounting

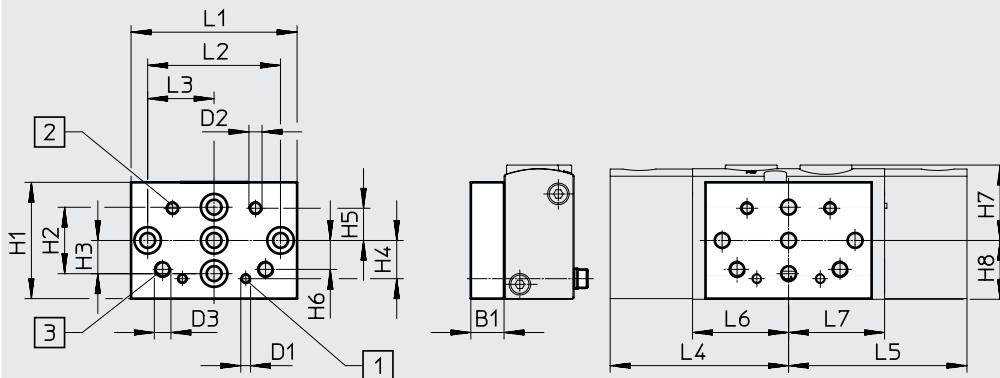

[1] Mounting hole for size 20

[2] Mounting hole for size 25

[3] Mounting hole for size 30



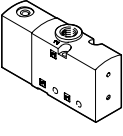
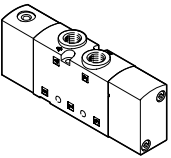
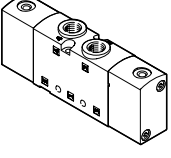

Type		B1	D1	D2	D3	H1	H2	H3	H4	H5	H6
VAME-B10-20-W	VUWS-L20-B52/P53	10	M3	M4	M5	35	20	10	11.5	9.7	8.7
	VUWS-L20-M52										
	VUWS-L20-M32										

Type		H7	H8	L1	L2	L3	L4	L5	L6	L7
VAME-B10-20-W	VUWS-L20-B52/P53	22.7	17.7	50	40	20	53.7	53.7	28.9	28.9
	VUWS-L20-M52									
	VUWS-L20-M32									

## Ordering data – Pneumatic valves, size 20

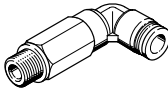
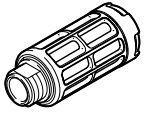
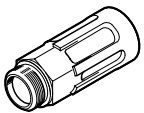

Ordering data – Pneumatic valves				
	Code	Valve function	Part no.	Type
<b>3/2-way valve</b>				
	<b>Normally closed, monostable</b>			
	M32C-A	Reset via pneumatic spring, internal pneumatic spring, flow direction not reversible	575669	VUWS-L20-M32C-A-G18
	M32C-E	Reset via pneumatic spring, external pneumatic spring, flow direction reversible	575670	VUWS-L20-M32C-E-G18
	M32C-M	Reset via mechanical spring, supported by internal pneumatic spring, flow direction not reversible	575671	VUWS-L20-M32C-M-G18
	<b>Normally open, monostable</b>			
	M32U-A	Reset via pneumatic spring, internal pneumatic spring, flow direction not reversible	575672	VUWS-L20-M32U-A-G18
	M32U-E	Reset via pneumatic spring, external pneumatic spring, flow direction reversible	575673	VUWS-L20-M32U-E-G18
	M32U-M	Reset via mechanical spring, supported by internal pneumatic spring, flow direction not reversible	575674	VUWS-L20-M32U-M-G18
	<b>5/2-way valve</b>			
	<b>Monostable</b>			
	M52-A	Reset via pneumatic spring, internal pneumatic spring, flow direction not reversible	575677	VUWS-L20-M52-A-G18
	M52-E	Reset via pneumatic spring, external pneumatic spring, flow direction reversible	575678	VUWS-L20-M52-E-G18
	M52-M	Reset via mechanical spring, flow direction reversible	575681	VUWS-L20-M52-M-G18
	<b>Bistable</b>			
B52	Flow direction reversible	575684	VUWS-L20-B52-G18	
<b>5/3-way valve</b>				
	P53C	Closed, Reset via mechanical spring, flow direction reversible	575687	VUWS-L20-P53C-M-G18
	P53E	Exhausted, Reset via mechanical spring, flow direction reversible	575693	VUWS-L20-P53E-M-G18
	P53U	Pressurised, Reset via mechanical spring, flow direction reversible	575690	VUWS-L20-P53U-M-G18

## Accessories

Ordering data		Description	Part no.	Type	PU <sup>1)</sup>
<b>Push-in fitting with internal hex</b>					
	Connecting thread M5 for tubing O.D.	4 mm	153315	QSM-M5-4-I	10
	Connecting thread G1/8 for tubing O.D.	4 mm	186106	QS-G1/8-4-I	10
		4 mm	133008	QS-G1/8-4-I-100	100
		6 mm	186107	QS-G1/8-6-I	10
			133009	QS-G1/8-6-I-100	100
		8 mm	186109	QS-G1/8-8-I	10
			133010	QS-G1/8-8-I-100	100
<b>Angled push-in fitting with external hex</b>					
	Connecting thread G1/8 for tubing O.D.	4 mm	186116	QSL-G1/8-4	10
			132048	QSL-G1/8-4-100	100
		6 mm	186117	QSL-G1/8-6	10
			132049	QSL-G1/8-6-100	100
		8 mm	186119	QSL-G1/8-8	10
132050	QSL-G1/8-8-50	50			
<b>Angled push-in fitting, long, with external hex</b>					
	Connecting thread G1/8 for tubing O.D.	4 mm	186127	QSL-G1/8-4	10
			133015	QSL-G1/8-4-100	100
		6 mm	186128	QSL-G1/8-6	10
			133016	QSL-G1/8-6-100	100
		8 mm	186130	QSL-G1/8-8	10
133017	QSL-G1/8-8-100	100			
<b>Silencer</b>					
	With connecting thread G, polymer design	G1/8	2307	U-1/8	1
			534222	U-1/8-50	50
	With connecting thread G, metal design	G1/8	6841	U-1/8-B	1
	With connecting thread G, sintered design, long	G1/8	1205860	AMTE-M-LH-G18	20

1) Packaging unit

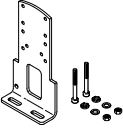
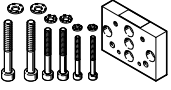
## Accessories

Ordering data	Description	Weight [g]	Part no.	Type
<b>Foot mounting</b>				
	Set for mounting valves, comprising: <ul style="list-style-type: none"> <li>• Mounting bracket and</li> <li>• Screw set for mounting</li> </ul>	97	576412	VAME-B10-20-A
<b>Wall mounting</b>				
	Set for mounting valves for size 20, 25, 30, comprising: <ul style="list-style-type: none"> <li>• Wall mounting and</li> <li>• Screw set for mounting</li> </ul>	53	576413	VAME-B10-20-W
<b>Assortment of spare parts</b>				
	Set comprising: <ul style="list-style-type: none"> <li>• Seals and</li> <li>• Screws</li> </ul>	10	8026203	VAME-B10-20-MK
<b>Inscription label</b>				
	40 pieces in frame	-	565306	ASLR-C-E4

## Data sheet

-  - Flow rate  
up to 1300 l/min

-  - Valve width  
26.5 mm

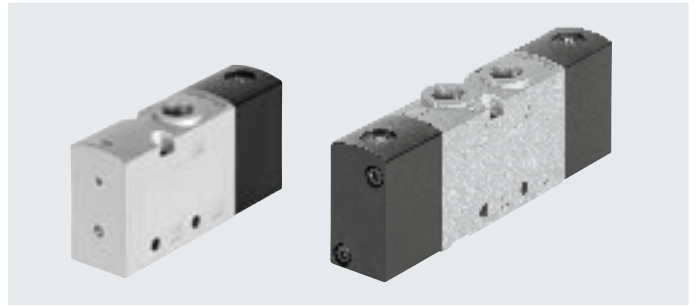

## General technical data

Valve function	3/2		5/2		5/3		
Order code for valves	M32C	M32U	M52	B52	P53C	P53U	P53E
Valve width [mm]	26.5						
Design	Piston spool						
Pneumatic spring supply	Internal or external (external: identified by E in type code)						
Type of control	Direct						
Manual override (MO)	None						
Flow direction	Reversible with restrictions (not reversible: identified by A in type code)						
Overlap	Positive overlap						
Sealing principle	Soft						
Type of mounting	Optionally via through-holes <sup>1)</sup> or on manifold rail						
Standard nominal flow rate q <sub>N</sub> [l/min]	1000	1000	1300	1300	1200	1000	1000
Through-holes (nominal width) [mm]	6.3	6.3	6.9	6.9	6.5	6.3	6.3
Product weight [g]	268	268	330/360 <sup>2)</sup>	363	364	364	364
Type of actuation	Pneumatic						
Mounting position	Any						
Exhaust function	Can be throttled						
Venting hole	Not ducted						
Pneumatic connection	1, 2, 3 4, 5	G1/4	G1/4	G1/4	G1/4	G1/4	G1/4
Pneumatic spring connection 12/14, 10	M5						

1) If several valves are to be screwed together via through-holes to form a block, a minimum distance of 0.3 mm must be ensured by placing spacer discs between them.

2) With external pneumatic spring: 360 g, with internal pneumatic spring or mechanical spring: 330 g

## Technical data – 3/2-way valves

Order code for valves	M32C		M32U	
Normal position	Closed		Open	
Stable position	Monostable		Monostable	
Reset method	Pneumatic spring		Mechanical spring	
Switching times in [ms]	On	10	10	10
	Off	25	43	25
	Change-over	–	–	–

## Data sheet

Technical data – 5/2-way valves			
Order code for valves		M52	B52
Stable position		Monostable	
Reset method		Pneumatic spring	Mechanical spring
Switching times in [ms]	On	15	10
	Off	32	42
	Change-over	–	–
			10

Technical data – 5/3-way valves				
Order code for valves		P53C	P53U	P53E
Stable position		Monostable		
Reset method		Mechanical spring		
Switching times in [ms]	On	13	13	13
	Off	65	65	65
	Change-over	30	30	30

Safety characteristics	
Shock resistance	Shock test with severity level 2 to FN 942017-5 and EN 60068-2-27
Vibration resistance	Transport application test with severity level 2 to FN 942017-4 and EN 60068-2-6

Operating and environmental conditions							
Valve function		M32 ... A	M32 ... E M32 ... M	M52-A	M52-E M52-M	B52	P53
Operating medium		Compressed air to ISO 8573-1:2010 [7:4:4]					
Pilot medium		Compressed air to ISO 8573-1:2010 [7:4:4]					
Note on the operating/pilot medium		Lubricated operation possible (in which case lubricated operation will always be required)					
Operating pressure	[MPa]	0.25 ... 1	–0.09 ... +1	0.25 ... 1	–0.09 ... +1	–0.09 ... +1	–0.09 ... +1
	[bar]	2.5 ... 10	–0.9 ... +10	2.5 ... 10	–0.9 ... +10	–0.9 ... +10	–0.9 ... +10
Pilot pressure	[MPa]	0.25 ... 1	0.25 ... 1	0.25 ... 1	0.25 ... 1	0.15 ... 1	0.25 ... 1
	[bar]	2.5 ... 10	2.5 ... 10	2.5 ... 10	2.5 ... 10	1.5 ... 10	2.5 ... 10
Ambient temperature	[°C]	–10 ... +60					
Temperature of medium	[°C]	–10 ... +60					
Certification		c UL us - Recognized (OL)					
Corrosion resistance class CRC <sup>1)</sup>		2					

1) More information: [www.festo.com/x/topic/kbk](http://www.festo.com/x/topic/kbk)

Information on materials	
Housing	Die-cast aluminium (painted)
Seals	HNBR, NBR
Piston spool	Wrought aluminium alloy
Screws	Galvanised steel
Note on materials	RoHS-compliant

Data sheet

Dimensions

Download CAD data → [www.festo.com](http://www.festo.com)

3/2-way valve, normally closed/open

3/2-way valve, normally closed/open, external pilot air

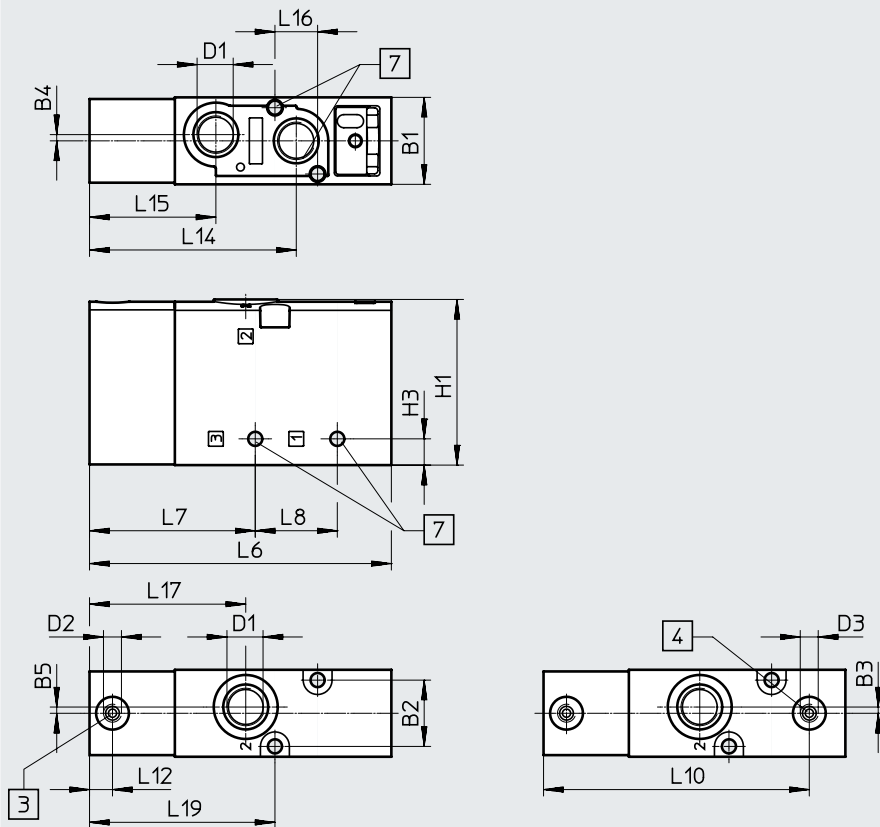

- [3] Port 10: pilot air (...-M32U-...)  
Port 12: pilot air (...-M32C-...)
- [4] Port 10: for external pneumatic spring (...-M32C-E-...)  
Port 12: for external pneumatic spring (...-M32U-E-...)
- [7] For retaining screw M4

Type	B1	B2	B3	B4	B5	D1	D2	D3	H1	H3
VUWS-L25-M32C-...-G14	26.5	20.2	1.9	1.9	1.9	G1/4	M5	-	50.5	8
VUWS-L25-M32U-...-G14								-		
VUWS-L25-M32C-E-...-G14								M5		
VUWS-L25-M32U-E-...-G14								M5		

Type	L6	L7	L8	L10	L12	L14	L15	L16	L17	L19
VUWS-L25-M32C-...-G14	92	50.5	25	-	7	63	38.5	13	47.6	56.5
VUWS-L25-M32U-...-G14				-						
VUWS-L25-M32C-E-...-G14				81						
VUWS-L25-M32U-E-...-G14				81						

Data sheet

Dimensions

Download CAD data → [www.festo.com](http://www.festo.com)

5/2-way valve, monostable

5/2-way valve, monostable, external pilot air

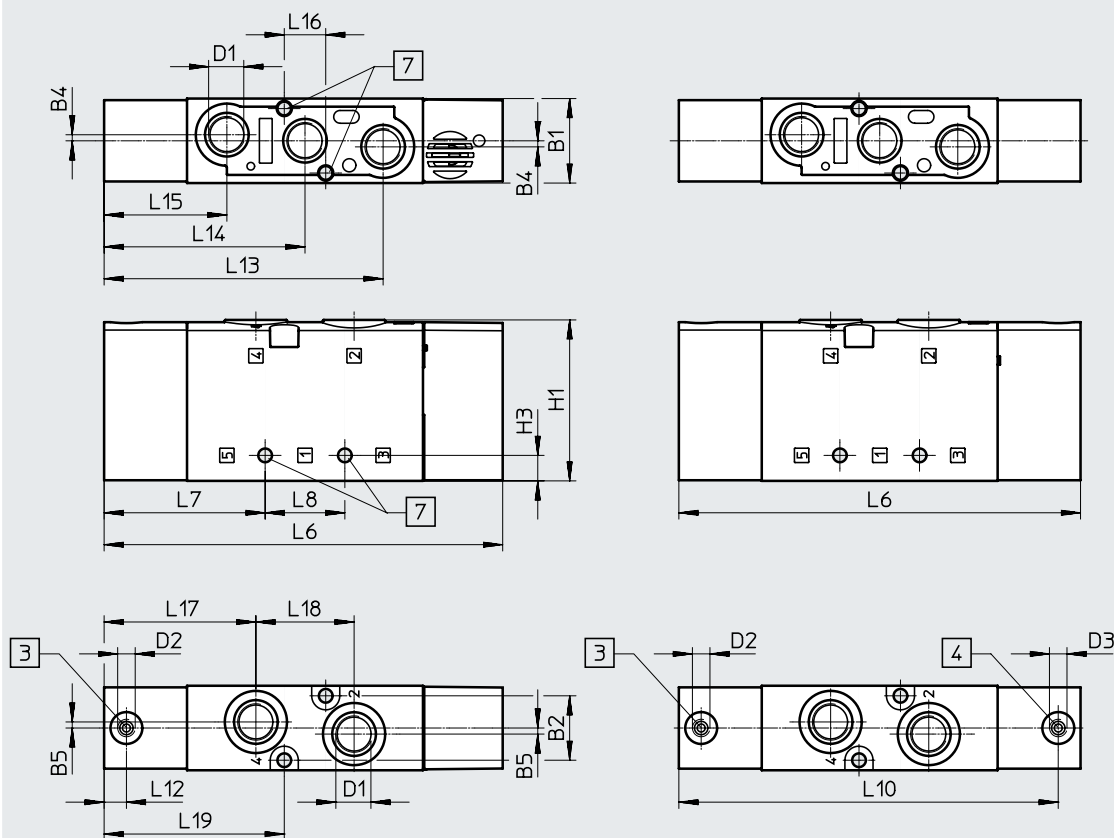

[3] Port 14: pilot air (-M52-...)

[4] Port 12: pilot air/(pneumatic spring) (...M52-E-...)

[7] For retaining screw M4

Type	B1	B2	B4	B5	D1	D2	D3	H1	H3
VUWS-L25-M52-...-G14	26.5	20.2	1.9	1.9	G1/4	M5	-	50.5	8
VUWS-L25-M52-E-G14							M5		

Type	L6	L7	L8	L10	L12	L13	L14	L15	L16	L17	L18	L19
VUWS-L25-M52-...-G14	125	50.5	25	-	7	87.5	63	38.5	13	47.6	30.8	56.5
VUWS-L25-M52-E-G14				119								



Data sheet

Dimensions

Download CAD data → [www.festo.com](http://www.festo.com)

5/2-way valve, bistable, 5/3-way valve

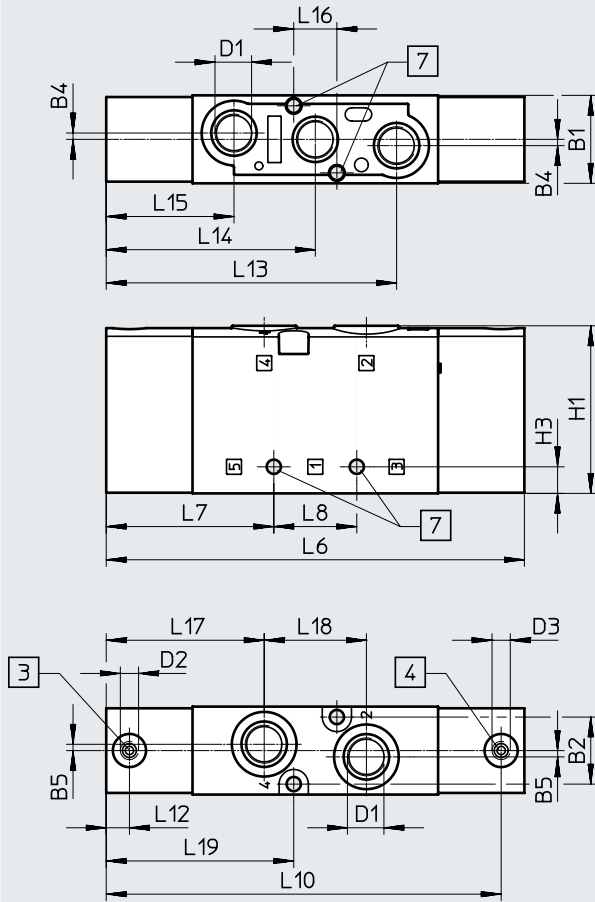

- [3] Port 14: pilot air
- [4] Port 12: pilot air
- [7] For retaining screw M4

Type	B1	B2	B4	B5	D1	D2	D3	H1	H3
VUWS-L25-P53-...-M-G14	26.5	20.2	1.9	1.9	G1/4	M5	M5	50.5	8
VUWS-L25-B52-G14									

  

Type	L6	L7	L8	L10	L12	L13	L14	L15	L16	L17	L18	L19
VUWS-L25-P53-...-M-G14	126	50.5	25	119	7	87.5	63	38.5	13	47.6	30.8	56.5
VUWS-L25-B52-G14												

Data sheet

Dimensions

Foot mounting

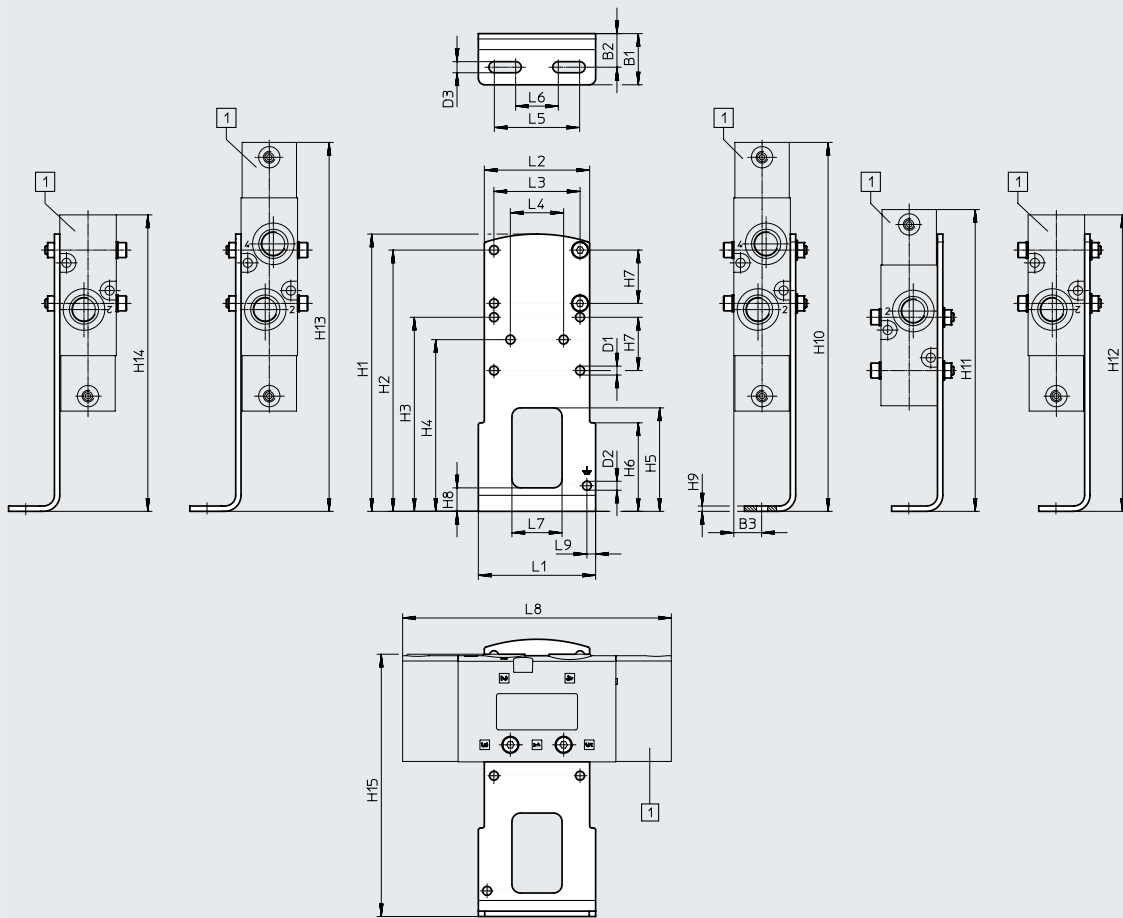

[1] VUWS-L25-B52,  
VUWS-L25-P53,  
VUWS-L25-M52,  
VUWS-L25-M32

Type		B1	B2	B3	D1 ∅	D2 ∅	D3	H1	H2	H3	H4
VAME-B10-25-A	VUWS-L25-B52/P53	24	15.8	13.3	4.2	4.2	5.2	130	122.5	91	80.5
	VUWS-L25-M52-E										
	VUWS-L25-M52										
	VUWS-L25-M32										

Type		H5	H6	H7	H8	H9	H10	H11	H12	H13	H14
VAME-B10-25-A	VUWS-L25-B52/P53	48.5	41.5	25	11	2.5	173	141.5	173	173	173
	VUWS-L25-M52-E										
	VUWS-L25-M52										
	VUWS-L25-M32								139	139	139

Type		H15	L1	L2	L3	L4	L5	L6	L7	L8	L9
VAME-B10-25-A	VUWS-L25-B52/P53	123	55	49.4	40.4	25	40	20	23.5	126	4.1
	VUWS-L25-M52-E										
	VUWS-L25-M52										
	VUWS-L25-M32									92	

Data sheet

Dimensions

Wall mounting

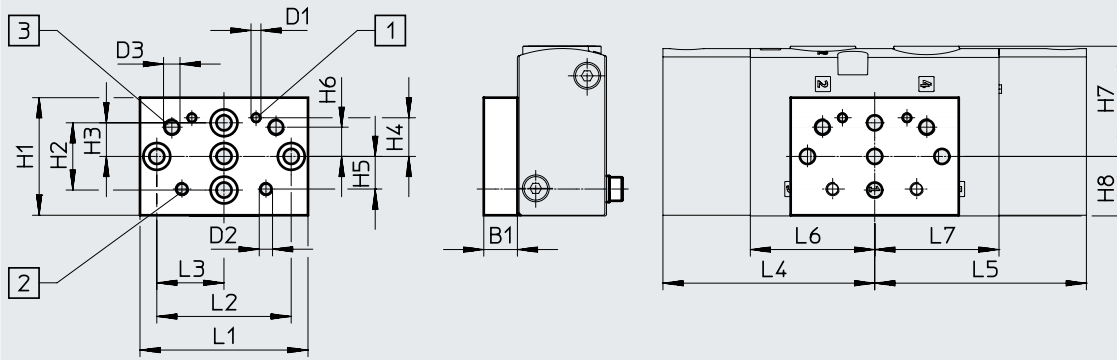

[1] Mounting hole for size 20

[2] Mounting hole for size 25

[3] Mounting hole for size 30



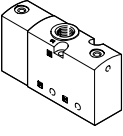
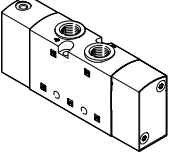
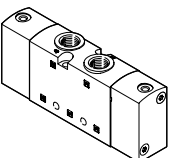

Type		B1	D1	D2	D3	H1	H2	H3	H4	H5	H6
VAME-B10-20-W	VUWS-L25-B52/P53	10	M3	M4	M5	35	20	10	11.5	9.7	8.7
	VUWS-L25-M52-E										
	VUWS-L25-M52										
	VUWS-L25-M32										

Type		H7	H8	L1	L2	L3	L4	L5	L6	L7		
VAME-B10-20-W	VUWS-L25-B52/P53	32.8	17.7	50	40	20	63	63	37	37		
	VUWS-L25-M52-E											
	VUWS-L25-M52										62	-
	VUWS-L25-M32										29	-

## Ordering data

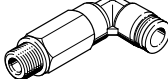
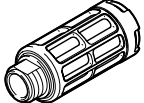
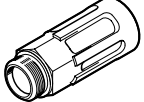

Ordering data – Pneumatic valves				
	Code	Valve function	Part no.	Type
<b>3/2-way valve</b>				
	<b>Normally closed, monostable</b>			
	M32C-A	Reset via pneumatic spring, internal pneumatic spring, flow direction not reversible	575483	VUWS-L25-M32C-A-G14
	M32C-E	Reset via pneumatic spring, external pneumatic spring, flow direction reversible	575484	VUWS-L25-M32C-E-G14
	M32C-M	Reset via mechanical spring, flow direction reversible	575485	VUWS-L25-M32C-M-G14
	<b>Normally open, monostable</b>			
	M32U-A	Reset via pneumatic spring, internal pneumatic spring, flow direction not reversible	575498	VUWS-L25-M32U-A-G14
	M32U-E	Reset via pneumatic spring, external pneumatic spring, flow direction reversible	575499	VUWS-L25-M32U-E-G14
	M32U-M	Reset via mechanical spring, flow direction reversible	575500	VUWS-L25-M32U-M-G14
	<b>5/2-way valve</b>			
	<b>Monostable</b>			
	M52-A	Reset via pneumatic spring, internal pneumatic spring, flow direction not reversible	575507	VUWS-L25-M52-A-G14
	M52-E	Reset via pneumatic spring, external pneumatic spring, flow direction reversible	575508	VUWS-L25-M52-E-G14
	M52-M	Reset via mechanical spring, flow direction reversible	575515	VUWS-L25-M52-M-G14
	<b>Bistable</b>			
	B52	Flow direction reversible	575522	VUWS-L25-B52-G14
<b>5/3-way valve</b>				
	<b>Mid-position closed</b>			
	P53C	Reset via mechanical spring, flow direction reversible	575529	VUWS-L25-P53C-M-G14
	<b>Mid-position exhausted</b>			
	P53E	Reset via mechanical spring, flow direction reversible	575543	VUWS-L25-P53E-M-G14
	<b>Mid-position pressurised</b>			
P53U	Reset via mechanical spring, flow direction reversible	575536	VUWS-L25-P53U-M-G14	

## Accessories

Ordering data		Description	Part no.	Type	PU <sup>1)</sup>
<b>Push-in fitting with internal hex</b>					
	Connecting thread M5 for tubing O.D.	4 mm	153315	QSM-M5-4-I	10
	Connecting thread G1/4 for tubing O.D.	6 mm	186108	QS-G1/4-6-I	10
		8 mm	186110	QS-G1/4-8-I	10
		10 mm	186112	QS-G1/4-10-I	10
<b>Angled push-in fitting with external hex</b>					
	Connecting thread G1/4 for tubing O.D.	6 mm	186118	QSL-G1/4-6	10
			132051	QSL-G1/4-6-100	100
		8 mm	186120	QSL-G1/4-8	10
			132052	QSL-G1/4-8-50	50
		10 mm	186122	QSL-G1/4-10	10
			132053	QSL-G1/4-10-50	50
<b>Angled push-in fitting, long, with external hex</b>					
	Connecting thread G1/4 for tubing O.D.	6 mm	186129	QSL-G1/4-6	10
		8 mm	186131	QSL-G1/4-8	10
		10 mm	186133	QSL-G1/4-10	10
<b>Silencer</b>					
	With connecting thread G, polymer design	G1/4	2316	U-1/4	1
			534223	U-1/4-20	20
	With connecting thread G, metal design	G1/4	6842	U-1/4-B	1
	With connecting thread G, sintered design, long	G1/4	1205861	AMTE-M-LH-G14	20

1) Packaging unit

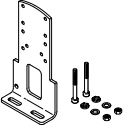
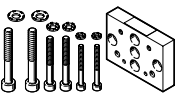
## Accessories

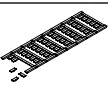
Ordering data	Description	Weight [g]	Part no.	Type
<b>Foot mounting</b>				
	Set for mounting valves, comprising: <ul style="list-style-type: none"> <li>• Mounting bracket and</li> <li>• Screw set for mounting</li> </ul>	130	2293485	VAME-B10-25-A
<b>Wall mounting</b>				
	Set for mounting valves for size 20, 25, 30, comprising: <ul style="list-style-type: none"> <li>• Wall mounting and</li> <li>• Screw set for mounting</li> </ul>	53	576413	VAME-B10-20-W
<b>Assortment of spare parts</b>				
	Set comprising: <ul style="list-style-type: none"> <li>• Seals and</li> <li>• Screws</li> </ul>	12	8035636	VAME-B10-25-MK
<b>Inscription label</b>				
	40 pieces in frame	-	565306	ASLR-C-E4

## Data sheet

-  - Flow rate  
up to 2300 l/min

-  - Valve width  
31 mm

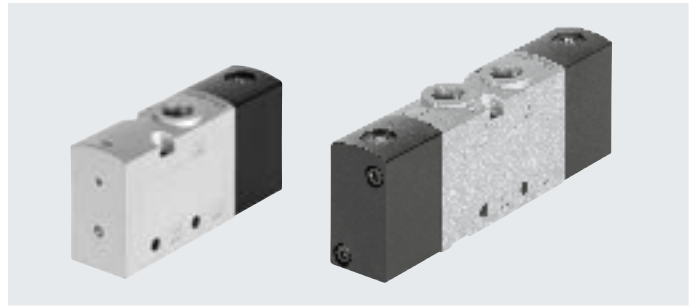

## General technical data

Valve function	3/2			5/2		5/3		
Order code for valves	M32C	M32U	M52	B52	P53C	P53U	P53E	
Valve width [mm]	31							
Design	Piston spool							
Pneumatic spring supply	Internal or external (external: identified by E in type code)							
Type of control	Direct							
Manual override (MO)	None							
Flow direction	Reversible with restrictions (not reversible: identified by A in type code)							
Overlap	Positive overlap							
Sealing principle	Soft							
Type of mounting	Optionally via through-holes <sup>1)</sup> or on manifold rail							
Standard nominal flow rate qnN [l/min]	2300	2300	2300	2300	2000	1600	1600	
Through-holes (nominal width) [mm]	9.4	9.4	9.4	9.4	8.9	8.1	8.1	
Product weight [g]	394	394	487/546 <sup>2)</sup>	545	542	542	542	
Type of actuation	Pneumatic							
Mounting position	Any							
Exhaust function	Can be throttled							
Venting hole	Not ducted							
Pneumatic connection	1, 2, 3	G3/8	G3/8	G3/8	G3/8	G3/8	G3/8	G3/8
	4, 5	-	-	G3/8	G3/8	G3/8	G3/8	G3/8
Pneumatic spring connection 12/14, 10	G1/8							

1) If several valves are to be screwed together via through-holes to form a block, a minimum distance of 0.3 mm must be ensured by placing spacer discs between them.

2) With external pneumatic spring: 546 g, with internal pneumatic spring or mechanical spring: 487 g

## Technical data – 3/2-way valves

Order code for valves	M32C-A	M32C-E	M32C-M	M32U-A	M32U-E	M32U-M
Normal position	Closed			Open		
Stable position	Monostable			Monostable		
Reset method	Pneumatic spring		Mechanical spring	Pneumatic spring		Mechanical spring
Switching times in [ms]	On	19	21	16	19	21
	Off	36	40	73	37	40

## Data sheet

Technical data – 5/2-way valves			
Order code for valves		M52	B52
Stable position		Monostable	
Reset method		Pneumatic spring	Mechanical spring
Switching times in [ms]	On	24	17
	Off	59	77
	Change-over	–	–
			13

Technical data – 5/3-way valves				
Order code for valves		P53C	P53U	P53E
Stable position		Monostable		
Reset method		Mechanical spring		
Switching times in [ms]	On	19	19	19
	Off	98	98	98
	Change-over	41	41	41

Safety characteristics	
Shock resistance	Shock test with severity level 2 to FN 942017-5 and EN 60068-2-27
Vibration resistance	Transport application test with severity level 2 to FN 942017-4 and EN 60068-2-6

Operating and environmental conditions							
Valve function		M32 ... A M32 ... M	M32 ... E	M52-A	M52-E M52-M	B52	P53
Operating medium		Compressed air to ISO 8573-1:2010 [7:4:4]					
Pilot medium		Compressed air to ISO 8573-1:2010 [7:4:4]					
Note on the operating/pilot medium		Lubricated operation possible (in which case lubricated operation will always be required)					
Operating pressure	[MPa]	–0.09 ... +1	–0.09 ... +1	0.25 ... 1	–0.09 ... +1	–0.09 ... +1	–0.09 ... +1
	[bar]	–0.9 ... +10	–0.9 ... +10	2.5 ... 10	–0.9 ... +10	–0.9 ... +10	–0.9 ... +10
Pilot pressure	[MPa]	0.25 ... 1	0.25 ... 1	0.25 ... 1	0.25 ... 1	0.15 ... 1	0.25 ... 1
	[bar]	2.5 ... 10	2.5 ... 10	2.5 ... 10	2.5 ... 10	1.5 ... 10	2.5 ... 10
Ambient temperature	[°C]	–10 ... +60					
Temperature of medium	[°C]	–10 ... +60					
Certification		c UL us - Recognized (OL)					
Corrosion resistance class CRC <sup>1)</sup>		2					

1) More information: [www.festo.com/x/topic/kbk](http://www.festo.com/x/topic/kbk)

Information on materials	
Housing	Die-cast aluminium (painted)
Seals	HNBR, NBR
Piston spool	Wrought aluminium alloy
Screws	Nickel-plated steel
Note on materials	RoHS-compliant



Data sheet

Dimensions

Download CAD data → [www.festo.com](http://www.festo.com)

3/2-way valve, normally closed/open

3/2-way valve, normally closed/open, external pilot air

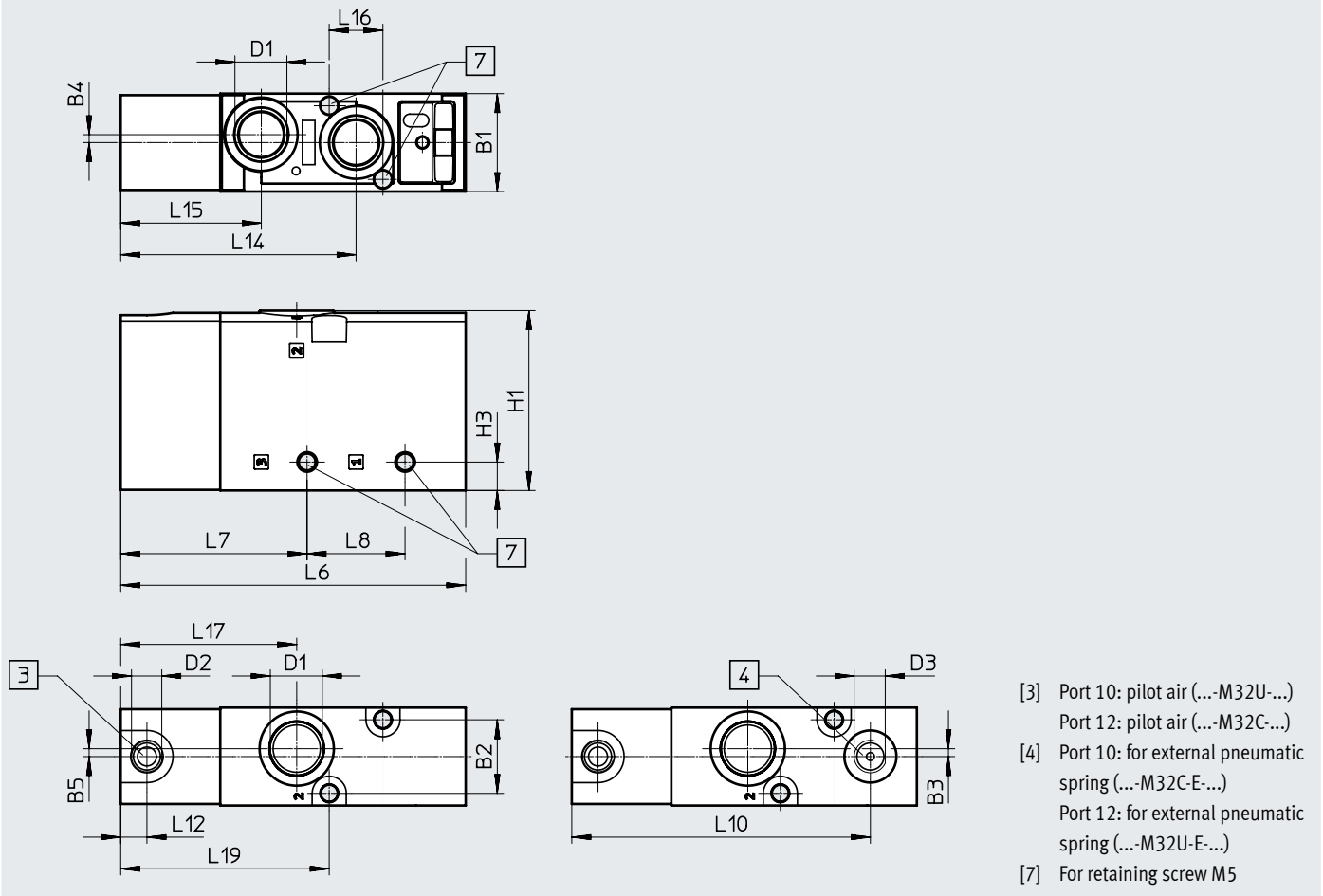

- [3] Port 10: pilot air (...-M32U-...)  
Port 12: pilot air (...-M32C-...)
- [4] Port 10: for external pneumatic spring (...-M32C-E-...)  
Port 12: for external pneumatic spring (...-M32U-E-...)
- [7] For retaining screw M5

Type	B1	B2	B3	B4	B5	D1	D2	D3	H1	H3
VUWS-L30-M32C-...-G38	31	23.3	2.5	2.5	2.5	G3/8	G1/8	-	57	9
VUWS-L30-M32U-...-G38								-		
VUWS-L30-M32C-E-...-G38								G1/8		
VUWS-L30-M32U-E-...-G38								G1/8		

Type	L6	L7	L8	L10	L12	L14	L15	L16	L17	L19
VUWS-L30-M32C-...-G38	109.2	59	31	-	8.3	74.5	44.5	17	55.7	66
VUWS-L30-M32U-...-G38				-						
VUWS-L30-M32C-E-...-G38				94.5						
VUWS-L30-M32U-E-...-G38				94.5						

Data sheet

Dimensions

Download CAD data → [www.festo.com](http://www.festo.com)

5/2-way valve, monostable

5/2-way valve, monostable, external pilot air

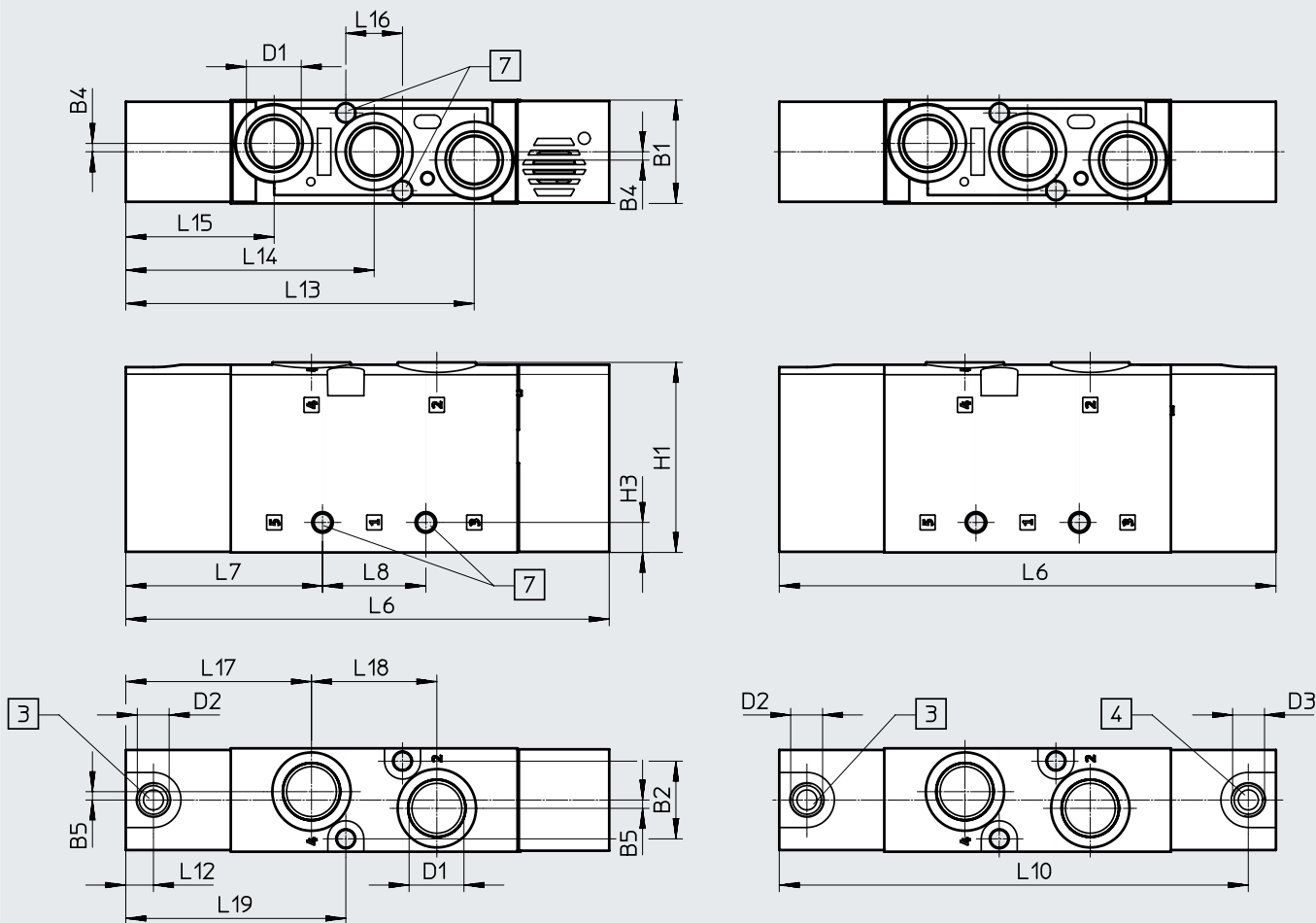

[3] Port 14: pilot air (-M52-...)

[4] Port 12: pilot air/(pneumatic spring) (...M52-E-...)

[7] For retaining screw M5

Type	B1	B2	B4	B5	D1	D2	D3	H1	H3
VUWS-L30-M52-...-G38	31	23.3	2.5	2.5	G3/8	G1/8	-	57	9
VUWS-L30-M52-E-G38							G1/8		

Type	L6	L7	L8	L10	L12	L13	L14	L15	L16	L17	L18	L19
VUWS-L30-M52-...-G38	145	59	31	-	8.3	104.5	74.5	44.5	17	55.7	37.6	66
VUWS-L30-M52-E-G38	149			140.7								

Data sheet

Dimensions

Download CAD data → [www.festo.com](http://www.festo.com)

5/2-way valve, bistable, 5/3-way valve

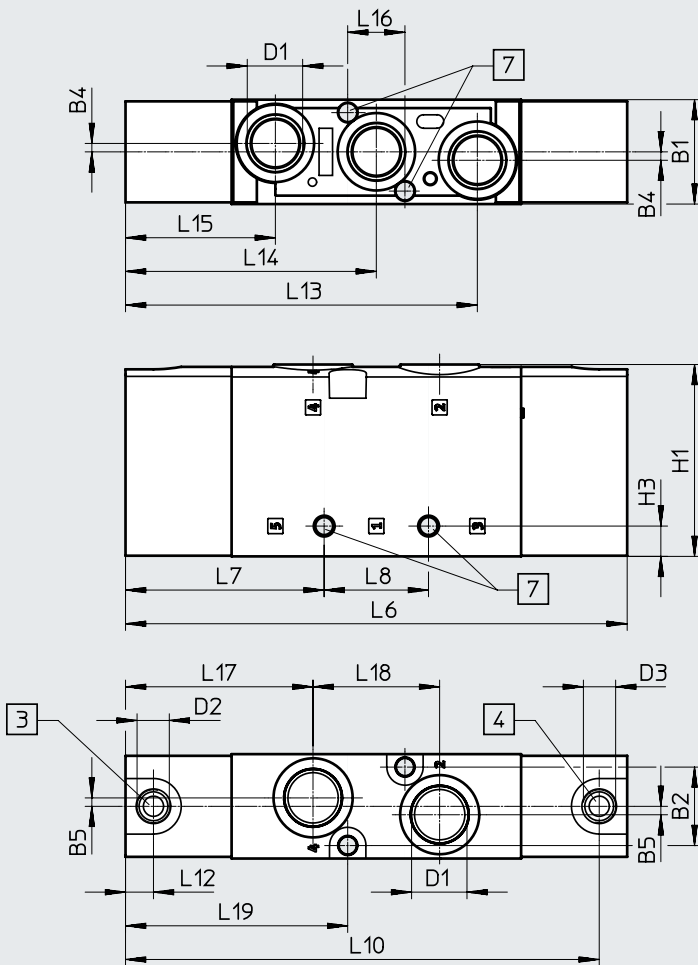

- [3] Port 14: pilot air
- [4] Port 12: pilot air
- [7] For retaining screw M5

Type	B1	B2	B4	B5	D1	D2	D3	H1	H3
VUWS-L30-P53-....-M-G38	31	23.3	2.5	2.5	G3/8	G1/8	G1/8	57	9
VUWS-L30-B52-G38									

Type	L6	L7	L8	L10	L12	L13	L14	L15	L16	L17	L18	L19
VUWS-L30-P53-....-M-G38	149	59	31	140.7	8.3	104.5	74.5	44.5	17	55.7	37.6	66
VUWS-L30-B52-G38												

Data sheet

Dimensions

Foot mounting

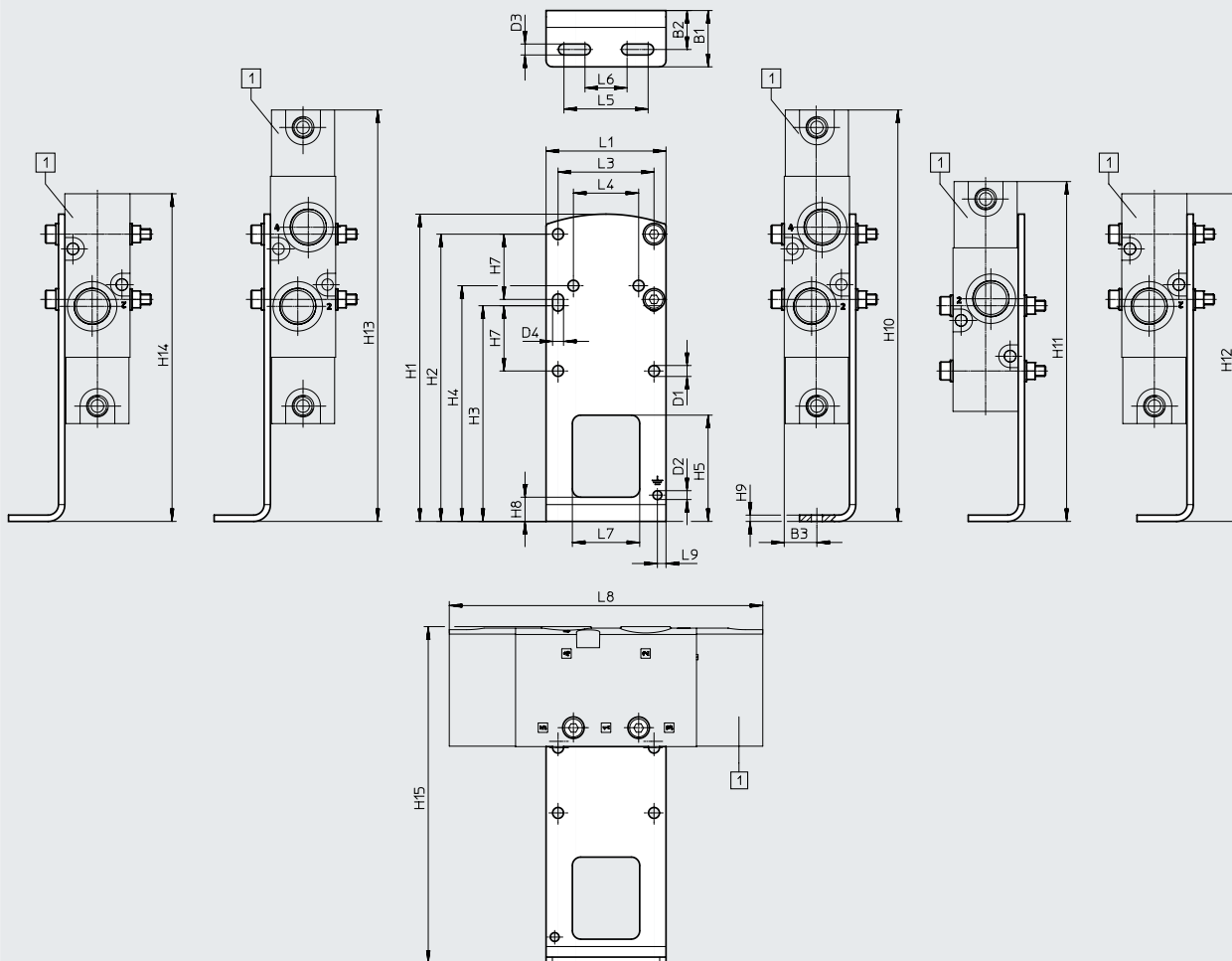

[1] VUWS-L30-B52,  
VUWS-L30-P53,  
VUWS-L30-M52,  
VUWS-L30-M32

Type		B1	B2	B3	D1 ∅	D2 ∅	D3	D4	H1	H2	H3
VAME-B10-30-A	VUWS-L30-B52/P53	26.8	18.5	15.5	5.2	4.2	5.2	5.2	146	136.5	102.5
	VUWS-L30-M52-E										
	VUWS-L30-M52										
	VUWS-L30-M32										

Type		H4	H5	H7	H8	H9	H10	H11	H12	H13	H14
VAME-B10-30-A	VUWS-L30-B52/P53	112	50.5	31	11.5	3	195.5	161.5	195.5	195.5	195.5
	VUWS-L30-M52-E										
	VUWS-L30-M52							197.2	191.5		191.5
	VUWS-L30-M32							155.7	155.7		155.7

Type		H15	L1	L3	L4	L5	L6	L7	L8	L9	
VAME-B10-30-A	VUWS-L30-B52/P53	160	57	45.6	31	40	20	32	149	4.1	
	VUWS-L30-M52-E										
	VUWS-L30-M52										145
	VUWS-L30-M32										109.2

Data sheet

Dimensions

Wall mounting

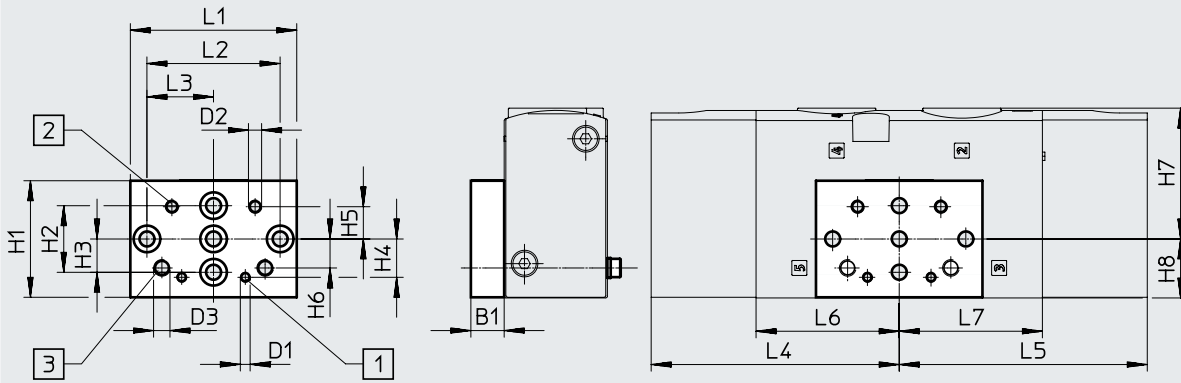

[1] Mounting hole for size 20

[2] Mounting hole for size 25

[3] Mounting hole for size 30



Type		B1	D1	D2	D3	H1	H2	H3	H4	H5	H6
VAME-B10-20-W	VUWS-L30-B52/P53	10	M3	M4	M5	35	20	10	11.5	9.7	8.7
	VUWS-L30-M52										
	VUWS-L30-M32										

Type		H7	H8	L1	L2	L3	L4	L5	L6	L7	
VAME-B10-20-W	VUWS-L30-B52/P53	39.3	17.7	50	40	20	74.5	74.5	43	43	
	VUWS-L30-M52										70.5
	VUWS-L30-M32										34.7

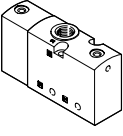
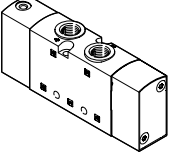
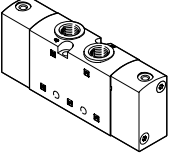
## Ordering data

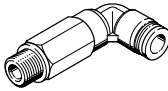
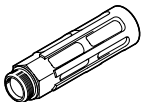

Ordering data – Pneumatic valves				
	Code	Valve function	Part no.	Type
<b>3/2-way valve</b>				
	<b>Normally closed, monostable</b>			
	M32C-A	Reset via pneumatic spring, internal pneumatic spring, flow direction not reversible	575576	VUWS-L30-M32C-A-G38
	M32C-E	Reset via pneumatic spring, external pneumatic spring, flow direction reversible	575577	VUWS-L30-M32C-E-G38
	M32C-M	Reset via mechanical spring, flow direction reversible	575578	VUWS-L30-M32C-M-G38
	<b>Normally open, monostable</b>			
	M32U-A	Reset via pneumatic spring, internal pneumatic spring, flow direction not reversible	575591	VUWS-L30-M32U-A-G38
	M32U-E	Reset via pneumatic spring, external pneumatic spring, flow direction reversible	575592	VUWS-L30-M32U-E-G38
	M32U-M	Reset via mechanical spring, flow direction reversible	575593	VUWS-L30-M32U-M-G38
	<b>5/2-way valve</b>			
	<b>Monostable</b>			
	M52-A	Reset via pneumatic spring, internal pneumatic spring, flow direction not reversible	575600	VUWS-L30-M52-A-G38
	M52-E	Reset via pneumatic spring, external pneumatic spring, flow direction reversible	575601	VUWS-L30-M52-E-G38
	M52-M	Reset via mechanical spring, flow direction reversible	575608	VUWS-L30-M52-M-G38
	<b>Bistable</b>			
	B52	Flow direction reversible	575615	VUWS-L30-B52-G38
<b>5/3-way valve</b>				
	<b>Mid-position closed</b>			
	P53C	Reset via mechanical spring, flow direction reversible	575622	VUWS-L30-P53C-M-G38
	<b>Mid-position exhausted</b>			
	P53E	Reset via mechanical spring, flow direction reversible	575636	VUWS-L30-P53E-M-G38
	<b>Mid-position pressurised</b>			
P53U	Reset via mechanical spring, flow direction reversible	575629	VUWS-L30-P53U-M-G38	

## Accessories

Ordering data		Description	Part no.	Type	PU <sup>1)</sup>
<b>Push-in fitting with internal hex</b>					
	Connecting thread G1/8 for tubing O.D.	4 mm	186106	QS-G1/8-4-I	10
			133008	QS-G1/8-4-I-100	100
		6 mm	186107	QS-G1/8-6-I	10
			133009	QS-G1/8-6-I-100	100
	Connecting thread G3/8 for tubing O.D.	8 mm	186111	QS-G3/8-8-I	10
		10 mm	186113	QS-G3/8-10-I	10
12 mm		186114	QS-G3/8-12-I	10	
<b>Angled push-in fitting with external hex</b>					
	Connecting thread G3/8 for tubing O.D.	8 mm	186121	QSL-G3/8-8	10
			132055	QSL-G3/8-8-50	50
		10 mm	186123	QSL-G3/8-10	10
			132056	QSL-G3/8-10-20	20
		12 mm	186124	QSL-G3/8-12	10
			132057	QSL-G3/8-12-20	20
<b>Angled push-in fitting, long, with external hex</b>					
	Connecting thread G3/8 for tubing O.D.	8 mm	186132	QSL-G3/8-8	10
		10 mm	186134	QSL-G3/8-10	10
		12 mm	186135	QSL-G3/8-12	10
<b>Silencer</b>					
	With connecting thread G, metal design	G3/8	6843	U-3/8-B	1

1) Packaging unit

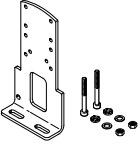
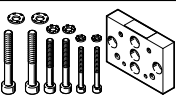
## Accessories

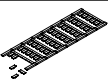
Ordering data	Description	Weight [g]	Part no.	Type
<b>Foot mounting</b>				
	Set for mounting valves, comprising: <ul style="list-style-type: none"> <li>• Mounting bracket and</li> <li>• Screw set for mounting</li> </ul>	–	<b>8026337</b>	<b>VAME-B10-30-A</b>
<b>Wall mounting</b>				
	Set for mounting valves for size 20, 25, 30, comprising: <ul style="list-style-type: none"> <li>• Wall mounting and</li> <li>• Screw set for mounting</li> </ul>	53	<b>576413</b>	<b>VAME-B10-20-W</b>
<b>Assortment of spare parts</b>				
	Set comprising: <ul style="list-style-type: none"> <li>• Seals and</li> <li>• Screws</li> </ul>	–	<b>8035637</b>	<b>VAME-B10-30-MK</b>
<b>Inscription label</b>				
	40 pieces in frame	–	<b>565306</b>	<b>ASLR-C-E4</b>



## Data sheet – Manifold block, size 20

-  - Flow rate  
up to 700 l/min

-  - Valve width  
21 mm

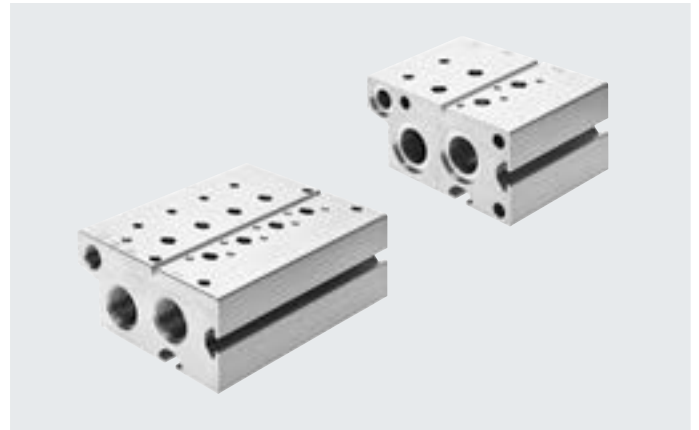
**General technical data**

	Manifold block standard		Extension module for standard manifold block		Manifold block compact		Common supply manifold	
	3/2	5/2, 5/3	3/2	5/2, 5/3	3/2	5/2, 5/3	On both sides	On one side
Valve function	3/2	5/2, 5/3	3/2	5/2, 5/3	3/2	5/2, 5/3	3/2, 5/2, 5/3	
Grid dimension [mm]	22							
Type of mounting	Via through-hole						Via mounting bracket	
Max. number of valve positions	10	10	2	2	10		10	4
Port 1	G3/8	G3/8	G3/8	G3/8	G1/4	G1/4	G3/8	G3/8
Port 3	G3/8	G3/8	G3/8	G3/8	G1/4	G1/4	-	-
Port 5	-	G3/8	-	G3/8	-	G1/4	-	-
Port 12	G1/8	G1/8	G1/8	G1/8	-	-	-	-
Port 14	-	G1/8	-	G1/8	-	-	-	-
CRC <sup>1)</sup>	2 <sup>1)</sup>							

1) More information: [www.festo.com/x/topic/kbk](http://www.festo.com/x/topic/kbk)

**Weight [g]**

Valve positions	2	3	4	5	6	7	8	9	10
<b>Manifold block for 3/2-way valves, standard</b>									
VABM-B10-20E-G38-...-P3	449	574	699	825	950	1075	1200	1326	1451
<b>Manifold block, extension module for 3/2-way valves, standard</b>									
VABM-B10-20EEE-G38-2-P3	324	-	-	-	-	-	-	-	-
<b>Manifold block for 5/2- and 5/3-way valves, standard</b>									
VABM-B10-20E-G38-...	680	866	1053	1239	1425	1612	1798	1985	2171
<b>Manifold block, extension module for 5/2- and 5/3-way valves, standard</b>									
VABM-B10-20EEE-G38-2	492	-	-	-	-	-	-	-	-
<b>Manifold block for 3/2-way valves, compact</b>									
VABM-B10-20S-G14-...-P3	280	360	441	521	601	681	762	842	922
<b>Manifold block for 5/2- and 5/3-way valves, compact</b>									
VABM-B10-20S-G14-...	344	439	535	630	726	821	917	1012	1108
<b>Common supply manifold for mounting on both sides</b>									
VABM-B10-20-G38-...-P53	226	268	310	352	395	437	479	521	563
<b>Common supply manifold for mounting on one side</b>									
VABM-B10-20-G38-...-P53-E	240	282	324	-	-	-	-	-	-

**Information on materials**

Information on materials	Wrought aluminium alloy
Note on materials	RoHS-compliant

Data sheet – Manifold block, size 20

**Dimensions**

Manifold block for 3/2-way valves, standard

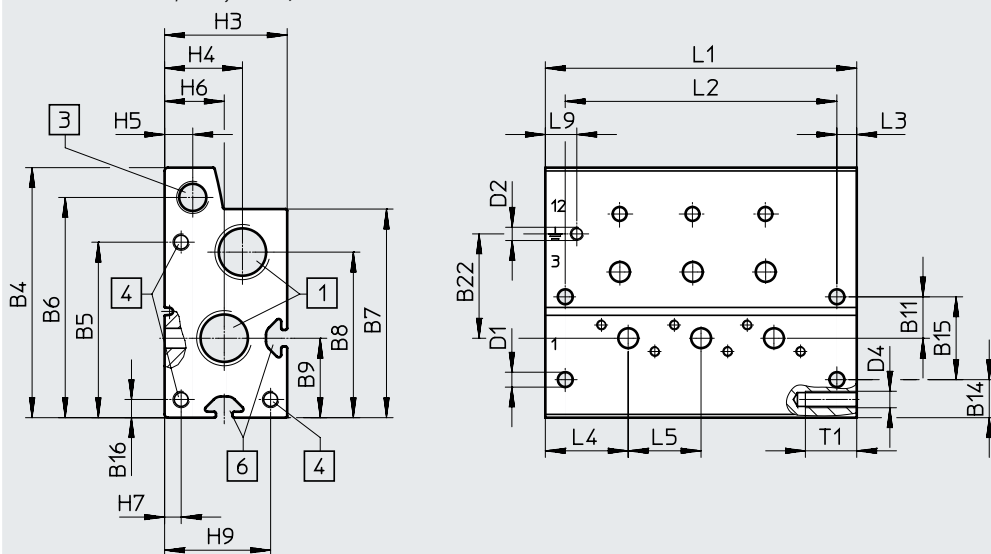

[1] Ports 1 and 3 (at both ends): G3/8

[3] Port 12 (at both ends): G1/8

[4] Thread M5x15.5 for extension module

[6] Profile slot IPM-05, system 5

Type	B4	B5	B6	B7	B8	B9	B11	B14	B15	B16	B22
VABM-B10-20E-G38-...-P3	75.5	53	66.5	63	50	24	12.5	11.5	25	5.5	31.5

Type	D1 ø	D2	D4	H3	H4	H5	H6	H7	H9	L3	L4	L5	L9	T1
VABM-B10-20E-G38-...-P3	4.5	M4x6.5	M5	37	23.5	8.5	18	5	32	6	25	22	9.5	15.5

Valve positions	2	3	4	5	6	7	8	9	10
L1 [mm]	72	94	116	138	160	182	204	226	248
L2 [mm]	60	82	104	126	148	170	192	214	236

## Data sheet – Manifold block, size 20

### Dimensions

Manifold block, extension module for 3/2-way valves, standard

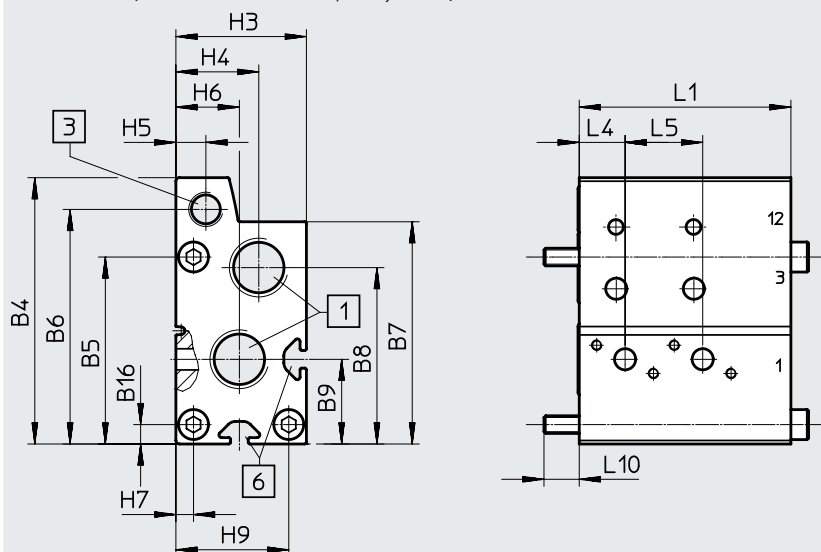

[1] Ports 1 and 3; threaded connection G3/8 at one end

[3] Threaded connection at port 12: G1/8 at one end

[6] Profile slot IPM-05, system 5

Type	B4	B5	B6	B7	B8	B9	B16	H3	H4	H5	H6	H7	H9	L4	L5	L10
VABM-B10-20EEE-G38-2-P3	75.5	53	66.5	63	50	24	5.5	37	23.5	8.5	18	5	32	13	22	10
Valve positions	2															
L1 [mm]	60															

Data sheet – Manifold block, size 20

**Dimensions**

Manifold block for 5/2- and 5/3-way valves, standard

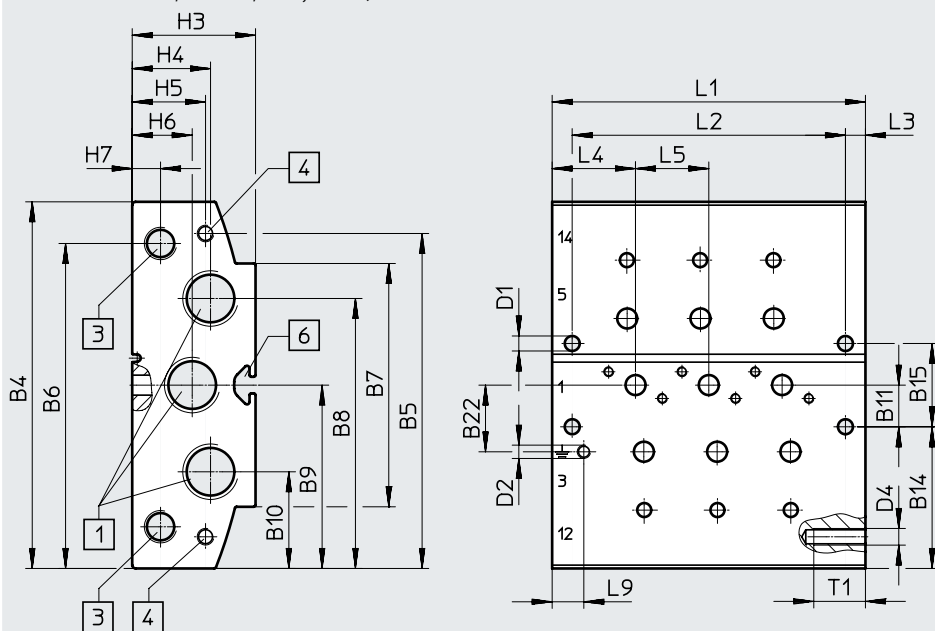

- [1] Ports 1, 3 and 5 (at both ends): G3/8
- [2] Ports 2, 4 and 6 (at both ends): G3/8
- [3] Ports 12 and 14 (at both ends): G1/8
- [4] Thread M5x15.5 for extension module
- [5] Thread M5x15.5 for extension module
- [6] Profile slot IPM-05, system 5

Type	B4	B5	B6	B7	B8	B9	B10	B11	B14	B15	B22
VABM-B10-20E-G38-...	110	100.5	97.5	73	81	55	29	12.5	42.5	25	20

Type	D1 ø	D2	D4	H3	H4	H5	H6	H7	L3	L4	L5	L9	T1
VABM-B10-20E-G38-...	4.5	M4x6.5	M5	37	23.5	22	18	8.5	6	25	22	9.5	15.5

Valve positions	2	3	4	5	6	7	8	9	10
L1 [mm]	72	94	116	138	160	182	204	226	248
L2 [mm]	60	82	104	126	148	170	192	214	236

## Data sheet – Manifold block, size 20

### Dimensions

Manifold block, extension module for 5/2- and 5/3-way valves, standard

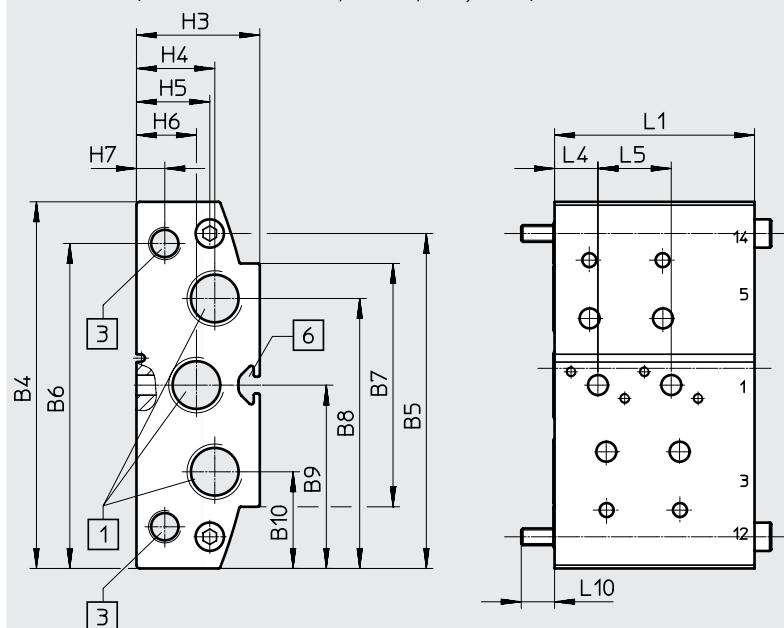

[1] Ports 1, 3 and 5; threaded connection G3/8 at one end

[3] Threaded connection at ports 12 and 14: G1/8 at one end

[6] Profile slot IPM-05, system 5

Type	B4	B5	B6	B7	B8	B9	B10	H3	H4	H5	H6	H7	L4	L5	L10
VABM-B10-20EEE-G38-2	110	100.5	97.5	73	81	55	29	37	23.5	22	18	8.5	13	22	10
Valve positions	2														
L1 [mm]	60														

Data sheet – Manifold block, size 20

**Dimensions**

Manifold block for 3/2-way valves, compact

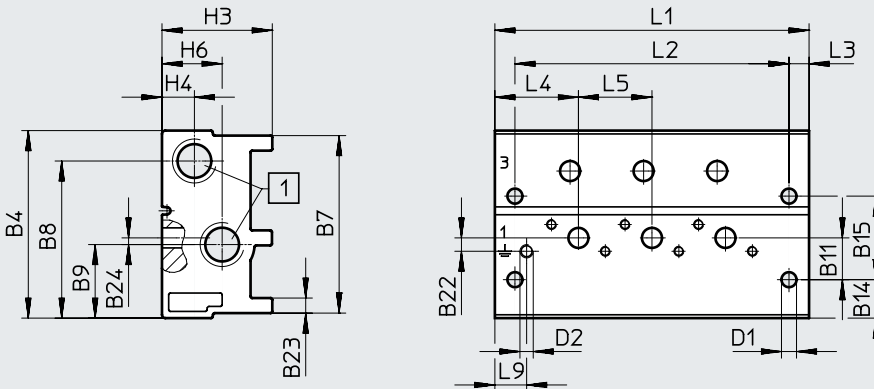

[1] Ports 1 and 3 (at both ends):  
G1/4

Type	B4	B7	B8	B9	B11	B14	B15	B22	B23	B24
VABM-B10-20S-G14-...-P3	56.1	53.1	471	22	12.5	11.5	25	4	5	2

Type	D1 ø	D2	H3	H4	H6	L3	L4	L5	L9
VABM-B10-20S-G14-...-P3	4.5	M4x6.5	33	9.7	18	6	25	22	9.5

Valve positions	2	3	4	5	6	7	8	9	10
L1 [mm]	72	94	116	138	160	182	204	226	248
L2 [mm]	60	82	104	126	148	170	192	214	236

**Dimensions**

Manifold block for 5/2- and 5/3-way valves, compact

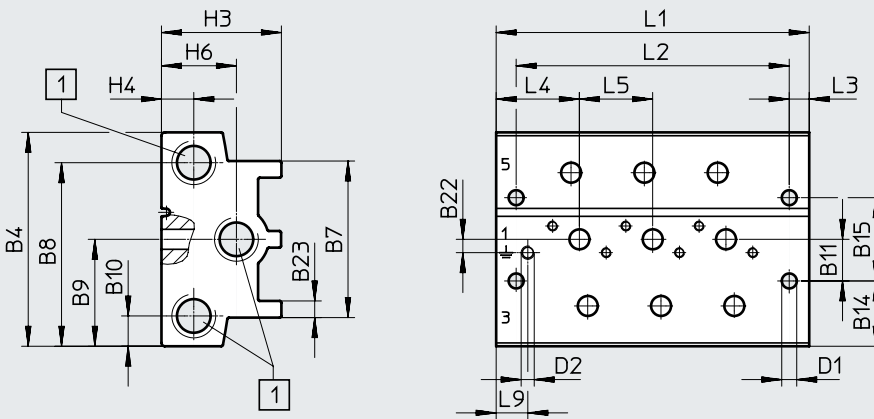

[1] Ports 1, 3 and 5 (at both ends):  
G1/4

Type	B4	B7	B8	B9	B10	B11	B14	B15	B22	B23
VABM-B10-20S-G14-...	64.2	47	55.1	32.1	9.1	12.5	149.6	25	4	5

Type	D1 ø	D2	H3	H4	H6	L3	L4	L5	L9
VABM-B10-20S-G14-...	4.5	M4x6.5	36	9.7	22.5	6	25	22	9.5

Valve positions	2	3	4	5	6	7	8	9	10
L1 [mm]	72	94	116	138	160	182	204	226	248
L2 [mm]	60	82	104	126	148	170	192	214	236

### Data sheet – Manifold block, size 20

#### Dimensions

Common supply manifold, mounting on both sides

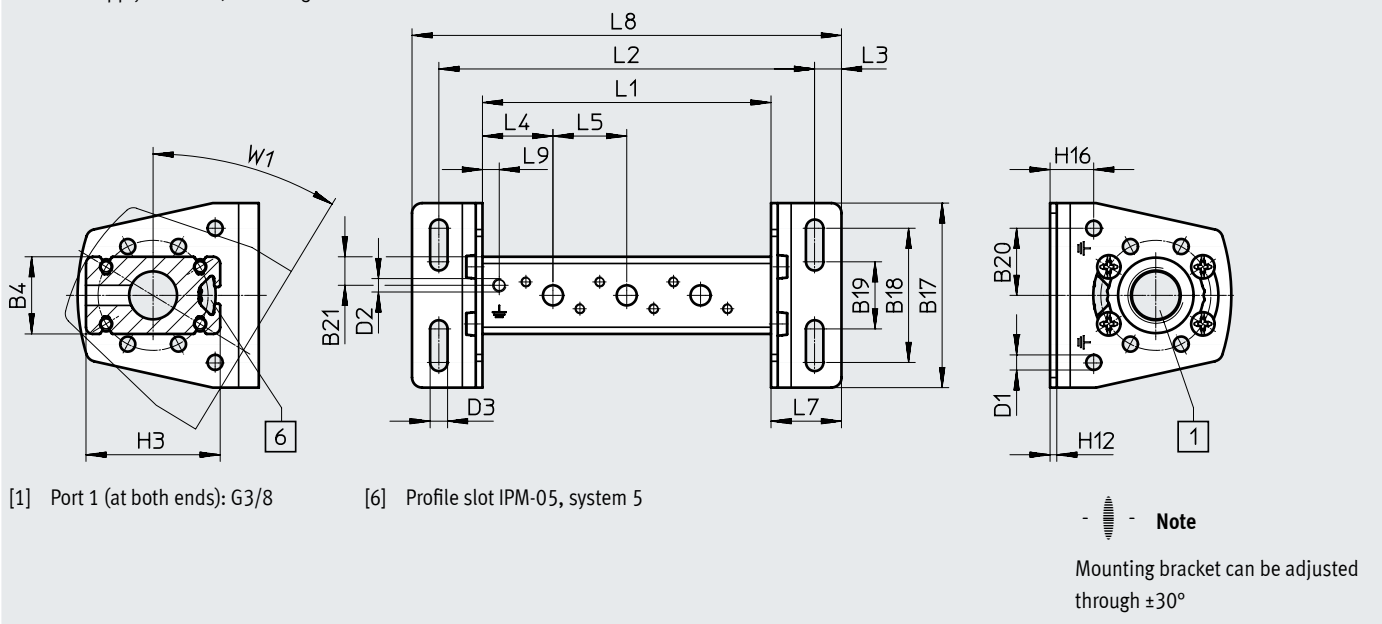

Type	B4	B17	B18	B19	B20	B21	D1 ø	D2	D3 ø	H3	H12	H16	L3	L4	L5	L7	L9	W1
VABM-B10-20-G38...-P53	23	55	40	20	20	8.5	4.5	M4x6.5	5.2	40	2	13	9	21	22	22	5	31.3°

Valve positions	2	3	4	5	6	7	8	9	10
L1 [mm]	64	86	108	130	152	174	196	218	240
L2 [mm]	90	112	134	156	178	200	222	244	266
L8 [mm]	106	128	150	172	194	216	238	260	282

#### Dimensions



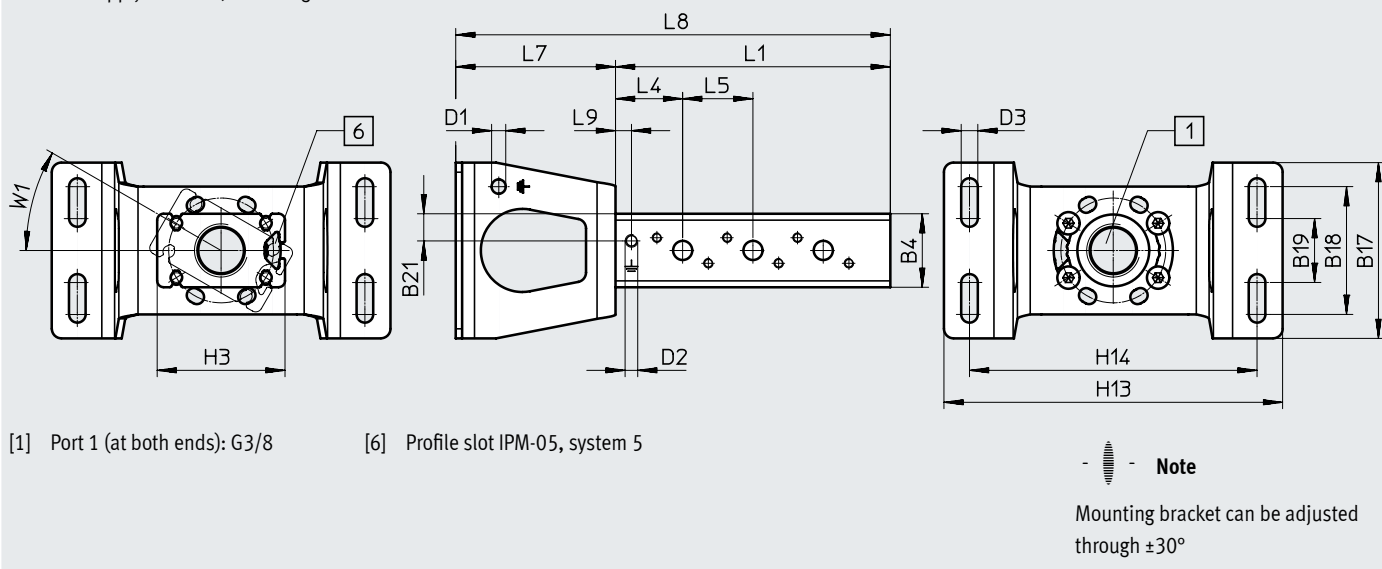





Common supply manifold, mounting on one side

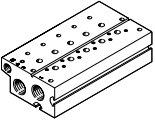

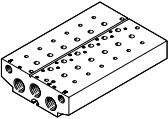
Type	B4	B17	B18	B19	B21	D1 ø	D2	D3 ø	H3	H13	H14	L4	L5	L7	L9	W1
VABM-B10-20-G38...-P53-E	23	55	40	20	8.5	4.5	M4x6.5	5.2	40	106	90	21	22	50	5	30°

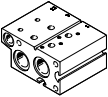
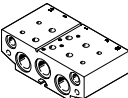
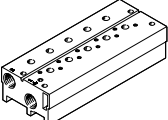
Valve positions	2	3	4
L1 [mm]	64	86	108
L8 [mm]	114	136	158

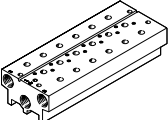
Ordering data – Manifold block, size 20

Ordering data	Description	Valve positions	Part no.	Type
<b>Standard manifold block</b>				
	For 3/2-way valves, incl. seals and screws for mounting valves  -  - <b>Note</b> Blanking plugs for sealing the supply ports (1, 3 and 14) at one end are included in the scope of delivery.	2	576441	VABM-B10-20E-G38-2-P3
		3	576442	VABM-B10-20E-G38-3-P3
		4	576443	VABM-B10-20E-G38-4-P3
		5	576444	VABM-B10-20E-G38-5-P3
		6	576445	VABM-B10-20E-G38-6-P3
		7	576446	VABM-B10-20E-G38-7-P3
		8	576447	VABM-B10-20E-G38-8-P3
		9	576448	VABM-B10-20E-G38-9-P3
		10	576449	VABM-B10-20E-G38-10-P3
			For 5/2 and 5/3-way valves, incl. seals and screws for valve assembly  -  - <b>Note</b> Blanking plugs for sealing the supply ports (1, 3, 5, 12 and 14) at one end are included in the scope of delivery.	2
3	576340			VABM-B10-20E-G38-3
4	576341			VABM-B10-20E-G38-4
5	576342			VABM-B10-20E-G38-5
6	576343			VABM-B10-20E-G38-6
7	576344			VABM-B10-20E-G38-7
8	576345			VABM-B10-20E-G38-8
9	576346			VABM-B10-20E-G38-9
10	576347			VABM-B10-20E-G38-10
<b>Manifold block, extension module for standard manifold block</b>				
	For 3/2-way valves, incl. seals and screws for mounting valves	2	576490	VABM-B10-20EEE-G38-2-P3
	For 5/2 and 5/3-way valves, incl. seals and screws for valve assembly	2	576489	VABM-B10-20EEE-G38-2
<b>Compact manifold block</b>				
	For 3/2-way valves, incl. seals and screws for mounting valves  -  - <b>Note</b> Blanking plugs for sealing the supply ports (1 and 3) at one end are included in the scope of delivery.	2	576465	VABM-B10-20S-G14-2-P3
		3	576466	VABM-B10-20S-G14-3-P3
		4	576467	VABM-B10-20S-G14-4-P3
		5	576468	VABM-B10-20S-G14-5-P3
		6	576469	VABM-B10-20S-G14-6-P3
		7	576470	VABM-B10-20S-G14-7-P3
		8	576471	VABM-B10-20S-G14-8-P3
		9	576472	VABM-B10-20S-G14-9-P3
		10	576473	VABM-B10-20S-G14-10-P3
			For 5/2 and 5/3-way valves, incl. seals and screws for valve assembly  -  - <b>Note</b> Blanking plugs for sealing the supply ports (1, 3 and 5) at one end are included in the scope of delivery.	2
3	576418			VABM-B10-20S-G14-3
4	576419			VABM-B10-20S-G14-4
5	576420			VABM-B10-20S-G14-5
6	576421			VABM-B10-20S-G14-6
7	576422			VABM-B10-20S-G14-7
8	576423			VABM-B10-20S-G14-8
9	576424			VABM-B10-20S-G14-9
10	576425			VABM-B10-20S-G14-10





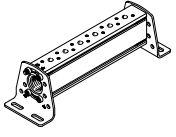
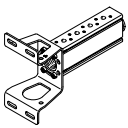

## Ordering data – Manifold block, size 20

Ordering data	Description	Valve positions	Part no.	Type
<b>Common supply manifold</b>				
	For mounting on both sides, incl. seals and screws for valve mounting	2	576363	VABM-B10-20-G38-2-P53
		3	576364	VABM-B10-20-G38-3-P53
		4	576365	VABM-B10-20-G38-4-P53
		5	576366	VABM-B10-20-G38-5-P53
		6	576367	VABM-B10-20-G38-6-P53
		7	576368	VABM-B10-20-G38-7-P53
		8	576369	VABM-B10-20-G38-8-P53
		9	576370	VABM-B10-20-G38-9-P53
		10	576371	VABM-B10-20-G38-10-P53
			For mounting on one side, incl. seals and screws for valve mounting	2
3	576415			VABM-B10-20-G38-3-P53-E
4	576416			VABM-B10-20-G38-4-P53-E



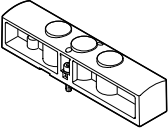
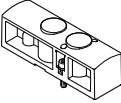

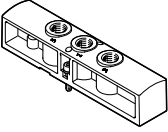
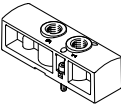
 **Note**

Blanking plug for sealing the supply port (1) at one end included in the scope of delivery.

Accessories – Manifold block, size 20





Ordering data	Description	Weight [g]	Part no.	Type
<b>Blanking plate</b>				
	For valve position on manifold block for 5/2-, 5/3-way valves	78	<b>576410</b>	<b>VABB-B10-20-E</b>
	For valve position on manifold block for 3/2-way valves	56	<b>576411</b>	<b>VABB-B10-20-E-P3</b>
	For valve position on common supply manifold	13	<b>576409</b>	<b>VABB-B10-20-A</b>
<b>Supply plate</b>				
	For valve position on manifold block for 5/2-, 5/3-way valves	78	<b>576492</b>	<b>VABF-B10-20-P1A4-G18</b>
	For valve position on manifold block for 3/2-way valves	56	<b>576493</b>	<b>VABF-B10-20-P1A4-G18-P3</b>
<b>Supply plate</b>				
	For valve position on common supply manifold	13	<b>576491</b>	<b>VABF-B10-20-P1-G18</b>

## Accessories – Manifold block, size 20

Ordering data		Description	Part no.	Type	PU <sup>1)</sup>
<b>Push-in fitting with external hex</b>					
	Connecting thread M5 for tubing O.D.	12 mm	<b>186350</b>	<b>QS-G1/4-12</b>	10
	Connecting thread G3/8 for tubing O.D.	16 mm	<b>186347</b>	<b>QS-G3/8-16</b>	1
<b>Push-in fitting with internal hex</b>					
	Connecting thread M5 for tubing O.D.	4 mm	<b>153315</b>	<b>QSM-M5-4-I</b>	10
	Connecting thread G1/8 for tubing O.D.	4 mm	<b>186106</b>	<b>QS-G1/8-4-I</b>	10
			<b>133008</b>	<b>QS-G1/8-4-I-100</b>	100
		6 mm	<b>186107</b>	<b>QS-G1/8-6-I</b>	10
			<b>133009</b>	<b>QS-G1/8-6-I-100</b>	100
			<b>186109</b>	<b>QS-G1/8-8-I</b>	10
	8 mm	<b>133010</b>	<b>QS-G1/8-8-I-100</b>	100	
		Connecting thread G1/4 for tubing O.D.	8 mm	<b>186110</b>	<b>QS-G1/4-8-I</b>
	Connecting thread G3/8 for tubing O.D.	10 mm	<b>186112</b>	<b>QS-G1/4-10-I</b>	10
		8 mm	<b>186111</b>	<b>QS-G3/8-8-I</b>	10
		10 mm	<b>186113</b>	<b>QS-G3/8-10-I</b>	10
12 mm	<b>186114</b>	<b>QS-G3/8-12-I</b>	10		
<b>Angled push-in fitting with external hex</b>					
	Connecting thread G1/8 for tubing O.D.	4 mm	<b>186116</b>	<b>QSL-G1/8-4</b>	10
			<b>132048</b>	<b>QSL-G1/8-4-100</b>	100
		6 mm	<b>186117</b>	<b>QSL-G1/8-6</b>	10
			<b>132049</b>	<b>QSL-G1/8-6-100</b>	100
			<b>186119</b>	<b>QSL-G1/8-8</b>	10
	8 mm	<b>132050</b>	<b>QSL-G1/8-8-50</b>	50	
		Connecting thread G1/4 for tubing O.D.	8 mm	<b>186120</b>	<b>QSL-G1/4-8</b>
	10 mm	<b>132052</b>	<b>QSL-G1/4-8-50</b>	50	
		<b>186122</b>	<b>QSL-G1/4-10</b>	10	
		<b>132053</b>	<b>QSL-G1/4-10-50</b>	50	
		12 mm	<b>186351</b>	<b>QSL-G1/4-12</b>	10
		<b>132054</b>	<b>QSL-G1/4-12-20</b>	20	
	Connecting thread G3/8 for tubing O.D.	8 mm	<b>186121</b>	<b>QSL-G3/8-8</b>	10
			<b>132055</b>	<b>QSL-G3/8-8-50</b>	50
		10 mm	<b>186123</b>	<b>QSL-G3/8-10</b>	10
			<b>132056</b>	<b>QSL-G3/8-10-20</b>	20
12 mm		<b>186124</b>	<b>QSL-G3/8-12</b>	10	
		<b>132057</b>	<b>QSL-G3/8-12-20</b>	20	
16 mm	<b>186348</b>	<b>QSL-G3/8-16</b>	1		
<b>Angled push-in fitting with external hex</b>					
	Connecting thread G1/8 for tubing O.D.	4 mm	<b>186116</b>	<b>QSL-G1/8-4</b>	10
			<b>132048</b>	<b>QSL-G1/8-4-100</b>	100
		6 mm	<b>186117</b>	<b>QSL-G1/8-6</b>	10
			<b>132049</b>	<b>QSL-G1/8-6-100</b>	100
		8 mm	<b>186119</b>	<b>QSL-G1/8-8</b>	10
	<b>132050</b>	<b>QSL-G1/8-8-50</b>	50		

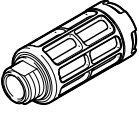
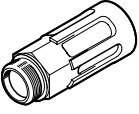
1) Packaging unit

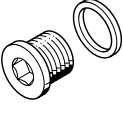
Accessories – Manifold block, size 20

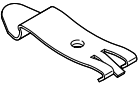
Ordering data		Description	Part no.	Type	PU <sup>1)</sup>
<b>Silencer</b>					
	With connecting thread G, polymer design	G1/8	2307	U-1/8	1
			534222	U-1/8-50	50
		G1/4	2316	U-1/4	1
			534223	U-1/4-20	20
	With connecting thread G, metal design	G3/8	534224	U-3/8-20	20
		G1/8	6841	U-1/8-B	1
		G1/4	6842	U-1/4-B	1
	With connecting thread G, sintered design, long	G3/8	6843	U-3/8-B	1
		G1/4	1205861	AMTE-M-LH-G14	20
G3/8	1205862	AMTE-M-LH-G38	10		
<b>Blanking plug</b>					
	With connecting thread G	G1/8	3568	B-1/8	10
			534213	B-1/8-100	100
		G1/4	3569	B-1/4	10
			534214	B-1/4-50	50
		G3/8	3570	B-3/8	10
			534215	B-3/8-20	20
<b>Separator</b>					
	For creating pressure zones	G1/4	569996	VABD-10-B	1
		G3/8	574483	VABD-14-B	1
<b>H-rail mounting</b>					
	For size 20, for mounting on standard H-rails TH 35-7.5 or TH 35-15 to EN 60715		569998	VAME-T-M4	2

1) Packaging unit

## Data sheet – Manifold block, size 25

-  - Flow rate  
up to 1300 l/min

-  - Valve width  
26.5 mm

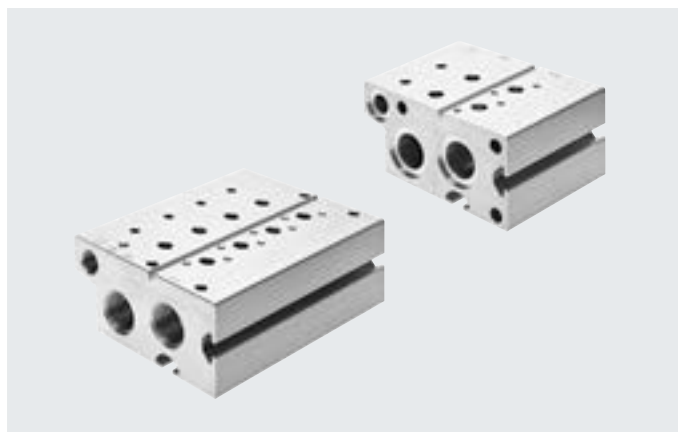

General technical data	Manifold block standard		Extension module for standard manifold block		Manifold block compact		Common supply manifold	
	3/2	5/2, 5/3	3/2	5/2, 5/3	3/2	5/2, 5/3	On both sides	On one side
For valves	3/2	5/2, 5/3	3/2	5/2, 5/3	3/2	5/2, 5/3	3/2, 5/2, 5/3	
Grid dimension [mm]	27.5							
Type of mounting	Via through-hole						Via mounting bracket	
Maximum number of valve positions	10	10	2	2	10	10	10	4
Port 1	G1/2	G1/2	G1/2	G1/2	G3/8	G3/8	G1/2	G1/2
Port 3	G1/2	G1/2	G1/2	G1/2	G3/8	G3/8	-	-
Port 5	-	G1/2	-	G1/2	-	G3/8	-	-
Port 12	G1/8	G1/8	G1/8	G1/8	-	-	-	-
Port 14	-	G1/8	-	G1/8	-	-	-	-
CRC <sup>1)</sup>	2 <sup>1)</sup>							

1) More information: [www.festo.com/x/topic/kbk](http://www.festo.com/x/topic/kbk)

Weight [g]	2	3	4	5	6	7	8	9	10
<b>Manifold block for 3/2-way valves, standard</b>									
VABM-B10-25E...G12-...P3	726	960	1194	1428	1662	1896	2130	2364	2598
<b>Manifold block, extension module for 3/2-way valves, standard</b>									
VABM-B10-25EEE-G12-2-P3	340	-	-	-	-	-	-	-	-
<b>Manifold block for 5/2- and 5/3-way valves, standard</b>									
VABM-B10-25E...G12-...	927	1224	1521	1818	2115	2412	2709	3006	3303
<b>Manifold block, extension module for 5/2- and 5/3-way valves, standard</b>									
VABM-B10-25EEE-G12-2	258	-	-	-	-	-	-	-	-
<b>Manifold block for 3/2-way valves, compact</b>									
VABM-B10-25S...G38-...P3	369	488	607	726	845	964	1083	1202	1321
<b>Manifold block for 5/2- and 5/3-way valves, compact</b>									
VABM-B10-25S...G38-...	438	579	720	861	1002	1143	1284	1425	1566
<b>Common supply manifold for mounting on both sides</b>									
VABM-B10-25...G12-...P53	258	340	422	504	586	668	750	832	914
<b>Common supply manifold for mounting on one side</b>									
VABM-B10-25-G12-...-P53-E	258	340	422	-	-	-	-	-	-

Information on materials	
Information on materials	Wrought aluminium alloy
Note on materials	RoHS-compliant

Data sheet – Manifold block, size 25

**Dimensions**

Manifold block for 3/2-way valves, standard

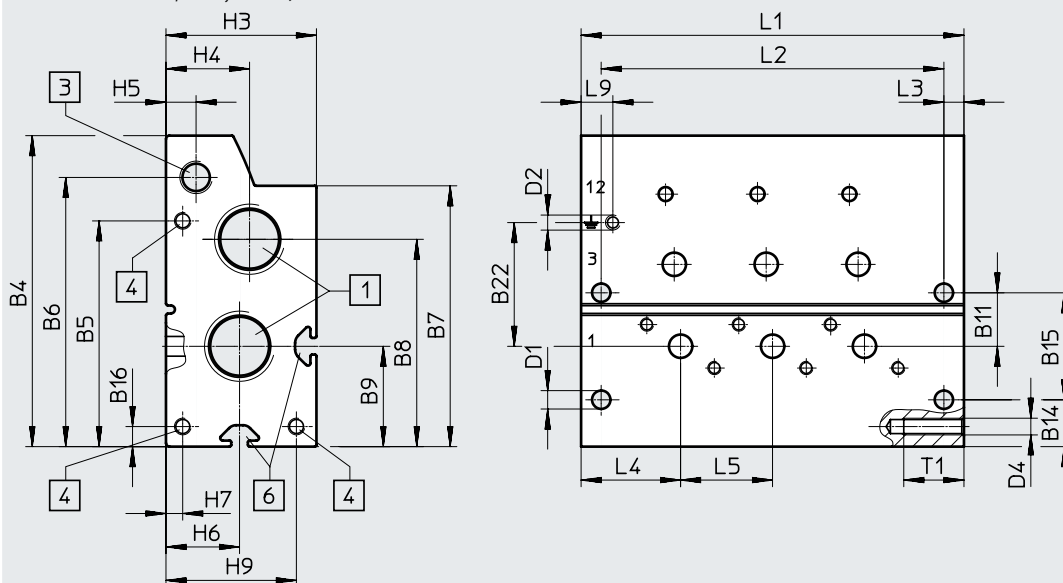

- [1] Ports 1 and 3 (at both ends): G1/2
- [2] Ports 2 and 4 (at both ends): G1/2
- [3] Port 12 (at both ends): G1/8
- [4] Thread M5x18 for extension module
- [5] Thread M5x18 for extension module
- [6] Profile slot IPM-05, system 5

Type	B4	B5	B6	B7	B8	B9	B11	B14	B15	B16	B22
VABM-B10-25-E...G12-...-P3	93	67.5	80.5	78	62	30	16	14	32	6	37

Type	D1 ø	D2	D4	H3	H4	H5	H6	H7	H9	L3	L4	L5	L9	T1
VABM-B10-25-E...G12-...-P3	5.5	M4x9	M5	45	25	9	22	5	39	6	29.8	27.5	9.5	18

  

Valve positions	2	3	4	5	6	7	8	9	10
L1 [mm]	87	114.5	142	169.5	197	224.5	252	279.5	307
L2 [mm]	75	102.5	130	157.5	185	212.5	240	267.5	295

## Data sheet – Manifold block, size 25

### Dimensions

Manifold block, extension module for 3/2-way valves, standard

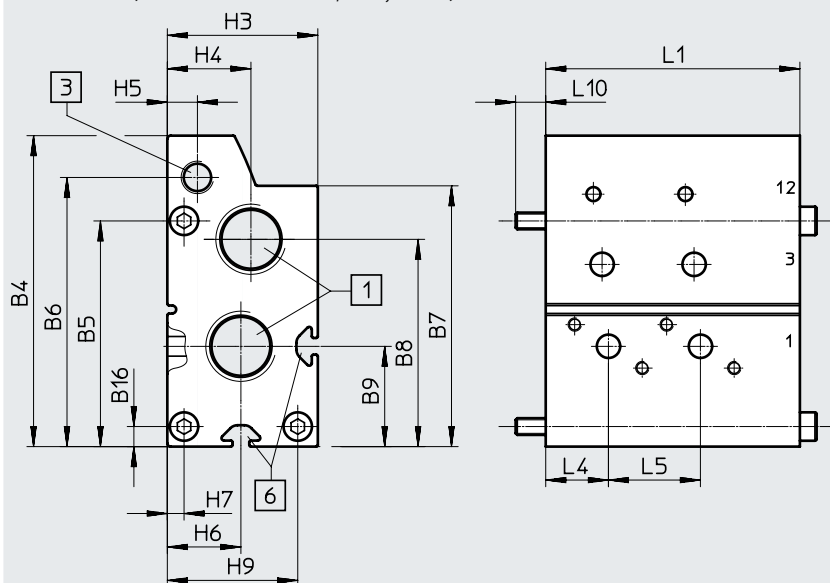

[1] Ports 1 and 3; threaded connection G1/2 at one end

[3] Threaded connection at port 12: G1/8 at one end

[6] Profile slot IPM-05, system 5

Type	B4	B5	B6	B7	B8	B9	B16	H3	H4	H5	H6	H7	H9	L4	L5	L10
VABM-B10-25EEE-G12-2-P3	93	67.5	80.5	78	62	30	6	45	25	9	22	5	39	18.8	27.5	9
Valve positions	2															
L1 [mm]	76															

## Data sheet – Manifold block, size 25

### Dimensions

Manifold block for 5/2- and 5/3-way valves, standard

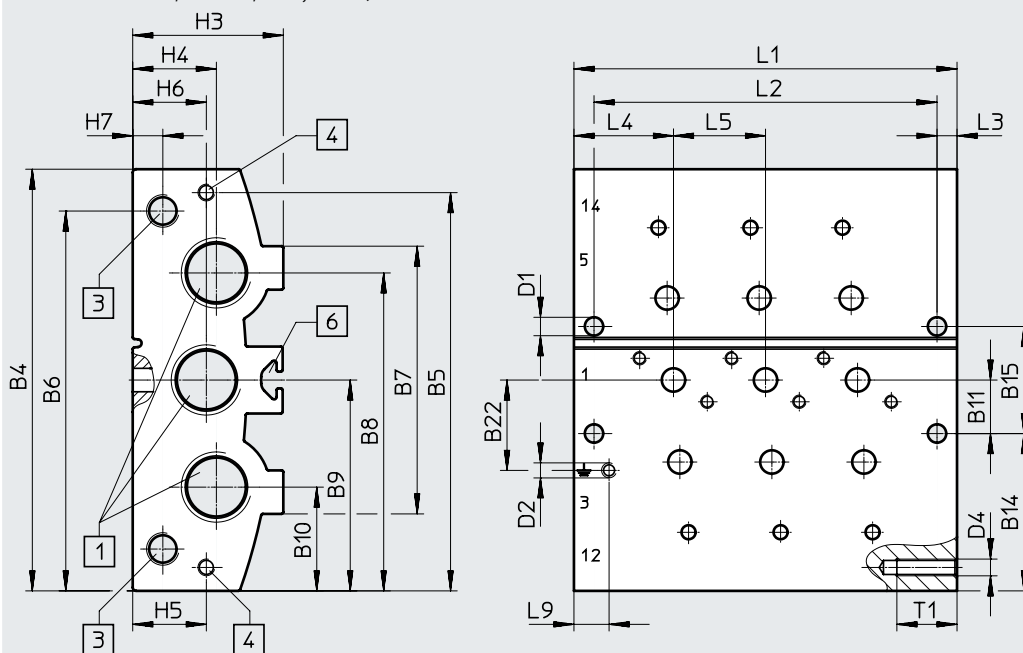

[1] Ports 1, 3 and 5 (at both ends):  
G1/2

[3] Ports 12 and 14 (at both ends):  
G1/8

[4] Thread M5x18 for extension  
module

[6] Profile slot IPM-05, system 5

Type	B4	B5	B6	B7	B8	B9	B10	B11	B14	B15	B22
VABM-B10-25E....G12...	126	119	113.5	80	95	63	31	16	47	32	27

Type	D1 ø	D2	D4	H3	H4	H5	H6	H7	L3	L4	L5	L9	T1
VABM-B10-25E....G12...	5.5	M4x9	M5	45	25	22	22	9	6	29.8	27.5	10.5	18

Valve positions	2	3	4	5	6	7	8	9	10
L1 [mm]	87	114.5	142	169.5	197	224.5	252	279.5	307
L2 [mm]	75	102.5	130	157.5	185	212.5	240	267.5	295



## Data sheet – Manifold block, size 25

### Dimensions

Manifold block, extension module for 5/2- and 5/3-way valves, standard

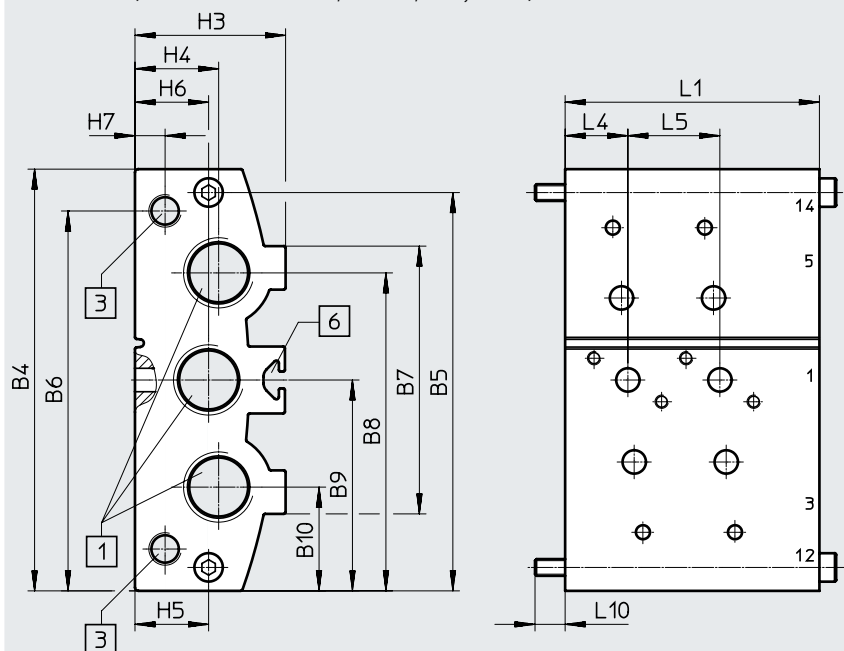

[1] Ports 1, 3 and 5; threaded connection G1/2 at one end

[3] Threaded connection at ports 12 and 14: G1/8 at one end

[6] Profile slot IPM-05, system 5

Type	B4	B5	B6	B7	B8	B9	B10	H3	H4	H5	H6	H7	L4	L5	L10
VABM-B10-20EEE-G12-2	126	119	113.5	80	95	63	31	45	25	22	22	9	18.8	27.5	9
Valve positions	2														
L1 [mm]	76														

Data sheet – Manifold block, size 25

**Dimensions**

Manifold block for 3/2-way valves, compact

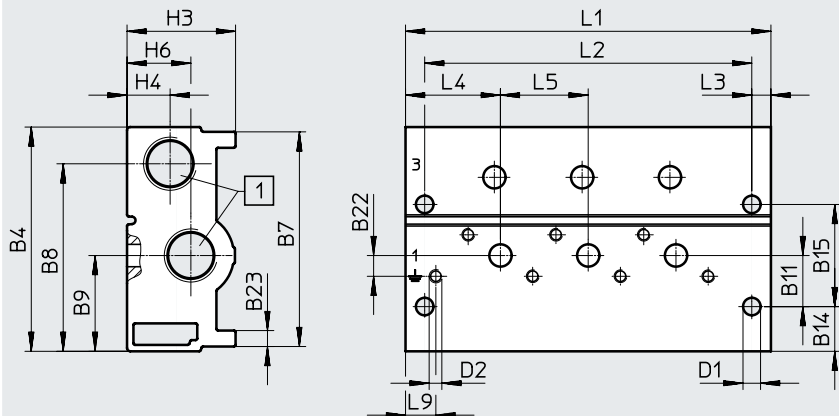

[1] Ports 1 and 3 (at both ends):  
G3/8

Type	B4	B7	B8	B9	B11	B14	B15	B22	B23
VABM-B10-25S-...G38-...-P3	70.3	67.3	58.8	30	16	14	32	6.5	5

Type	D1 ø	D2	H3	H4	H6	L3	L4	L5	L9
VABM-B10-25S-...G38-...-P3	5.5	M4x9	34	13.5	20	6	29.8	27.5	9.5

Valve positions	2	3	4	5	6	7	8	9	10
L1 [mm]	87	114.5	142	169.5	197	224.5	252	279.5	307
L2 [mm]	75	102.5	130	157.5	185	212.5	240	267.5	295

## Data sheet – Manifold block, size 25

### Dimensions

Manifold block for 5/2- and 5/3-way valves, compact

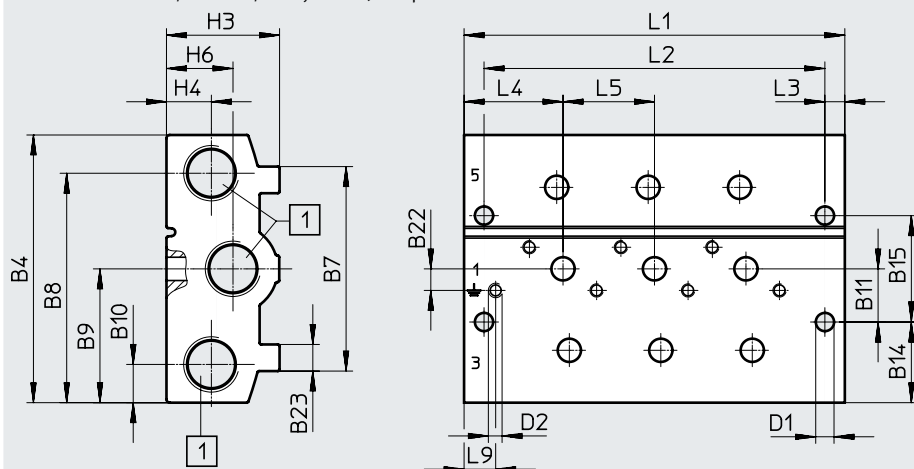

[1] Ports 1, 3 and 5 (at both ends):  
G3/8

Type	B4	B7	B8	B9	B10	B11	B14	B15	B22	B23
VABM-B10-25S-...G38-...	80.5	61.5	69	40.3	11.5	16	24.3	32	6.5	8

Type	D1 ø	D2	H3	H4	H6	L3	L4	L5	L9
VABM-B10-25S-...G38-...	5.5	M4x9	34	13.5	20	6	29.8	27.5	9.5

Valve positions	2	3	4	5	6	7	8	9	10
L1 [mm]	87	114.5	142	169.5	197	224.5	252	279.5	307
L2 [mm]	75	102.5	130	157.5	185	212.5	240	267.5	295

Data sheet – Manifold block, size 25

**Dimensions**

Common supply manifold, mounting on both sides

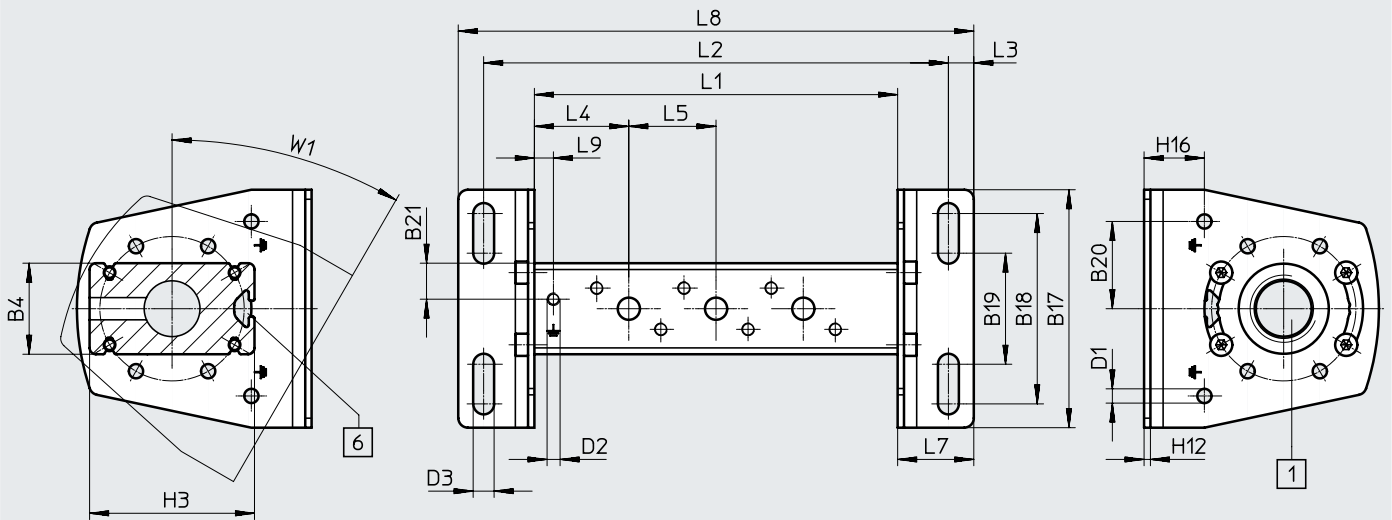

[1] Port 1 (at both ends): G1/2

[6] Profile slot IPM-05, system 5

-  - **Note**

Mounting bracket can be adjusted through  $\pm 30^\circ$

Type	B4	B17	B18	B19	B20	B21	D1 $\varnothing$	D2	D3 $\varnothing$	H3	H12	H16	L3	L4	L5	L7	L9	W1
VABM-B10-25-G12...-P53	28.7	75	60	35	27.5	11.4	4.5	M4x9	6.6	52	2	19	8	29.8	27.5	24	6	30

Valve positions	2	3	4	5	6	7	8	9	10
L1 [mm]	87	114.5	142	169.5	197	224.5	252	279.5	307
L2 [mm]	119	146.5	174	201.5	229	256.5	284	311.5	339
L8 [mm]	135	162.5	190	217.5	245	272.5	300	327.5	355

**Dimensions**

Common supply manifold, mounting on one side

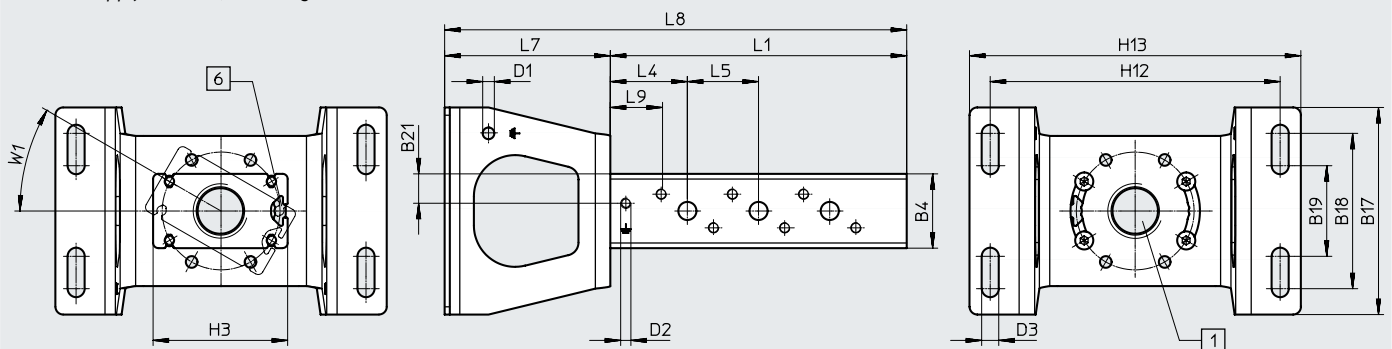

[1] Port 1 (at both ends): G1/2

[6] Profile slot IPM-05, system 5







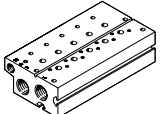

-  - **Note**

Mounting bracket can be adjusted through  $\pm 30^\circ$

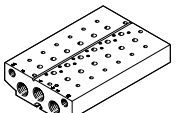
Type	B4	B17	B18	B19	B21	D1 $\varnothing$	D2	D3 $\varnothing$	H3	H13	H14	L4	L5	L7	L9	W1
VABM-B10-25-G12...-P53-E	28.7	80	60	35	11.4	4.5	M4x9	6.6	52	128	112	29.8	27.5	64	6	30°

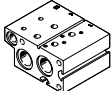
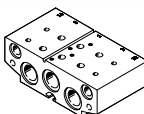
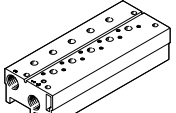
Valve positions	2	3	4
L1 [mm]	87	114.5	142
L8 [mm]	151	178.5	206

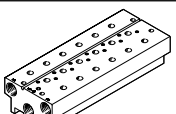
## Ordering data – Manifold block, size 25

Ordering data	Description	Valve positions	Part no.	Type
<b>Standard manifold block</b>				
	For 3/2-way valves, incl. seals and screws for mounting valves  -  - <b>Note</b> Blanking plugs for sealing the supply ports (1, 3 and 14) at one end are included in the scope of delivery.	2	8026279	VABM-B10-25E-G12-2-P3
		3	8026280	VABM-B10-25E-G12-3-P3
		4	8026281	VABM-B10-25E-G12-4-P3
		5	8026282	VABM-B10-25E-G12-5-P3
		6	8026283	VABM-B10-25E-G12-6-P3
		7	8026284	VABM-B10-25E-G12-7-P3
		8	8026285	VABM-B10-25E-G12-8-P3
		9	8026286	VABM-B10-25E-G12-9-P3
		10	8026287	VABM-B10-25E-G12-10-P3
			For 5/2 and 5/3-way valves, incl. seals and screws for valve assembly  -  - <b>Note</b> Blanking plugs for sealing the supply ports (1, 3, 5, 12 and 14) at one end are included in the scope of delivery.	2
3	8026244			VABM-B10-25E-G12-3
4	8026245			VABM-B10-25E-G12-4
5	8026246			VABM-B10-25E-G12-5
6	8026247			VABM-B10-25E-G12-6
7	8026248			VABM-B10-25E-G12-7
8	8026249			VABM-B10-25E-G12-8
9	8026250			VABM-B10-25E-G12-9
10	8026251			VABM-B10-25E-G12-10
<b>Manifold block, extension module for standard manifold block</b>				
	For 3/2-way valves, incl. seals and screws for mounting valves	2	8026316	VABM-B10-25EEE-G12-2-P3
	For 5/2 and 5/3-way valves, incl. seals and screws for valve assembly	2	8026315	VABM-B10-25EEE-G12-2
<b>Compact manifold block</b>				
	For 3/2-way valves, incl. seals and screws for mounting valves  -  - <b>Note</b> Blanking plugs for sealing the supply ports (1 and 3) at one end are included in the scope of delivery.	2	8026297	VABM-B10-25S-G38-2-P3
		3	8026298	VABM-B10-25S-G38-3-P3
		4	8026299	VABM-B10-25S-G38-4-P3
		5	8026300	VABM-B10-25S-G38-5-P3
		6	8026301	VABM-B10-25S-G38-6-P3
		7	8026302	VABM-B10-25S-G38-7-P3
		8	8026303	VABM-B10-25S-G38-8-P3
		9	8026304	VABM-B10-25S-G38-9-P3
		10	8026305	VABM-B10-25S-G38-10-P3
			For 5/2 and 5/3-way valves, incl. seals and screws for valve assembly  -  - <b>Note</b> Blanking plugs for sealing the supply ports (1, 3 and 5) at one end are included in the scope of delivery.	2
3	8026262			VABM-B10-25S-G38-3
4	8026263			VABM-B10-25S-G38-4
5	8026264			VABM-B10-25S-G38-5
6	8026265			VABM-B10-25S-G38-6
7	8026266			VABM-B10-25S-G38-7
8	8026267			VABM-B10-25S-G38-8
9	8026268			VABM-B10-25S-G38-9
10	8026269			VABM-B10-25S-G38-10

Ordering data – Manifold block, size 25

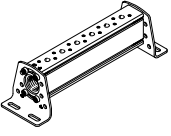
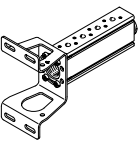



Ordering data	Description	Valve positions	Part no.	Type
<b>Common supply manifold</b>				
	For mounting on both sides, incl. seals and screws for valve assembly	2	8026219	VABM-B10-25-G12-2-P53
		3	8026220	VABM-B10-25-G12-3-P53
		4	8026221	VABM-B10-25-G12-4-P53
		5	8026222	VABM-B10-25-G12-5-P53
		6	8026223	VABM-B10-25-G12-6-P53
		7	8026224	VABM-B10-25-G12-7-P53
		8	8026225	VABM-B10-25-G12-8-P53
		9	8026226	VABM-B10-25-G12-9-P53
		10	8026227	VABM-B10-25-G12-10-P53
			For mounting on one side, incl. seals and screws for valve mounting	2
3	8026238			VABM-B10-25-G12-3-P53-E
4	8026239			VABM-B10-25-G12-4-P53-E



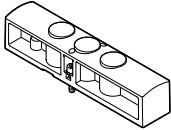
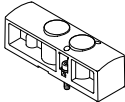

**Note**

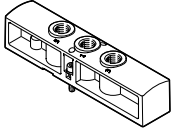
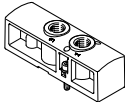
Blanking plug for sealing the supply port (1) at one end included in the scope of delivery.

## Accessories – Manifold block, size 25

Ordering data	Description	Weight [g]	Part no.	Type
<b>Blanking plate</b>				
	For valve position on manifold block for 5/2-, 5/3-way valves	117	<b>8026209</b>	<b>VABB-B10-25-E</b>
	For valve position on manifold block for 3/2-way valves	84	<b>8026210</b>	<b>VABB-B10-25-E-P3</b>
	For valve position on common supply manifold	28	<b>8026208</b>	<b>VABB-B10-25-A</b>
<b>Supply plate</b>				
	For valve position on manifold block for 5/2-, 5/3-way valves	110	<b>8026318</b>	<b>VABF-B10-25-P1A4-G14</b>
	For valve position on manifold block for 3/2-way valves	80	<b>8026319</b>	<b>VABF-B10-25-P1A4-G14-P3</b>
	For valve position on common supply manifold	26	<b>8026317</b>	<b>VABF-B10-25-P1-G14</b>



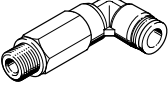

Accessories – Manifold block, size 25

Ordering data		Description	Part no.	Type	PU <sup>1)</sup>
<b>Push-in fitting with external hex</b>					
	Connecting thread G3/8 for tubing O.D.	16 mm	<b>186347</b>	<b>QS-G3/8-16</b>	1
	Connecting thread G1/2 for tubing O.D.	16 mm	<b>186105</b>	<b>QS-G1/2-16</b>	1
			<b>132047</b>	<b>QS-G1/2-16-20</b>	20
<b>Push-in fitting with internal hex</b>					
	Connecting thread M5 for tubing O.D.	4 mm	<b>153315</b>	<b>QSM-M5-4-I</b>	10
	Connecting thread G1/8 for tubing O.D.	6 mm	<b>186107</b>	<b>QS-G1/8-6-I</b>	10
			<b>133009</b>	<b>QS-G1/8-6-I-100</b>	100
			<b>186108</b>	<b>QS-G1/4-6-I</b>	10
	Connecting thread G1/4 for tubing O.D.	6 mm	<b>186110</b>	<b>QS-G1/4-8-I</b>	10
			<b>186112</b>	<b>QS-G1/4-10-I</b>	10
			<b>186111</b>	<b>QS-G3/8-8-I</b>	10
	Connecting thread G3/8 for tubing O.D.	8 mm	<b>186113</b>	<b>QS-G3/8-10-I</b>	10
			<b>186114</b>	<b>QS-G3/8-12-I</b>	10
<b>186115</b>			<b>QS-G1/2-12-I</b>	1	
Connecting thread G1/2 for tubing O.D.	12 mm				
<b>Angled push-in fitting with external hex</b>					
	Connecting thread G1/4 for tubing O.D.	6 mm	<b>186118</b>	<b>QSL-G1/4-6</b>	10
			<b>132051</b>	<b>QSL-G1/4-6-100</b>	100
		8 mm	<b>186120</b>	<b>QSL-G1/4-8</b>	10
			<b>132052</b>	<b>QSL-G1/4-8-50</b>	50
		10 mm	<b>186122</b>	<b>QSL-G1/4-10</b>	10
			<b>132053</b>	<b>QSL-G1/4-10-50</b>	50
	Connecting thread G3/8 for tubing O.D.	8 mm	<b>186121</b>	<b>QSL-G3/8-8</b>	10
			<b>132055</b>	<b>QSL-G3/8-8-50</b>	50
		10 mm	<b>186123</b>	<b>QSL-G3/8-10</b>	10
			<b>132056</b>	<b>QSL-G3/8-10-20</b>	20
		12 mm	<b>186124</b>	<b>QSL-G3/8-12</b>	10
			<b>132057</b>	<b>QSL-G3/8-12-20</b>	20
	Connecting thread G1/2 for tubing O.D.	12 mm	<b>186125</b>	<b>QSL-G1/2-12</b>	1
			<b>132058</b>	<b>QSL-G1/2-12-20</b>	20
		16 mm	<b>186126</b>	<b>QSL-G1/2-16</b>	1
<b>132059</b>	<b>QSL-G1/2-16-20</b>	20			
<b>Angled push-in fitting, long, with external hex</b>					
	Connecting thread G1/4 for tubing O.D.	6 mm	<b>186129</b>	<b>QSL-G1/4-6</b>	10
		8 mm	<b>186131</b>	<b>QSL-G1/4-8</b>	10
		10 mm	<b>186133</b>	<b>QSL-G1/4-10</b>	10

1) Packaging unit

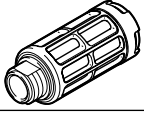
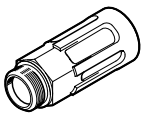

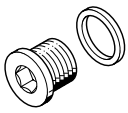

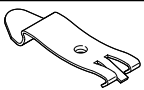
## Accessories – Manifold block, size 25

Ordering data		Description	Part no.	Type	PU <sup>1)</sup>
<b>Silencer</b>					
	With connecting thread G, polymer design	G1/4	2316	U-1/4	1
			534223	U-1/4-20	20
		G3/8	534224	U-3/8-20	20
	With connecting thread G, metal design	G1/4	6842	U-1/4-B	1
		G3/8	6843	U-3/8-B	1
		G1/2	6844	U-1/2-B	1
	With connecting thread G, sintered design, long	G3/8	1205862	AMTE-M-LH-G38	10
		G1/2	1205863	AMTE-M-LH-G12	10
<b>Blanking plug</b>					
	With connecting thread G	G1/8	3568	B-1/8	10
			534213	B-1/8-100	100
		G3/8	3570	B-3/8	10
			534215	B-3/8-20	20
		G1/2	3571	B-1/2	10
			534216	B-1/2-20	20
<b>Separator</b>					
	For creating pressure zones	G1/8	569995	VABD-8-B	1
		G3/8	574483	VABD-14-B	1
		G1/2	8022483	VABD-17.5-B	1
<b>H-rail mounting</b>					
	For size 25, for mounting on standard H-rails TH 35-7.5 or TH 35-15 to EN 60715		2636436	VAME-T-M5	2

1) Packaging unit

Data sheet – Manifold block, size 30

-  - Flow rate  
up to 2300 l/min

-  - Valve width  
31 mm

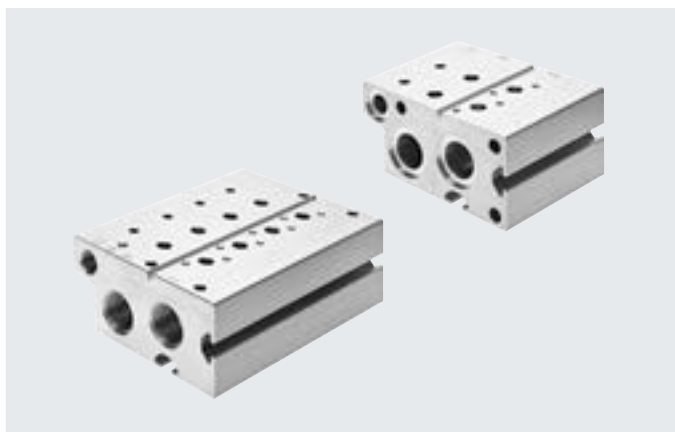

**General technical data**

	Manifold block standard		Extension module for standard manifold block		Manifold block compact		Common supply manifold	
	3/2	5/2, 5/3	3/2	5/2, 5/3	3/2	5/2, 5/3	On both sides	On one side
For valves	3/2	5/2, 5/3	3/2	5/2, 5/3	3/2	5/2, 5/3	3/2, 5/2, 5/3	
Grid dimension [mm]	32							
Type of mounting	Via through-hole						Via mounting bracket	
Maximum number of valve positions	10	10	2	2	10	10	10	4
Port 1	G3/4	G3/4	G3/4	G3/4	G1/2	G1/2	G3/4	G3/4
Port 3	G3/4	G3/4	G3/4	G3/4	G1/2	G1/2	-	-
Port 5	-	G3/4	-	G3/4	-	G1/2	-	-
Port 12	G1/8	G1/8	G1/8	G1/8	-	-	-	-
Port 14	-	G1/8	-	G1/8	-	-	-	-
CRC <sup>1)</sup>	2 <sup>1)</sup>							

1) More information: [www.festo.com/x/topic/kbk](http://www.festo.com/x/topic/kbk)

**Weight [g]**

Valve positions	2	3	4	5	6	7	8	9	10
<b>Manifold block for 3/2-way valves, standard</b>									
VABM-B10-30E-G34-...-P3	1411	1828	2245	2662	3079	3496	3913	4330	4747
<b>Manifold block, extension module for 3/2-way valves, standard</b>									
VABM-B10-30EEE-G34-2-P3	1111	-	-	-	-	-	-	-	-
<b>Manifold block for 5/2- and 5/3-way valves, standard</b>									
VABM-B10-30E-G34-...	1722	2213	2703	3194	3684	4175	4665	5156	5646
<b>Manifold block, extension module for 5/2- and 5/3-way valves, standard</b>									
VABM-B10-30EEE-G34-2	1318	-	-	-	-	-	-	-	-
<b>Manifold block for 3/2-way valves, compact</b>									
VABM-B10-30S-G12-...-P3	652	872	1093	1313	1533	1753	1973	2193	2413
<b>Manifold block for 5/2- and 5/3-way valves, compact</b>									
VABM-B10-30S-G12-...	759	1013	1267	1522	1776	2030	2285	2539	2793
<b>Common supply manifold for mounting on both sides</b>									
VABM-B10-30-G34-...-P53	818	977	1135	1293	1452	1610	1768	1927	2085
<b>Common supply manifold for mounting on one side</b>									
VABM-B10-30-G34-...-P53-E	852	1011	1169	-	-	-	-	-	-

**Information on materials**

Information on materials	Wrought aluminium alloy
Note on materials	RoHS-compliant

## Data sheet – Manifold block, size 30

### Dimensions

Manifold block for 3/2-way valves, standard

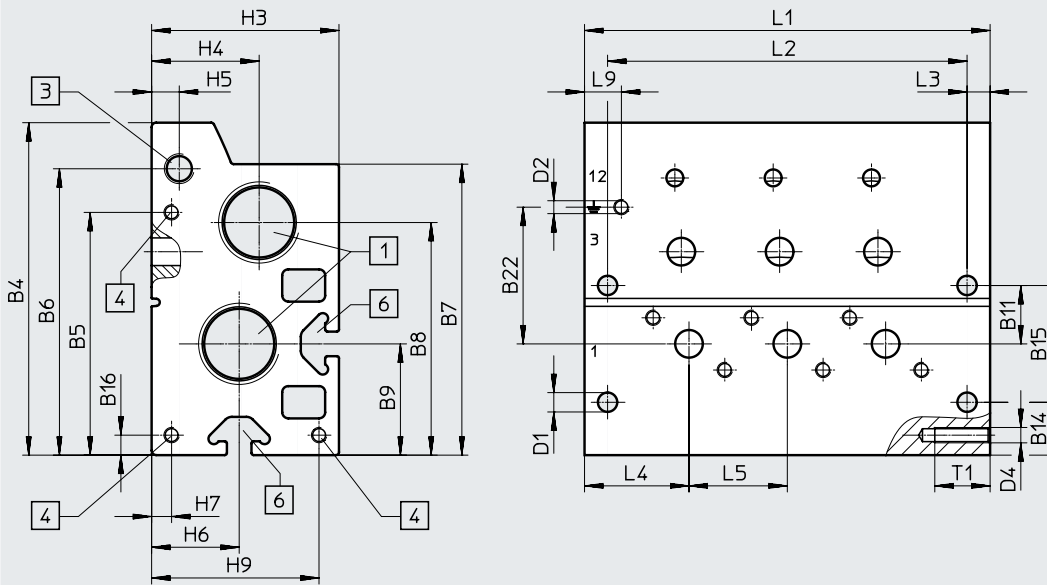

[1] Ports 1 and 3 (at both ends):  
G3/4

[3] Port 12 (at both ends): G1/8

[4] Thread M5x18 for extension  
module

[6] Profile slot IPM-08, system 8

Type	B4	B5	B6	B7	B8	B9	B11	B14	B15	B16	B22
VABM-B10-30-E-G34-...-P3	108.2	79	93.2	94.7	75.7	36.2	19	17.2	38	6.5	44.5

Type	D1 ø	D2	D4	H3	H4	H5	H6	H7	H9	L3	L4	L5	L9	T1
VABM-B10-30-E-G34-...-P3	6.3	M5x11	M5	61	35	9	28.5	6.5	54.5	7.5	34	32	12	18

Valve positions	2	3	4	5	6	7	8	9	10
L1 [mm]	100	132	164	196	228	260	292	324	356
L2 [mm]	85	117	149	181	213	245	277	309	341

Data sheet – Manifold block, size 30

**Dimensions**

Manifold block, extension module for 3/2-way valves, standard

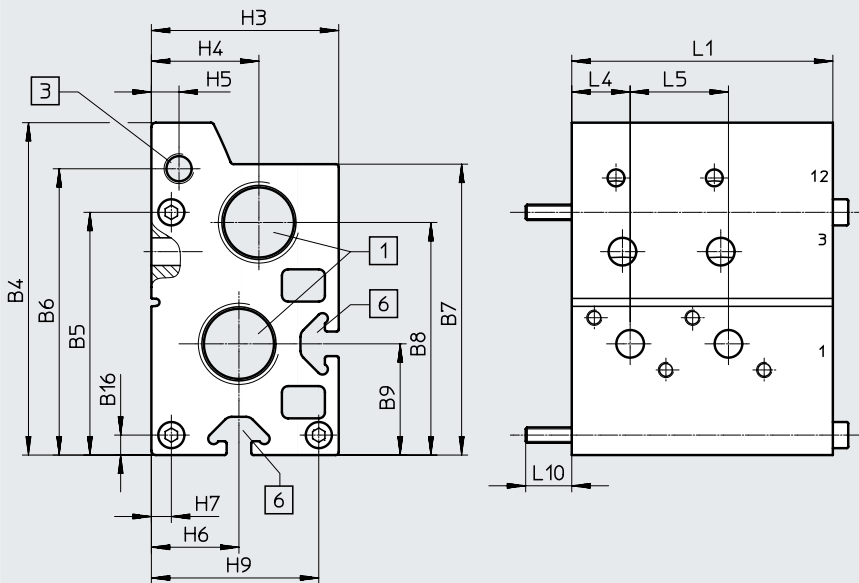

[1] Ports 1 and 3; threaded connection G3/4 at one end

[3] Threaded connection at port 12: G1/8 at one end

[6] Profile slot IPM-08, system 8

Type	B4	B5	B6	B7	B8	B9	B16	H3	H4	H5	H6	H7	H9	L4	L5	L10
VABM-B10-30EEE-G34-2-P3	108.2	79	93.2	94.7	75.7	36.2	6.5	61	35	9	28.5	6.5	54.5	19	32	15
Valve positions	2															
L1 [mm]	85															

## Data sheet – Manifold block, size 30

### Dimensions

Manifold block for 5/2- and 5/3-way valves, standard

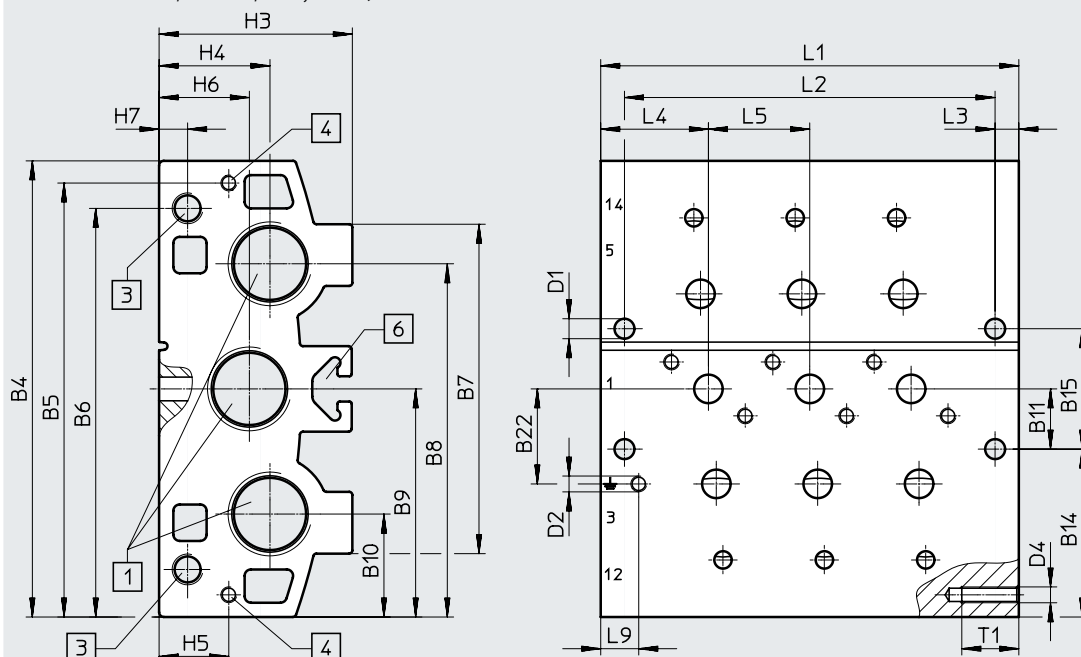

[1] Ports 1, 3 and 5 (at both ends):  
G3/4

[3] Ports 12 and 14 (at both ends):  
G1/8

[4] Thread M5x18 for extension  
module

[6] Profile slot IPM-08, system 8

Type	B4	B5	B6	B7	B8	B9	B10	B11	B14	B15	B22
VABM-B10-30E-G34-...	144	137	129	104	111.5	72	32.5	19	53	38	30

Type	D1 ø	D2	D4	H3	H4	H5	H6	H7	L3	L4	L5	L9	T1
VABM-B10-30E-G34-...	6.3	M5*11	M5	61	35	22	28.5	9	7.5	34	32	12	18

Valve positions	2	3	4	5	6	7	8	9	10
L1 [mm]	100	132	164	196	228	260	292	324	356
L2 [mm]	85	117	149	181	213	245	277	309	341

## Data sheet – Manifold block, size 30

### Dimensions

Manifold block, extension module for 5/2- and 5/3-way valves, standard

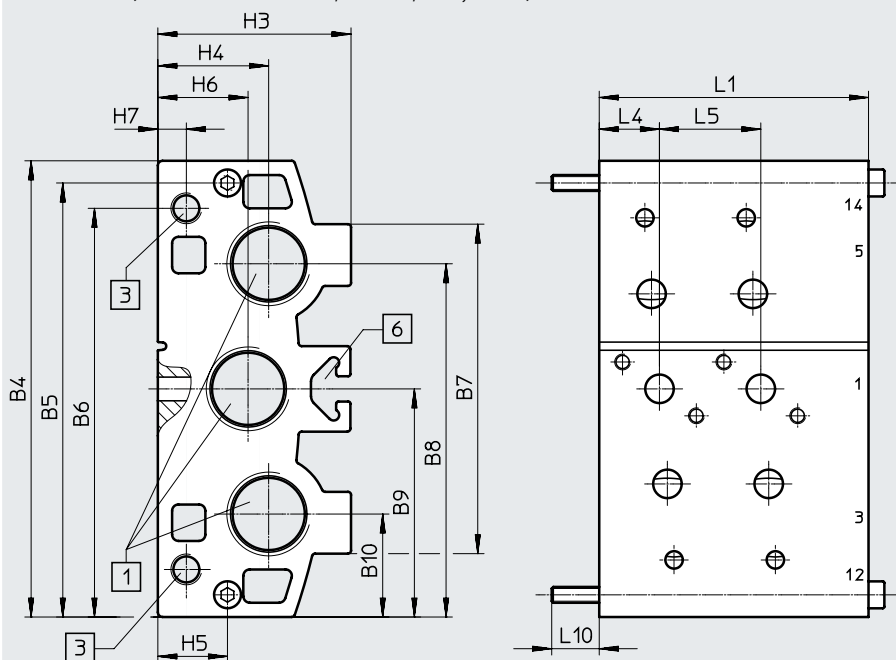

[1] Ports 1, 3 and 5; threaded connection G3/4 at one end

[3] Threaded connection at ports 12 and 14: G1/8 at one end

[6] Profile slot IPM-08, system 8

Type	B4	B5	B6	B7	B8	B9	B10	H3	H4	H5	H6	H7	L4	L5	L10
VABM-B10-30EEE-G34-2	144	137	129	104	111.5	72	32.5	61	35	22	28.5	9	19	32	15
Valve positions	2														
L1 [mm]	85														

## Data sheet – Manifold block, size 30

### Dimensions

Manifold block for 3/2-way valves, compact

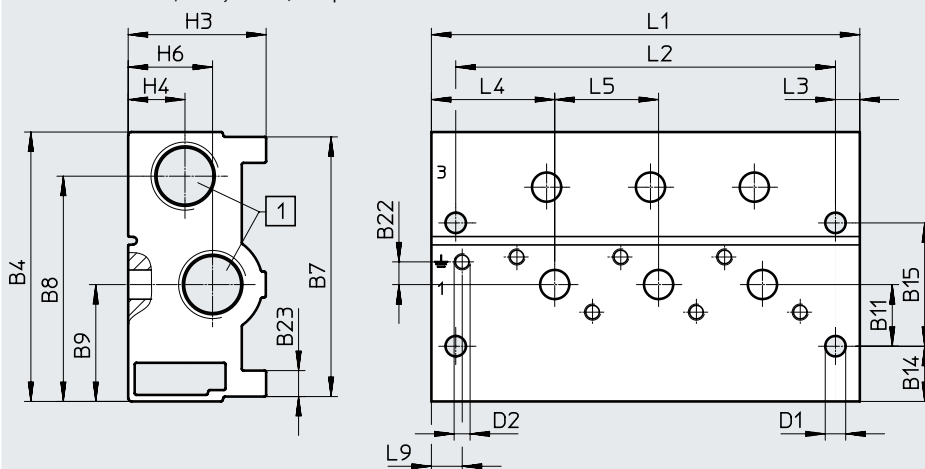

[1] Ports 1 and 3 (at both ends):  
G1/2

Type	B4	B7	B8	B9	B11	B14	B15	B22	B23
VABM-B10-30S-G12-...-P3	83	80	69.4	36	19	17	38	7	8

Type	D1 ø	D2	H3	H4	H6	L3	L4	L5	L9
VABM-B10-30S-G12-...-P3	6.3	M5x11	42.5	17.5	26	7.5	38	32	12

Valve positions	2	3	4	5	6	7	8	9	10
L1 [mm]	100	132	164	196	228	260	292	324	356
L2 [mm]	85	117	149	181	213	245	277	309	341

Data sheet – Manifold block, size 30

**Dimensions**

Manifold block for 5/2- and 5/3-way valves, compact

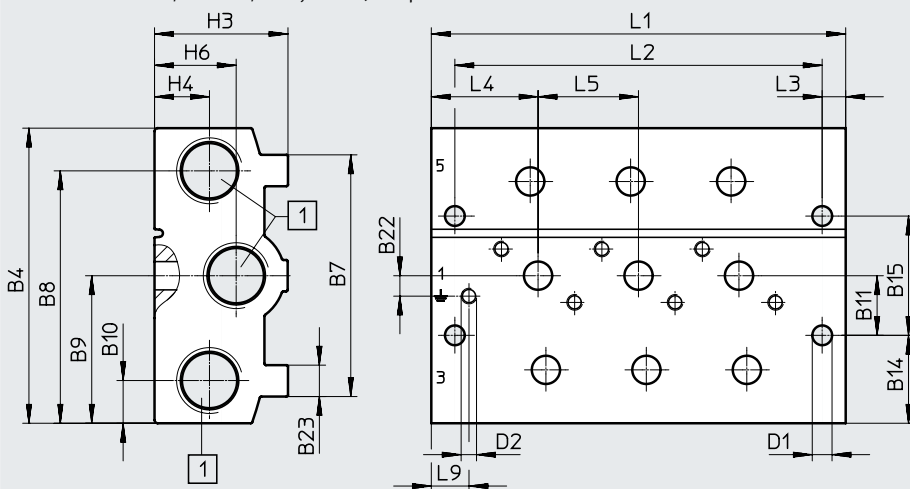

[1] Ports 1, 3 and 5 (at both ends):  
G1/2

Type	B4	B7	B8	B9	B10	B11	B14	B15	B22	B23
VABM-B10-30S-G12-...	94	77	80.4	47	13.6	19	28	38	6.5	10

Type	D1 ø	D2	H3	H4	H6	L3	L4	L5	L9
VABM-B10-30S-G12-...	6.3	M5x11	42.5	17.5	26	7.5	34	32	12

Valve positions	2	3	4	5	6	7	8	9	10
L1 [mm]	100	132	164	196	228	260	292	324	356
L2 [mm]	85	117	149	181	213	245	277	309	341



### Data sheet – Manifold block, size 30

#### Dimensions

Common supply manifold, mounting on both sides

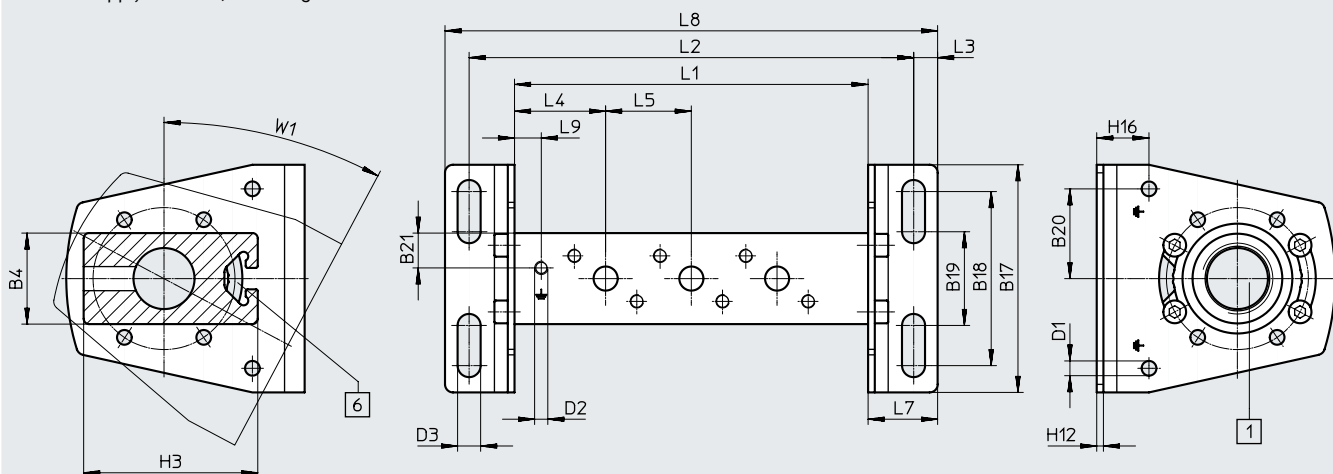

[1] Port 1 (at both ends): G3/4

[6] Profile slot IPM-08, system 8

**Note**

Mounting bracket can be adjusted through  $\pm 30^\circ$

Type	B4	B17	B18	B19	B20	B21	D1 $\varnothing$	D2	D3 $\varnothing$	H3	H12	H16	L3	L4	L5	L7	L9	W1
VABM-B10-30-G34-...-P53	34	85	65	35	33.5	13	5.5	M5x11	8.6	65	2.5	19.5	9	34	32	26	10	28°

Valve positions	2	3	4	5	6	7	8	9	10
L1 [mm]	100	132	164	196	228	260	292	324	356
L2 [mm]	134	166	198	230	262	294	326	358	390
L8 [mm]	152	184	216	248	280	312	344	376	408

#### Dimensions

Common supply manifold, mounting on one side

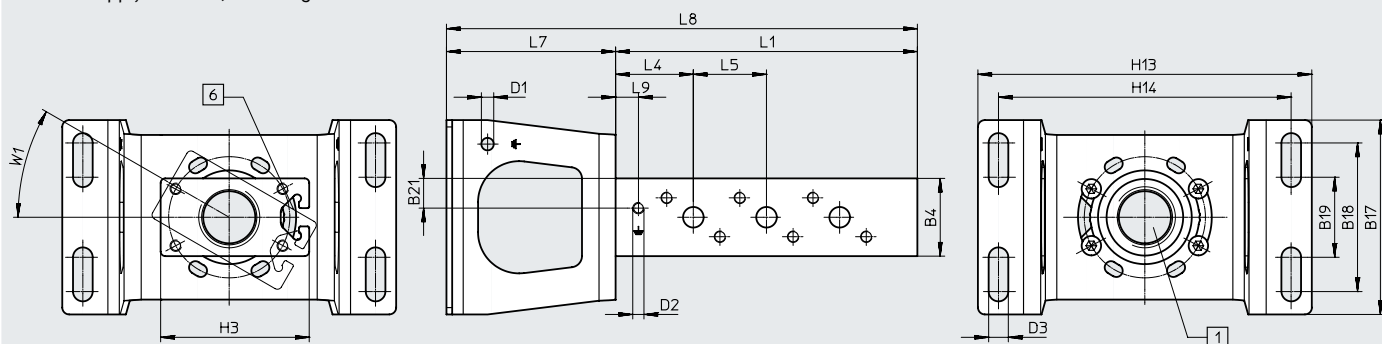

[1] Port 1 (at both ends): G3/4

[6] Profile slot IPM-08, system 8







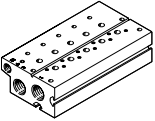

**Note**

Mounting bracket can be adjusted through  $\pm 30^\circ$

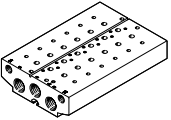
Type	B4	B17	B18	B19	B21	D1 $\varnothing$	D2	D3 $\varnothing$	H3	H13	H14	L4	L5	L7	L9	W1
VABM-B10-30-G34-...-P53-E	34	85	65	35	13	5.5	M5x11	8.6	65	146	128	34	32	74	10	30°

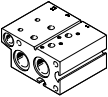
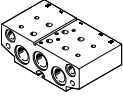
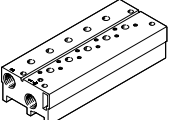
Valve positions	2	3	4
L1 [mm]	100	132	164
L8 [mm]	168	200	232

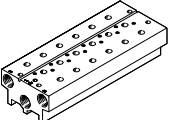
Ordering data – Manifold block, size 30

Ordering data	Description	Valve positions	Part no.	Type
<b>Standard manifold block</b>				
	For 3/2-way valves, incl. seals and screws for mounting valves  -  - <b>Note</b> Blanking plugs for sealing the supply ports (1, 3 and 14) at one end are included in the scope of delivery.	2	8026395	VABM-B10-30E-G34-2-P3
		3	8026396	VABM-B10-30E-G34-3-P3
		4	8026397	VABM-B10-30E-G34-4-P3
		5	8026398	VABM-B10-30E-G34-5-P3
		6	8026399	VABM-B10-30E-G34-6-P3
		7	8026400	VABM-B10-30E-G34-7-P3
		8	8026401	VABM-B10-30E-G34-8-P3
		9	8026402	VABM-B10-30E-G34-9-P3
		10	8026403	VABM-B10-30E-G34-10-P3
			For 5/2 and 5/3-way valves, incl. seals and screws for valve assembly  -  - <b>Note</b> Blanking plugs for sealing the supply ports (1, 3, 5, 12 and 14) at one end are included in the scope of delivery.	2
3	8026360			VABM-B10-30E-G34-3
4	8026361			VABM-B10-30E-G34-4
5	8026362			VABM-B10-30E-G34-5
6	8026363			VABM-B10-30E-G34-6
7	8026364			VABM-B10-30E-G34-7
8	8026365			VABM-B10-30E-G34-8
9	8026366			VABM-B10-30E-G34-9
10	8026367			VABM-B10-30E-G34-10
<b>Manifold block, extension module for standard manifold block</b>				
	For 3/2-way valves, incl. seals and screws for mounting valves	2	8026432	VABM-B10-30EEE-G34-2-P3
	For 5/2 and 5/3-way valves, incl. seals and screws for valve assembly	2	8026431	VABM-B10-30EEE-G34-2
<b>Compact manifold block</b>				
	For 3/2-way valves, incl. seals and screws for mounting valves  -  - <b>Note</b> Blanking plugs for sealing the supply ports (1 and 3) at one end are included in the scope of delivery.	2	8026413	VABM-B10-30S-G12-2-P3
		3	8026414	VABM-B10-30S-G12-3-P3
		4	8026415	VABM-B10-30S-G12-4-P3
		5	8026416	VABM-B10-30S-G12-5-P3
		6	8026417	VABM-B10-30S-G12-6-P3
		7	8026418	VABM-B10-30S-G12-7-P3
		8	8026419	VABM-B10-30S-G12-8-P3
		9	8026420	VABM-B10-30S-G12-9-P3
		10	8026421	VABM-B10-30S-G12-10-P3
			For 5/2 and 5/3-way valves, incl. seals and screws for valve assembly  -  - <b>Note</b> Blanking plugs for sealing the supply ports (1, 3 and 5) at one end are included in the scope of delivery.	2
3	8026378			VABM-B10-30S-G12-3
4	8026379			VABM-B10-30S-G12-4
5	8026380			VABM-B10-30S-G12-5
6	8026381			VABM-B10-30S-G12-6
7	8026382			VABM-B10-30S-G12-7
8	8026383			VABM-B10-30S-G12-8
9	8026384			VABM-B10-30S-G12-9
10	8026385			VABM-B10-30S-G12-10



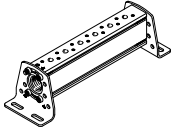
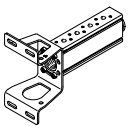

## Ordering data – Manifold block, size 30

Ordering data	Description	Valve positions	Part no.	Type
<b>Common supply manifold</b>				
	For mounting on both sides, incl. seals and screws for valve mounting	2	8026338	VABM-B10-30-G34-2-P53
		3	8026339	VABM-B10-30-G34-3-P53
		4	8026340	VABM-B10-30-G34-4-P53
		5	8026341	VABM-B10-30-G34-5-P53
		6	8026342	VABM-B10-30-G34-6-P53
		7	8026343	VABM-B10-30-G34-7-P53
		8	8026344	VABM-B10-30-G34-8-P53
		9	8026345	VABM-B10-30-G34-9-P53
		10	8026346	VABM-B10-30-G34-10-P53
			For mounting on one side, incl. seals and screws for valve mounting	2
3	8026357			VABM-B10-30-G34-3-P53-E
4	8026358			VABM-B10-30-G34-4-P53-E



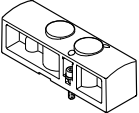
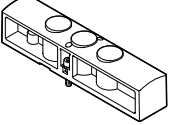

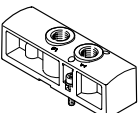
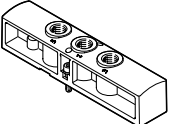
 **Note**

Blanking plug for sealing the supply port (1) at one end included in the scope of delivery.

Accessories – Manifold block, size 30



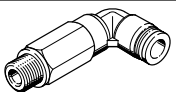

Ordering data	Description	Weight [g]	Part no.	Type
<b>Blanking plate</b>				
	For valve position on manifold block for 3/2-way valves	128	8026336	VABB-B10-30-E-P3
	For valve position on manifold block for 5/2-, 5/3-way valves	179	8026335	VABB-B10-30-E
	For valve position on common supply manifold	43	8026334	VABB-B10-30-A
<b>Supply plate</b>				
	For valve position on manifold block for 3/2-way valves	121	8026435	VABF-B10-30-P1A4-G38-P3
	For valve position on manifold block for 5/2-, 5/3-way valves	167	8026434	VABF-B10-30-P1A4-G38
	For valve position on common supply manifold	40	8026433	VABF-B10-30-P1-G38

### Accessories – Manifold block, size 30

Ordering data		Description	Part no.	Type	PU <sup>1)</sup>
<b>Push-in fitting with internal hex</b>					
	Connecting thread G1/8 for tubing O.D.	4 mm	186106	QS-G1/8-4-I	10
			133008	QS-G1/8-4-I-100	100
		6 mm	186107	QS-G1/8-6-I	10
			133009	QS-G1/8-6-I-100	100
	Connecting thread G3/8 for tubing O.D.	8 mm	186111	QS-G3/8-8-I	10
		10 mm	186113	QS-G3/8-10-I	10
		12 mm	186114	QS-G3/8-12-I	10
Connecting thread G1/2 for tubing O.D.	12 mm	186115	QS-G1/2-12-I	1	
<b>Push-in fitting with external hex</b>					
	Connecting thread G1/2 for tubing O.D.	16 mm	186105	QS-G1/2-16	1
			132047	QS-G1/2-16-20	20
<b>Angled push-in fitting with external hex</b>					
	Connecting thread G3/8 for tubing O.D.	8 mm	186121	QSL-G3/8-8	10
			132055	QSL-G3/8-8-50	50
		10 mm	186123	QSL-G3/8-10	10
			132056	QSL-G3/8-10-20	20
		12 mm	186124	QSL-G3/8-12	10
			132057	QSL-G3/8-12-20	20
	Connecting thread G1/2 for tubing O.D.	12 mm	186125	QSL-G1/2-12	1
			132058	QSL-G1/2-12-20	20
16 mm	186126	QSL-G1/2-16	1		
	132059	QSL-G1/2-16-20	20		
<b>Angled push-in fitting, long, with external hex</b>					
	Connecting thread G1/2 for tubing O.D.	8 mm	186132	QSL-G3/8-8	10
		10 mm	186134	QSL-G3/8-10	10
		12 mm	186135	QSL-G3/8-12	10
<b>Barbed fitting with external hex</b>					
	Connecting thread G3/4 for tubing I.D. Aluminium design	13 mm	3612	N-3/4-P-13	1
		19 mm	3613	N-3/4-P-19	1
	Connecting thread G3/4 for tubing I.D. Brass design	13 mm	15637	N-3/4-P-13-MS	1
		19 mm	15638	N-3/4-P-19-MS	1

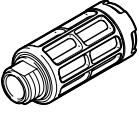
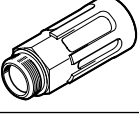
1) Packaging unit

Accessories – Manifold block, size 30

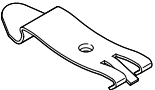
Ordering data	Description	Part no.	Type	PU <sup>1)</sup>
<b>Silencer</b>				
	With connecting thread G, polymer design	G3/8	<b>534224</b> U-3/8-20	20
	With connecting thread G, metal design	G3/8	<b>6843</b> U-3/8-B	1
		G1/2	<b>6844</b> U-1/2-B	1
		G3/4	<b>6845</b> U-3/4-B	1
	With connecting thread G, sintered design, long	G1/2	<b>1205863</b> AMTE-M-LH-G12	10
		G3/4	<b>1205864</b> AMTE-M-LH-G34	10
<b>Blanking plug</b>				
	With connecting thread G	G1/8	<b>3568</b> B-1/8	10
			<b>534213</b> B-1/8-100	100
		G1/2	<b>3571</b> B-1/2	10
			<b>534216</b> B-1/2-20	20
		G3/4	<b>3572</b> B-3/4	1
<b>Separator</b>				
	For creating pressure zones	G1/8	<b>569995</b> VABD-8-B	1
		G1/2	<b>8022483</b> VABD-17.5-B	1
		G3/4	<b>8022484</b> VABD-22.7-B	1
<b>H-rail mounting</b>				
	For size 30, for mounting on standard H-rails TH 35-7.5 or TH 35-15 to EN 60715	<b>3488412</b>	VAME-T-M6	2

1) Packaging unit