

- Electrically or pneumatically actuated valves
- With internal or external pilot air
- Pneumatic or mechanical reset
- Pressure regulator plate, flow control plate, vertical isolating plate and vertical supply plate as a vertical stacking construction
- Combi manifold with widths of 18 mm and 26 mm
- Electrical connection via round or square plug socket

Solenoid valves VSVA, ISO 15407-1

Key features

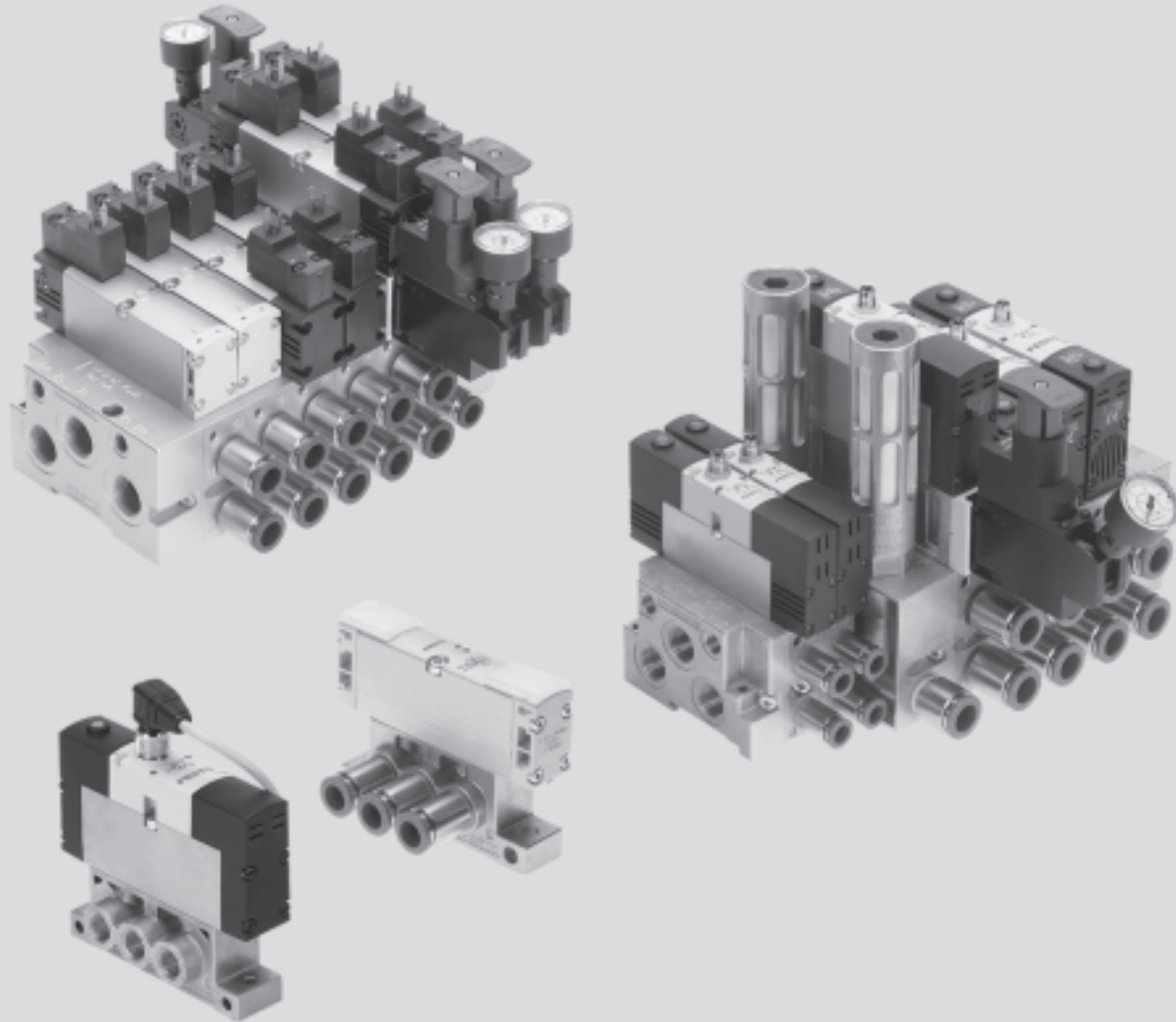

Innovative

- High-performance valves in sturdy metal housing
- Individual electrical connection via square plug sockets or centrally for each valve via round plug sockets
- Valve replacement under pressure possible using vertical shut-off plate
- Reverse operation
- Vacuum operation

Flexible

- Modular system offering a range of configuration options
- Conversions and extensions are possible at any time
- Integration of innovative function modules possible
 - Pressure regulator plate
 - Flow control plate
 - Vertical shut-off plate
 - Vertical supply plate
- Vertical supply plates permit a flexible air supply and variable pressure zones
- Wide range of valve functions
- Extensive operating voltage range from 12 V DC to 230 V AC

Reliable

- Sturdy and durable metal components
 - Valves
 - Horizontal stacking plates
 - Vertical stacking plates
- Fast troubleshooting thanks to LED in the plug socket or illuminating seal
- LED integrated in the valve with the round plug variant
- Reliability of service thanks to valves that can be replaced easily and quickly
- Manual override
- Durable thanks to the use of tried-and-tested piston spool valves

Easy to assemble

- Secure wall mounting or H-rail mounting
- Combi manifolds of width 18 mm and 26 mm
- Plug-in pressure gauges on the pressure regulator

Solenoid valves VSVA, ISO 15407-1

Key features

FESTO

Individual valve manifold

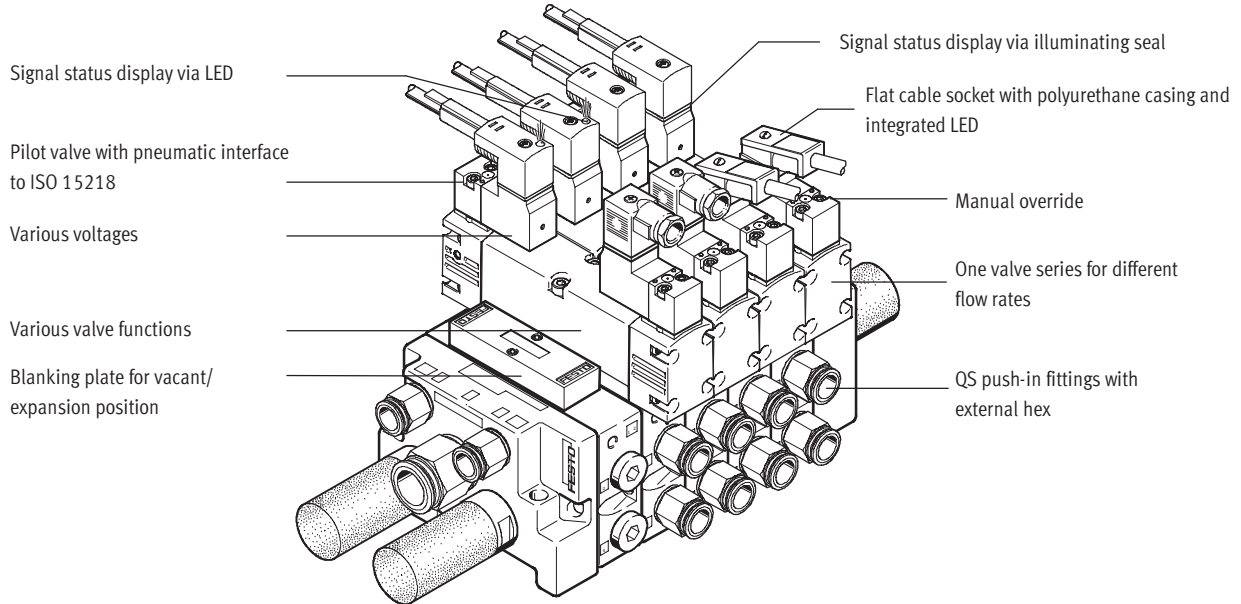

Equipment options

5/2-way valve	2x 3/2-way valve, single solenoid	2x 3/2-way valve, double solenoid	5/3-way valve, double solenoid
<ul style="list-style-type: none"> • Single solenoid, pneumatic or spring return • Bistable, double solenoid valve • Bistable, double solenoid valve with dominance at 14 	<ul style="list-style-type: none"> • Normally open • Normally open, reversible (on request) • Normally closed • Normally closed, reversible (on request) 	<ul style="list-style-type: none"> • 1x normally open, 1x normally closed • 1x normally open, 1x normally closed, reversible (on request) 	<ul style="list-style-type: none"> • Mid-position valve <ul style="list-style-type: none"> – Normally open – Normally closed – Normally exhausted

Special features

Operation with external pilot air	Operation with internal pilot air	Reverse operation with pressure supply via ducts 3 and 5	Reverse operation with a pressure regulator plate, compressed air supply via duct 1
<ul style="list-style-type: none"> • For vacuum applications • For working pressures lower than 3 bar • For pressure fluctuations in the power section. Power section and pneumatic control section are decoupled • For strongly lubricated air in the power section • For manifolds if the pressure zones are created via ducts 3 and 5 (not possible with 2x 3/2) • For manifolds or pressure zones that are equipped with reversible 2x 3/2-way valves 	<ul style="list-style-type: none"> • For small pressure fluctuations in the power section • For using pressure regulator plates in a vertical stacking construction, also in reverse operation • As a low-cost solution 	<ul style="list-style-type: none"> • Pressure zone separation via ducts 3 and 5 <ul style="list-style-type: none"> – Example: Duct 3 vacuum, duct 5 ejector pulse – Example: Duct 3 high pressure for advancing the piston rod of a double-acting cylinder. Duct 5 low pressure for retracting the piston rod with low energy consumption • 2x 3/2-way valves used as 5/4-way valve with controllable overlapping with the reversible variant 	<ul style="list-style-type: none"> • Reversible pressure regulator combined with a reversible 2x 3/2-way valve regulates outputs 2 and 4 <ul style="list-style-type: none"> – AB regulator for outputs 2 and 4 – A regulator for output A – B regulator for output 2 • Reversible pressure regulators are in the control position immediately after the power supply is switched on <ul style="list-style-type: none"> – Adjustment possible at all times – Dynamic response characteristics – Reduced regulator load because the supply pressure is maintained when the valve is switched – Venting not via the regulator

Solenoid valves VSVA, ISO 15407-1

Key features



Valve manifold with combination of sizes and vertical stacking

Solenoid valve with individual pilot valves and pneumatic interface to ISO 15218. Can be connected with square plug sockets

Widths of 18 mm and 26 mm can be combined

Solenoid valve with central round plug

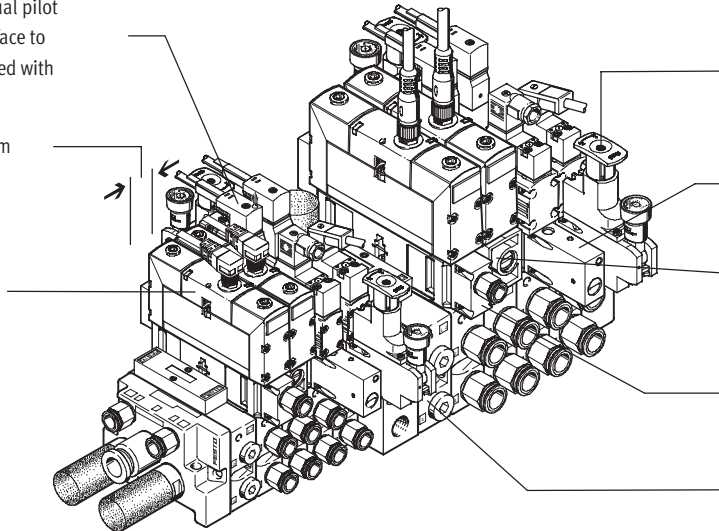

Pressure regulator for adjusting the force of the actuated drive

Pressure shut-off plate for solenoid valve replacement during operation

Flow control plate in the valve manifold for adjusting the speed of the drive

Supply plate for compressed air supply of a control chain as a separate pressure zone

Intermediate plate as interface between width 18 mm and width 26 mm

Vertical stacking function

Pressure regulator

- Single variant to regulate the pressure at output 4(A) or 2(B) or at input 1(P)
- Dual variant to regulate the pressure at output 4(A) and 2(B) individually
- Reverse variant for the outputs so that the regulator is in the control position
- With pressure gauge connection

Flow control plate

- Designed with two flow control valves, on which the exhaust air flow rate at exhausts 5 or 3 can be adjusted. The movement of the drive can thus be initiated and the desired speed set on the manifold using the manual override

Vertical shut-off plate

- Equipped with a switch via which the compressed air supply can be shut off. A directional control valve or subsequent vertical stacking plate can thus be replaced without switching off the overall air supply
- If the control chain has a redundant connection, the cycle can continue in the case of a cyclical control system

Vertical supply plate

- As additional air supply for one valve
- To supply a third pressure zone

Individual connection with square plug, type C

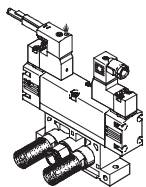

The directional control valve has a pilot control to ISO 15218 and a plug pattern to DIN EN 175301-803, type C.

Individual connection with central round plug

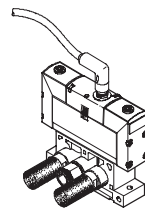

The electrical connection is established using a standardised M12 or M8 socket 24 V DC (EN 61076-2-101).

Solenoid valves VSVA, ISO 15407-1

Key features

Individual valve manifold, directional control valves with square plug, type C

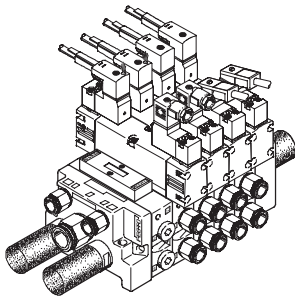

- Variant
- Width 26 mm
 - Vacant position
 - Compressed air supply via duct 1
 - External pilot air supply
 - QS push-in fittings
 - Venting via silencer for ducts 3 and 5

Individual valve manifold, pressure zones via ducts 3 and 5

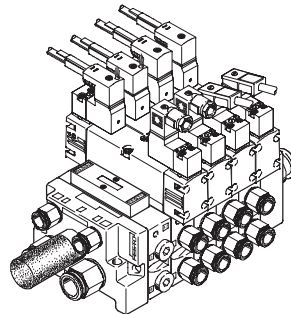

- Variant
- Width 26 mm
 - Vacant position
 - Compressed air supply via ducts 3 and 5
 - External pilot air supply
 - QS push-in fittings
 - Venting via silencer

Valve manifold equipped with width 18 mm and 26 mm, directional control valves with square plug, type C

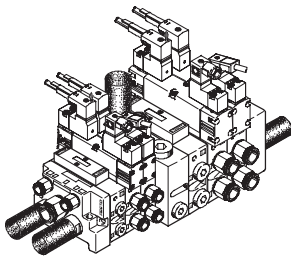

- Variant
- Width 18 mm and 26 mm combined via intermediate plate
 - Vacant positions
 - Compressed air supply via duct 1
 - External pilot air supply
 - QS push-in fittings
 - Venting via silencer for ducts 3 and 5 on the end plates and for duct 3 also on the intermediate plate

Valve manifold equipped with width 18 mm and 26 mm, directional control valves with central round plug

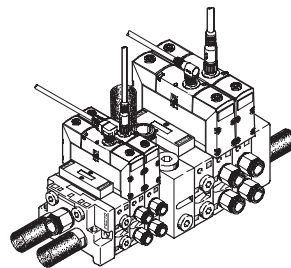

- Variant
- Width 18 mm and 26 mm combined via intermediate plate
 - Vacant positions
 - Compressed air supply via duct 1
 - Internal pilot air supply
 - QS push-in fittings
 - Venting via silencer for ducts 3 and 5 on the end plates and for duct 3 also on the intermediate plate

Maximum valve manifold expansion with all vertical stacking components

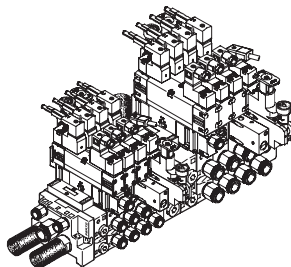

- Variant
- Width 18 mm and 26 mm combined via intermediate plate
 - Directional control valves with square plug
 - Pressure regulators
 - Flow control plates
 - Shut-off plates
 - Supply plates with vacant position

Individual valve manifold with cable routing in one direction

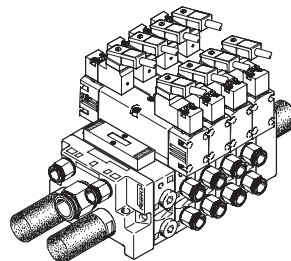

- Variant
- Width 26 mm
 - Solenoid coils 220 V DC
 - Plug socket with cable KMEB-2 – With plug socket with cable KMEB-1 the outgoing direction of the cable cannot be chosen with AC coils

Pneumatically actuated directional control valve on individual sub-base

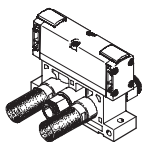

Directional control valves on an individual sub-base can be used for drives that are further away from a valve manifold or when there is only one drive available.

Valve manifold equipped with width 18 mm and 26 mm with pneumatically actuated directional control valves

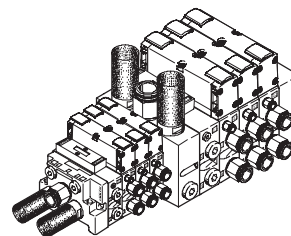

- Variant
- Width 18 mm and 26 mm combined via intermediate plate
 - Vacant positions
 - Compressed air supply via duct 1
 - QS push-in fittings
 - Venting via silencer for ducts 3 and 5 on the end plates and for ducts 3 and 5 also on the intermediate plate

Solenoid valves VSVA, ISO 15407-1

Key features

Solenoid valves with square plug, type C

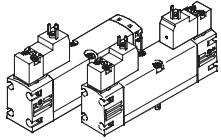

Designs

- Width 18 and 26 mm
- 2x 3/2-way, 5/2-way and 5/3-way valves
- 2x 3/2-way valves for reverse operation
- Internal or external pilot air supply available
- 12, 24 V DC, 24, 110 or 220 V AC

Solenoid valves with central round plug

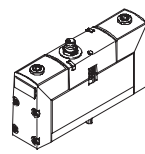

Variants

- Width 18 and 26 mm
- 2x 3/2-way, 5/2-way and 5/3-way valves
- Internal or external pilot air supply available
- 24 V DC

Basic valves with interface to ISO 15218

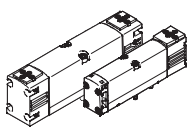

Variants

- Width 18 and 26 mm
- 2x 3/2-way, 5/2-way and 5/3-way valves
- Internal or external pilot air supply available

Pilot valve with interface to ISO 15218

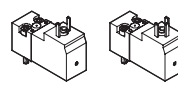

Variants

- For 12, 24 V DC and 24 V AC without protective earth conductor
- For 110 and 220 V AC with protective earth conductor
- 3/2-way valve
- Manual override, non-detenting

Pneumatically actuated directional control valves

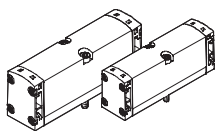

Variants

- Width 18 and 26 mm
- 2x 3/2-way, 5/2-way and 5/3-way valves
- Signal inputs 12 and 14 via the sub-base

Individual sub-base

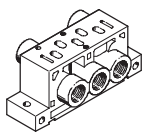

Variants

- Width 18 and 26 mm
- Ports 12 and 14 for external pilot air supply for solenoid valves and
- Ports signal inputs 12 and 14 for pneumatically actuated valves are the same

Blanking plate for vacant positions

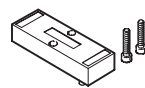

Variants

- Width 18 and 26 mm

End plate kit

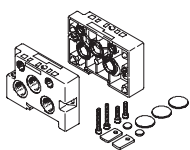

Variants

- Width 18 mm and 26 mm
- Ports 12 and 14 for external pilot air supply for solenoid valves
- For pneumatically actuated valves the signal inputs are only on the manifold sub-base suitable for this purpose

Manifold sub-base/series sub-base

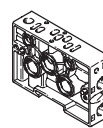

Variants

- Width 18 mm and 26 mm
- For solenoid valves
- For pneumatically actuated valves with additional ports for the signal inputs

Intermediate plate

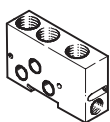

Variant

- Adapter between width 18 mm and 26 mm
- With additional sir supply port and exhaust ports

Intermediate plate kit

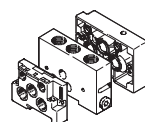

Variant

- Intermediate plate as adapter between width 18 mm and 26 mm
- One 18 mm and one 26 mm end plate

Solenoid valves VSVA, ISO 15407-1

Key features

Pressure regulator plate with one pressure regulator

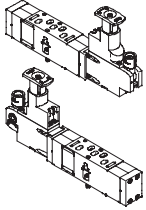

Variants

- Width 18 mm and 26 mm
- For pressure regulation on the supply input 1(P). Set pressure is the same for output 2 and 4
- For pressure regulation on the working port 4 (A)
 - The pressure regulators for reverse operation are supplied via port 1 of the sub-base and supply port 5 on the directional control valve
 - The directional control valve vents via port 1 to port 3 and 5 of the sub-base.
- For pressure regulation on the working port 2 (B)
 - In reverse operation input 3 is supplied here

Pressure regulator plate with two pressure regulators

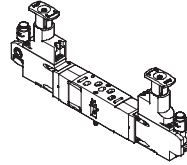

Variants

- Width 18 mm and 26 mm
- For pressure regulation on the working ports 4 (A) and 2 (B)
 - The pressure regulators for reverse operation are supplied via port 1 of the sub-base and supply inputs 5 and 3 on the directional control valve
 - The directional control valve vents via port 1 to port 3 and 5 of the sub-base.

Vertical supply plate

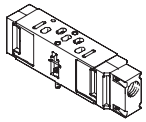

Variants

- Width 18 mm and 26 mm
- As intermediate supply
 - For one valve
 - To supply a third pressure zone
- Can be equipped with a directional control valve

Flow control plate

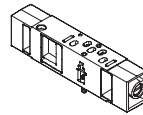

Variants

- Width 18 mm and 26 mm
- Exhaust air restriction in ducts 3 and 5
 - For pressure zones that are formed via ducts 3 and 5 the flow control plates function as supply air restrictors

Vertical shut-off plate

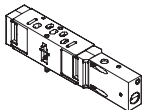

Variants

- Width 18 mm and 26 mm
- A switch activated with a slotted head screwdriver shuts off duct 1.
 - The overlying flow control plates, pressure regulator plates or directional control valves can be replaced
 - Other components of the control chain such as drives, for example, can be replaced following venting via the directional control valve

Pressure gauge



Variant

- Can be connected to the pressure regulator plates

Solenoid valves VSVA, ISO 15407-1

Key features

Port pattern on sub-base to ISO 15407-1

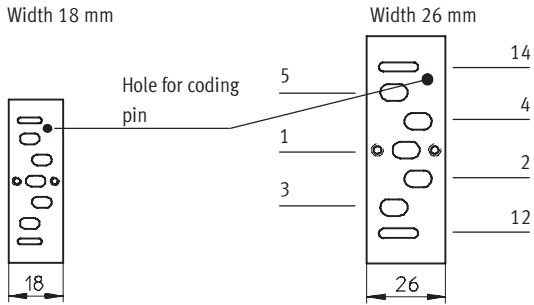

VSVA

Conversion of pilot air venting

VSVA valve manifolds are supplied with unducted ventilation of the pilot air. By turning the seal between the

valve and manifold block, ventilation (pilot air) can be diverted into the

pilot duct 12 and it can thus be contained and silenced (see Figure).

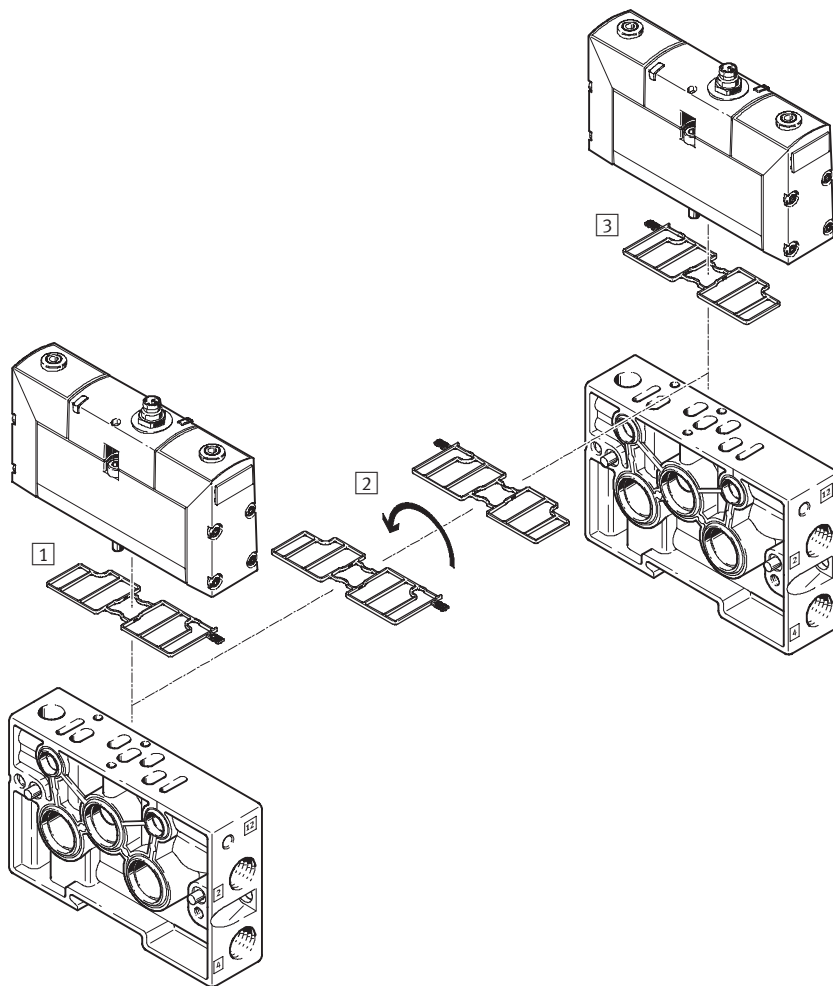

- 1 Ducted pilot air venting
- 2 Turning of seal by 180°
- 3 Unducted pilot air venting (as supplied)

Solenoid valves VSVA, ISO 15407-1

Key features



Application of 2x 3/2-way valve as 5/4-way valve																			
Code	Circuit symbol	Value table	Equivalent circuit symbol	Function															
K		<table border="1"> <thead> <tr> <th>Y1</th> <th>Y2</th> <th>A</th> </tr> </thead> <tbody> <tr> <td>0</td> <td>0</td> <td></td> </tr> <tr> <td>0</td> <td>1</td> <td></td> </tr> <tr> <td>1</td> <td>0</td> <td></td> </tr> <tr> <td>1</td> <td>1</td> <td></td> </tr> </tbody> </table>	Y1	Y2	A	0	0		0	1		1	0		1	1			<ul style="list-style-type: none"> • Normally exhausted • A double-acting drive connected to outputs 2 and 4 is unpressurised when the valve is in the normal position and can be moved by an external force • If there is a signal present at Y1(14) and Y2(12), there is pressure at outputs 2 and 4
Y1	Y2	A																	
0	0																		
0	1																		
1	0																		
1	1																		
		<table border="1"> <thead> <tr> <th>Y1</th> <th>Y2</th> <th>A</th> </tr> </thead> <tbody> <tr> <td>0</td> <td>0</td> <td></td> </tr> <tr> <td>0</td> <td>1</td> <td></td> </tr> <tr> <td>1</td> <td>0</td> <td></td> </tr> <tr> <td>1</td> <td>1</td> <td></td> </tr> </tbody> </table>	Y1	Y2	A	0	0		0	1		1	0		1	1			<ul style="list-style-type: none"> • Normally closed (by combining directional control valve code K and two piloted non-return valves) • The piloted non-return valves connected to outputs 2 and 4 are unpressurised when the valve is in the normal position and the pressures in the drive close the non-return valves leak-tight • The drive stops when the forces are in equilibrium • Leakages can only occur via the drive seals • If there is a signal present at Y1(14) and Y2(12), the same pressure is present at outputs 2 and 4
Y1	Y2	A																	
0	0																		
0	1																		
1	0																		
1	1																		
N		<table border="1"> <thead> <tr> <th>Y1</th> <th>Y2</th> <th>A</th> </tr> </thead> <tbody> <tr> <td>0</td> <td>0</td> <td></td> </tr> <tr> <td>0</td> <td>1</td> <td></td> </tr> <tr> <td>1</td> <td>0</td> <td></td> </tr> <tr> <td>1</td> <td>1</td> <td></td> </tr> </tbody> </table>	Y1	Y2	A	0	0		0	1		1	0		1	1			<ul style="list-style-type: none"> • Normally open • A double-acting drive connected to outputs 2 and 4 is fed with the same compressed air at both ends when the valve is in the normal position and stops when the forces are in equilibrium • If there is a signal present at Y1(10) and Y2(10), outputs 2 and 4 are exhausted, the drive is unpressurised and can be moved by an external force
Y1	Y2	A																	
0	0																		
0	1																		
1	0																		
1	1																		
H		<table border="1"> <thead> <tr> <th>Y1</th> <th>Y2</th> <th>A</th> </tr> </thead> <tbody> <tr> <td>0</td> <td>0</td> <td></td> </tr> <tr> <td>0</td> <td>1</td> <td></td> </tr> <tr> <td>1</td> <td>0</td> <td></td> </tr> <tr> <td>1</td> <td>1</td> <td></td> </tr> </tbody> </table>	Y1	Y2	A	0	0		0	1		1	0		1	1			<ul style="list-style-type: none"> • Normally open after output 2 • A double-acting drive connected to outputs 2 and 4 is fed with compressed air via output 2 when the valve is in the normal position. Output 4 is exhausted. The drive is thus in a clearly defined position in the initial position, as would also be the case with a single solenoid 5/2-way valve • If there is a signal present at Y1(14) and Y2(10), output 2 is exhausted and pressure is fed to output 4. The drive leaves the initial position • With this 2x 3/2-way valve a closed circuit can be created by combining it with piloted non-return valves. However, this is then selected by an active signal at Y2(10)
Y1	Y2	A																	
0	0																		
0	1																		
1	0																		
1	1																		

Solenoid valves VSVA, ISO 15407-1

Product range overview

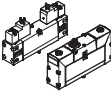
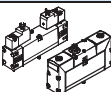
Function	Variant	Type	Flow rate of valve	Working port on sub-base		Operating voltage					
						[V DC]		[V AC]			
						[l/min]	G $\frac{1}{8}$	G $\frac{1}{4}$	12	24	24
2x 3/2-way valves in one housing	Width 18 mm, single solenoid valve										
		VSVA-B-T32...A2...C...	600	■	-	■	■	■	■	■	■
		VSVA-B-T32...-A2...R...	600	■	-	-	■	-	-	-	-
	Width 26 mm, single solenoid valve										
	VSVA-B-T32...A1...C...	1,250	-	■	■	■	■	■	■	■	
	VSVA-B-T32...A1...R...	1,250	-	■	-	■	-	-	-	-	

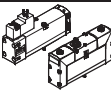
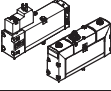
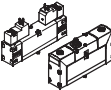
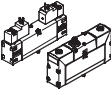
Function	Variant	Type	Flow rate of valve	Working port on sub-base		Operating voltage					
						[V DC]		[V AC]			
						[l/min]	G $\frac{1}{8}$	G $\frac{1}{4}$	12	24	24
5/2-way valve, single solenoid	Width 18 mm, single solenoid valve										
		VSVA-B-M52...A2...C...	750	■	-	■	■	■	■	■	■
		VSVA-B-M52...A2...R...	750	■	-	-	■	-	-	-	-
	Width 26 mm, single solenoid valve										
	VSVA-B-M52...A1...C...	1,400	-	■	■	■	■	■	■	■	
	VSVA-B-M52...A1...R...	1,400	-	■	-	■	-	-	-	-	
5/2-way valve, double solenoid	Width 18 mm, double solenoid valve										
		VSVA-B-B52...A2...C...	750	■	-	■	■	■	■	■	■
		VSVA-B-B52...A2...R...	750	■	-	-	■	-	-	-	-
	Width 26 mm, double solenoid valve										
	VSVA-B-B52...A1...C...	1,400	-	■	■	■	■	■	■	■	
	VSVA-B-B52...A1...R...	1,400	-	■	-	■	-	-	-	-	

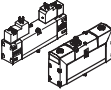
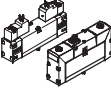
Function	Variant	Type	Flow rate of valve	Working port on sub-base		Operating voltage					
						[V DC]		[V AC]			
						[l/min]	G $\frac{1}{8}$	G $\frac{1}{4}$	12	24	24
5/3-way valve, double solenoid	Width 18 mm, mid-position valve										
		VSVA-B-P53...A2...C...	650	■	-	■	■	■	■	■	■
		VSVA-B-P53...-A2...R...	650	■	-	-	■	-	-	-	-
	Width 26 mm, mid-position valve										
	VSVA-B-P53...A1...C...	1,400	-	■	■	■	■	■	■	■	
	VSVA-B-P53...A1...R...	1,400	-	■	-	■	-	-	-	-	

Solenoid valves VSVA, ISO 15407-1

Product range overview

FESTO

Type	Plug			Pilot air		Pneumatic spring return	Normal position			→ Page
	Square	Central round		Internal	External		2x closed	2x open	1x open 1x closed	
	MEB	M8x1	M12x1							
Width 18 mm, single solenoid valve										
VSVA-B-T32...A2...C...	■	-	-	■	■	■	■	■	■	2 / 1.3-20
VSVA-B-T32...-A2...R...	-	■	-	■	■	■	■	■	■	2 / 1.3-36
Width 26 mm, single solenoid valve										
VSVA-B-T32...A1...C...	■	-	-	■	■	■	■	■	■	2 / 1.3-28
VSVA-B-T32...A1...R...	-	■	■	■	■	■	■	■	■	2 / 1.3-41

Type	Plug			Pilot air supply		Spring return		Signal processing			→ Page
	Square	Central round		Internal	External	Pneumatic	Mechanical	Single solenoid	Double solenoid/dominance		
	MEB	M8x1	M12x1						1st signal	At 14	
Width 18 mm, single solenoid valve											
VSVA-B-M52...A2...C...	■	-	-	■	■	■	■	■	-	-	2 / 1.3-20
VSVA-B-M52...A2...R...	-	■	-	■	■	■	■	■	-	-	2 / 1.3-36
Width 26 mm, single solenoid valve											
VSVA-B-M52...A1...C...	■	-	-	■	■	■	■	■	-	-	2 / 1.3-28
VSVA-B-M52...A1...R...	-	■	■	■	■	■	■	■	-	-	2 / 1.3-41
Width 18 mm, double solenoid valve											
VSVA-B-B52...A2...C...	■	-	-	■	■	-	-	-	■	■	2 / 1.3-20
VSVA-B-B52...A2...R...	-	■	-	■	■	-	-	-	■	■	2 / 1.3-36
Width 26 mm, double solenoid valve											
VSVA-B-B52...A1...C...	■	-	-	■	■	-	-	-	■	■	2 / 1.3-28
VSVA-B-B52...A1...R...	-	■	■	■	■	-	-	-	■	■	2 / 1.3-41

Type	Plug			Pilot air supply		Normal position			→ Page
	Square	Central round		Internal	External	Closed	Exhausted	Open	
	MEB	M8x1	M12x1						
Width 18 mm, mid-position valve									
VSVA-B-P53...A2...C...	■	-	-	■	■	■	■	■	2 / 1.3-20
VSVA-B-P53...-A2...R...	-	■	-	■	■	■	■	■	2 / 1.3-36
Width 26 mm, mid-position valve									
VSVA-B-P53...A1...C...	■	-	-	■	■	■	■	■	2 / 1.3-28
VSVA-B-P53...-A1...R...	-	■	■	■	■	■	■	■	2 / 1.3-41

Solenoid valves VSVA, ISO 15407-1

Product range overview

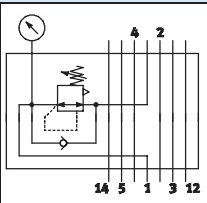
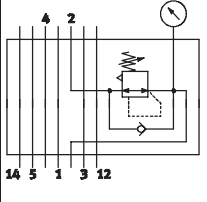
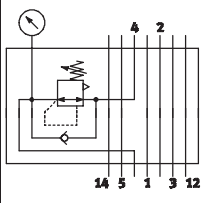
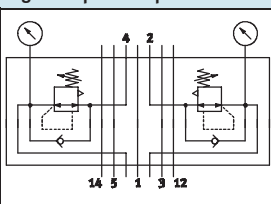
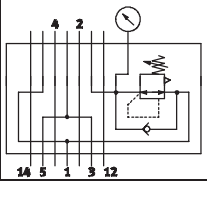
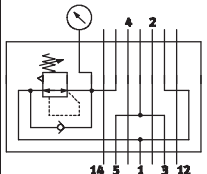
Vertical stacking – Pressure regulator plate								
Code	Circuit symbol	Type	Width		Input pressure		Description	→ Page
			18 mm	26 mm	6 bar	10 bar		
Pressure regulator plate for port 1								
ZA		VABF-S3-...-R1C2-C-10	■	■	-	■	<ul style="list-style-type: none"> Regulates the operating pressure in duct 1 before the directional control valve 	Width 18 2 / 1.3-46 Width 26 2 / 1.3-51
ZF		VABF-S3-...-R1C2-C-6	■	■	■	-		
Pressure regulator plate for port 2								
ZC		VABF-S3-...-R2C2-C-10	■	■	-	■	<ul style="list-style-type: none"> Regulates the operating pressure in duct 2 after the directional control valve 	Width 18 2 / 1.3-46 Width 26 2 / 1.3-51
ZH		VABF-S3-...-R2C2-C-6	■	■	■	-		
Pressure regulator plate for port 4								
ZB		VABF-S3-...-R3C2-C-10	■	■	-	■	<ul style="list-style-type: none"> Regulates the operating pressure in duct 4 after the directional control valve 	Width 18 2 / 1.3-46 Width 26 2 / 1.3-51
ZG		VABF-S3-...-R3C2-C-6	■	■	■	-		
Pressure regulator plate for ports 2 and 4								
ZD		VABF-S3-...-R4C2-C-10	■	■	-	■	<ul style="list-style-type: none"> Regulates the operating pressure in ducts 2 and 4 after the directional control valve 	Width 18 2 / 1.3-46 Width 26 2 / 1.3-51
ZI		VABF-S3-...-R4C2-C-6	■	■	■	-		
Pressure regulator plate for port 2, reversible								
ZL		VABF-S3-...-R6C2-C-10	■	■	-	■	<ul style="list-style-type: none"> Reversible pressure regulator for port 2 	Width 18 2 / 1.3-46 Width 26 2 / 1.3-51
ZN		VABF-S3-...-R6C2-C-6	■	■	■	-		
Pressure regulator plate for port 4, reversible								
ZK		VABF-S3-...-R7C2-C-10	■	■	-	■	<ul style="list-style-type: none"> Reversible pressure regulator for port 4 	Width 18 2 / 1.3-46 Width 26 2 / 1.3-51
ZM		VABF-S3-...-R7C2-C-6	■	■	■	-		

Solenoid valves VSVA, ISO 15407-1

Product range overview

FESTO

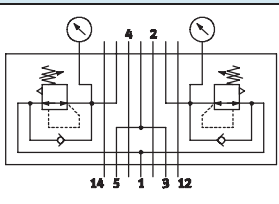
Vertical stacking – Pressure regulator plate								
Code	Circuit symbol	Type	Width		Input pressure		Description	→ Page
			18 mm	26 mm	6 bar	10 bar		
Pressure regulator plate for ports 2 and 4, reversible								
ZE		VABF-S3-...-R5C2-C-10	■	■	-	■	<ul style="list-style-type: none"> Reversible pressure regulator for ports 2 and 4 Pressure regulation before the valve Redirects the operating pressure from duct 1 to ducts 3 and 5 	Width 18 2 / 1.3-46 Width 26 2 / 1.3-51
ZJ		VABF-S3-...-R5C2-C-6	■	■	■	-	<ul style="list-style-type: none"> Routes the exhaust air from duct 1 to ducts 3 and 5 Can be combined with reversible 2x 3/2-way valves (code P, Q, R) 	

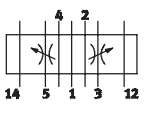
Vertical stacking – Flow control plate							
Code	Circuit symbol	Type	Width		Description	→ Page	
			18 mm	26 mm			
X		VABF-S3-...-F1B1-C	■	■	<ul style="list-style-type: none"> Controls the flow of exhaust air after the valve to ducts 3 and 5 	Width 18 2 / 1.3-48 Width 26 2 / 1.3-54	

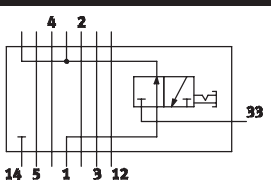
Vertical stacking – Vertical shut-off plate							
Code	Circuit symbol	Type	Width		Description	→ Page	
			18 mm	26 mm			
ZT		VABF-S3-...-L1D1-C	■	■	<ul style="list-style-type: none"> 2/2-way valve for shutting off the operating pressure at the valve position Blocks ducts 12 and 14 for the valve position Supplies the valve position with internal pilot air 	Width 18 2 / 1.3-50 Width 26 2 / 1.3-56	

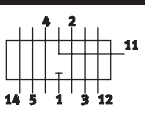
Vertical stacking – Vertical supply plate							
Code	Circuit symbol	Type	Width		Description	→ Page	
			18 mm	26 mm			
ZU		VABF-S3-...-P1A3-...	■	■	<ul style="list-style-type: none"> Plate with port 11 for supplying an individual operating pressure for a valve position 	Width 18 2 / 1.3-49 Width 26 2 / 1.3-55	

Solenoid valves VSVA, ISO 15407-1

Type codes

VSVA		-	B	-	T	32	C	-	A	Z	H	-	A1	-	1	C1		
Valve family																		
VSVA	Standard valves ISO 15407-1/-2																	
Valve type																		
B	Sub-base valve																	
Valve function																		
M	Single solenoid																	
B	Double solenoid																	
D	Double solenoid with dominance at 14																	
P	Double solenoid, mid-position																	
T	2 single solenoid valves in one housing																	
Connections / switching positions																		
32	3/2-way valve																	
52	5/2-way valve																	
53	5/3-way valve																	
Normal position																		
C	Closed																	
N	Code T with 2x closed, reverse operation																	
U	Open																	
F	Code T with 2x open, reverse operation																	
E	Exhausted																	
H	Code T with 1x open, 1x closed																	
W	Code T with 1x open, 1x closed, reverse operation																	
	Double solenoid valve																	
Reset method																		
A	Pneumatic spring																	
M	Mechanical spring																	
	Double solenoid valve																	
Pilot air supply																		
Z	External																	
	Internal																	
Manual override																		
H	Pushing (non-detenting)																	
Standard																		
A1	ISO size 01, width 26 mm																	
A2	ISO size 02, width 18 mm																	
Operating voltage																		
1	24 V DC																	
1A	24 V AC																	
2A	110 V AC																	
3A	230 V AC																	
5	12 V DC																	
Electrical connection																		
C1	Type C to DIN EN 175301-803																	
R2	Central plug M8x1																	
R5	Central plug M10x1																	
Signal status display																		
L	LED (integrated)																	

Solenoid valves VSVA, ISO 15407-1

Peripherals overview

Individual mounting

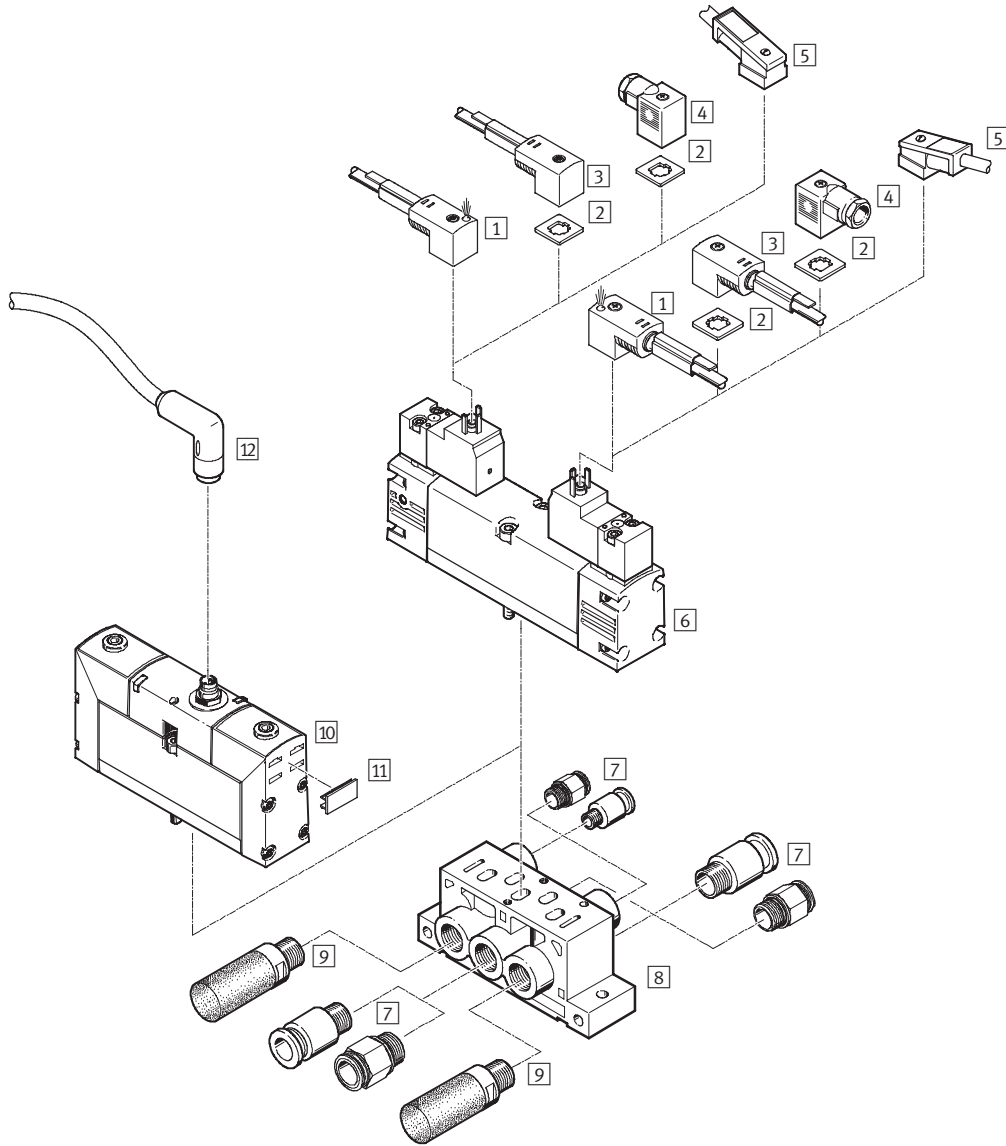

Component parts				
	Type	Brief description	→ Page	
1	Plug socket with cable	KMEB1-...-LED	With PVC casing and LED	2 / 1.3-77
2	Illuminating seal	MEB-LD	For indicating the signal status	2 / 1.3-78
3	Plug socket with cable	KMEB1-...	With PVC casing	2 / 1.3-77
4	Plug socket	MSSD-EB	-	2 / 1.3-77
5	Plug socket with cable	KMEB2-...-LED	With polyurethane casing and LED	2 / 1.3-77
6	Solenoid valve	VSVA-...C-...	With interface to ISO 15218 and plug pattern type C	2 / 1.3-20
7	Push-in fitting	QS-...	For standard O.D. tubing	→ Volume 3
8	Individual sub-base	NAS-...	With lateral ports	2 / 1.3-57
9	Silencer	U-...	For fitting in exhaust ports	→ Volume 3
10	Solenoid valve	VSVA-...R-...	With round plug	2 / 1.3-20
11	Inscription labels	IBS-9x20	For identifying the VSVA valves with round plug	2 / 1.3-77
12	Plug socket with cable	SIM-...	For valves with round plug	2 / 1.3-78

Solenoid valves VSVA, ISO 15407-1

System overview

Manifold assembly

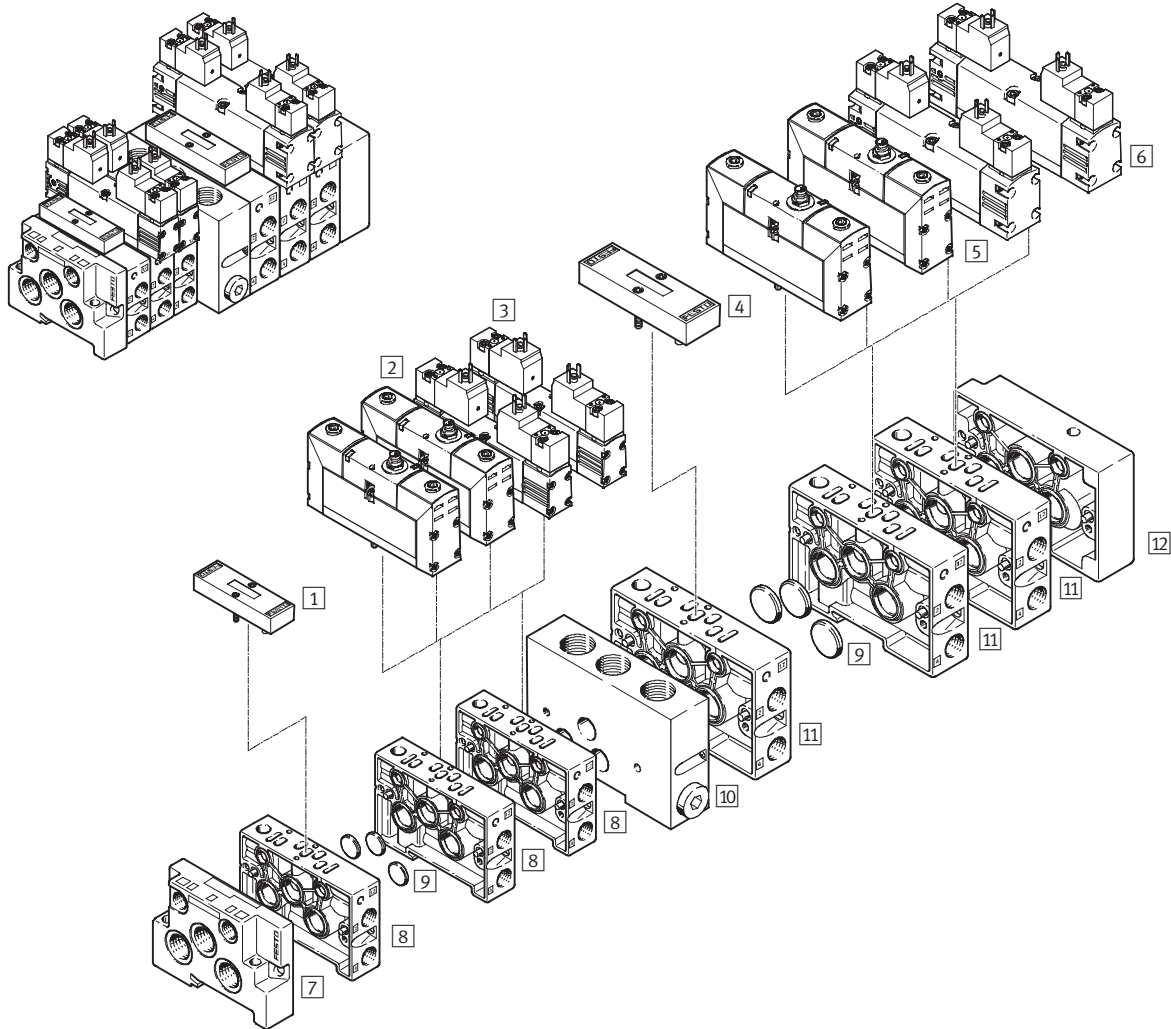

Standard directional control valves
ISO 15407-1

1.3

Component parts				
	Type	Brief description	→ Page	
1	Blanking plate	NDV-02-VDMA	For width 18 mm, vacant or spare position	2 / 1.3-65
2	Solenoid valve	VSVA...A2...R...	Width 18 mm with round plug	2 / 1.3-36
3	Solenoid valve	VSVA...A2...C...	Width 18 mm with interface to ISO 15218 and plug pattern type C	2 / 1.3-20
4	Blanking plate	NDV-01-VDMA	For width 26 mm, vacant or spare position	2 / 1.3-65
5	Solenoid valve	VSVA...A1...R...	Width 26 mm with round plug	2 / 1.3-41
6	Solenoid valve	VSVA...A1...C...	Width 26 mm with interface to ISO 15218 and plug pattern type C	2 / 1.3-28
7	End plate	NEV-...	For sealing the manifold sub-bases width 18 mm	2 / 1.3-58
8	Manifold sub-base	NAW-1/8-02-VDMA	Width 18 mm with lateral ports 2 and 4	2 / 1.3-58
9	Isolating disc	NSC-...	For creating pressure zones or for sealing ports on the end plates	2 / 1.3-65
10	Intermediate plate	NZV-01/02-VDMA	For connecting width 18 mm with width 26 mm	2 / 1.3-59
11	Manifold sub-base	NAW-1/4-01-VDMA	Width 26 mm with lateral ports 2 and 4	2 / 1.3-58
12	End plate	NEV-...	For sealing the manifold sub-bases width 26 mm	2 / 1.3-58

Solenoid valves VSVA, ISO 15407-1

System overview

Manifold assembly with vertical stacking

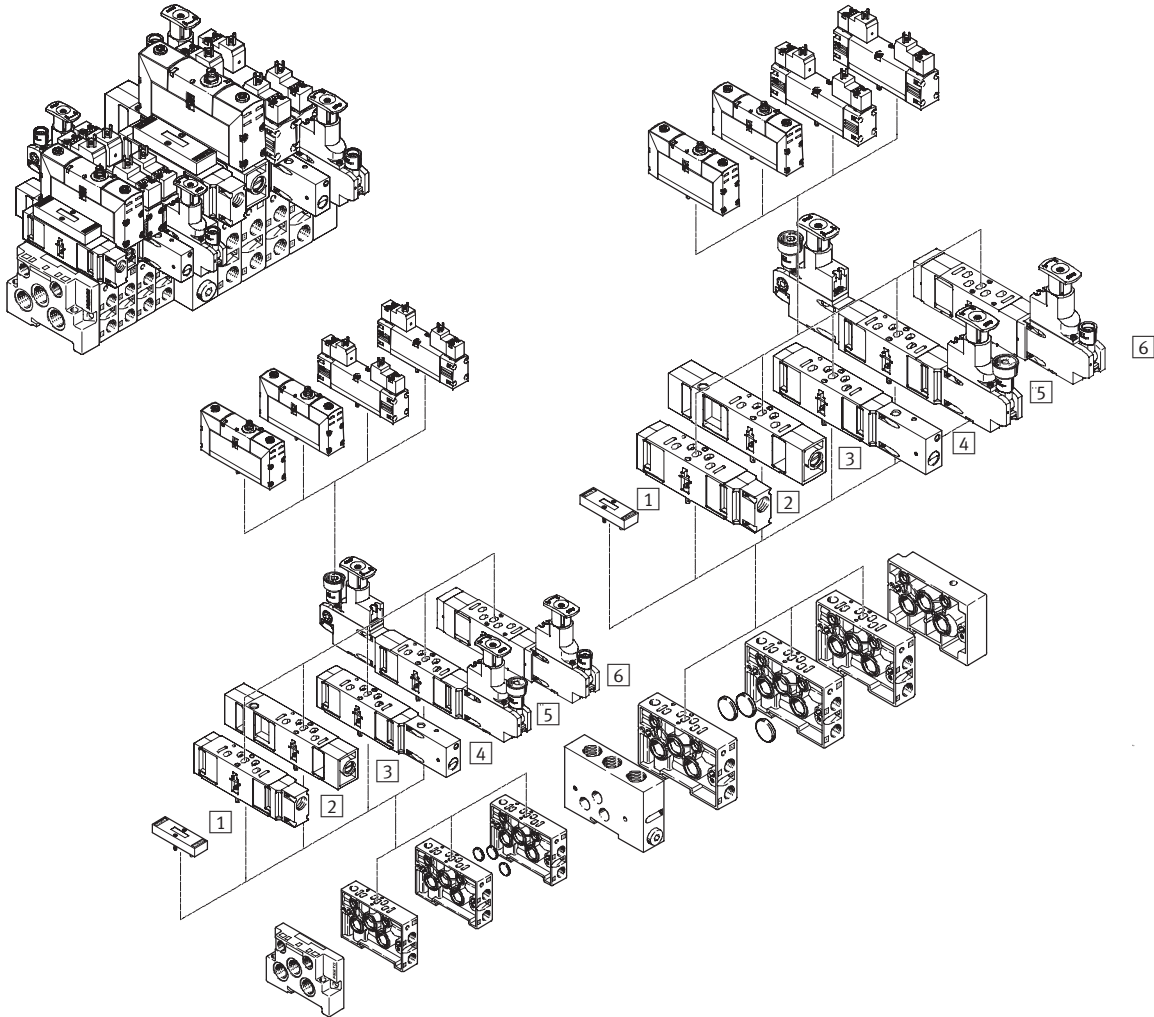

Component parts				
	Type	Brief description	→ Page	
1	Blanking plate	NDV-...	For vacant or spare position	2 / 1.3-65
2	Vertical supply plate	VABF...P1-A3...	For intermediate air supply	2 / 1.3-49
3	Flow control plate	VABF...F1-B1...	For flow control in ducts 3 and 5	2 / 1.3-48
4	Vertical shut-off plate	VABF...L1-D1...	With switch for manual shut-off of duct 1	2 / 1.3-50
5	Pressure regulator plate	VABF...R...-C2...	With two pressure regulators for working ports 2 and 4	2 / 1.3-46
6	Pressure regulator plate	VABF...R...-C2...	With one pressure regulator for working ports 2 or 4 or for duct 1	2 / 1.3-46

Solenoid valves VSVA, ISO 15407-1

Peripherals overview

Manifold assembly, valves with square plug

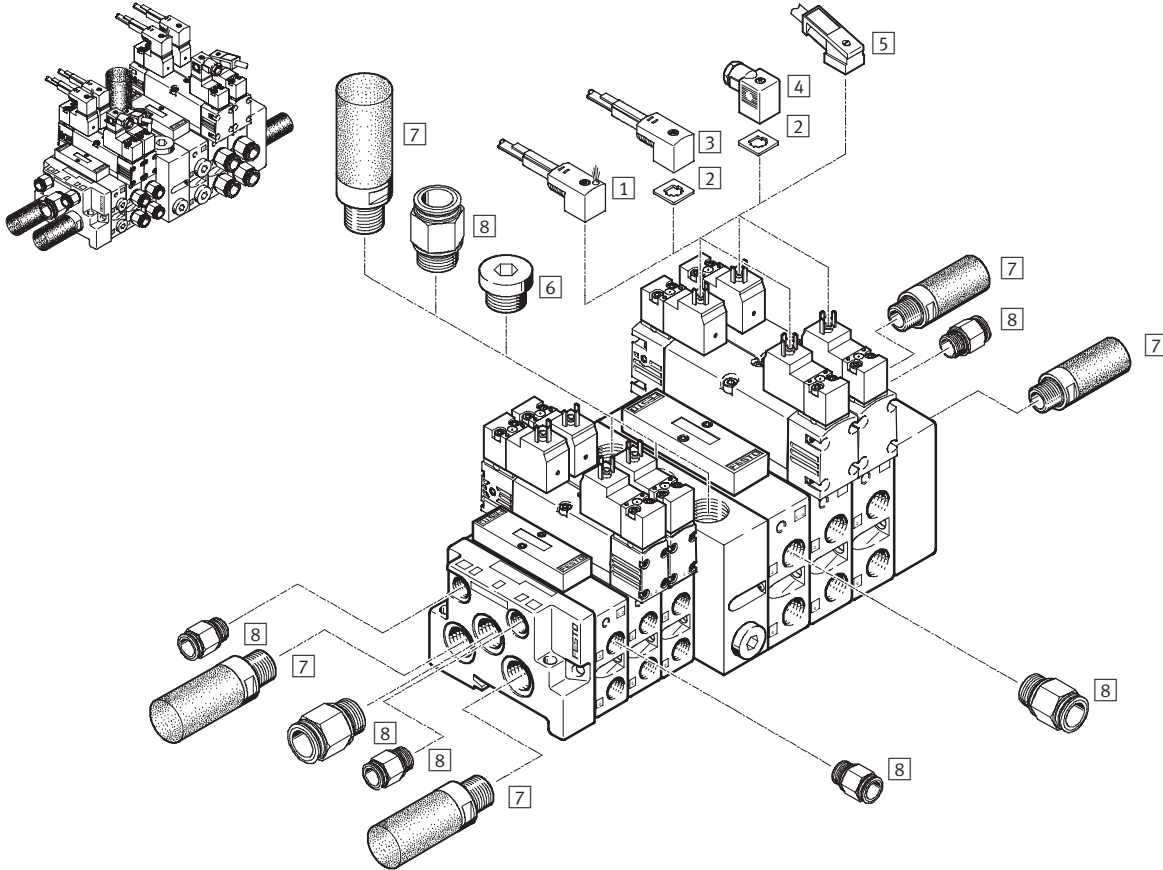

Component parts			
	Type	Brief description	→ Page
1	KMEB1-...-LED	With PVC casing and LED	2 / 1.3-77
2	MEB-LD	For indicating the signal status	2 / 1.3-78
3	KMEB1-...	With PVC casing	2 / 1.3-77
4	MSSD-EB	-	2 / 1.3-77
5	KMEB2-...-LED	With polyurethane casing and LED	2 / 1.3-77
6	B-...	For sealing unused ports	2 / 1.3-77
7	U-...	For fitting in exhaust ports	→ Volume 3
8	QS-...	For standard O.D. tubing	→ Volume 3

Solenoid valves VSVA, ISO 15407-1

Peripherals overview

Manifold assembly, valves with central plug

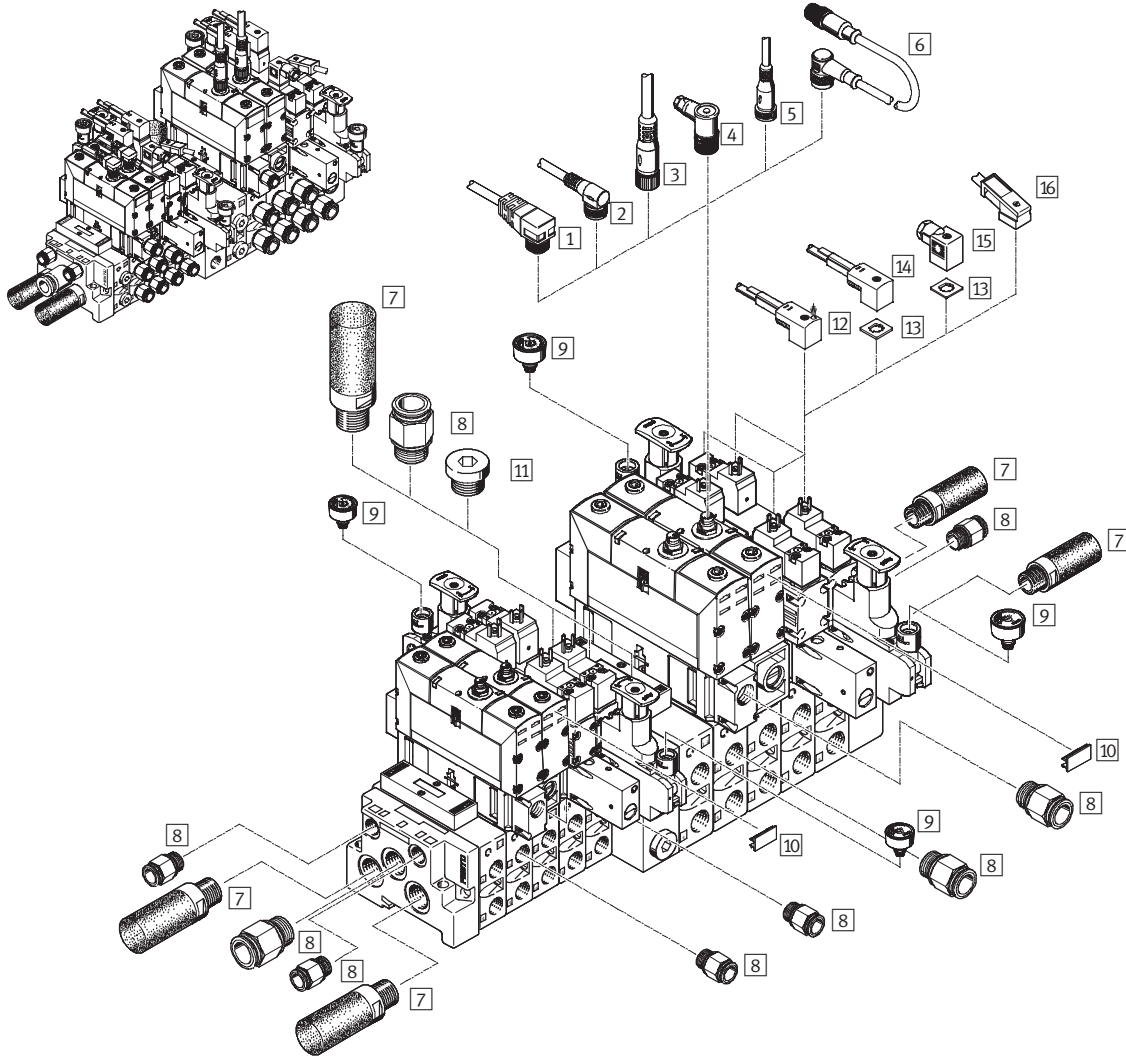

Component parts		Type	Brief description	→ Page
1	Plug socket with cable	SIM-M12-4-WD...	Angled plug socket	2 / 1.3-78
2	Plug socket with cable	SIM-M8-4-WD...	Angled plug socket	2 / 1.3-78
3	Plug socket with cable	SIM-M12-4-GD...	Straight plug socket	2 / 1.3-78
4	Plug socket	SEA-M12-4WD...	Angled	2 / 1.3-78
5	Plug socket with cable	SIM-M8-4-GD...	Straight plug socket	2 / 1.3-78
6	Connecting cable	KM-12-M12-...	Angled socket, straight plug	2 / 1.3-78
7	Silencer	U-...	For fitting in exhaust ports	→ Volume 3
8	Push-in fitting	QS-...	For standard O.D. tubing	→ Volume 3
9	Pressure gauge	PAGN-26-10-P10	Can be connected to the pressure regulator plate	2 / 1.3-77
10	Inscription labels	IBS-9x20	For identifying the VSVA valves with round plug	2 / 1.3-77
11	Blanking plugs	B-...	For sealing unused ports	2 / 1.3-77
12	Plug socket with cable	KMEB1-...-LED	With PVC casing and LED	2 / 1.3-77
13	Illuminating seal	MEB-LD-...	For indicating the signal status	2 / 1.3-78
14	Plug socket with cable	KMEB1-...	With PVC casing	2 / 1.3-77
15	Plug socket	MSSD-EB	-	2 / 1.3-77
16	Plug socket with cable	KMEB2-...-LED	With polyurethane casing and LED	2 / 1.3-77

Solenoid valves VSVA, ISO 15407-1/plug type C

Technical data – Directional control valves width 18 mm

 Flow rate
600 ... 750 l/min

 Voltage
12, 24 V DC
24, 110, 230 V AC

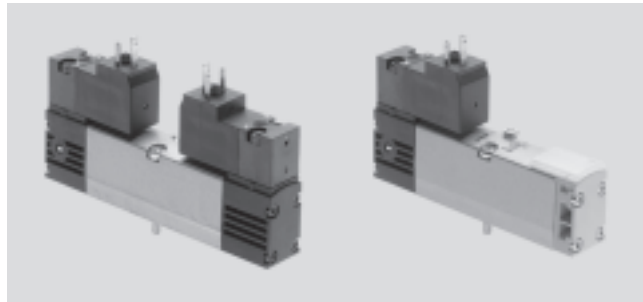

General technical data								
Valve function	2x 3/2			5/2		5/3		
Normal position	C ¹⁾ , N ⁵⁾	U ²⁾ , F ⁶⁾	H ⁴⁾ , W ⁷⁾	–	–	C ¹⁾	U ²⁾	E ³⁾
Memory stability	Monostable				Bi-stable		Monostable	
Pneumatic spring reset method	Yes			Yes	–	No		
Mechanical spring reset method	No			Yes	–	Yes		
Design	Piston spool valve							
Sealing principle	Soft							
Actuation type	Solenoid							
Pilot control mode	Piloted							
Pilot interface	To ISO 15218							
Pilot air supply	Internal or external							
Direction of flow	Non-reversible			Reversible for external pilot air supply				
Exhaust function	Flow control							
Manual override	Pushing (non-detenting)							
Type of mounting	On sub-base							
Mounting position	Any							
Nominal diameter	[mm]	5						
Flow rate of valve	[l/min]	600		750		650		
Flow rate of valve on individual sub-base	[l/min]	450		550		500		
Flow rate of valve, pneumatically interlinked	[l/min]	400		550		450		
Standard nominal flow rate	[l/min]	400		550		450		
Switching time on/off, pneumatic spring	[ms]	13/21		21/19		–		–
Switching time on/off, mechanical spring	[ms]	–		17/35		–		18/30
Switching time on/off, for N, F and W	[ms]	21/13		–		–		–
Changeover time	[ms]	–		–		15		–
Freedom from overlap	Yes							
Width	[mm]	18						
Ports on the sub-base	1, 2, 3, 4, 5	G ¹ / ₈						
	12, 14	M5						
Tightening torque, valve mounting	[Nm]	0.68 ... 0.92						
Product weight	[g]	174		127		174		
Noise level	[dB (A)]	85						
Conforms to	ISO 15407-1 and interface for pilot valve ISO 15218							
Corrosion resistance class	CRC	2 ⁸⁾						

1) C=Normally closed
 2) U=Normally open
 3) E=Normally exhausted
 4) H=2x 3/2-way valve in one housing with 1x normally closed and 1x normally open
 5) N=Normally closed, reverse operation, i.e. the pressure supply ports are 3 and 5, venting is via port 1
 6) F=Normally open, reverse operation, i.e. the pressure supply ports are 3 and 5, venting is via port 1
 7) W=2x 3/2-way valve in one housing with 1x normally closed and 1x normally open, reverse operation, i.e. the pressure supply ports are 3 and 5, venting is via port 1
 8) Corrosion resistance class 2 to Festo standard 940 070
 Components subject to moderate corrosion stress. Externally visible parts with primarily decorative surface requirements which are in direct contact with a normal industrial environment or media such as coolants or lubricating agents.

Solenoid valves VSVA, ISO 15407-1/plug type C

Technical data – Directional control valves width 18 mm

Operating and environmental conditions				
Valve function		2x 3/2	5/2	5/3
Operating medium		Filtered compressed air, grade of filtration 40µm, lubricated or unlubricated		
Operating pressure	Internal pilot air supply [bar]	2 ... 10	2 ... 10, 3 ... 10 with mechanical spring	3 ... 10
	External pilot air supply [bar]	2 ... 10	-0.9 ... 10	
Pilot pressure with pneumatic spring [bar]		2 ... 10 ¹⁾	2 ... 10	-
Pilot pressure with mechanical spring [bar]		-	3 ... 10	3 ... 10
Ambient temperature [°C]		-5 ... +50		
Temperature of medium [°C]		-5 ... +50		
Fire protection classification to UL94		HB		

1) Pilot pressure dependent on operating pressure → Graph

Minimum pilot pressure p₁₂, p₁₄ as a function of the operating pressure p₁ (external pilot air supply)

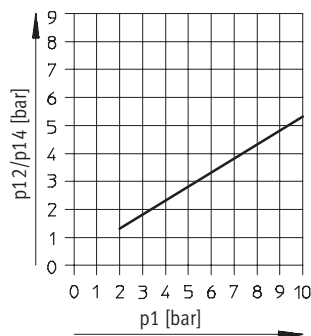

Electrical data			
Electrical connection		Plug, square design to DIN EN 175301-803, type C	
		12 V/24 V DC/AC without protective earth conductor	110 V/230 V AC with protective earth conductor
Operating voltage	DC voltage [V DC]	12, 24 +10%/-15%	
	AC voltage [V AC]	24, 110, 230 +10%/-15%	
Coil characteristics	DC voltage [W]	1.8	
	AC voltage [VA]	2.1 at 110 V/230 V, 2.3 at 24 V	
Duty cycle [%]		100	
Protection class to EN 60529		IP65 (in combination with plug socket)	
CE mark		73/23/EEC (low voltage)	

Solenoid valves VSVA, ISO 15407-1/plug type C

Technical data – Directional control valves width 18 mm

Materials

Sectional view

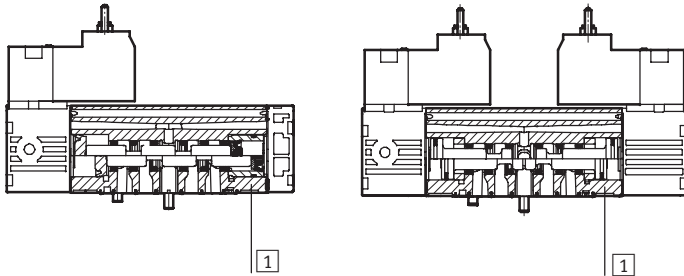

1	Housing	Die-cast aluminium
-	Seals	Nitrile rubber
-	Screws	Galvanised steel
-	Note on materials	Contains PWIS (paint wetting impairment substances)

Dimensions

Download CAD data → www.festo.com/en/engineering

5/2-way valve, single solenoid

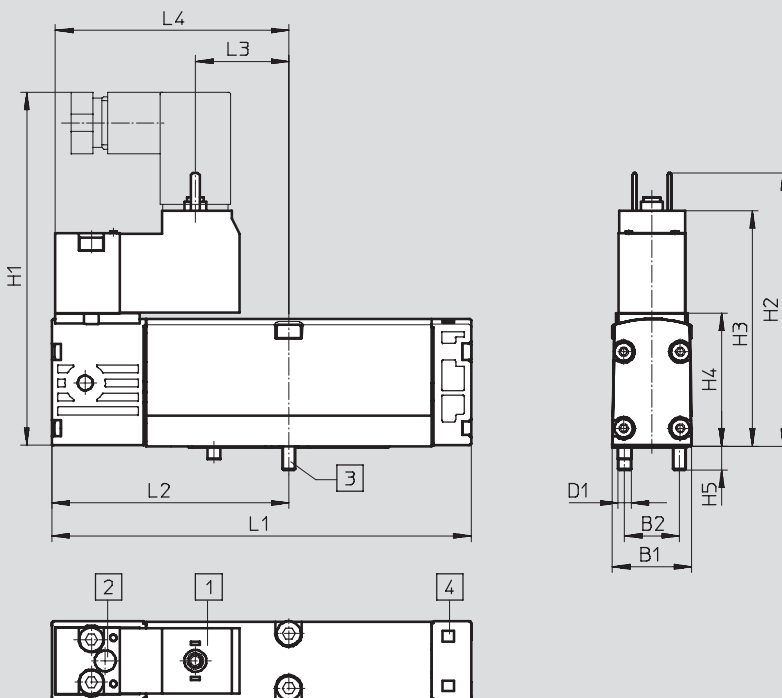

- 1 Connection dimensions and device plug to DIN EN 175301-803, type C
- 2 Manual override
- 3 Captive screws
- 4 Slot for inscription label

	B1	B2	D1	H1	H2	H3	H4	H5	L1	L2	L3	L4	L5
VSVA-B-M52...	18	12,5	M3	80,6	62,2	53,6	30,3	5,4	95,4	53,9	21,25	53,1	102,2

Solenoid valves VSVA, ISO 15407-1/plug type C

Technical data – Directional control valves width 18 mm



Dimensions Download CAD data → www.festo.com/en/engineering

2x 3/2-way valve, 5/2-way valve, double solenoid, 5/3-way valve

1 Connection dimensions and device plug to DIN EN 175301-803, type C 2 Manual override 4 Slot for inscription label
 3 Captive screws

	B1	B2	D1	H1	H2	H3	H4	H5	L1	L2	L3	L4	L5
VSVA-B-M52...	18	12,5	M3	80,6	62,2	53,6	30,3	5,4	107,8	53,9	21,25	53,1	102,2

Dimensions Download CAD data → www.festo.com/en/engineering

5/2-way valve, single solenoid – Pilot valve for widths 18 mm and 26 mm

1 Connection dimensions and device plug to DIN EN 175301-803, type C 2 Manual override 4 Slot for inscription label
 3 Captive screws 5 Pneumatic port pattern to ISO 15218

	B1	B2	D1	H4	H5	L1	L2
VSVA-B-M52...	18	12,5	M3	30,3	5,4	95,4	53,9

Standard directional control valves
ISO 15407-1
1.3

Solenoid valves VSVA, ISO 15407-1/plug type C

Technical data – Directional control valves width 18 mm

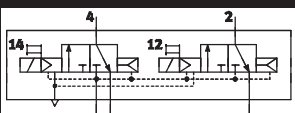
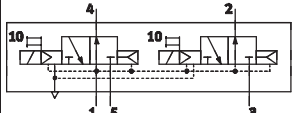
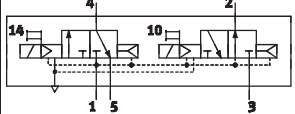
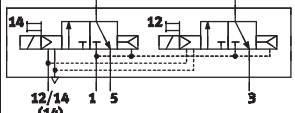
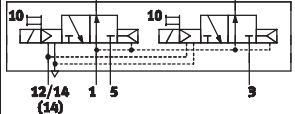
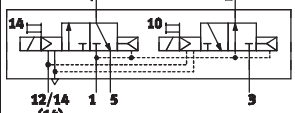
Ordering data – 2x 3/2-way valve ¹⁾							
Code	Circuit symbol	Normal position	Pilot air supply	Voltage		Part No.	Type
				V DC	V AC		
K		2x closed	Internal	24	–	546 693	VSVA-B-T32C-AH-A2-1C1
				12	–	547 129	VSVA-B-T32C-AH-A2-5C1
				–	230	547 209	VSVA-B-T32C-AH-A2-3AC1
				–	110	547 169	VSVA-B-T32C-AH-A2-2AC1
				–	24	547 089	VSVA-B-T32C-AH-A2-1AC1
N		2x open	Internal	24	–	546 695	VSVA-B-T32U-AH-A2-1C1
				12	–	547 131	VSVA-B-T32U-AH-A2-5C1
				–	230	547 211	VSVA-B-T32U-AH-A2-3AC1
				–	110	547 171	VSVA-B-T32U-AH-A2-2AC1
				–	24	547 091	VSVA-B-T32U-AH-A2-1AC1
H		1x closed 1x open	Internal	24	–	547 067	VSVA-B-T32H-AH-A2-1C1
				12	–	547 133	VSVA-B-T32H-AH-A2-5C1
				–	230	547 213	VSVA-B-T32H-AH-A2-3AC1
				–	110	547 173	VSVA-B-T32H-AH-A2-2AC1
				–	24	547 093	VSVA-B-T32H-AH-A2-1AC1
K		2x closed	External	24	–	547 069	VSVA-B-T32C-AZH-A2-1C1
				12	–	547 149	VSVA-B-T32C-AZH-A2-5C1
				–	230	547 229	VSVA-B-T32C-AZH-A2-3AC1
				–	110	547 189	VSVA-B-T32C-AZH-A2-2AC1
				–	24	547 109	VSVA-B-T32C-AZH-A2-1AC1
N		2x open	External	24	–	547 071	VSVA-B-T32U-AZH-A2-1C1
				12	–	547 151	VSVA-B-T32U-AZH-A2-5C1
				–	230	547 231	VSVA-B-T32U-AZH-A2-3AC1
				–	110	547 191	VSVA-B-T32U-AZH-A2-2AC1
				–	24	547 111	VSVA-B-T32U-AZH-A2-1AC1
H		1x closed 1x open	External	24	–	547 073	VSVA-B-T32H-AZH-A2-1C1
				12	–	547 153	VSVA-B-T32H-AZH-A2-5C1
				–	230	547 233	VSVA-B-T32H-AZH-A2-3AC1
				–	110	547 193	VSVA-B-T32H-AZH-A2-2AC1
				–	24	547 113	VSVA-B-T32H-AZH-A2-1AC1

1) 2x 3/2-way valves for reverse operation on request

Solenoid valves VSVA, ISO 15407-1/plug type C

Technical data – Directional control valves width 18 mm

FESTO

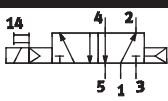
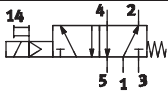
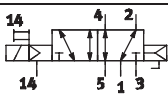
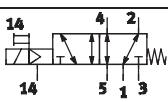
Ordering data – 5/2-way valve, single solenoid (monostable)						
Code	Circuit symbol	Reset method	Pilot air supply	Voltage		Part No. Type
				V DC	V AC	
M		Pneumatic	Internal	24	–	546 701 VSVA-B-M52-AH-A2-1C1
				12	–	547 139 VSVA-B-M52-AH-A2-5C1
				–	230	547 219 VSVA-B-M52-AH-A2-3AC1
				–	110	547 179 VSVA-B-M52-AH-A2-2AC1
				–	24	547 099 VSVA-B-M52-AH-A2-1AC1
O		Mechanical spring	Internal	24	–	546 703 VSVA-B-M52-MH-A2-1C1
				12	–	547 141 VSVA-B-M52-MH-A2-5C1
				–	230	547 221 VSVA-B-M52-MH-A2-3AC1
				–	110	547 181 VSVA-B-M52-MH-A2-2AC1
				–	24	547 101 VSVA-B-M52-MH-A2-1AC1
M		Pneumatic	External	24	–	547 079 VSVA-B-M52-AZH-A2-1C1
				12	–	547 159 VSVA-B-M52-AZH-A2-5C1
				–	230	547 239 VSVA-B-M52-AZH-A2-3AC1
				–	110	547 199 VSVA-B-M52-AZH-A2-2AC1
				–	24	547 119 VSVA-B-M52-AZH-A2-1AC1
O		Mechanical spring	External	24	–	547 081 VSVA-B-M52-MZH-A2-1C1
				12	–	547 161 VSVA-B-M52-MZH-A2-5C1
				–	230	547 241 VSVA-B-M52-MZH-A2-3AC1
				–	110	547 201 VSVA-B-M52-MZH-A2-2AC1
				–	24	547 121 VSVA-B-M52-MZH-A2-1AC1

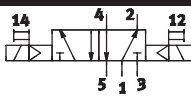
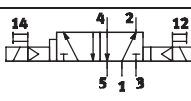
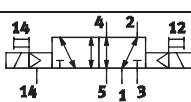
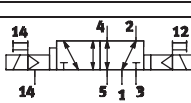
Ordering data – 5/2-way valve, double solenoid (bi-stable)						
Code	Circuit symbol	Dominant	Pilot air supply	Voltage		Part No. Type
				V DC	V AC	
J		1st signal	Internal	24	–	546 697 VSVA-B-B52-H-A2-1C1
				12	–	547 135 VSVA-B-B52-H-A2-5C1
				–	230	547 215 VSVA-B-B52-H-A2-3AC1
				–	110	547 175 VSVA-B-B52-H-A2-2AC1
				–	24	547 095 VSVA-B-B52-H-A2-1AC1
D		At 14	Internal	24	–	546 699 VSVA-B-D52-H-A2-1C1
				12	–	547 137 VSVA-B-D52-H-A2-5C1
				–	230	547 217 VSVA-B-D52-H-A2-3AC1
				–	110	547 177 VSVA-B-D52-H-A2-2AC1
				–	24	547 097 VSVA-B-D52-H-A2-1AC1
J		1st signal	External	24	–	547 075 VSVA-B-B52-ZH-A2-1C1
				12	–	547 155 VSVA-B-B52-ZH-A2-5C1
				–	230	547 235 VSVA-B-B52-ZH-A2-3AC1
				–	110	547 195 VSVA-B-B52-ZH-A2-2AC1
				–	24	547 115 VSVA-B-B52-ZH-A2-1AC1
D		At 14	External	24	–	547 077 VSVA-B-D52-ZH-A2-1C1
				12	–	547 157 VSVA-B-D52-ZH-A2-5C1
				–	230	547 237 VSVA-B-D52-ZH-A2-3AC1
				–	110	547 197 VSVA-B-D52-ZH-A2-2AC1
				–	24	547 117 VSVA-B-D52-ZH-A2-1AC1

Solenoid valves VSVA, ISO 15407-1/plug type C

Technical data – Directional control valves width 18 mm

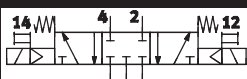
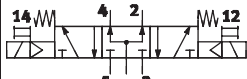
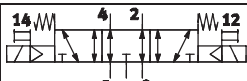
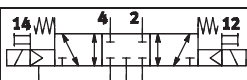
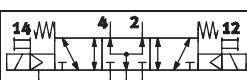
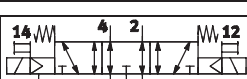
Ordering data – 5/3-way valve, double solenoid (monostable)							
Code	Circuit symbol	Normal position	Pilot air supply	Voltage		Part No.	Type
				V DC	V AC		
G		Closed	Internal	24	–	546 709	VSVA-B-P53C-H-A2-1C1
				12	–	547 147	VSVA-B-P53C-H-A2-5C1
				–	230	547 227	VSVA-B-P53C-H-A2-3AC1
				–	110	547 187	VSVA-B-P53C-H-A2-2AC1
				–	24	547 107	VSVA-B-P53C-H-A2-1AC1
B		Open	Internal	24	–	546 705	VSVA-B-P53U-H-A2-1C1
				12	–	547 143	VSVA-B-P53U-H-A2-5C1
				–	230	547 223	VSVA-B-P53U-H-A2-3AC1
				–	110	547 183	VSVA-B-P53U-H-A2-2AC1
				–	24	547 103	VSVA-B-P53U-H-A2-1AC1
E		Exhausted	Internal	24	–	546 707	VSVA-B-P53E-H-A2-1C1
				12	–	547 145	VSVA-B-P53E-H-A2-5C1
				–	230	547 225	VSVA-B-P53E-H-A2-3AC1
				–	110	547 185	VSVA-B-P53E-H-A2-2AC1
				–	24	547 105	VSVA-B-P53E-H-A2-1AC1
G		Closed	External	24	–	547 087	VSVA-B-P53C-ZH-A2-1C1
				12	–	547 167	VSVA-B-P53C-ZH-A2-5C1
				–	230	547 247	VSVA-B-P53C-ZH-A2-3AC1
				–	110	547 207	VSVA-B-P53C-ZH-A2-2AC1
				–	24	547 127	VSVA-B-P53C-ZH-A2-1AC1
B		Open	External	24	–	547 083	VSVA-B-P53U-ZH-A2-1C1
				12	–	547 163	VSVA-B-P53U-ZH-A2-5C1
				–	230	547 243	VSVA-B-P53U-ZH-A2-3AC1
				–	110	547 203	VSVA-B-P53U-ZH-A2-2AC1
				–	24	547 123	VSVA-B-P53U-ZH-A2-1AC1
E		Exhausted	External	24	–	547 085	VSVA-B-P53E-ZH-A2-1C1
				12	–	547 165	VSVA-B-P53E-ZH-A2-5C1
				–	230	547 245	VSVA-B-P53E-ZH-A2-3AC1
				–	110	547 205	VSVA-B-P53E-ZH-A2-2AC1
				–	24	547 125	VSVA-B-P53E-ZH-A2-1AC1

Solenoid valves VSVA, ISO 15407-1/plug type C



Technical data – Directional control valves width 18 mm without pilot valve

Ordering data – 2x 3/2-way valve without pilot valve					
Constructional design	Normal position	Pilot air supply	Part No.	Type	
	2x closed	Internal	546 732	VSVA-B-T32C-A-A2-P1	
	2x open	Internal	546 734	VSVA-B-T32U-A-A2-P1	

Ordering data – 5/2-way valve, single solenoid (monostable) without pilot valve					
Constructional design	Reset method	Pilot air supply	Part No.	Type	
	Pneumatic	Internal	546 740	VSVA-B-M52-A-A2-P1	
	Mechanical spring	Internal	546 742	VSVA-B-M52-M-A2-P1	



Ordering data – 5/2-way double solenoid (bi-stable) valve without pilot valve					
Constructional design	Dominant	Pilot air supply	Part No.	Type	
	1st signal	Internal	546 736	VSVA-B-B52-A2-P1	
	At 14	Internal	546 738	VSVA-B-D52-A2-P1	

Ordering data – 5/3-way double solenoid mid-position valve (monostable) without pilot valve					
Constructional design	Normal position	Pilot air supply	Part No.	Type	
	Closed	Internal	546 748	VSVA-B-P53C-A2-P1	
	Open	Internal	546 744	VSVA-B-P53U-A2-P1	
	Exhausted	Internal	546 746	VSVA-B-P53E-A2-P1	

Ordering data – Pilot valve to ISO 15218								
Constructional design	Plug, square design	Protective earth conductor	Output		Voltage		Part No.	Type
			[W]	[VA]	V DC	V AC		
	DIN EN 175301-803, type C	No	1,8	–	24	–	546 256	VS-CS-B-M32-MH-WA-1C1
		No	1,8	–	12	–	546 257	VS-CS-B-M32-MH-WA-5C1
	DIN EN 175301-803, type C	Yes	–	2,1	–	230	546 260	VS-CS-B-M32-MH-WA-3AC1
		Yes	–	2,1	–	110	546 259	VS-CS-B-M32-MH-WA-2AC1
		No	–	2,3	–	24	546 258	VS-CS-B-M32-MH-WA-1AC1

Solenoid valves VSVA, ISO 15407-1/plug type C

Technical data – Directional control valves width 26 mm

-  Flow rate
1,250 ... 1,400 l/min
-  Voltage
12, 24 V DC
24, 110, 230 V AC

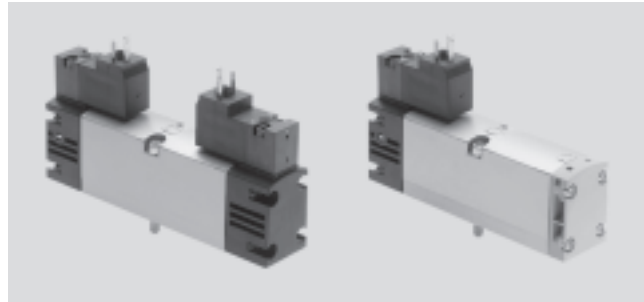

General technical data							
Valve function	2x 3/2			5/2		5/3	
Normal position	C ¹⁾ , N ⁵⁾	U ²⁾ , F ⁶⁾	H ⁴⁾ , W ⁷⁾	–	–	C ¹⁾	U ²⁾ , E ³⁾
Memory stability	Monostable				Bi-stable	Monostable	
Pneumatic spring reset method	Yes			Yes	–	No	
Mechanical spring reset method	No			Yes	–	Yes	
Design	Piston spool valve						
Sealing principle	Soft						
Actuation type	Electric						
Pilot control mode	Piloted						
Pilot interface	To ISO 15218						
Pilot air supply	Internal or external						
Direction of flow	Non-reversible			Reversible for external pilot air supply			
Exhaust function	Flow control						
Manual override	Pushing (non-detenting)						
Type of mounting	On sub-base						
Mounting position	Any						
Nominal diameter	[mm]	9					
Flow rate of valve	[l/min]	1,250	1,400	1,400			
Flow rate of valve on individual sub-base	[l/min]	1,000	1,100	1,100			
Flow rate of valve, pneumatically interlinked	[l/min]	900	1,100	1,000			
Standard nominal flow rate	[l/min]	900	1,100	1,000			
Switching time on/off, pneumatic spring	[ms]	20/28	35/43	–	–		
Switching time on/off, mechanical spring	[ms]	–	26/56	–	23/58		
Switching time on/off, for N, F and W	[ms]	28/20	–	–	–		
Changeover time	[ms]	–	–	18	–		
Freedom from overlap	Yes						
Width	[mm]	26					
Ports on the sub-base	1, 2, 3, 4, 5	G $\frac{1}{4}$					
	12, 14	M5					
Tightening torque, valve mounting	[Nm]	1.62 ... 2.18					
Product weight	[g]	305	260	305			
Noise level	[dB (A)]	85					
Conforms to	ISO 15407-1 and interface for pilot valve ISO 15218						
Corrosion resistance class	CRC	2 ⁸⁾					

1) C=Normally closed
 2) U=Normally open
 3) E=Normally exhausted
 4) H=2x 3/2-way valve in one housing with 1x normally closed and 1x normally open
 5) N=Normally closed, reverse operation, i.e. the pressure supply ports are 3 and 5, venting is via port 1
 6) F=Normally open, reverse operation, i.e. the pressure supply ports are 3 and 5, venting is via port 1
 7) W=2x 3/2-way valve in one housing with 1x normally closed and 1x normally open, reverse operation, i.e. the pressure supply ports are 3 and 5, venting is via port 1
 8) Corrosion resistance class 2 to Festo standard 940 070
 Components subject to moderate corrosion stress. Externally visible parts with primarily decorative surface requirements which are in direct contact with a normal industrial environment or media such as coolants or lubricating agents.

Solenoid valves VSVA, ISO 15407-1/plug type C

Technical data – Directional control valves width 26 mm

Operating and environmental conditions				
Valve function		2x 3/2	5/2	5/3
Operating medium		Filtered compressed air, grade of filtration 40µm, lubricated or unlubricated, vacuum		
Operating pressure	Internal pilot air supply [bar]	2 ... 10	2 ... 10, 3 ... 10 with mechanical spring	3 ... 10
	External pilot air supply [bar]	2... 10	-0.9 ... 10	
Pilot pressure with pneumatic spring [bar]		2 ... 10 ¹⁾	2 ... 10	-
Pilot pressure with mechanical spring [bar]		-	3 ... 10	3 ... 10
Ambient temperature [°C]		-5 ... +50		
Temperature of medium [°C]		-5 ... +50		
Fire protection classification to UL94		HB		

1) Pilot pressure dependent on operating pressure → Graph

Minimum pilot pressure p₁₂, p₁₄ as a function of the operating pressure p₁ (external pilot air supply)

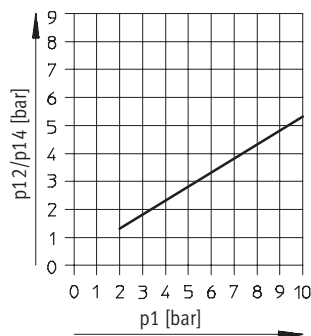

Electrical data			
Electrical connection		Plug, square design to DIN EN 175301-803, type C	
		12 V/24 V DC/AC without protective earth conductor	110 V/230 V AC with protective earth conductor
Operating voltage	DC voltage [V DC]	12, 24 +10%/-15%	
	AC voltage [V AC]	24, 110, 230 +10%/-15%	
Coil characteristics	DC voltage [W]	1.8	
	AC voltage [VA]	2.1 at 110 V/230 V, 2.3 at 24 V	
Duty cycle [%]		100	
Protection class to EN 60529		IP65 (in combination with plug socket)	
CE mark		73/23/EEC (low voltage)	

Solenoid valves VSVA, ISO 15407-1/plug type C

Technical data – Directional control valves 26

Materials

Sectional view

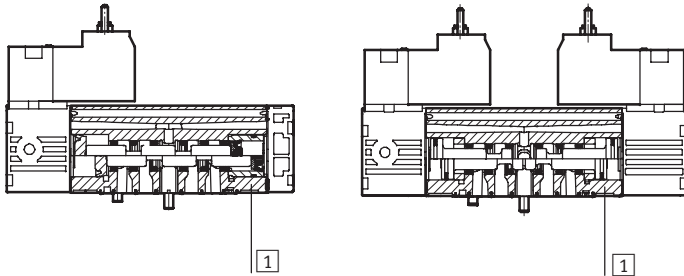

1	Housing	Die-cast aluminium
-	Seals	Nitrile rubber
-	Screws	Galvanised steel
-	Note on materials	Contains PWIS (paint wetting impairment substances)

Dimensions

Download CAD data → www.festo.com/en/engineering

5/2-way valve, single solenoid

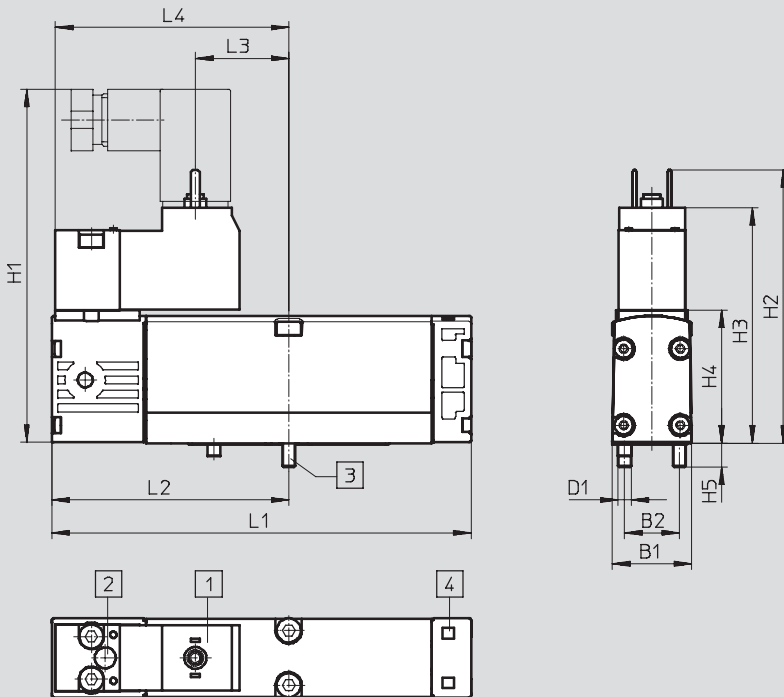

- 1 Connection dimensions and device plug to DIN EN 175301-803, type C
- 2 Manual override
- 3 Captive screws
- 4 Slot for inscription label

	B1	B2	D1	H1	H2	H3	H4	H5	L1	L2	L3	L4	L5
VSVA-B-M52...	26.3	19	M4	89.2	71.2	62.6	39.3	7	113.1	63.1	29.75	61.6	123.2

Solenoid valves VSVA, ISO 15407-1/plug type C

Technical data – Directional control valves 26



Dimensions Download CAD data → www.festo.com/en/engineering

2x 3/2-way valve, 5/2-way valve, double solenoid, 5/3-way valve

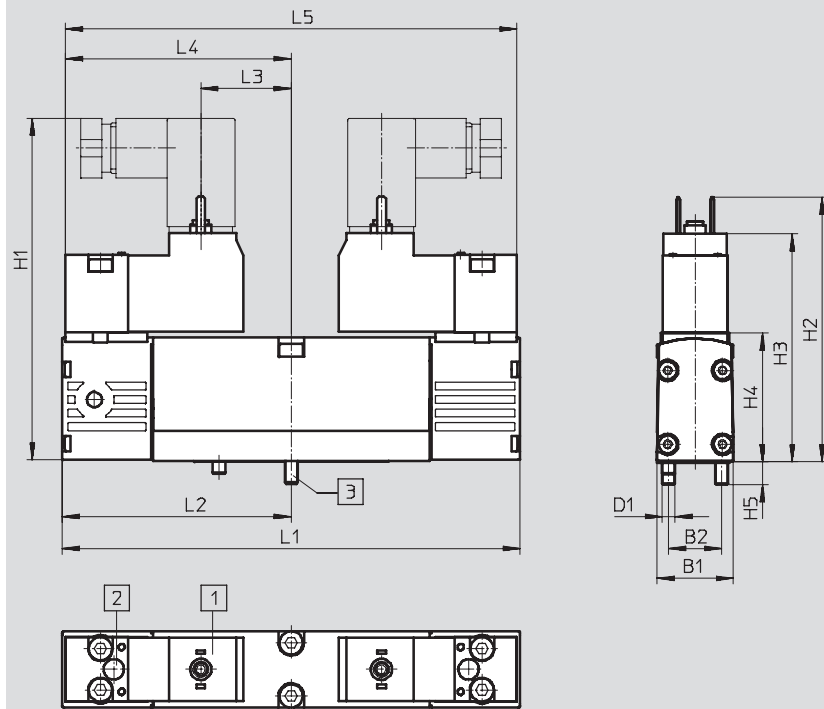

- 1 Connection dimensions and device plug to DIN EN 175301-803, type C
- 2 Manual override
- 3 Captive screws
- 4 Slot for inscription label

	B1	B2	D1	H1	H2	H3	H4	H5	L1	L2	L3	L4	L5
VSVA-B-M52...	26.3	19	M4	89.2	71.2	62.2	39.3	7	126.2	63.1	29.75	61.6	123.2

Dimensions Download CAD data → www.festo.com/en/engineering

5/2-way valve, single solenoid – Pilot valve for widths 18 mm and 26 mm

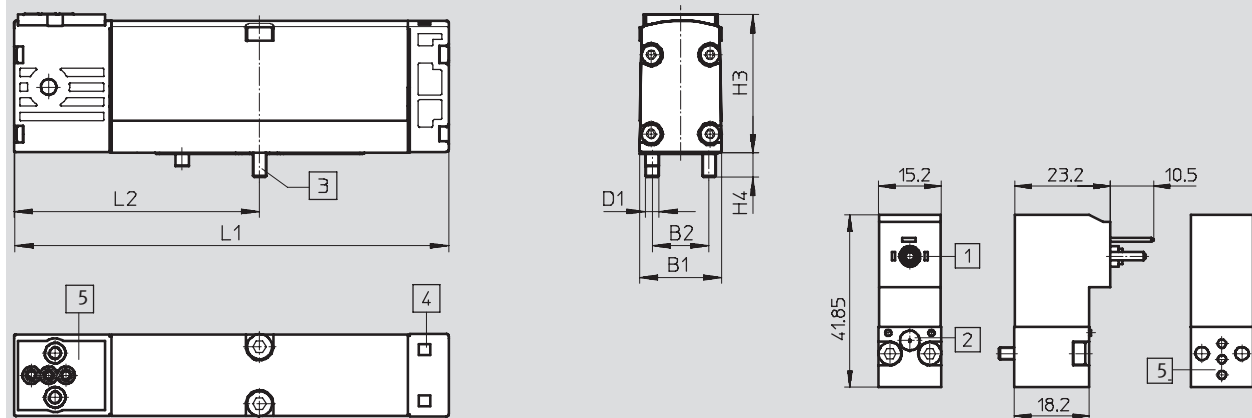

- 1 Connection dimensions and device plug to DIN EN 175301-803, type C
- 2 Manual override
- 3 Captive screws
- 4 Slot for inscription label
- 5 Pneumatic port pattern to ISO 15218

	B1	B2	D1	H4	H5	L1	L2
VSVA-B-M52...	26.3	19	M4	39.3	7	113.1	63.1

Solenoid valves VSVA, ISO 15407-1/plug type C

Technical data – Directional control valves width 26 mm

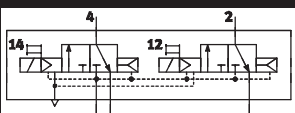
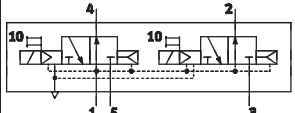
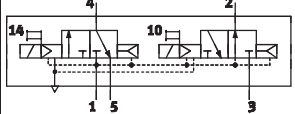
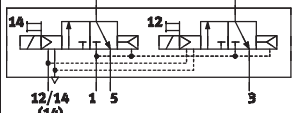
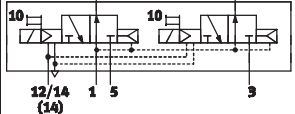
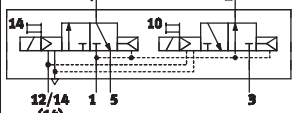
Ordering data – 2x 3/2-way valve ¹⁾							
Code	Circuit symbol	Normal position	Pilot air supply	Voltage		Part No.	Type
				V DC	V AC		
K		2x closed	Internal	24	–	546 692	VSVA-B-T32C-AH-A1-1C1
				12	–	547 128	VSVA-B-T32C-AH-A1-5C1
				–	230	547 208	VSVA-B-T32C-AH-A1-3AC1
				–	110	547 168	VSVA-B-T32C-AH-A1-2AC1
				–	24	547 088	VSVA-B-T32C-AH-A1-1AC1
N		2x open	Internal	24	–	546 694	VSVA-B-T32U-AH-A1-1C1
				12	–	547 130	VSVA-B-T32U-AH-A1-5C1
				–	230	547 210	VSVA-B-T32U-AH-A1-3AC1
				–	110	547 170	VSVA-B-T32U-AH-A1-2AC1
				–	24	547 090	VSVA-B-T32U-AH-A1-1AC1
H		1x closed 1x open	Internal	24	–	547 066	VSVA-B-T32H-AH-A1-1C1
				12	–	547 132	VSVA-B-T32H-AH-A1-5C1
				–	230	547 212	VSVA-B-T32H-AH-A1-3AC1
				–	110	547 172	VSVA-B-T32H-AH-A1-2AC1
				–	24	547 092	VSVA-B-T32H-AH-A1-1AC1
K		2x closed	External	24	–	547 068	VSVA-B-T32C-AZH-A1-1C1
				12	–	547 148	VSVA-B-T32C-AZH-A1-5C1
				–	230	547 228	VSVA-B-T32C-AZH-A1-3AC1
				–	110	547 188	VSVA-B-T32C-AZH-A1-2AC1
				–	24	547 108	VSVA-B-T32C-AZH-A1-1AC1
N		2x open	External	24	–	547 070	VSVA-B-T32U-AZH-A1-1C1
				12	–	547 150	VSVA-B-T32U-AZH-A1-5C1
				–	230	547 230	VSVA-B-T32U-AZH-A1-3AC1
				–	110	547 190	VSVA-B-T32U-AZH-A1-2AC1
				–	24	547 110	VSVA-B-T32U-AZH-A1-1AC1
H		1x closed 1x open	External	24	–	547 072	VSVA-B-T32H-AZH-A1-1C1
				12	–	547 152	VSVA-B-T32H-AZH-A1-5C1
				–	230	547 232	VSVA-B-T32H-AZH-A1-3AC1
				–	110	547 192	VSVA-B-T32H-AZH-A1-2AC1
				–	24	547 112	VSVA-B-T32H-AZH-A1-1AC1

1) 2x 3/2-way valves for reverse operation on request

Solenoid valves VSVA, ISO 15407-1/plug type C

Technical data – Directional control valves width 26 mm

FESTO

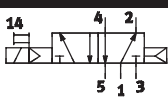
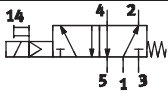
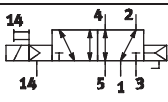
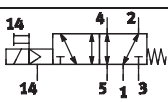
Ordering data – 5/2-way valve, single solenoid (monostable)						
Code	Circuit symbol	Reset method	Pilot air supply	Voltage		Part No. Type
				V DC	V AC	
M		Pneumatic	Internal	24	–	546 700 VSVA-B-M52-AH-A1-1C1
				12	–	547 138 VSVA-B-M52-AH-A1-5C1
				–	230	547 218 VSVA-B-M52-AH-A1-3AC1
				–	110	547 178 VSVA-B-M52-AH-A1-2AC1
				–	24	547 098 VSVA-B-M52-AH-A1-1AC1
O		Mechanical spring	Internal	24	–	546 702 VSVA-B-M52-MH-A1-1C1
				12	–	547 140 VSVA-B-M52-MH-A1-5C1
				–	230	547 220 VSVA-B-M52-MH-A1-3AC1
				–	110	547 180 VSVA-B-M52-MH-A1-2AC1
				–	24	547 100 VSVA-B-M52-MH-A1-1AC1
M		Pneumatic	External	24	–	547 078 VSVA-B-M52-AZH-A1-1C1
				12	–	547 158 VSVA-B-M52-AZH-A1-5C1
				–	230	547 238 VSVA-B-M52-AZH-A1-3AC1
				–	110	547 198 VSVA-B-M52-AZH-A1-2AC1
				–	24	547 118 VSVA-B-M52-AZH-A1-1AC1
O		Mechanical spring	External	24	–	547 080 VSVA-B-M52-MZH-A1-1C1
				12	–	547 160 VSVA-B-M52-MZH-A1-5C1
				–	230	547 240 VSVA-B-M52-MZH-A1-3AC1
				–	110	547 200 VSVA-B-M52-MZH-A1-2AC1
				–	24	547 120 VSVA-B-M52-MZH-A1-1AC1

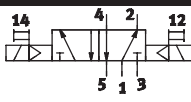
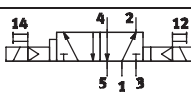
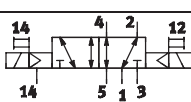
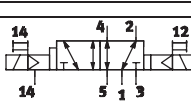
Ordering data – 5/2-way valve, double solenoid (bi-stable)						
Code	Circuit symbol	Dominance	Pilot air supply	Voltage		Part No. Type
				V DC	V AC	
J		1st signal	Internal	24	–	546 696 VSVA-B-B52-H-A1-1C1
				12	–	547 134 VSVA-B-B52-H-A1-5C1
				–	230	547 214 VSVA-B-B52-H-A1-3AC1
				–	110	547 174 VSVA-B-B52-H-A1-2AC1
				–	24	547 094 VSVA-B-B52-H-A1-1AC1
D		At 14	Internal	24	–	546 698 VSVA-B-D52-H-A1-1C1
				12	–	547 136 VSVA-B-D52-H-A1-5C1
				–	230	547 216 VSVA-B-D52-H-A1-3AC1
				–	110	547 176 VSVA-B-D52-H-A1-2AC1
				–	24	547 096 VSVA-B-D52-H-A1-1AC1
J		1st signal	External	24	–	547 074 VSVA-B-B52-ZH-A1-1C1
				12	–	547 154 VSVA-B-B52-ZH-A1-5C1
				–	230	547 234 VSVA-B-B52-ZH-A1-3AC1
				–	110	547 194 VSVA-B-B52-ZH-A1-2AC1
				–	24	547 114 VSVA-B-B52-ZH-A1-1AC1
D		At 14	External	24	–	547 076 VSVA-B-D52-ZH-A1-1C1
				12	–	547 156 VSVA-B-D52-ZH-A1-5C1
				–	230	547 236 VSVA-B-D52-ZH-A1-3AC1
				–	110	547 196 VSVA-B-D52-ZH-A1-2AC1
				–	24	547 116 VSVA-B-D52-ZH-A1-1AC1

Solenoid valves VSVA, ISO 15407-1/plug type C

Technical data – Directional control valves width 26 mm

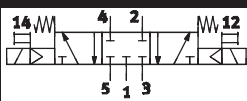
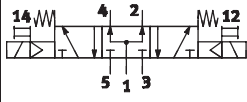
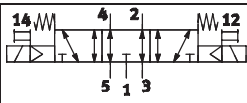
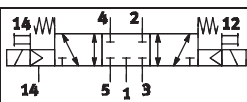
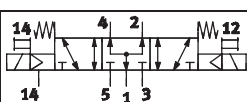
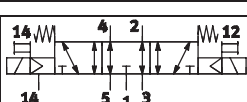
Ordering data – 5/3-way valve, double solenoid (monostable)							
Code	Circuit symbol	Normal position	Pilot air supply	Voltage		Part No.	Type
				V DC	V AC		
G		Closed	Internal	24	–	546 708	VSVA-B-P53C-H-A1-1C1
				12	–	547 146	VSVA-B-P53C-H-A1-5C1
				–	230	547 226	VSVA-B-P53C-H-A1-3AC1
				–	110	547 186	VSVA-B-P53C-H-A1-2AC1
				–	24	547 106	VSVA-B-P53C-H-A1-1AC1
B		Open	Internal	24	–	546 704	VSVA-B-P53U-H-A1-1C1
				12	–	547 142	VSVA-B-P53U-H-A1-5C1
				–	230	547 222	VSVA-B-P53U-H-A1-3AC1
				–	110	547 182	VSVA-B-P53U-H-A1-2AC1
				–	24	547 102	VSVA-B-P53U-H-A1-1AC1
E		Exhausted	Internal	24	–	546 706	VSVA-B-P53E-H-A1-1C1
				12	–	547 144	VSVA-B-P53E-H-A1-5C1
				–	230	547 224	VSVA-B-P53E-H-A1-3AC1
				–	110	547 184	VSVA-B-P53E-H-A1-2AC1
				–	24	547 104	VSVA-B-P53E-H-A1-1AC1
G		Closed	External	24	–	547 086	VSVA-B-P53C-ZH-A1-1C1
				12	–	547 166	VSVA-B-P53C-ZH-A1-5C1
				–	230	547 246	VSVA-B-P53C-ZH-A1-3AC1
				–	110	547 206	VSVA-B-P53C-ZH-A1-2AC1
				–	24	547 126	VSVA-B-P53C-ZH-A1-1AC1
B		Open	External	24	–	547 082	VSVA-B-P53U-ZH-A1-1C1
				12	–	547 162	VSVA-B-P53U-ZH-A1-5C1
				–	230	547 242	VSVA-B-P53U-ZH-A1-3AC1
				–	110	547 202	VSVA-B-P53U-ZH-A1-2AC1
				–	24	547 122	VSVA-B-P53U-ZH-A1-1AC1
E		Exhausted	External	24	–	547 084	VSVA-B-P53E-ZH-A1-1C1
				12	–	547 164	VSVA-B-P53E-ZH-A1-5C1
				–	230	547 244	VSVA-B-P53E-ZH-A1-3AC1
				–	110	547 204	VSVA-B-P53E-ZH-A1-2AC1
				–	24	547 124	VSVA-B-P53E-ZH-A1-1AC1

Solenoid valves VSVA, ISO 15407-1/plug type C



Technical data – Directional control valves width 26 mm without pilot valve

Ordering data – 2x 3/2-way valve without pilot valve					
Constructional design	Normal position	Pilot air supply	Part No.	Type	
	2x closed	Internal	546 731	VSVA-B-T32C-A-A1-P1	
	2x open	Internal	546 733	VSVA-B-T32U-A-A1-P1	

Ordering data – 5/2-way valve, single solenoid (monostable) without pilot valve					
Constructional design	Reset method	Pilot air supply	Part No.	Type	
	Pneumatic	Internal	546 739	VSVA-B-M52-A-A1-P1	
	Mechanical spring	Internal	546 741	VSVA-B-M52-M-A1-P1	

Ordering data – 5/2-way double solenoid (bi-stable) valve without pilot valve					
Constructional design	Dominance	Pilot air supply	Part No.	Type	
	1st signal	Internal	546 735	VSVA-B-B52-A1-P1	
	At 14	Internal	546 737	VSVA-B-D52-A1-P1	

Ordering data – 5/3-way mid-position valve (monostable) without pilot valve					
Constructional design	Normal position	Pilot air supply	Part No.	Type	
	Closed	Internal	546 747	VSVA-B-P53C-A1-P1	
	Open	Internal	546 743	VSVA-B-P53U-A1-P1	
	Exhausted	Internal	546 745	VSVA-B-P53E-A1-P1	

Ordering data – Pilot valve to ISO 15218								
Constructional design	Plug, square design	Protective earth conductor	Output		Voltage		Part No.	Type
			[W]	[VA]	V DC	V AC		
	DIN EN 175301-803, type C	No	1.8	–	24	–	546 256	VS-CS-B-M32-MH-WA-1C1
		No	1.8	–	12	–	546 257	VS-CS-B-M32-MH-WA-5C1
	DIN EN 175301-803, type C	Yes	–	2.1	–	230	546 260	VS-CS-B-M32-MH-WA-3AC1
		Yes	–	2.1	–	110	546 259	VS-CS-B-M32-MH-WA-2AC1
		No	–	2.3	–	24	546 258	VS-CS-B-M32-MH-WA-1AC1

Solenoid valves VSVA, ISO 15407-1/central plug M8x1

Technical data – Directional control valves width 18 mm

 Flow rate
650 l/min

 Voltage
24 V DC



General technical data								
Valve function	2x 3/2			5/2		5/3		
Normal position	C ¹⁾	U ²⁾	H ⁴⁾	–	–	C ¹⁾	U ²⁾	E ³⁾
Memory stability	Monostable				Bi-stable		Monostable	
Pneumatic spring reset method	Yes			Yes	–	No		
Mechanical spring reset method	No			Yes	–	Yes		
Design	Piston spool valve							
Sealing principle	Soft							
Actuation type	Electric							
Pilot control mode	Piloted							
Pilot air supply	Internal or external							
Direction of flow	Non-reversible			Reversible for external pilot air supply				
Exhaust function	Flow control							
Manual override	Pushing (non-detenting)							
Type of mounting	On sub-base							
Mounting position	Any							
Nominal diameter	[mm]	5						
Flow rate of valve	[l/min]	600	750		650			
Flow rate of valve on individual sub-base	[l/min]	450	550		500			
Flow rate of valve, pneumatically interlinked	[l/min]	400	550		450			
Standard nominal flow rate	[l/min]	400	550		450			
Switching time on/off, pneumatic spring	[ms]	10/22		20/25	–	–		
Switching time on/off, mechanical spring	[ms]	–		12/34	–	15/36		
Changeover time	[ms]	–			10	–		
Freedom from overlap	Yes							
Width	[mm]	18						
Ports on the sub-base	1, 2, 3, 4, 5	G1/8						
	12, 14	M5						
Tightening torque, valve mounting	[Nm]	0.68 ... 0.92						
Product weight	[g]	140	140	140				
Noise level	[dB (A)]	85						
Conforms to	ISO 15407-1							
Corrosion resistance class	CRC	2 ⁵⁾						

1) C=Normally closed

2) U=Normally open

3) E=Normally exhausted

4) H=2x 3/2-way valve in one housing with 1x normally closed and 1x normally open

5) Corrosion resistance class 2 to Festo standard 940 070

Components subject to moderate corrosion stress. Externally visible parts with primarily decorative surface requirements which are in direct contact with a normal industrial environment or media such as coolants or lubricating agents.

Solenoid valves VSVA, ISO 15407-1/central plug M8x1

Technical data – Directional control valves width 18 mm

Operating and environmental conditions				
Valve function		2x 3/2	5/2	5/3
Operating medium		Filtered compressed air, grade of filtration 40µm, lubricated or unlubricated, vacuum		
Operating pressure	Internal pilot air supply [bar]	3 ... 8		3 ... 8
	External pilot air supply [bar]	3 ... 10	-0.9 ... 10	
Pilot pressure [bar]		3 ... 8 ¹⁾	3 ... 8	3 ... 8
Ambient temperature [°C]		-5 ... +50		
Temperature of medium [°C]		-5 ... +50		
Fire protection classification to UL94		V0		

1) Pilot pressure dependent on operating pressure → Graph

Minimum pilot pressure p12, p14 as a function of the operating pressure p1 (external pilot air supply)

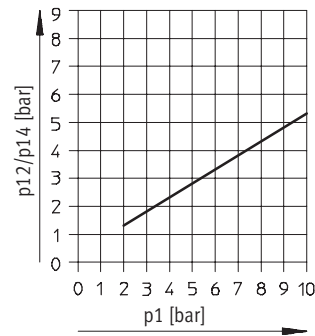

Electrical data			
Electrical connection to IEC 60 947-5-2		Central plug, round design, M8x1	
Coil characteristics	Voltage [V DC]	24±10% = 21.6 ... 26.4	
	Output [W]	High-current phase: 2.4: low-current phase: 1 ¹⁾	
Duty cycle	%	100	
Protection class to EN 60529		IP65 (in combination with plug socket)	
Protective circuit and LED		Integrated in the valve	
CE mark		89/336/EEC (EMC)	

1) Controlled by integrated current reduction

Solenoid valves VSVA, ISO 15407-1/central plug M8x1

Technical data – Directional control valves width 18 mm

Materials

Sectional view

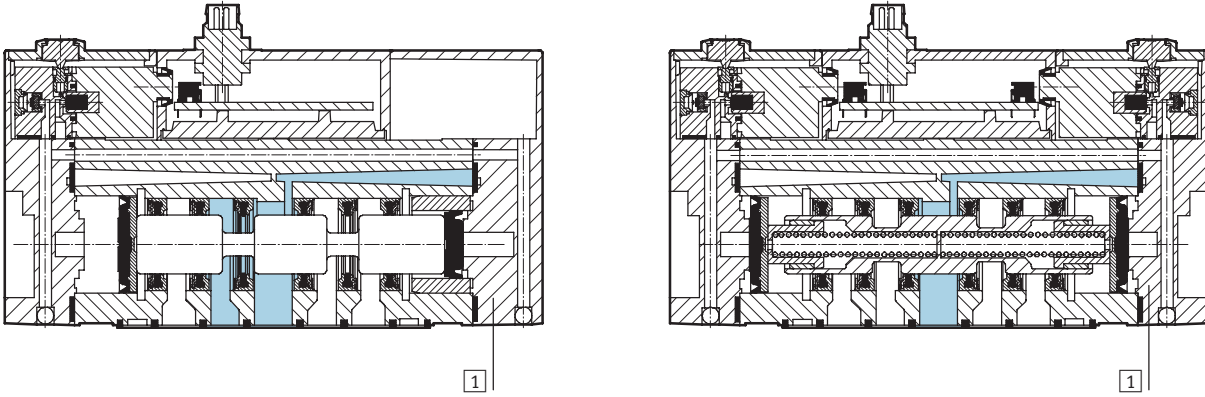

1	Housing	Die-cast aluminium, polyacetate
-	Seals	Nitrile rubber

Dimensions

Download CAD data → www.festo.com/en/engineering

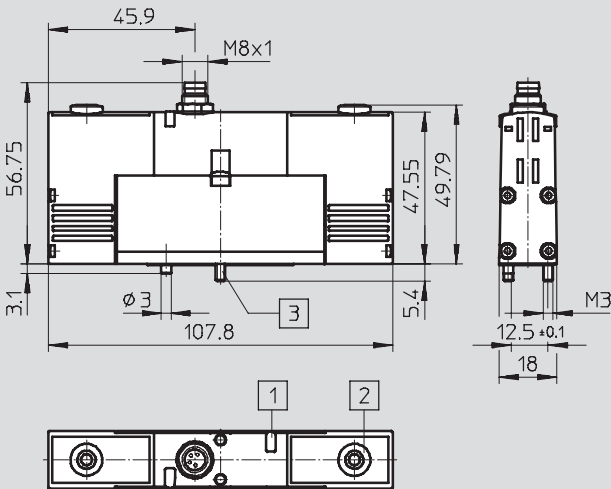

- 1 Light emitting diode (LED)
- 2 Manual override
- 3 Captive mounting screws

M8x1 – Terminal allocation

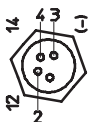

- 1 Unused
- 2 Signal (+) Solenoid 12/10
- 3 com (-)
- 4 Signal (+) Solenoid 14/10

Solenoid valves VSVA, ISO 15407-1/central plug M8x1

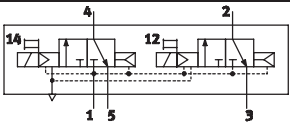
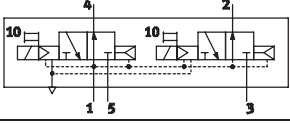
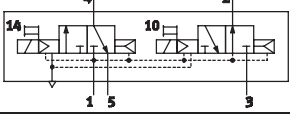
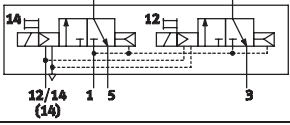
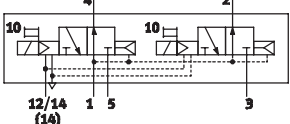
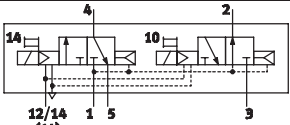

Technical data – Directional control valves width 18 mm

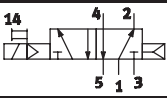
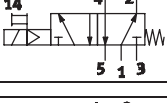
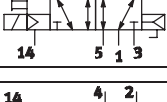
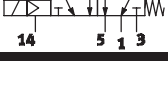
Ordering data – 2x 3/2-way valve						
Code	Circuit symbol	Normal position	Pilot air supply	Plug M8x1	Part No.	Type
K		2x closed	Internal	24 V DC	534 771	VSVA-B-T32C-AH-A2-1R2L
N		2x open	Internal	24 V DC	534 772	VSVA-B-T32U-AH-A2-1R2L
H		1x closed 1x open	Internal	24 V DC	534 773	VSVA-B-T32H-AH-A2-1R2L
K		2x closed	External	24 V DC	534 781	VSVA-B-T32C-AZH-A2-1R2L
N		2x open	External	24 V DC	534 782	VSVA-B-T32U-AZH-A2-1R2L
H		1x closed 1x open	External	24 V DC	534 783	VSVA-B-T32H-AZH-A2-1R2L

Ordering data – 5/2-way valve, single solenoid (monostable)						
Code	Circuit symbol	Reset method	Pilot air supply	Plug M8x1	Part No.	Type
M		Pneumatic	Internal	24 V DC	534 774	VSVA-B-M52-AH-A2-1R2L
O		Mechanical spring	Internal	24 V DC	534 775	VSVA-B-M52-MH-A2-1R2L
M		Pneumatic	External	24 V DC	534 784	VSVA-B-M52-AZH-A2-1R2L
O		Mechanical spring	External	24 V DC	534 785	VSVA-B-M52-MZH-A2-1R2L

Solenoid valves VSVA, ISO 15407-1/central plug M8x1

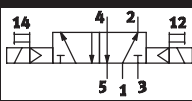
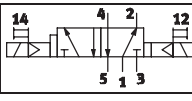
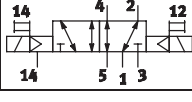
Technical data – Directional control valves 18

Ordering data – 5/2-way valve, double solenoid (bi-stable)						
Code	Circuit symbol	Dominance	Pilot air supply	Plug M8x1	Part No.	Type
J		1st signal	Internal	24 V DC	534 776	VSVA-B-B52-H-A2-1R2L
D		At 14	Internal	24 V DC	534 777	VSVA-B-D52-H-A2-1R2L
J		1st signal	External	24 V DC	534 786	VSVA-B-B52-ZH-A2-1R2L
D		At 14	External	24 V DC	534 787	VSVA-B-D52-ZH-A2-1R2L

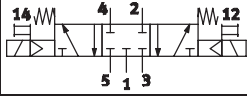
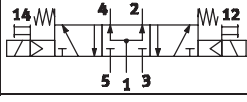
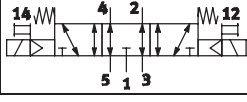
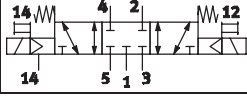
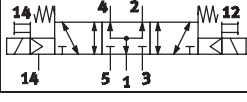
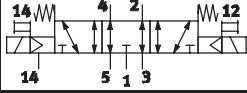
Ordering data – 5/3-way valve, double solenoid (monostable)						
Code	Circuit symbol	Normal position	Pilot air supply	Plug M8x1	Part No.	Type
G		Closed	Internal	24 V DC	534 778	VSVA-B-P53C-H-A2-1R2L
B		Open	Internal	24 V DC	534 780	VSVA-B-P53U-H-A2-1R2L
E		Exhausted	Internal	24 V DC	534 779	VSVA-B-P53E-H-A2-1R2L
G		Closed	External	24 V DC	534 788	VSVA-B-P53C-ZH-A2-1R2L
B		Open	External	24 V DC	534 790	VSVA-B-P53U-ZH-A2-1R2L
E		Exhausted	External	24 V DC	534 789	VSVA-B-P53E-ZH-A2-1R2L

Solenoid valves VSVA, ISO 15407-1/central plug M8x1, M12x1



Technical data – Directional control valves width 26 mm

 Flow rate
 1,250 ... 1,400 l/min

 Voltage
 24 V DC

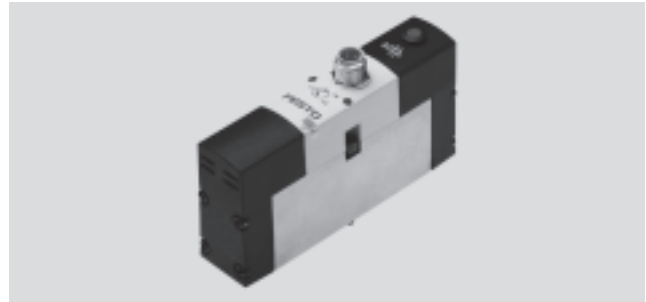

General technical data							
Valve function	2x 3/2			5/2		5/3	
Normal position	C ¹⁾	U ²⁾	H ⁴⁾	–	–	C ¹⁾	U ²⁾ E ³⁾
Memory stability	Monostable				Bi-stable	Monostable	
Pneumatic spring reset method	Yes			Yes	–	No	
Mechanical spring reset method	No			Yes	–	Yes	
Design	Piston spool valve						
Sealing principle	Soft						
Actuation type	Electric						
Pilot control mode	Piloted						
Pilot air supply	Internal or external						
Direction of flow	Non-reversible			Reversible for external pilot air supply			
Exhaust function	Flow control						
Manual override	Pushing (non-detenting)						
Type of mounting	On sub-base						
Mounting position	Any						
Nominal diameter	[mm]	9					
Flow rate of valve	[l/min]	1,250		1,400		1,400	
Flow rate of valve on individual sub-base	[l/min]	1,000		1,100		1,100	
Flow rate of valve, pneumatically interlinked	[l/min]	900		1,100		1,000	
Standard nominal flow rate	[l/min]	900		1,100		1,000	
Switching time on/off, pneumatic spring	[ms]	20/33		25/40	–	–	
Switching time on/off, mechanical spring	[ms]	–		20/52	–	20/52	
Changeover time, dominant at 1st signal	[ms]	–			15	–	
Changeover time, dominant at 14	[ms]	–			25	–	
Freedom from overlap	Yes						
Width	[mm]	26					
Ports on the sub-base	1, 2, 3, 4, 5	G1/4					
	12, 14	M5					
Tightening torque, valve mounting	[Nm]	1.62 ... 2.18					
Product weight	[g]	270					
Noise level	[dB (A)]	85					
Conforms to	ISO 15407-1						
Corrosion resistance class	CRC	2 ⁵⁾					

1) C=Normally closed

2) U=Normally open

3) E=Normally exhausted

4) H=2x 3/2-way valve in one housing with 1x normally closed and 1x normally open

5) Corrosion resistance class 2 to Festo standard 940 070

Components subject to moderate corrosion stress. Externally visible parts with primarily decorative surface requirements which are in direct contact with a normal industrial environment or media such as coolants or lubricating agents.

Solenoid valves VSVA, ISO 15407-1/central plug M8x1, M12x1

Technical data – Directional control valves width 26 mm

Operating and environmental conditions			2x 3/2	5/2	5/3
Valve function			2x 3/2	5/2	5/3
Operating medium			Filtered compressed air, grade of filtration 40µm, lubricated or unlubricated, vacuum		
Operating pressure	Internal pilot air supply	[bar]	3 ... 8		3 ... 8
	External pilot air supply	[bar]	3 ... 10	-0.9 ... 10	
Pilot pressure		[bar]	3 ... 8 ¹⁾	3 ... 8	3 ... 8
Ambient temperature		[°C]	-5 ... +50		
Temperature of medium		[°C]	-5 ... +50		
Fire protection classification to UL94			V0		

1) Pilot pressure dependent on operating pressure → Graph

Minimum pilot pressure p12, p14 as a function of the operating pressure p1 (external pilot air supply)

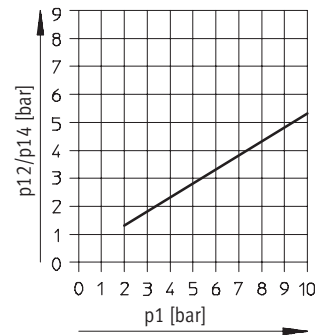

Electrical data		
Electrical connection to IEC 60 947-5-2	Central plug, round design, M8x1 or M12x1	
Coil characteristics	Voltage	[V DC] 24±10% = 21.6 ... 26.4
	Output	[W] High-current phase: 2.4; low-current phase: 1 ¹⁾
Duty cycle	%	100
Protection class to EN 60529	IP65 (in combination with plug socket)	
Protective circuit and LED	Integrated in the valve	
CE mark	89/336/EEC (EMC)	

1) Controlled by integrated current reduction

Solenoid valves VSVA, ISO 15407-1/central plug M8x1, M12x1

FESTO

Technical data – Directional control valves width 26 mm

Materials

Sectional view

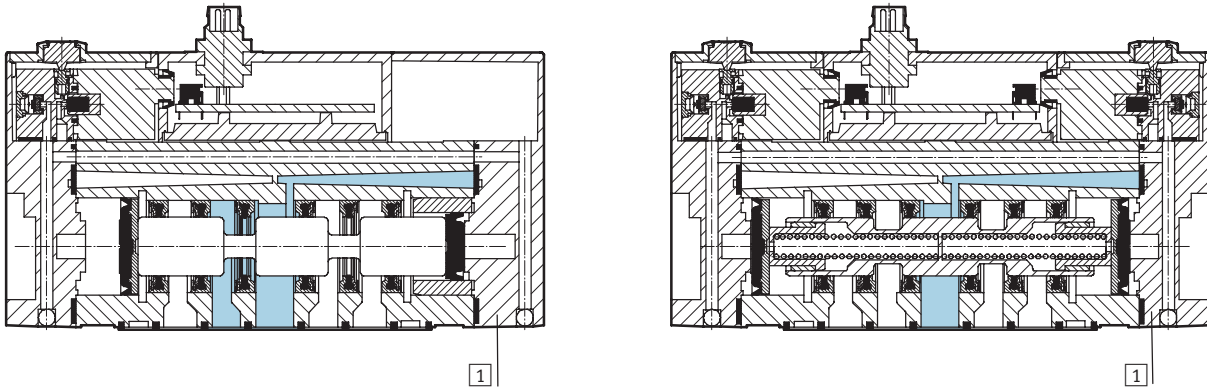

1	Housing	Die-cast aluminium, polyacetate
-	Seals	Nitrile rubber

Dimensions

Download CAD data → www.festo.com/en/engineering

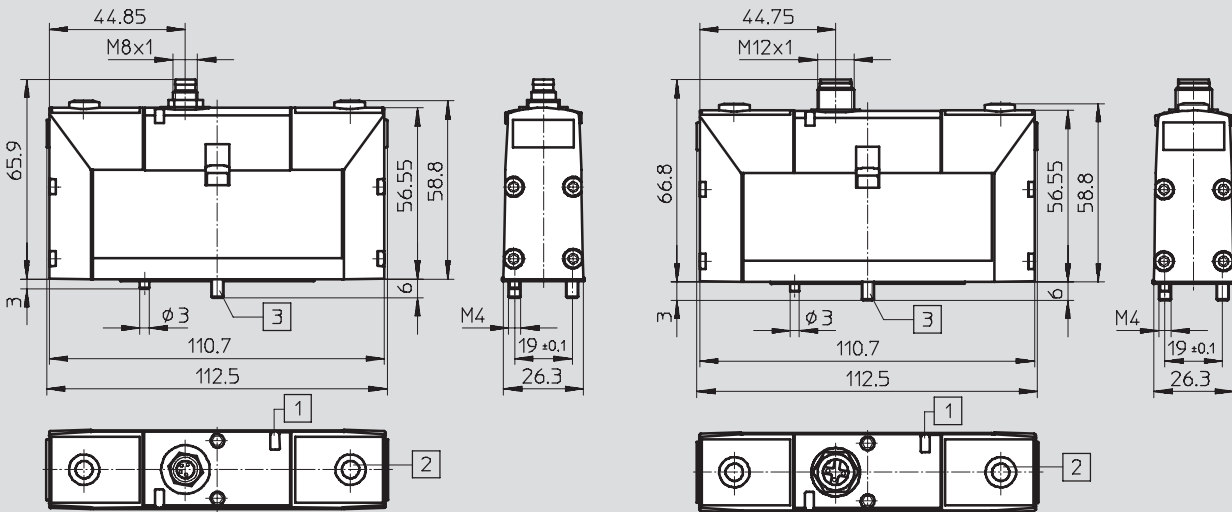

- 1 Light emitting diode (LED)
- 2 Manual override
- 3 Captive mounting screws

M8x1 – Terminal allocation

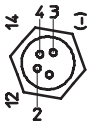

- 1 Unused
- 2 Signal (+) Solenoid 12/10
- 3 com (-)
- 4 Signal (+) Solenoid 14/10

M12x1 – Terminal allocation

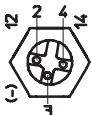



- 1 Unused
- 2 Signal (+) Solenoid 12
- 3 com (-)
- 4 Signal (+) Solenoid 14

Solenoid valves VSVA, ISO 15407-1/central plug M8x1, M12x1

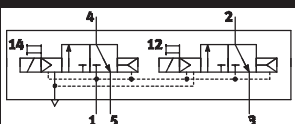
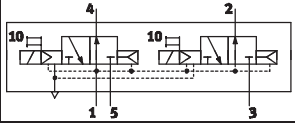
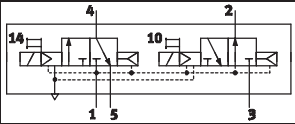
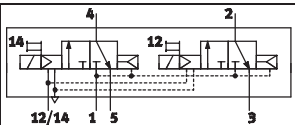
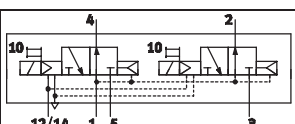
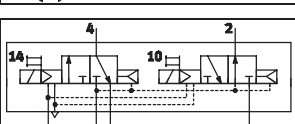

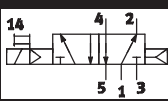
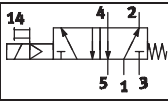
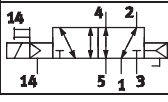
Technical data – Directional control valves width 26 mm

Ordering data – 2x 3/2-way valve							
Code	Circuit symbol	Normal position	Pilot air supply	Plug		Part No.	Type
				M8x1	M12x1		
K		2x closed	Internal	24 V DC	–	534 532	VSVA-B-T32C-AH-A1-1R2L
				–	24 V DC	534 552	VSVA-B-T32C-AH-A1-1R5L
N		2x open	Internal	24 V DC	–	534 533	VSVA-B-T32U-AH-A1-1R2L
				–	24 V DC	534 553	VSVA-B-T32U-AH-A1-1R5L
H		1x closed 1x open	Internal	24 V DC	–	534 534	VSVA-B-T32H-AH-A1-1R2L
				–	24 V DC	534 554	VSVA-B-T32H-AH-A1-1R5L
K		2x closed	External	24 V DC	–	534 522	VSVA-B-T32C-AZH-A1-1R2L
				–	24 V DC	534 542	VSVA-B-T32C-AZH-A1-1R5L
N		2x open	External	24 V DC	–	534 523	VSVA-B-T32U-AZH-A1-1R2L
				–	24 V DC	534 543	VSVA-B-T32U-AZH-A1-1R5L
H		1x closed 1x open	External	24 V DC	–	534 524	VSVA-B-T32H-AZH-A1-1R2L
				–	24 V DC	534 544	VSVA-B-T32H-AZH-A1-1R5L

Ordering data – 5/2-way valve, single solenoid (monostable)							
Code	Circuit symbol	Reset method	Pilot air supply	Plug		Part No.	Type
				M8x1	M12x1		
M		Pneumatic	Internal	24 V DC	–	534 535	VSVA-B-M52-AH-A1-1R2L
				–	24 V DC	534 555	VSVA-B-M52-AH-A1-1R5L
O		Mechanical spring	Internal	24 V DC	–	534 536	VSVA-B-M52-MH-A1-1R2L
				–	24 V DC	534 556	VSVA-B-M52-MH-A1-1R5L
M		Pneumatic	External	24 V DC	–	534 525	VSVA-B-M52-AZH-A1-1R2L
				–	24 V DC	534 545	VSVA-B-M52-AZH-A1-1R5L
O		Mechanical spring	External	24 V DC	–	534 526	VSVA-B-M52-MZH-A1-1R2L
				–	24 V DC	534 546	VSVA-B-M52-MZH-A1-1R5L

Solenoid valves VSVA, ISO 15407-1/central plug M8x1, M12x1

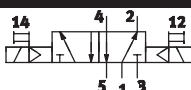
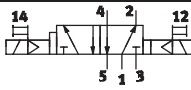
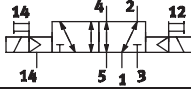
Technical data – Directional control valves width 26 mm

Ordering data – 5/2-way valve, double solenoid (bi-stable)						
Code	Circuit symbol	Dominant	Pilot air supply	Plug		Part No. Type
				M8x1	M12x1	
J		1st signal	Internal	24 V DC	–	534 537 VSVA-B-B52-H-A1-1R2L
				–	24 V DC	534 557 VSVA-B-B52-H-A1-1R5L
D		At 14	Internal	24 V DC	–	534 538 VSVA-B-D52-H-A1-1R2L
				–	24 V DC	534 558 VSVA-B-D52-H-A1-1R5L
J		1st signal	External	24 V DC	–	534 527 VSVA-B-B52-ZH-A1-1R2L
				–	24 V DC	534 547 VSVA-B-B52-ZH-A1-1R5L
D		At 14	External	24 V DC	–	534 528 VSVA-B-D52-ZH-A1-1R2L
				–	24 V DC	534 548 VSVA-B-D52-ZH-A1-1R5L

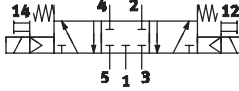
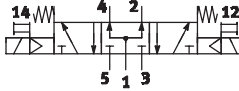
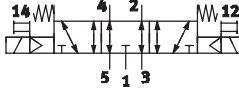
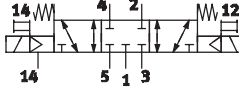
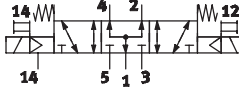
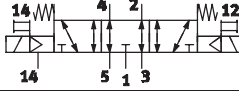
Ordering data – 5/3-way valve, double solenoid (monostable)						
Code	Circuit symbol	Normal position	Pilot air supply	Plug		Part No. Type
				M8x1	M12x1	
G		Closed	Internal	24 V DC	–	534 539 VSVA-B-P53C-H-A1-1R2L
				–	24 V DC	534 559 VSVA-B-P53C-H-A1-1R5L
B		Open	Internal	24 V DC	–	534 541 VSVA-B-P53U-H-A1-1R2L
				–	24 V DC	534 561 VSVA-B-P53U-H-A1-1R5L
E		Exhausted	Internal	24 V DC	–	534 540 VSVA-B-P53E-H-A1-1R2L
				–	24 V DC	534 560 VSVA-B-P53E-H-A1-1R5L
G		Closed	External	24 V DC	–	534 529 VSVA-B-P53C-ZH-A1-1R2L
				–	24 V DC	534 549 VSVA-B-P53C-ZH-A1-1R5L
B		Open	External	24 V DC	–	534 531 VSVA-B-P53U-ZH-A1-1R2L
				–	24 V DC	534 551 VSVA-B-P53U-ZH-A1-1R5L
E		Exhausted	External	24 V DC	–	534 530 VSVA-B-P53E-ZH-A1-1R2L
				–	24 V DC	534 550 VSVA-B-P53E-ZH-A1-1R5L

Manifold components, ISO 15407-1

Vertical stacking – Width 18 mm



Regulator plate VABF-S3-2-R ...

Material:
Housing: Die-cast aluminium
Control section: Polyamide

Regulating function:
Input pressure: 0.5 ... 10 bar

Pressure regulating ranges:
0.5 ... 6 bar, 0.5 ... 10 bar
Output pressure constant with secondary venting

 Ambient temperature
-5 ... +50 °C

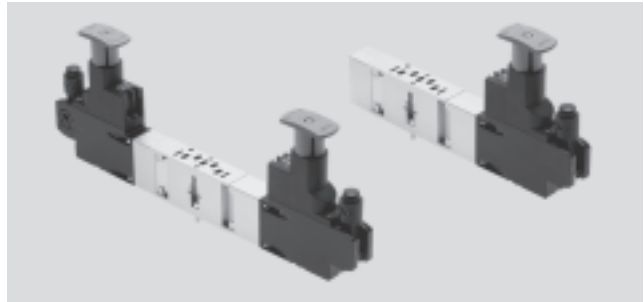

Dimensions – Width 18 mm

Download CAD data → www.festo.com/en/engineering

Regulator plate, A regulator, B regulator, AB regulator, P regulator

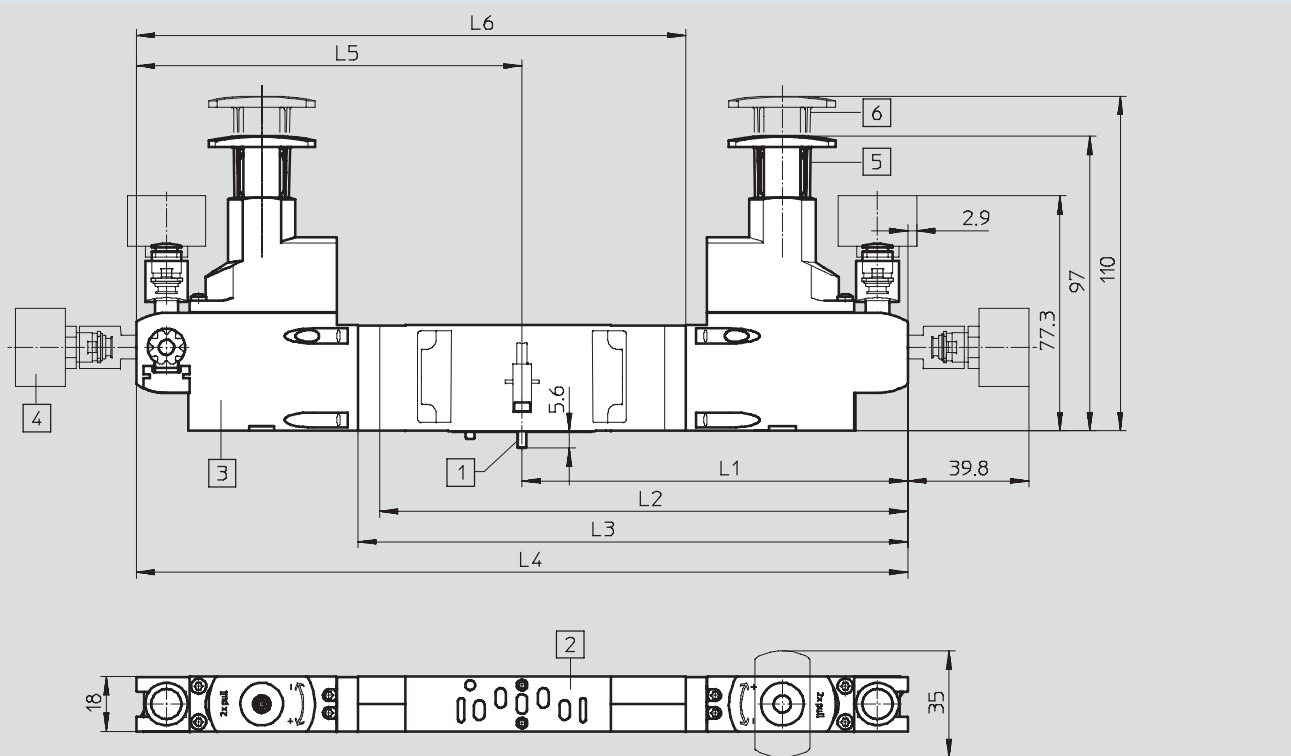

- 1 Captive screws M3x12
- 2 Port pattern to ISO 15407-1
- 3 Regulator
- 4 Pressure gauge
- 5 Regulator head in the locked state
- 6 Regulator head with pressure adjustment

Dimensions							
Type	L1	L2	L3	L4	L5	L6	Weight [g]
VABF-S3-2-R4...	126.7	–	–	253.4	–	–	650
VABF-S3-2-R5...	126.7	–	–	253.4	–	–	650
VABF-S3-2-R3...	–	–	–	–	126.7	187.7	390
VABF-S3-2-R7...	–	–	–	–	126.7	187.7	390
VABF-S3-2-R2...	126.7	–	187.7	–	–	–	390
VABF-S3-2-R6...	126.7	–	187.7	–	–	–	390
VABF-S3-2-R1...	126.7	180.6	–	–	–	–	380

Manifold components, ISO 15407-1

Vertical stacking – Width 18 mm

FESTO

Dimensions Download CAD data → www.festo.com/en/engineering

With manifold sub-base and solenoid valve (central plug)

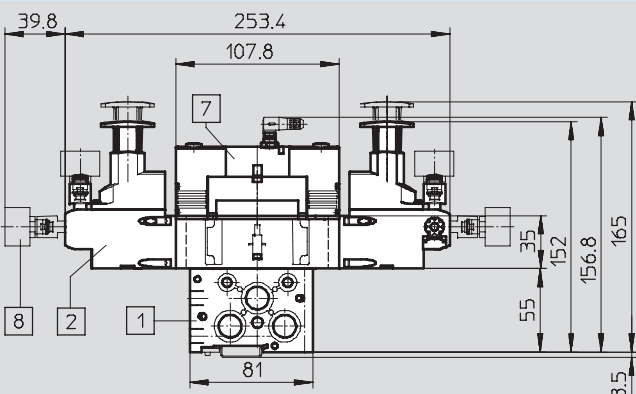

- 1 Manifold sub-base NAW
- 2 Pressure regulator plate
- 7 Solenoid valve VSVA
- 8 Pressure gauge, freely positionable

Dimensions Download CAD data → www.festo.com/en/engineering

With manifold sub-base and solenoid valve (plug type C)

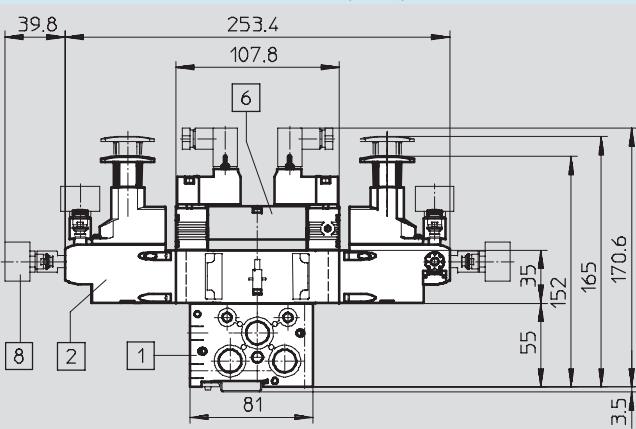

- 1 Manifold sub-base NAW
- 2 Pressure regulator plate
- 6 Solenoid valve VSVA
- 8 Pressure gauge, freely positionable

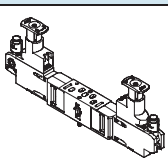
Ordering data						
Code	Designation	For connection	Regulator	Control range	Part No.	Type
Regulator plate width 18 mm						
ZA		1	P	0.5 ... 10 bar	543 526	VABF-S3-2-R1C2-C-10
ZF		1	P	0.5 ... 6 bar	543 524	VABF-S3-2-R1C2-C-6
ZB		4	A	0.5 ... 10 bar	543 530	VABF-S3-2-R3C2-C-10
ZG		4	A	0.5 ... 6 bar	543 528	VABF-S3-2-R3C2-C-6
ZC		2	B	0.5 ... 10 bar	543 534	VABF-S3-2-R2C2-C-10
ZH		2	B	0.5 ... 6 bar	543 532	VABF-S3-2-R2C2-C-6
ZD		2 and 4	AB	0.5 ... 10 bar	543 538	VABF-S3-2-R4C2-C-10
ZI		2 and 4	AB	0.5 ... 6 bar	543 536	VABF-S3-2-R4C2-C-6
ZE		2 and 4, reversible	AB	0.5 ... 10 bar	543 542	VABF-S3-2-R5C2-C-10
ZJ		2 and 4, reversible	AB	0.5 ... 6 bar	543 540	VABF-S3-2-R5C2-C-6
ZL		2, reversible	B	0.5 ... 10 bar	546 788	VABF-S3-2-R6C2-C-10
ZN		2, reversible	B	0.5 ... 6 bar	546 786	VABF-S3-2-R6C2-C-6
ZK		4, reversible	A	0.5 ... 10 bar	546 792	VABF-S3-2-R7C2-C-10
ZM		4, reversible	A	0.5 ... 6 bar	546 790	VABF-S3-2-R7C2-C-6

Manifold components, ISO 15407-1

Vertical stacking – Width 18 mm



Flow control plate VABF-S3-2-F...

Material:
Housing: Die-cast aluminium

 Ambient temperature
-5 ... +50 °C

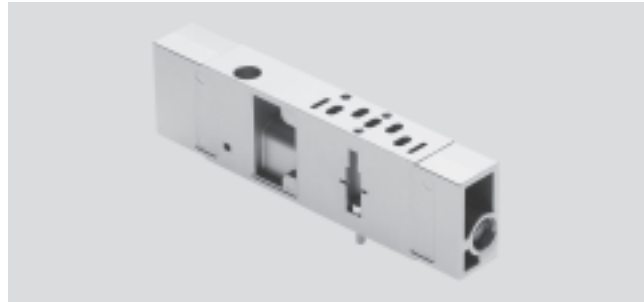

Dimensions Download CAD data → www.festo.com/en/engineering

Flow control plate width 18 mm

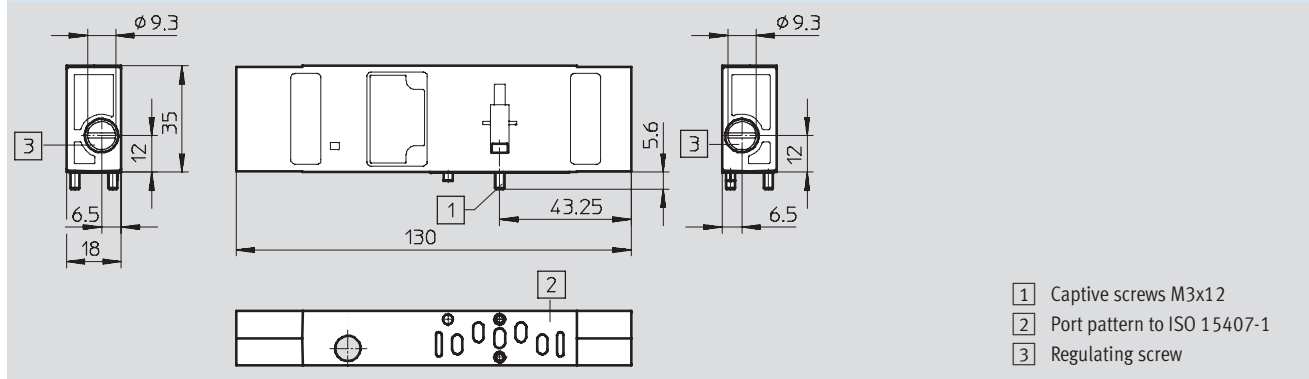

Standard directional control valves
ISO 15407-1

1.3

Dimensions Download CAD data → www.festo.com/en/engineering

With manifold sub-base and solenoid valve (central plug)

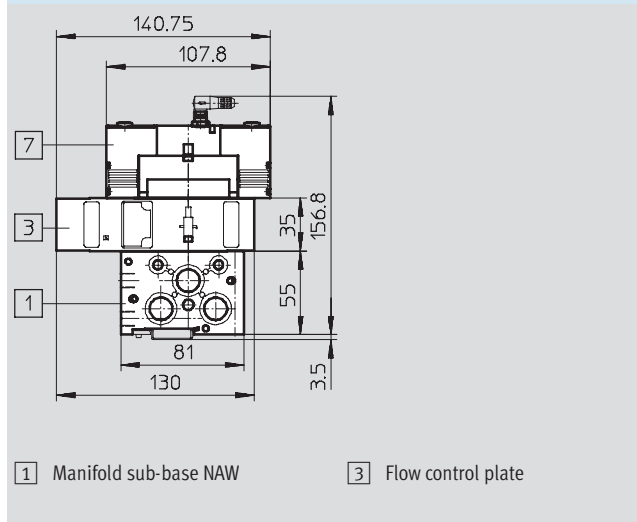

With manifold sub-base and solenoid valve (plug type C)

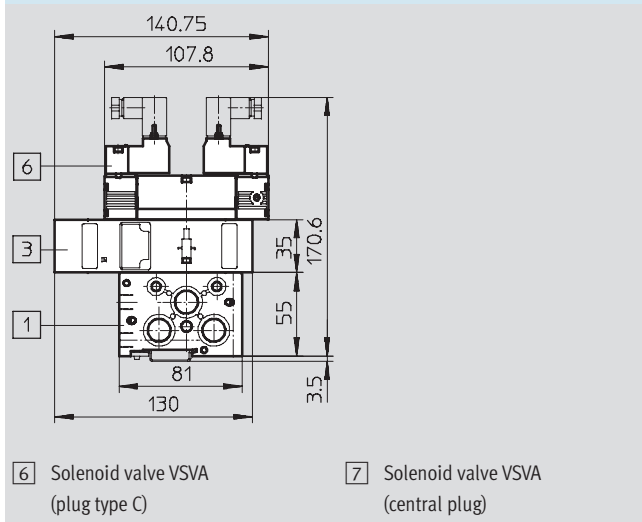

Ordering data

Code	Description	Weight [g]	Part No.	Type
X	For exhaust air flow control in ducts 3 and 5 on the valve	228	543 603	VABF-S3-2-F1B1-C

Manifold components, ISO 15407-1

Vertical stacking – Width 18 mm

FESTO

Vertical supply plate

VABF-S3-2-P ...

Material:

Housing: Die-cast aluminium

 Ambient temperature
-5 ... +50 °C

 Operating pressure
-0.9 ... +10 bar

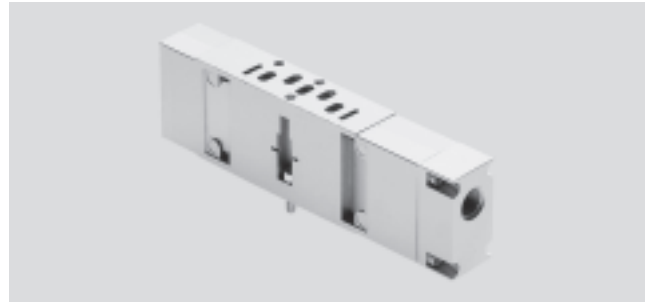

Dimensions

Download CAD data → www.festo.com/en/engineering

Vertical supply plate width 18 mm

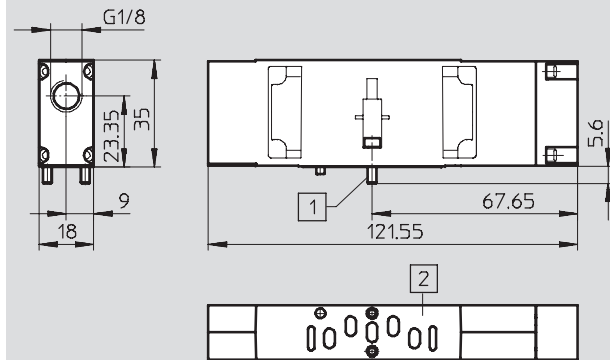

- 1 Captive screws
- 2 Port pattern to ISO 15407-1

Dimensions

Download CAD data → www.festo.com/en/engineering

With manifold sub-base and solenoid valve (central plug)

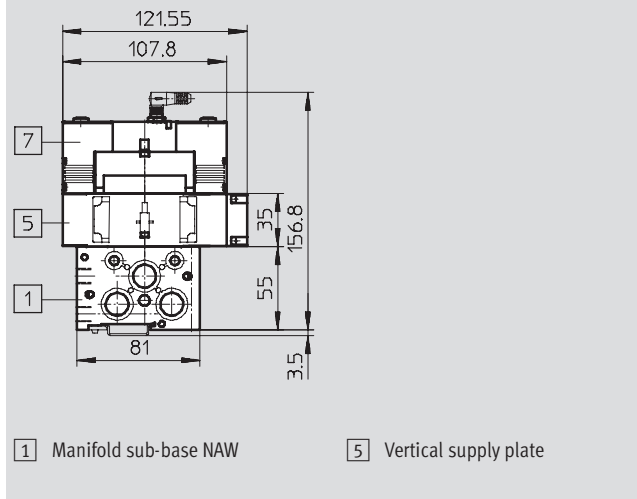

- 1 Manifold sub-base NAW
- 5 Vertical supply plate

With manifold sub-base and solenoid valve (plug type C)

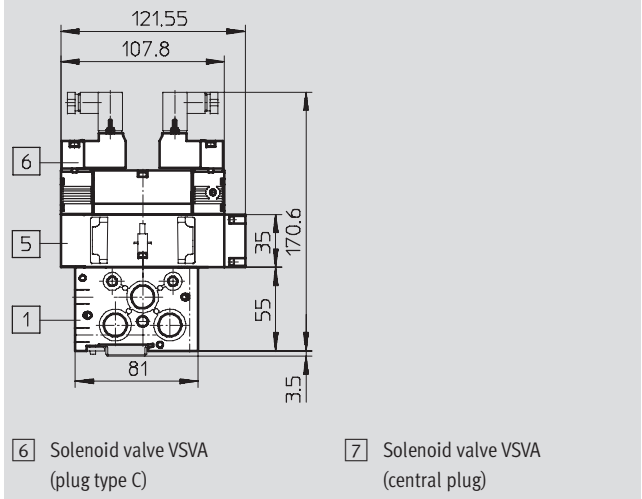

- 6 Solenoid valve VSVA (plug type C)
- 7 Solenoid valve VSVA (central plug)

Ordering data

Code	Description	Weight [g]	Part No.	Type
ZU	For the independent supply of a valve	146	544 435	VABF-S3-2-P1A3-G18

Manifold components, ISO 15407-1

Vertical stacking – Width 18 mm

Vertical shut-off plate

VABF-S3-2-L ...

Material:

Housing: Die-cast aluminium

-  Ambient temperature
-5 ... +50 °C

-  Operating pressure
-0.9 ... +10 bar



Dimensions

Download CAD data → www.festo.com/en/engineering

Vertical shut-off plate width 18 mm

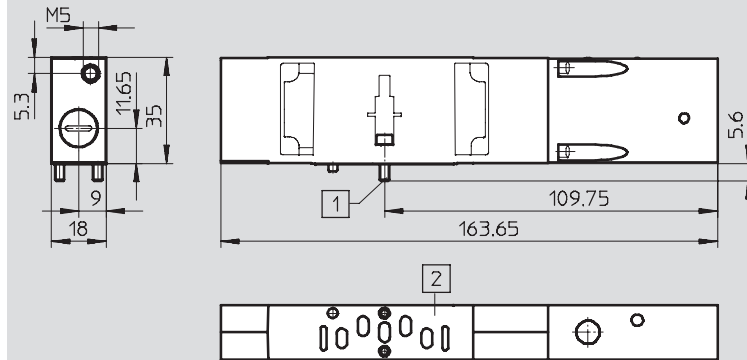

- 1 Captive screws M3x12
- 2 Port pattern to ISO 15407-1

Dimensions

Download CAD data → www.festo.com/en/engineering

With manifold sub-base and solenoid valve (central plug)

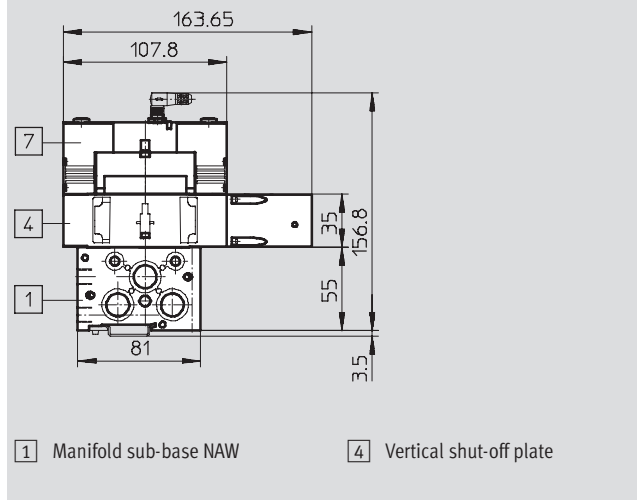

- 1 Manifold sub-base NAW
- 4 Vertical shut-off plate

With manifold sub-base and solenoid valve (plug type C)

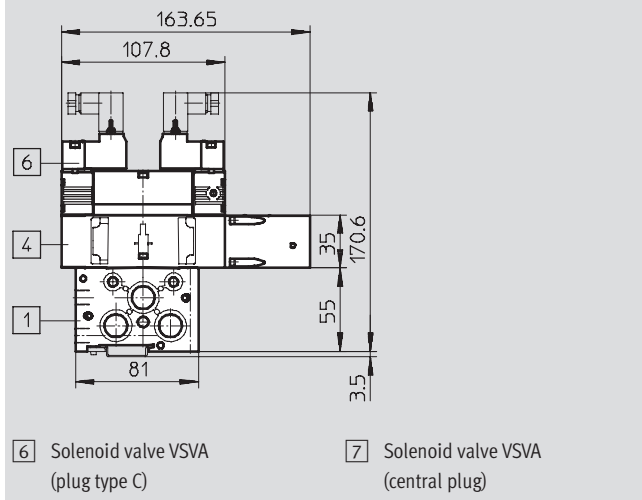

- 6 Solenoid valve VSVA (plug type C)
- 7 Solenoid valve VSVA (central plug)

Ordering data

Code	Description	Weight [g]	Part No.	Type
ZT	For shutting off a valve from the supply pressure	212	543 601	VABF-S3-2-L1D1-C

Manifold components, ISO 15407-1

Vertical stacking – Width 26 mm

Regulator plate VABF-S3-1-R ...

Material:
Housing: Die-cast aluminium
Control section: Polyamide

Regulating function:
Input pressure: 0.5 ... 10 bar

Pressure regulating ranges:
0.5 ... 6 bar, 0.5 ... 10 bar
Output pressure constant with secondary venting

 Ambient temperature
-5 ... +50 °C

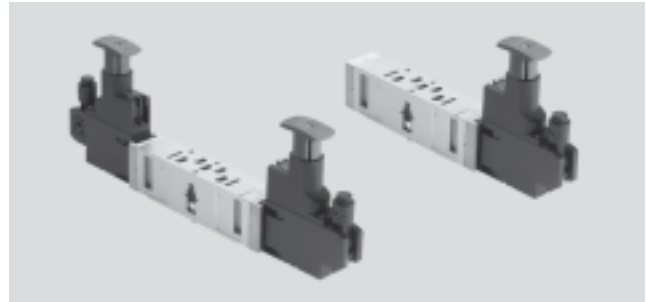

Dimensions – Width 26 mm

Download CAD data → www.festo.com/en/engineering

Regulator plate, A regulator, B regulator, AB regulator, P regulator

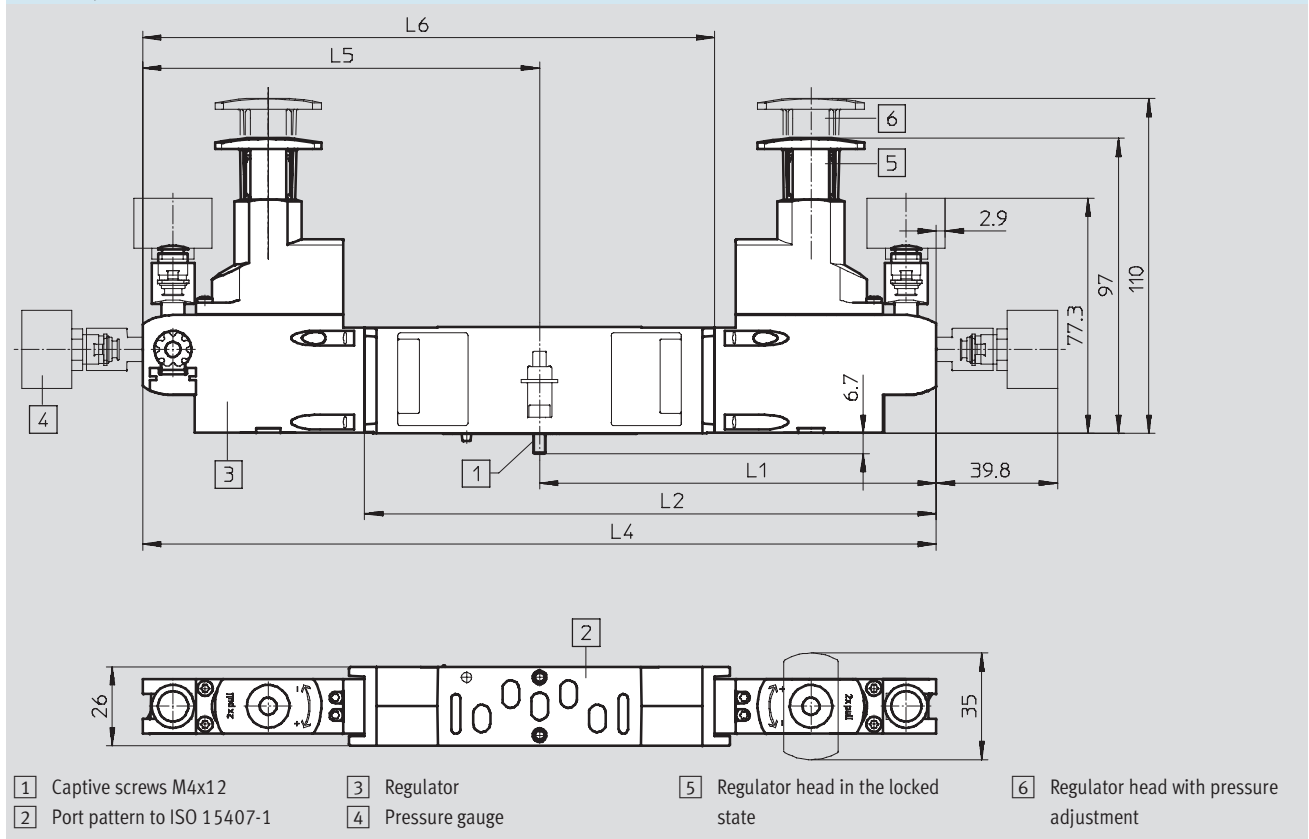

Dimensions							
Type	L1	L2	L3	L4	L5	L6	Weight [g]
VABF-S3-1-R5...	130.35	–	–	260.7	–	–	712
VABF-S3-1-R7...	–	–	–	–	130.35	192.9	452
VABF-S3-1-R6...	130.35	195	–	–	–	–	452
VABF-S3-1-R1...	130.35	183.88	–	–	–	–	439

Manifold components, ISO 15407-1

Vertical stacking – Width 26 mm

Dimensions – Width 26 mm

Download CAD data → www.festo.com/en/engineering

Regulator plate, A regulator, B regulator, AB regulator

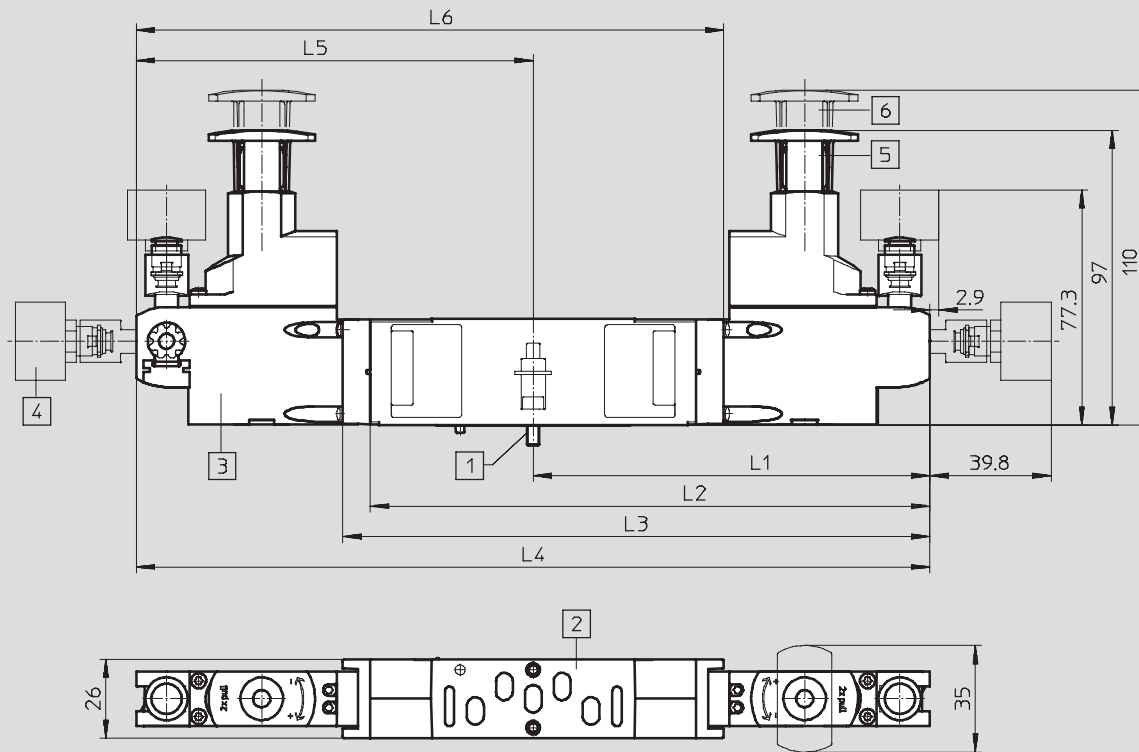

- 1 Captive screws M4x12
- 2 Port pattern to ISO 15407-1
- 3 Regulator
- 4 Pressure gauge
- 5 Regulator head in the locked state
- 6 Regulator head with pressure adjustment

Dimensions

Type	L1	L2	L3	L4	L5	L6	Weight [g]
VABF-S3-1-R4...	130.35	–	–	260.7	–	–	712
VABF-S3-1-R3...	–	–	–	–	130.35	192.9	452
VABF-S3-1-R2...	130.35	–	192.9	–	–	–	452

Manifold components, ISO 15407-1

Vertical stacking – Width 26 mm

FESTO

Dimensions Download CAD data → www.festo.com/en/engineering

With manifold sub-base and solenoid valve (central plug)

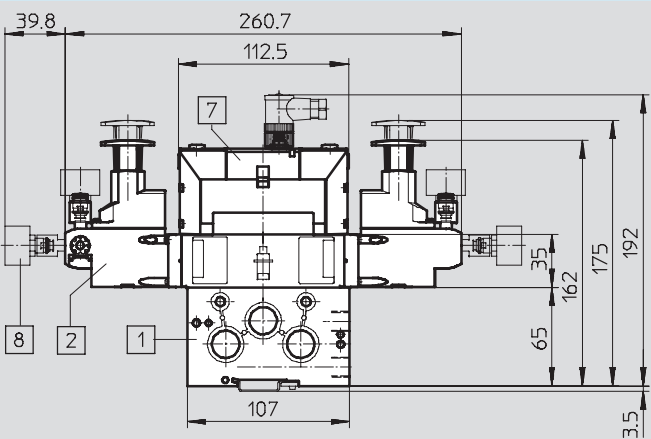

- 1 Manifold sub-base NAW
- 2 Pressure regulator plate
- 7 Solenoid valve VSVA
- 8 Pressure gauge, freely positionable

Dimensions Download CAD data → www.festo.com/en/engineering

With manifold sub-base and solenoid valve (plug type C)

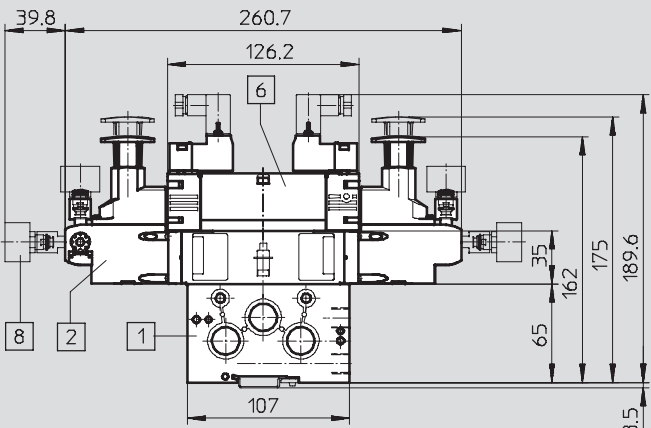

- 1 Manifold sub-base NAW
- 2 Pressure regulator plate
- 6 Solenoid valve VSVA
- 8 Pressure gauge, freely positionable

Ordering data

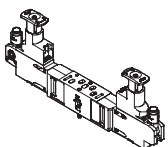
Code	Designation	For connection	Regulator	Regulating range	Part No.	Type
Regulator plate width 26 mm						
ZA		1	P	0.5 ... 10 bar	543 527	VABF-S3-1-R1C2-C-10
ZF		1	P	0.5 ... 6 bar	543 525	VABF-S3-1-R1C2-C-6
ZB		4	A	0.5 ... 10 bar	543 531	VABF-S3-1-R3C2-C-10
ZG		4	A	0.5 ... 6 bar	543 529	VABF-S3-1-R3C2-C-6
ZC		2	B	0.5 ... 10 bar	543 535	VABF-S3-1-R2C2-C-10
ZH		2	B	0.5 ... 6 bar	543 533	VABF-S3-1-R2C2-C-6
ZD		2 and 4	AB	0.5 ... 10 bar	543 539	VABF-S3-1-R4C2-C-10
ZI		2 and 4	AB	0.5 ... 6 bar	543 537	VABF-S3-1-R4C2-C-6
ZE		2 and 4, reversible	AB	0.5 ... 10 bar	543 543	VABF-S3-1-R5C2-C-10
ZJ		2 and 4, reversible	AB	0.5 ... 6 bar	543 541	VABF-S3-1-R5C2-C-6
ZL		2, reversible	B	0.5 ... 10 bar	546 789	VABF-S3-1-R6C2-C-10
ZN		2, reversible	B	0.5 ... 6 bar	546 787	VABF-S3-1-R6C2-C-6
ZK		4, reversible	A	0.5 ... 10 bar	546 793	VABF-S3-1-R7C2-C-10
ZM		4, reversible	A	0.5 ... 6 bar	546 791	VABF-S3-1-R7C2-C-6

Manifold components, ISO 15407-1

Vertical stacking – Width 26 mm

Flow control plate VABF-S3-1-F...

Material:
Housing: Die-cast aluminium

 Ambient temperature
-5 ... +50 °C

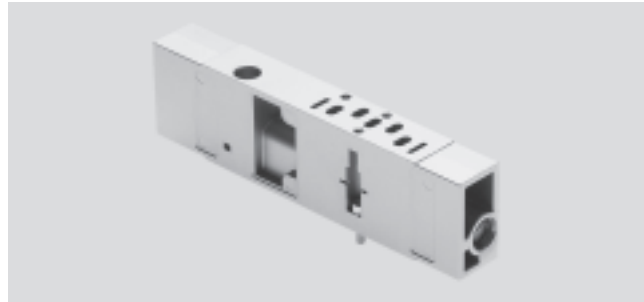

Dimensions – Width 26 mm

Download CAD data → www.festo.com/en/engineering

Flow control plate

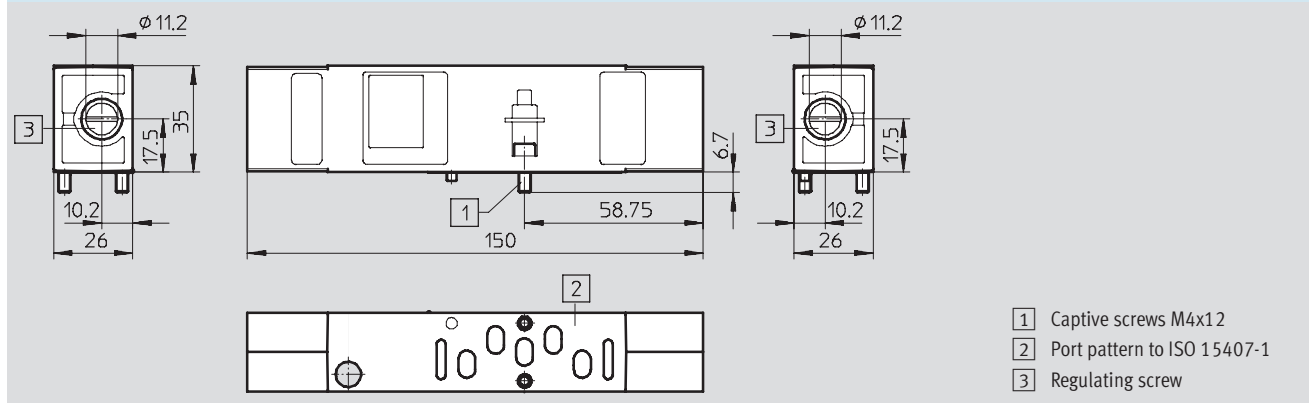

Dimensions

Download CAD data → www.festo.com/en/engineering

With manifold sub-base and solenoid valve (central plug)

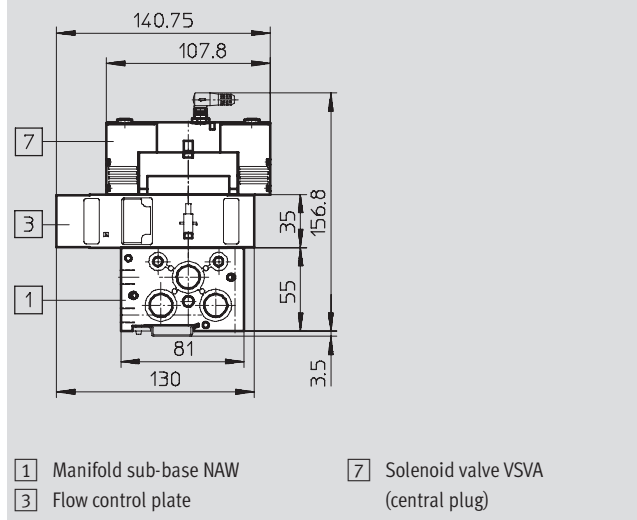

With manifold sub-base and solenoid valve (plug type C)

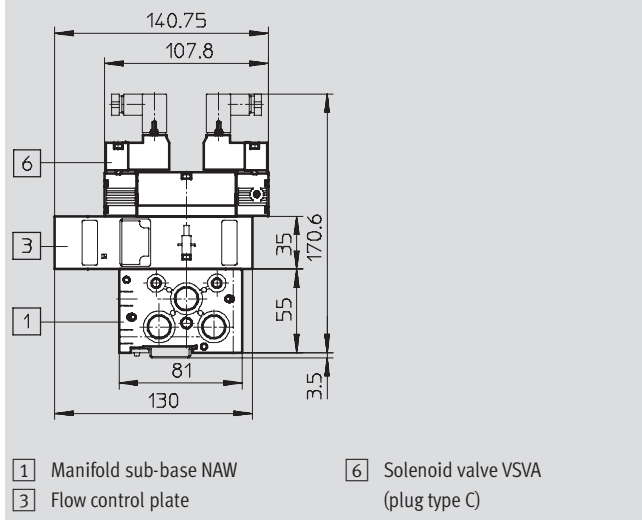

Ordering data

Code	Description	Weight [g]	Part No.	Type
X	For exhaust air flow control in ducts 3 and 5 on the valve	320	543 604	VABF-S3-1-F1B1-C

Manifold components, ISO 15407-1

Vertical stacking – Width 26 mm

Vertical supply plate

VABF-S3-1-P ...

Material:

Housing: Die-cast aluminium

 Ambient temperature
-5 ... +50 °C

 Operating pressure
-0.9 ... +10 bar



Dimensions – Width 26 mm

Download CAD data → www.festo.com/en/engineering

Vertical supply plate

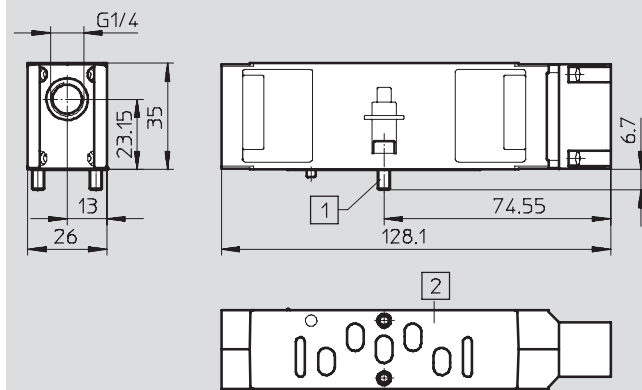

- 1 Captive screws M4x12
- 2 Port pattern to ISO 15407-1

Dimensions

Download CAD data → www.festo.com/en/engineering

With manifold sub-base and solenoid valve (central plug)

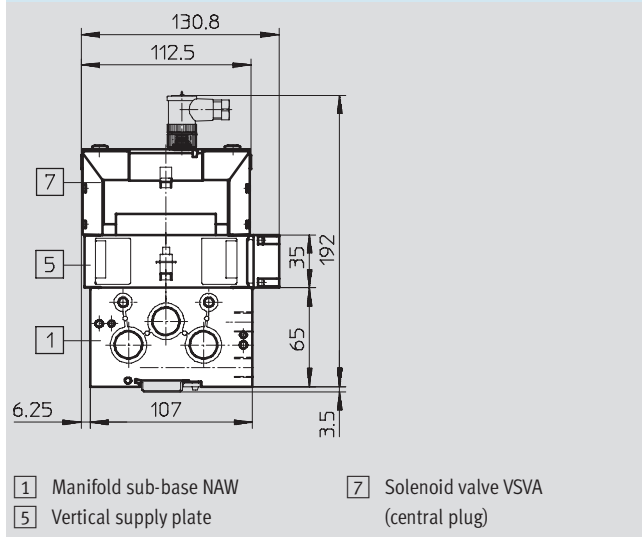

- 1 Manifold sub-base NAW
- 5 Vertical supply plate
- 7 Solenoid valve VSVA (central plug)

With manifold sub-base and solenoid valve (plug type C)

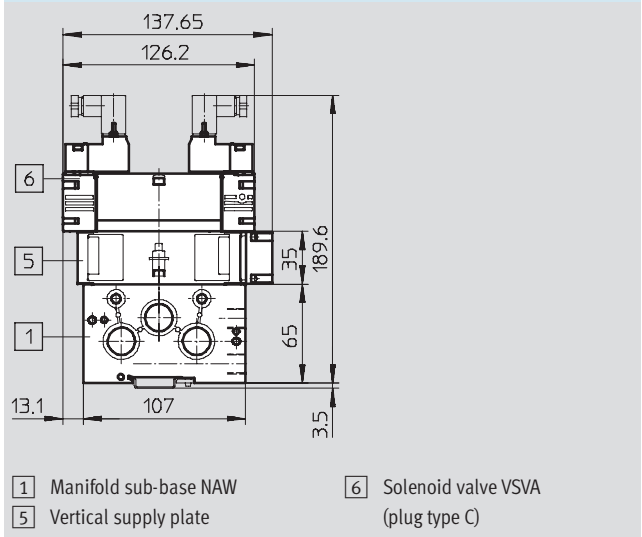

- 1 Manifold sub-base NAW
- 5 Vertical supply plate
- 6 Solenoid valve VSVA (plug type C)

Ordering data

Code	Description	Weight [g]	Part No.	Type
ZU	For the independent supply of a valve	201	544 434	VABF-S3-1-P1A3-G14

Manifold components, ISO 15407-1

Vertical stacking – Width 26 mm

Vertical shut-off plate

VABF-S3-1-L ...

Material:

Housing: Die-cast aluminium

 Ambient temperature
-5 ... +50 °C

 Operating pressure
-0.9 ... +10 bar

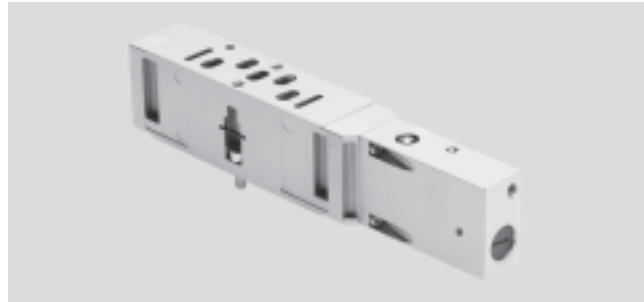

Dimensions – Width 26 mm

Download CAD data → www.festo.com/en/engineering

Vertical shut-off plate

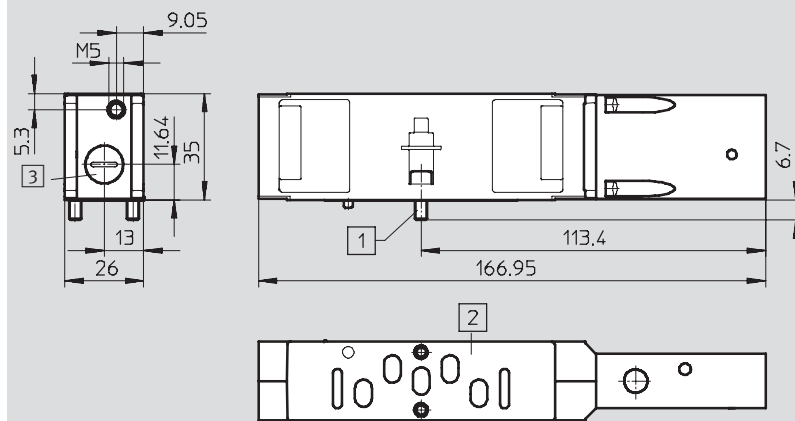

- 1 Captive screws M4x12
- 2 Port pattern to ISO 15407-1
- 3 Plug screw

Dimensions

Download CAD data → www.festo.com/en/engineering

With manifold sub-base and solenoid valve (central plug)

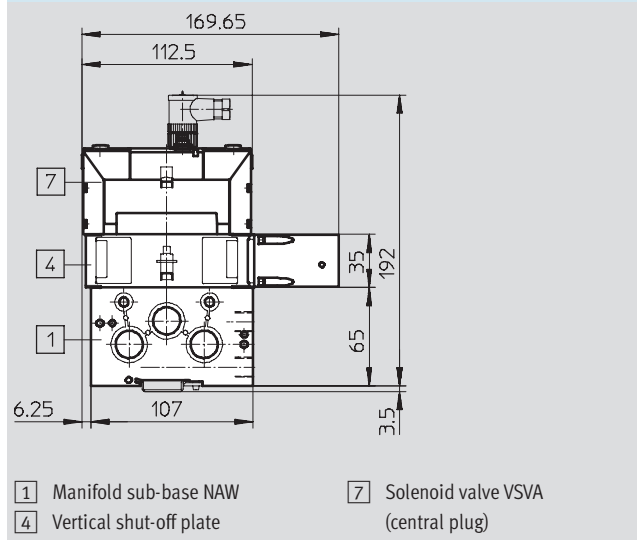

- 1 Manifold sub-base NAW
- 4 Vertical shut-off plate
- 7 Solenoid valve VSVA (central plug)

With manifold sub-base and solenoid valve (plug type C)

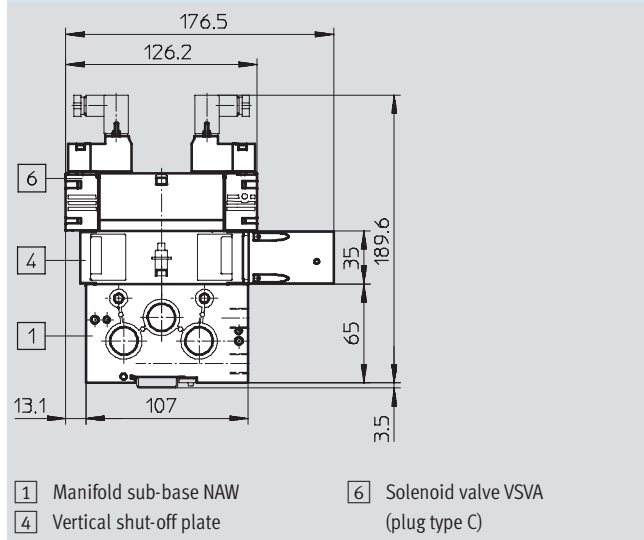

- 1 Manifold sub-base NAW
- 4 Vertical shut-off plate
- 6 Solenoid valve VSVA (plug type C)

Ordering data

Code	Description	Weight [g]	Part No.	Type
ZT	For shutting off a valve from the supply pressure	286	543 602	VABF-S3-1-L1D1-C

Sub-bases, ISO 15407-1



Individual sub-base

Individual sub-base NAS

Materials:
Die-cast aluminium

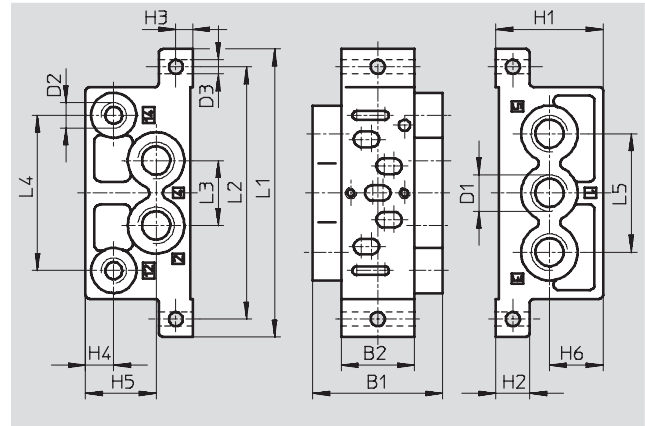
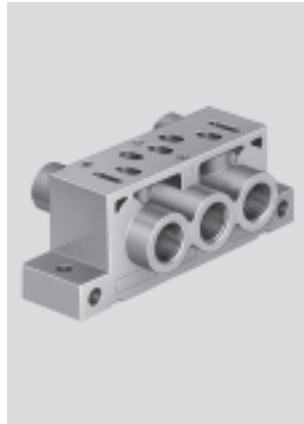

Dimensions and ordering data											
Width [mm]	B1	B2	D1	D2	D3 Ø	H1	H2	H3	H4	H5	H6
18	28.5	18	G $\frac{1}{8}$	M5	5.5	31	10	5	7	20	14.5
26	46	26	G $\frac{1}{4}$	G $\frac{3}{8}$	5	38	12	6	10	25	19

Dimensions and ordering data									
Width [mm]	L1	L2	L3	L4	L5	Weight [g]	Part No.	Type	
18	79	66.5	17	40	32	67	161 115	NAS- $\frac{1}{8}$ -02-VDMA	
26	102	89.4	23	55	42	160	161 109	NAS- $\frac{1}{4}$ -01-VDMA	

General technical data		
Width [mm]	18	26
Type of mounting	2 through-holes in housing	
Pneumatic connection	1, 2, 3, 4, 5	G $\frac{1}{8}$
	12, 14	M5
		G $\frac{1}{8}$

Standard directional control valves
ISO 15407-1

1.3

Manifold components, ISO 15407-1

Horizontal linking



Manifold sub-base NAW

Material:
Die-cast aluminium

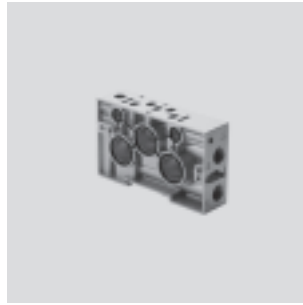

Ordering data – NAW for solenoid valves					
Width [mm]	Pneumatic connection		Weight [g]	Part No.	Type
	1, 2, 3, 4, 5	12, 14			
18	G $\frac{1}{8}$	M5	130	161 110	NAW- $\frac{1}{8}$ -02-VDMA
26	G $\frac{1}{4}$	M5	225	161 102	NAW- $\frac{1}{4}$ -01-VDMA

Ordering data – NAW for pneumatic valves					
Width [mm]	Pneumatic connection		Weight [g]	Part No.	Type
	1, 2, 3, 4, 5	12, 14			
18	G $\frac{1}{8}$	M5	130	161 111	NAW- $\frac{1}{8}$ -02-VDMA-VL
26	G $\frac{1}{4}$	M5	225	161 103	NAW- $\frac{1}{4}$ -01-VDMA-VL

Dimensions → 2 / 1.3-60

Standard directional control valves
ISO 15407-1

1.3

End plate kit NEV

Material:
Die-cast aluminium

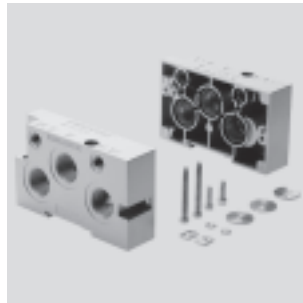

Ordering data					
Width [mm]	Pneumatic connection		Weight [g]	Part No.	Type
	1, 2, 3, 4, 5	12, 14			
18	G $\frac{3}{8}$	G $\frac{1}{8}$	280	161 112	NEV-02-VDMA
26	G $\frac{1}{2}$	G $\frac{1}{8}$	445	161 104	NEV-01-VDMA

Dimensions → 2 / 1.3-60

Manifold components, ISO 15407-1

Horizontal linking

End plate kit NEV

For combi manifold with widths of 18 and 26

Material:
Die-cast aluminium



Ordering data				
Width [mm]	Description	Weight [g]	Part No.	Type
18 and 26	One end plate of width 18 mm, one end plate of width 26 mm and fittings	372	191 405	NEV-02-01-VDMA

Dimensions → 2 / 1.3-60

Intermediate plate NZV

For combi manifold with widths of 18 and 26

Material:
Die-cast aluminium



Dimensions Download CAD data → www.festo.com/en/engineering

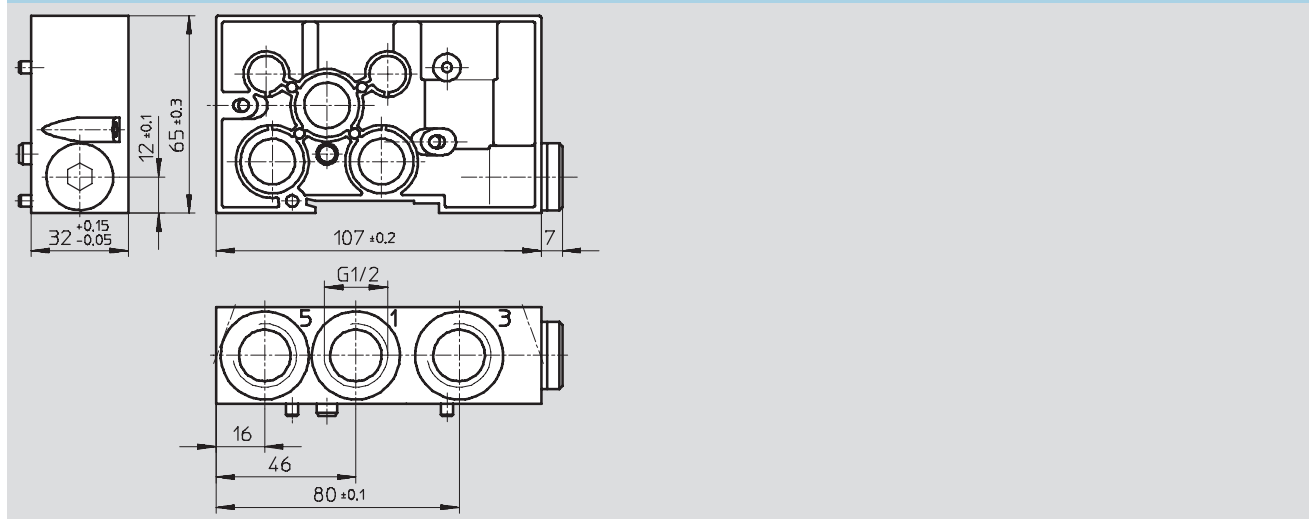

Ordering data					
Width [mm]	Pneumatic connection		Weight [g]	Part No.	Type
	1, 2, 3, 4, 5	12, 14			
18 and 26	G1/2	-	270	161 108	NZV-01/02-VDMA

Manifold components, ISO 15407-1

Horizontal linking



Dimensions – Manifold assembly

Download CAD data → www.festo.com/en/engineering

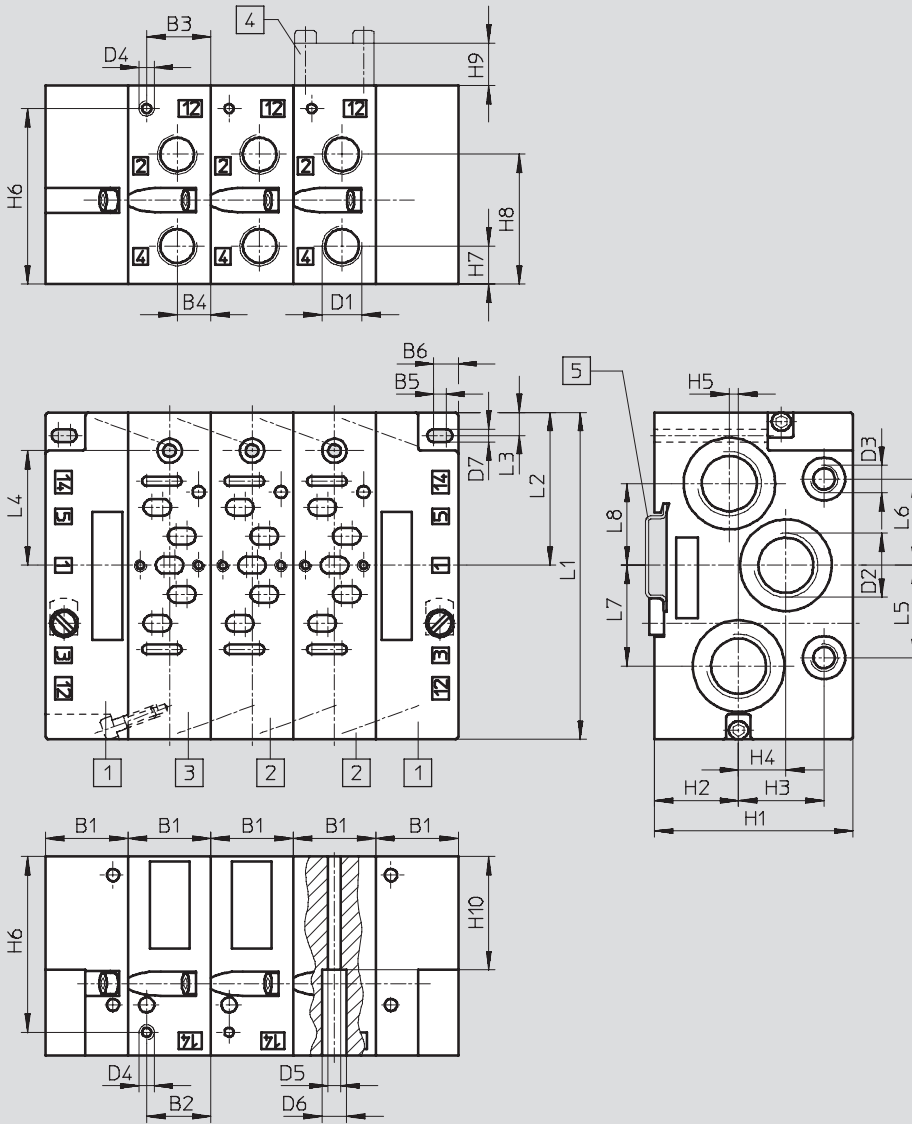

- 1 End plate kit
NEV-...VDMA
→ 2 / 1.3-58
- 2 Manifold sub-base
NAW-...VDMA
→ 2 / 1.3-58
- 3 Manifold sub-base
NAW-...VDMA-VL
→ 2 / 1.3-58
- 4 Blanking plate
NDV-...VDMA
→ 2 / 1.3-65
- 5 Mounting rail
NRH-35-2000
→ 2 / 7.8-1

Width [mm]	B1	B2	B3	B4	B5	B6	D1	D2	D3	D4
18	19	6	13	7.5	1	4.5	G1/8	G3/8	G1/8	M5
26	27	21	21	11	4	8	G1/4	G1/2	G1/8	M5

Width [mm]	D5	D6	D7	H1	H2	H3	H4	H5	H6	H7
18	3.3	6.3	4.3	55	17	28.8	18.5	–	48	10.5
26	4.2	8	4.2	65	27.5	28	15.5	3	57.5	12.5

Width [mm]	H8	H9	H10	L1	L2	L3	L4	L5	L6	L7	L8
18	35.5	12	40	81	36.5	5.6	30.9	20	20	18	18
26	42.5	14	37	107	50	7.5	37.5	30.3	28.3	33	26.8

Manifold components, ISO 15407-1

Horizontal linking

FESTO

Dimensions – Manifold assembly, width 18 mm

Download CAD data → www.festo.com/en/engineering

Valves with square plug, type C

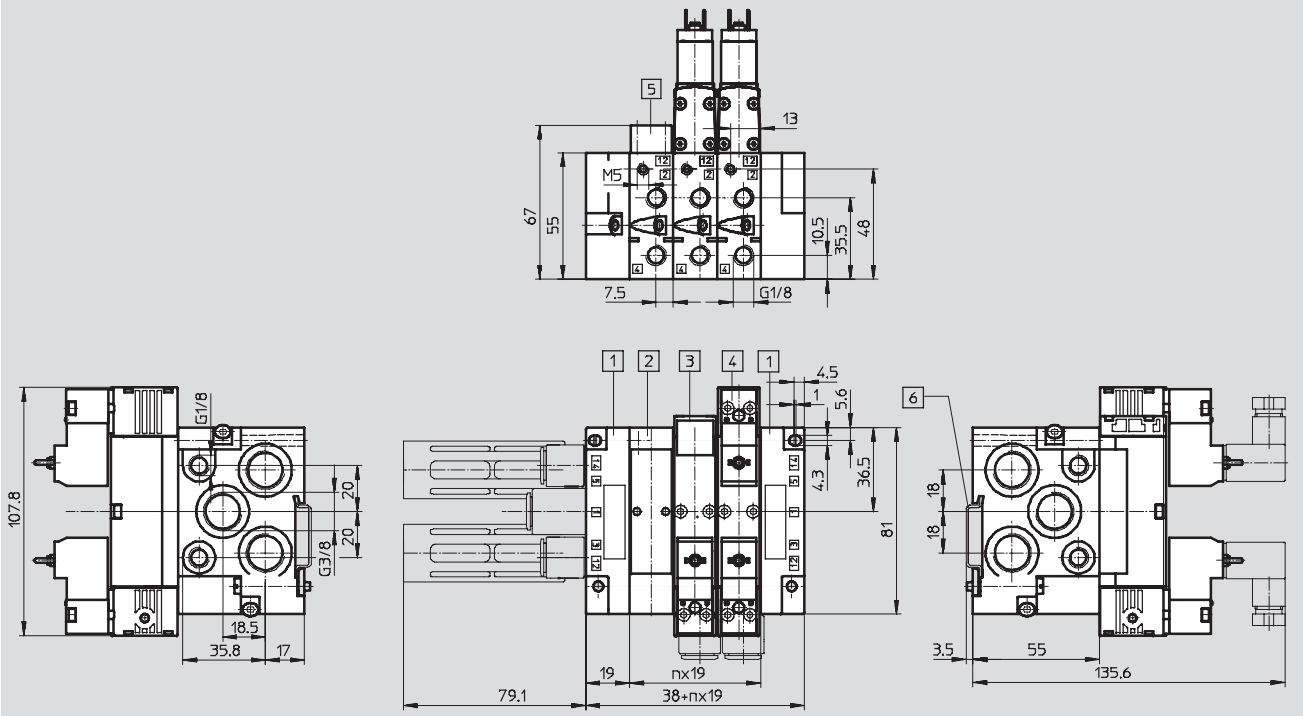

- 1 End plate kit type NEV-02-VDMA
- 2 Manifold sub-bases type NAW-1/8-02-VDMA
- 3 Solenoid valve VSVA (single solenoid)
- 4 Solenoid valve VSVA (double solenoid)
- 5 Blanking plate NDV-02-VDMA
- 6 Mounting rail NRH-35-2000

Standard directional control valves
ISO 15407-1

1.3

Manifold components, ISO 15407-1

Horizontal linking



Dimensions – Manifold assembly, width 18 mm

Download CAD data → www.festo.com/en/engineering

Valves with central plug M8x1

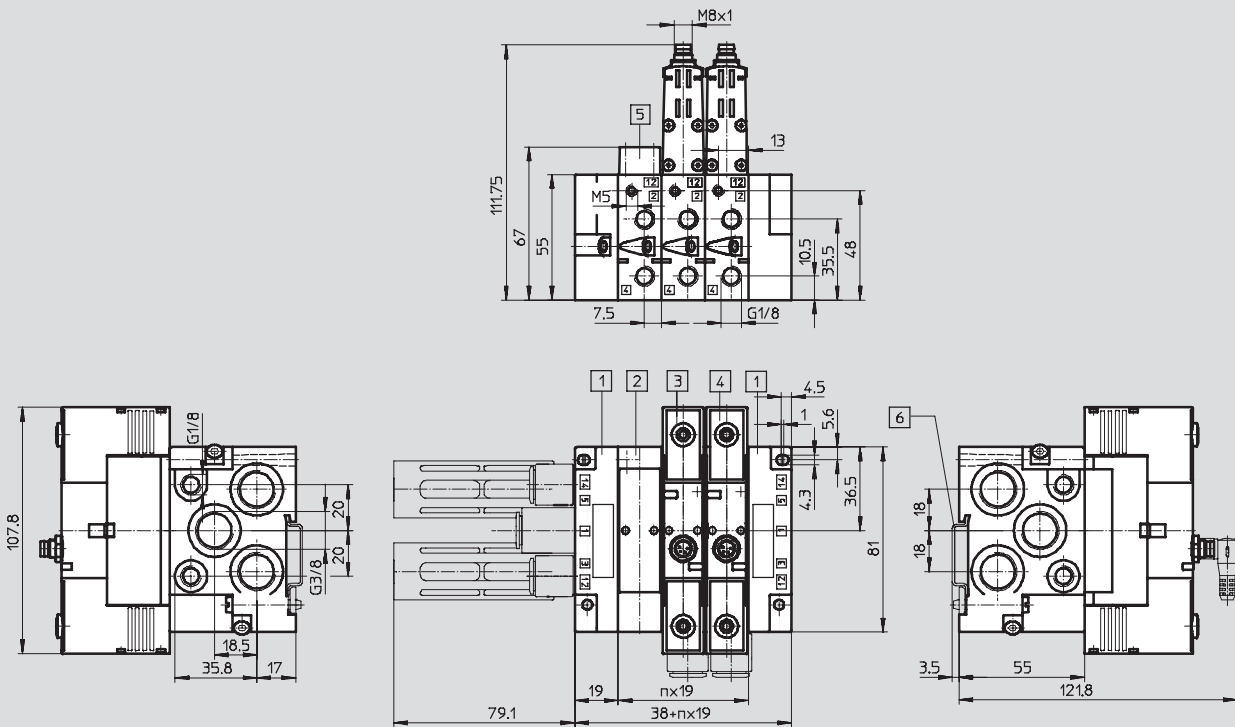

- | | | | |
|--|--------------------------------------|------------------------------|-----------------------------|
| 1 End plate kit
type NEV-02-VDMA | 3 Solenoid valve VSVA
(plug M8x1) | 5 Blanking plate NDV-02-VDMA | 6 Mounting rail NRH-35-2000 |
| 2 Manifold sub-bases type
NAW-1/8-02-VDMA | 4 Solenoid valve VSVA
(plug M8x1) | | |

Manifold components, ISO 15407-1

Horizontal linking



Dimensions – Manifold assembly, width 26 mm

Download CAD data → www.festo.com/en/engineering

Valves with square plug, type C

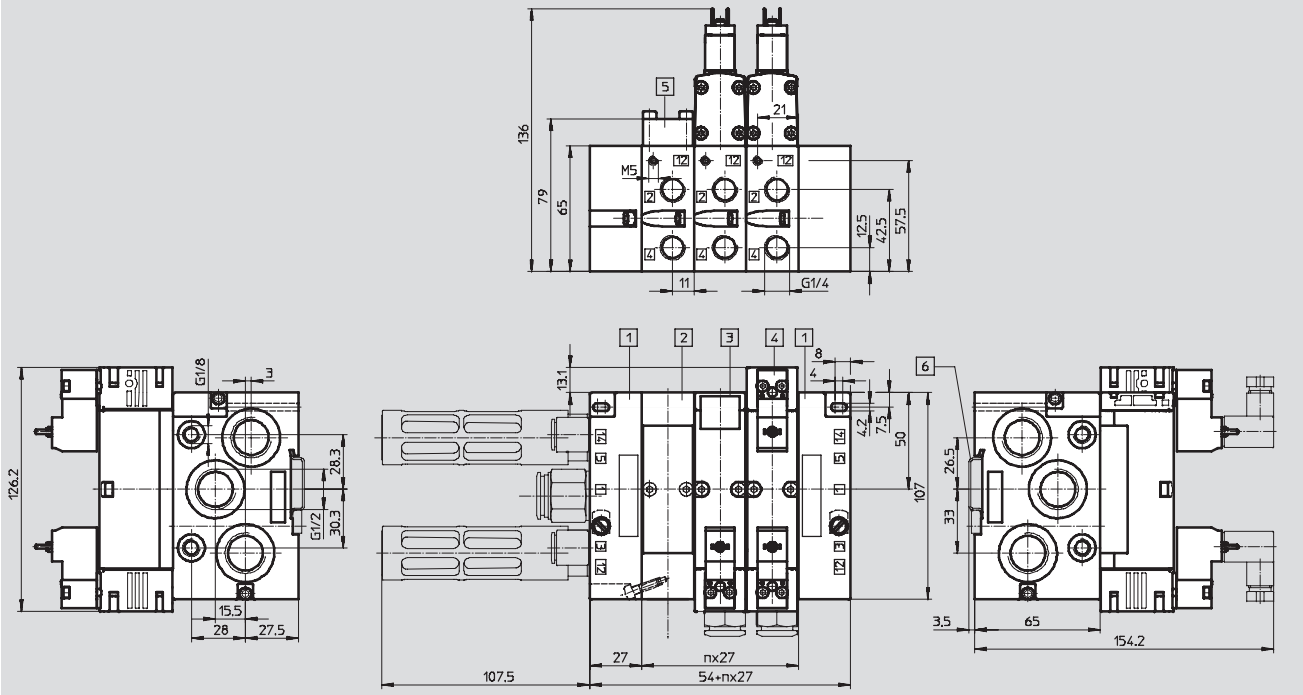

- 1 End plate kit type NEV-01-VDMA
- 2 Manifold sub-bases type NAW-1/4-01-VDMA
- 3 Solenoid valve VSVA (single solenoid)
- 4 Solenoid valve VSVA (double solenoid)
- 5 Blanking plate NDV-01-VDMA
- 6 Mounting rail NRH-35-2000

Standard directional control valves
ISO 15407-1

1.3

Manifold components, ISO 15407-1

Horizontal linking

FESTO

Dimensions – Manifold assembly, width 26 mm

Download CAD data → www.festo.com/en/engineering

Valves with central plug M8x1, M12x1

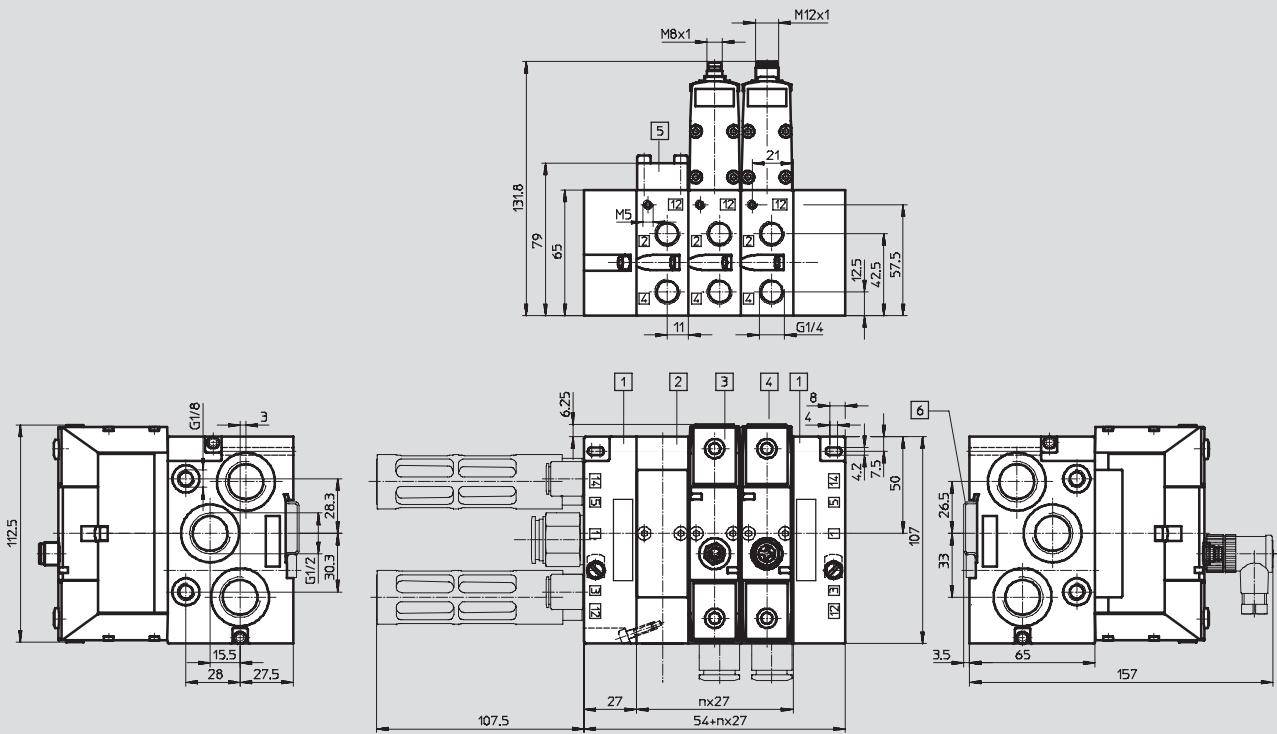

- | | | | |
|---|------------------------------------|------------------------------|-----------------------------|
| 1 End plate kit type NEV-01-VDMA | 3 Solenoid valve VSVA (plug M8x1) | 5 Blanking plate NDV-01-VDMA | 6 Mounting rail NRH-35-2000 |
| 2 Manifold sub-bases type NAW-1/4-01-VDMA | 4 Solenoid valve VSVA (plug M12x1) | | |

Manifold components, ISO 15407-1

Horizontal linking

Isolating disc NSC

Material:
Aluminium



Ordering data – NSC for ports 1, 2, 3 (solenoid/pneumatic valves)			
Width [mm]	Weight [g]	Part No.	Type
18	2	161 113	NSC- $\frac{3}{8}$ -02-VDMA
26	2	161 105	NSC- $\frac{1}{2}$ -01-VDMA

Ordering data – NSC for ports 12, 14 (pneumatic valves)			
Width [mm]	Weight [g]	Part No.	Type
18	2	161 106	NSC- $\frac{1}{8}$ -01-VDMA
26	2	161 106	NSC- $\frac{1}{8}$ -01-VDMA

Blanking plate NDV

Material:
Polymer
Free of copper and PTFE

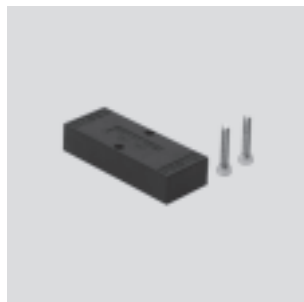





Ordering data			
Width [mm]	Weight [g]	Part No.	Type
18	22	161 114	NDV-02-VDMA
26	36	161 107	NDV-01-VDMA



Dimensions →



Pneumatic valves, VSPA, ISO 15 407-1

Product range overview

Function	Variant	Type	Flow rate of valve [l/min]	Working port on sub-base		Normal position			→ Page
				G $\frac{3}{8}$	G $\frac{1}{4}$	2x closed (C)	2x open (U)	1x (C) 1x (U) C/U=H	
2x3/2-way valves, monostable	Width 18 mm, pneumatically actuated valve								
		VSPA-B-T32...A2	550	■	-	■	■	■	2 / 1.3-71
	Width 26 mm, pneumatically actuated valve								
		VSPA-B-T32...A1	1,250	-	■	■	■	■	2 / 1.3-74

Function	Variant	Type	Flow rate of valve [l/min]	Working port on sub-base		Reset method		→ Page	
				G $\frac{3}{8}$	G $\frac{1}{4}$	Pneumatic spring	Mechanical spring		
5/2-way valves, monostable	Width 18 mm, pneumatically actuated valve								
		VSPA-B-B52...A2	700	■	-	■	■	2 / 1.3-71	
	Width 26 mm, pneumatically actuated valve								
		VSPA-B-B52...A1	1,400	-	■	■	■	2 / 1.3-74	

Function	Variant	Type	Flow rate of valve [l/min]	Working port on sub-base		Dominant		→ Page	
				G $\frac{3}{8}$	G $\frac{1}{4}$	1st signal	At 14		
5/2-way valves, bi-stable	Width 18 mm, pneumatically actuated valve								
		VSPA-B-M52...A2	700	■	-	■	■	2 / 1.3-71	
	Width 26 mm, pneumatically actuated valve								
		VSPA-B-M52...A1	1,400	-	■	■	■	2 / 1.3-74	

Function	Variant	Type	Flow rate of valve [l/min]	Working port on sub-base		Normal position			→ Page
				G $\frac{3}{8}$	G $\frac{1}{4}$	Closed	Exhausted	Open	
5/3-way valves, monostable	Width 18 mm, pneumatically actuated mid-position valve								
		VSPA-B-P53...A2	650	■	-	■	■	■	2 / 1.3-71
	Width 26 mm, pneumatically actuated mid-position valve								
		VSPA-B-P53...A1	1,400	-	■	■	■	■	2 / 1.3-74

Pneumatic valves, VSPA, ISO 15407-1

Type codes

		VSPA	-	B	-	M	52	-	A	-	A1
Valve family											
VSPA	Standard valves ISO 15 407-1/-2										
Valve type											
B	Sub-base valve										
Valve function											
M	Monostable										
B	Bi-stable										
D	Bi-stable with dominance at 14										
P	Monostable, mid-position										
T	2 monostable valves in one housing										
Connections / switching positions											
32	3/2-way valve										
52	5/2-way valve										
53	5/3-way valve										
Normal position											
C	Closed										
U	Open										
E	Exhausted										
H	Code T with 1x open, 1x closed										
	Bi-stable valve										
Reset method											
A	Pneumatic spring										
M	Mechanical spring										
	Bi-stable valve										
Standard											
A1	ISO size 01, width 26										
A2	ISO size 02, width 18										

Pneumatic valves VSPA, ISO 15407-1

Peripherals overview



Individual mounting

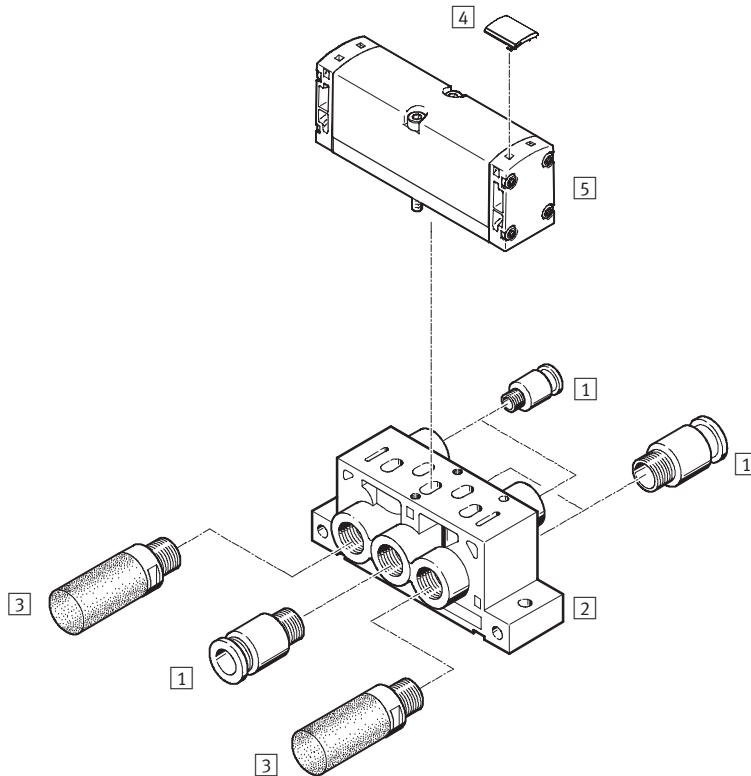

Standard directional control valves
ISO 15407-1

1.3

Accessories				
	Type	Brief description	→ Page	
1	Push-in fitting	QS-...	For connecting compressed air tubing with standard external diameters	
2	Individual sub-base	NAS-...	With lateral ports	2 / 1.3-57
-	Individual sub-base	NAU-...	With ports underneath	-
3	Silencer	U-...	For fitting in exhaust ports	
4	Inscription label holder	ASCF-...	For identifying the valves	2 / 1.3-77
5	Pneumatic valve	VSPA-...	Port pattern to ISO 15407-1	2 / 1.3-71

Port pattern on sub-base to ISO 15407-1

Standard updates given below

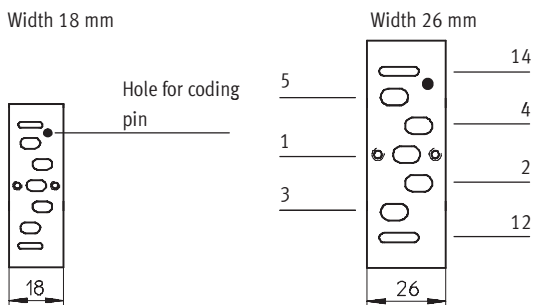

Pneumatic valves VSPA, ISO 15407-1

Peripherals overview

FESTO

Manifold assembly

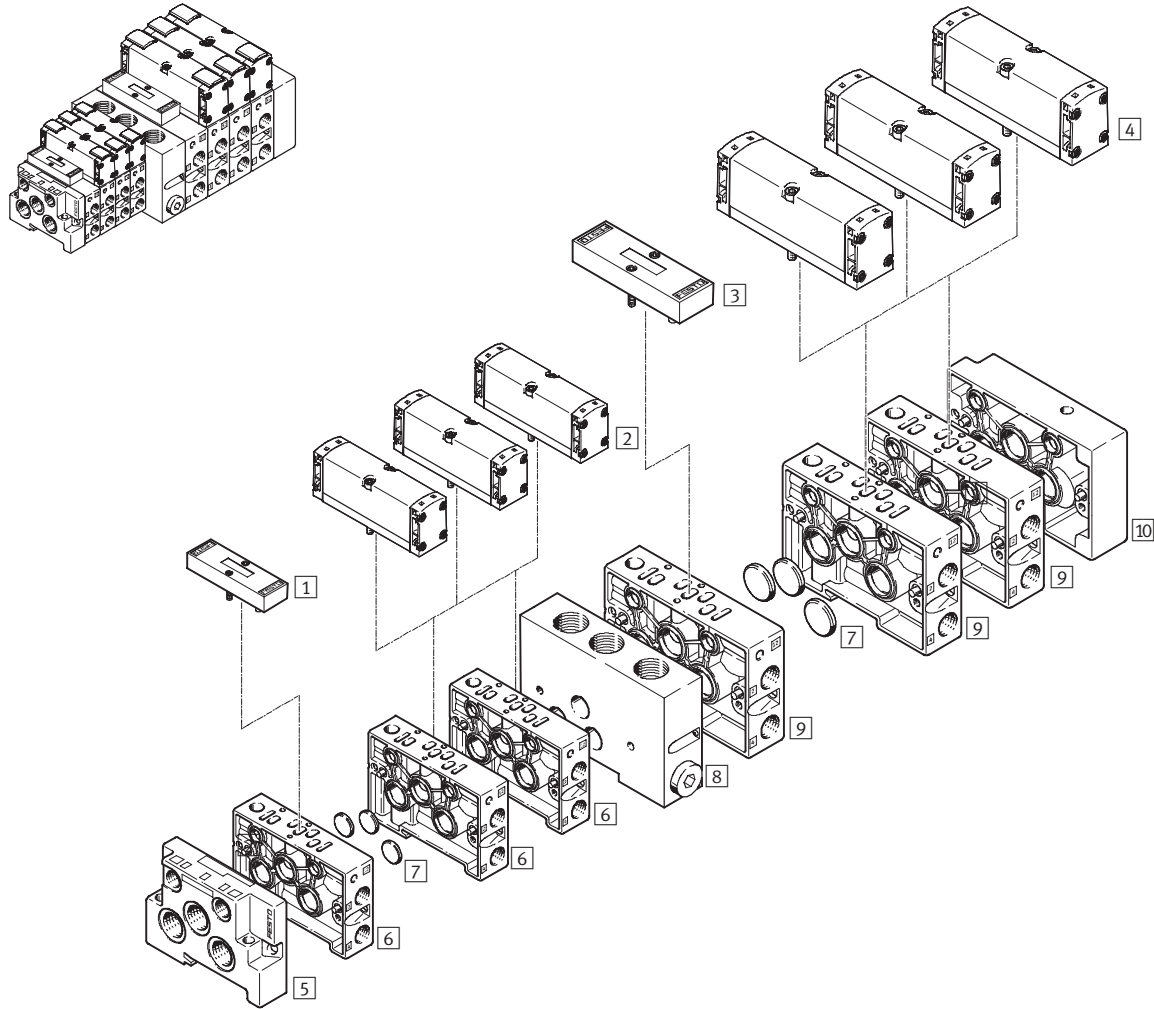

Component parts				
	Type	Brief description	→ Page	
1	Blanking plate	NDV-02-VDMA	For width 18, vacant or spare position	2 / 1.3-65
2	Pneumatic valve	VSPA...A2	Width 18	2 / 1.3-71
3	Blanking plate	NDV-01-VDMA	For width 26, vacant or spare position	2 / 1.3-65
4	Pneumatic valve	VSPA...A1	Width 26	2 / 1.3-74
5	End plate	NEV-...	For sealing the manifold sub-bases width 18	2 / 1.3-58
6	Manifold sub-base	NAW-1/8-02-VDMA	Width 18 with lateral ports 2 and 4	2 / 1.3-58
7	Isolating disc	NSC-...	For creating pressure zones or for sealing ports on the end plates	2 / 1.3-65
8	Intermediate plate	NZV-01/02-VDMA	For connecting width 18 with width 26	2 / 1.3-59
9	Manifold sub-base	NAW-1/4-01-VDMA	Width 26 with lateral ports 2 and 4	2 / 1.3-58
10	End plate	NEV-...	For sealing the manifold sub-bases width 26	2 / 1.3-58

Pneumatic valves VSPA, ISO 15407-1

Peripherals overview



Manifold assembly

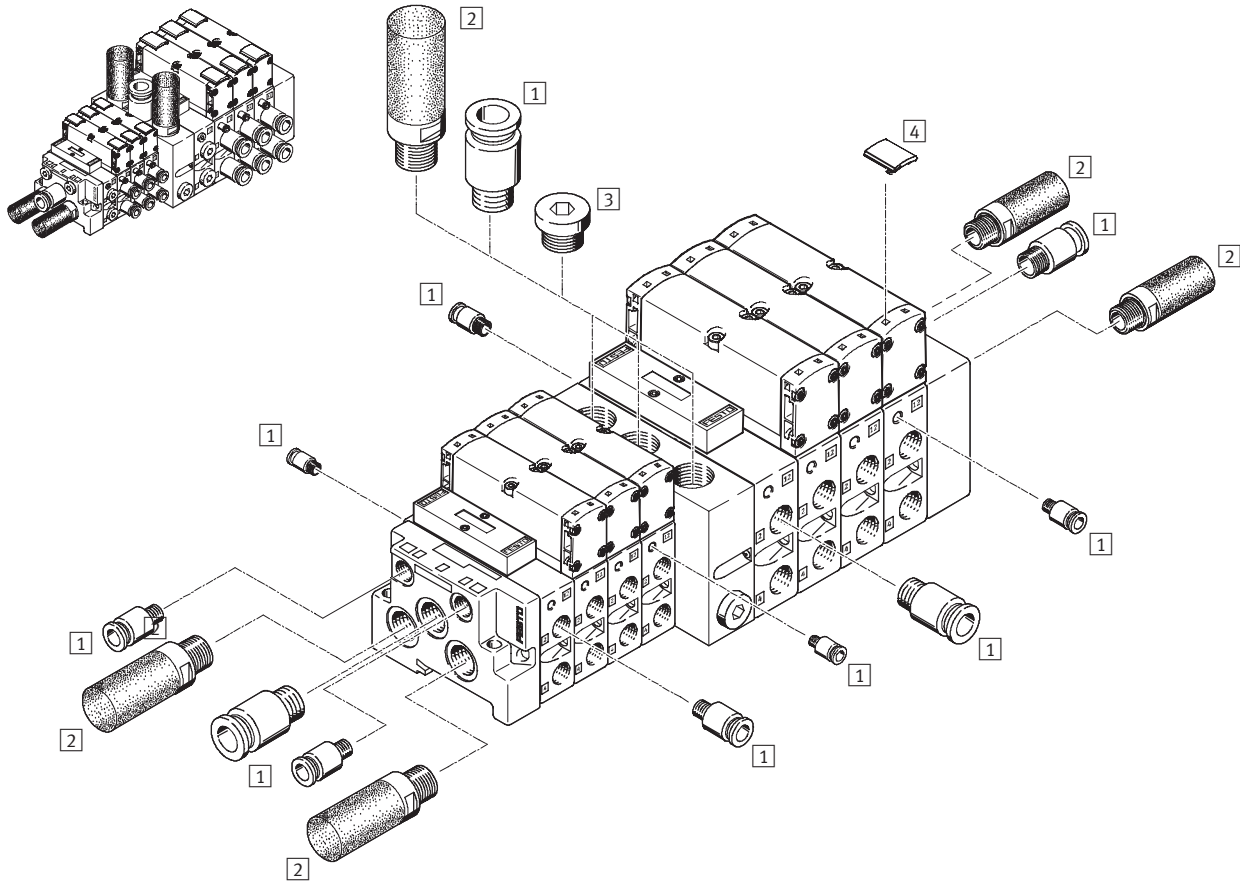

Accessories				
	Type	Brief description	→ Page	
1	Push-in fitting	QS-...	For connecting compressed air tubing with standard external diameters	
2	Silencer	U-...	For fitting in exhaust ports	2 / 1.3-77
3	Blanking plugs	B-...	For fitting in exhaust ports	
4	Inscription label holder	ASCF-...	For identifying the valves	2 / 1.3-77

Pneumatic valves VSPA, ISO 15407-1

Technical data – Directional control valves width 18 mm

 Flow rate
550 ... 750 l/min



General technical data				
Valve function	2x 3/2	5/2	5/3	
Normal position	C ¹⁾ , U ²⁾ , H ⁴⁾	–	–	C ¹⁾ , U ²⁾ , E ³⁾
Memory stability	Monostable	Monostable	Bi-stable	Monostable
Pneumatic spring reset method	Yes	Yes	–	No
Mechanical spring reset method	No	Yes	–	Yes
Design	Piston spool valve			
Sealing principle	Soft			
Actuation type	Pneumatic			
Pilot control mode	Direct			
Direction of flow	Non-reversible	Reversible		
Exhaust function	Flow control			
Type of mounting	On sub-base			
Mounting position	Any			
Nominal diameter [mm]	5			
Flow rate of valve [l/min]	600	750	650	
Flow rate of valve on individual sub-base [l/min]	450	550	500	
Flow rate of valve, pneumatically interlinked [l/min]	400	550	450	
Standard nominal flow rate [l/min]	400	550	450	
Switching time on/off, pneumatic spring [ms]	10/15	11/20	–	–
Switching time on/off, mechanical spring [ms]	–	8/18	–	9/18
Changeover time [ms]	–	–	6	–
Changeover time (dominant) [ms]	–	–	6	–
Width [mm]	18			
Ports on the sub-base	1, 2, 3, 4, 5 12, 14	G1/8 M5		
Tightening torque, valve mounting [Nm]	0.68 ... 0.92			
Product weight [g]	80			
Conforms to	ISO 15407-1			

- 1) C=Normally closed
 2) U=Normally open
 3) E=Normally exhausted
 4) H=2x 3/2-way valve in one housing with 1x normally closed and 1x normally open

Operating and environmental conditions				
Valve function	2x3/2	5/2	5/3	
Operating medium	Filtered compressed air, grade of filtration 40µm, lubricated or unlubricated			
Operating pressure [bar]	2 ... 10	–0.9 ... 10		
Pilot pressure [bar]	2 ... 10	3 ... 10 single solenoid; 2 ... 10 double solenoid	3 ... 10	
Ambient temperature [°C]	–10 ... +60			
Temperature of medium [°C]	–10 ... +60			
Fire protection classification to UL94	HB			

Pneumatic valves, VSPA, ISO 15407-1

Technical data – Directional control valves width 18 mm

Materials

Sectional view

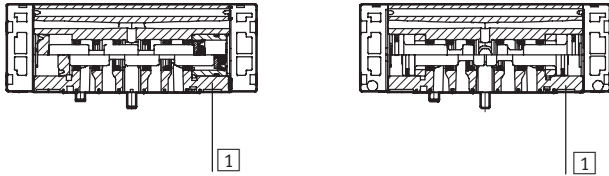

1	Housing	Die-cast aluminium
-	Seals	Nitrile rubber
-	Screws	Galvanised steel

Dimensions

Download CAD data → www.festo.com/en/engineering

Width 18

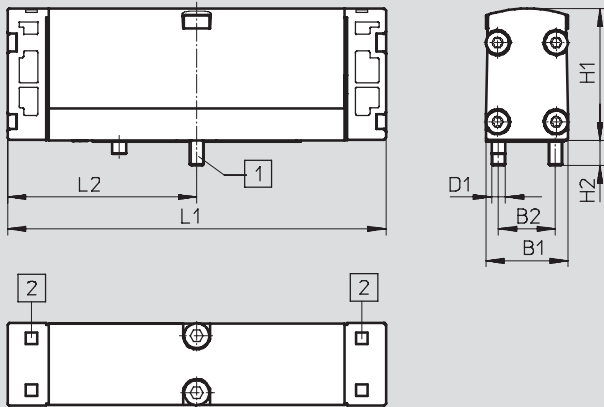

1 Captive screws 2 Slot for inscription label

	B1	B2	D1	H1	H2	L1	L2
VSPA-B-...	18	12.5	M3	29	5.4	83	41.5

Pneumatic valves, VSPA, ISO 15407-1

Technical data – Directional control valves 18

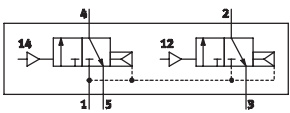
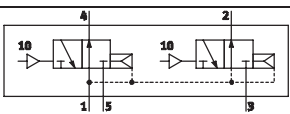
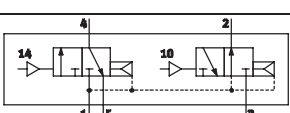
Ordering data – 2x3/2-way valve, width 18				
Code	Circuit symbol	Normal position	Part No.	Type
K		2x closed	546 721	VSPA-B-T32C-A2
N		2x open	546 722	VSPA-B-T32U-A2
H		1x closed 1x open	546 723	VSPA-B-T32H-A2

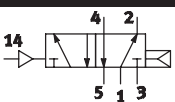
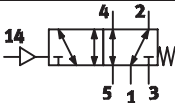
Ordering data – 5/2-way (monostable) valve, width 18				
Code	Circuit symbol	Reset method	Part No.	Type
M		Pneumatic	546 726	VSPA-B-M52-A-A2
O		Mechanical spring	546 727	VSPA-B-M52-M-A2

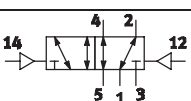
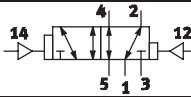
Ordering data – 5/2-way (bi-stable) valve, width 18				
Code	Circuit symbol	Dominant	Part No.	Type
J		1st signal	546 724	VSPA-B-B52-A2
D		At 14	546 725	VSPA-B-D52-A2

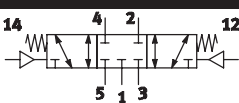
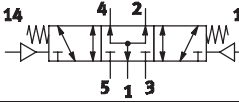
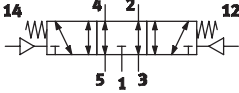
Ordering data – 5/3-way (monostable) valve, width 18				
Code	Circuit symbol	Normal position	Part No.	Type
G		Closed	546 730	VSPA-B-P53C-A2
B		Open	546 728	VSPA-B-P53U-A2
E		Exhausted	546 729	VSPA-B-P53E-A2

Pneumatic valves VSPA, ISO 15407-1

Technical data – Directional control valves width 26 mm

-  - Flow rate
1,250 ... 1,400 l/min



General technical data				
Valve function	2x 3/2	5/2	5/3	
Normal position	C ¹⁾ , U ²⁾ , H ⁴⁾	–	–	C ¹⁾ , U ²⁾ , E ³⁾
Memory stability	Monostable	Monostable	Bistable	Monostable
Pneumatic spring reset method	Yes	Yes	–	No
Mechanical spring reset method	No	Yes	–	Yes
Design	Piston spool valve			
Sealing principle	Soft			
Actuation type	Pneumatic			
Pilot control mode	Direct			
Direction of flow	Non-reversible	Reversible		
Exhaust function	Flow control			
Type of mounting	On sub-base			
Mounting position	Any			
Nominal diameter [mm]	9			
Flow rate of valve [l/min]	1,250	1,400	1,400	
Flow rate of valve on individual sub-base [l/min]	1,000	1,100	1,100	
Flow rate of valve, pneumatically interlinked [l/min]	900	1,100	1,000	
Standard nominal flow rate [l/min]	900	1,100	1,000	
Switching time on/off, pneumatic spring [ms]	15/28	18/30	–	–
Switching time on/off, mechanical spring [ms]	–	10/35	–	13/32
Changeover time [ms]	–	–	10	–
Changeover time (dominant) [ms]	–	–	10	–
Width [mm]	26			
Ports on the sub-base	1, 2, 3, 4, 5	G ¹ / ₄		
	12, 14	M5		
Tightening torque, valve mounting [Nm]	1.62 ... 2.18			
Product weight [g]	180			
Conforms to	ISO 15407-1			

- 1) C=Normally closed
 2) U=Normally open
 3) E=Normally exhausted
 4) H=2x 3/2-way valve in one housing with 1x normally closed and 1x normally open

Operating and environmental conditions			
Valve function	2x3/2	5/2	5/3
Operating medium	Filtered compressed air, grade of filtration 40µm, lubricated or unlubricated		
Operating pressure [bar]	2 ... 10	–0.9 ... 10	–0.9 ... 10
Pilot pressure [bar]	2 ... 10	2 ... 10 double solenoid; 3 ... 10 single solenoid	3 ... 10
Ambient temperature [°C]	–10 ... +60		
Temperature of medium [°C]	–10 ... +60		
Fire protection classification to UL94	HB		

Pneumatic valves, VSPA, ISO 15407-1

Technical data – Directional control valves width 26 mm

Materials

Sectional view

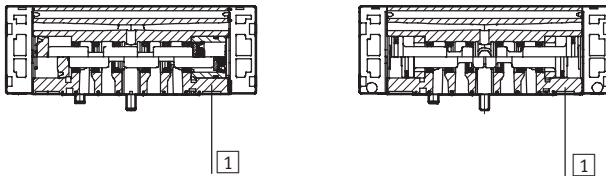

1	Housing	Die-cast aluminium
-	Seals	Nitrile rubber
-	Screws	Galvanised steel

Dimensions

Download CAD data → www.festo.com/en/engineering

Width 18

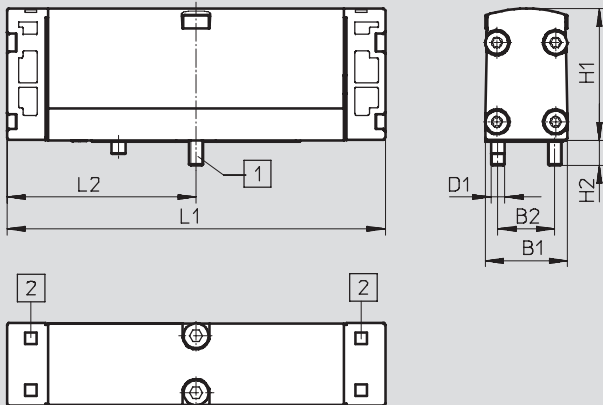

1 Captive screws 2 Slot for inscription label

	B1	B2	D1	H1	H2	L1	L2
VSPA-B-...	26.2	19	M4	38	7	100	50

Pneumatic valves, VSPA, ISO 15407-1

Technical data – Directional control valves width 26 mm

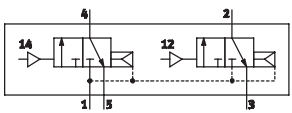
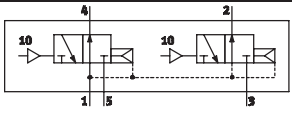
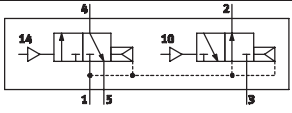
Ordering data – 2x3/2-way valve, width 26				
Code	Circuit symbol	Normal position	Part No.	Type
K		2x closed	546 711	VSPA-B-T32C-A1
N		2x open	546 712	VSPA-B-T32U-A1
H		1x closed 1x open	546 713	VSPA-B-T32H-A1

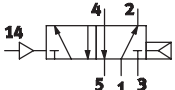
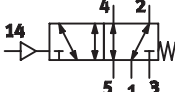
Ordering data – 5/2-way valve (monostable), width 26				
Code	Circuit symbol	Reset method	Part No.	Type
M		Pneumatic	546 716	VSPA-B-M52-A-A1
O		Mechanical spring	546 717	VSPA-B-M52-M-A1

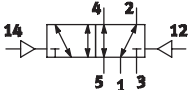
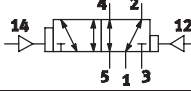

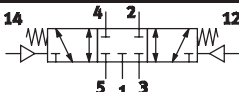
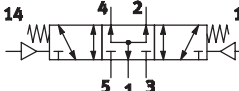
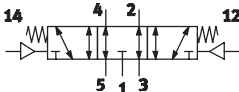



Ordering data – 5/2-way (bi-stable) valve, width 26				
Code	Circuit symbol	Dominant	Part No.	Type
J		1st signal	546 714	VSPA-B-B52-A1
D		At 14	546 715	VSPA-B-D52-A1



Ordering data – 5/3-way (monostable) valve, width 26				
Code	Circuit symbol	Normal position	Part No.	Type
G		Closed	546 720	VSPA-B-P53C-A1
B		Open	546 718	VSPA-B-P53U-A1
E		Exhausted	546 719	VSPA-B-P53E-A1

Solenoid/pneumatic valves, ISO 15407-1

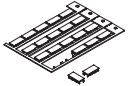
FESTO

Accessories

Ordering data			
		Part No.	Type
Pressure gauge		Technical data → Volume 3	
	With cartridge connection for regulator, 10 bar	543 487	PAGN-26-16-P10
	With cartridge connection for regulator, 6 bar	543 488	PAGN-26-10-P10
Cartridge for regulator plate			
	For tubing O.D. 4 mm	172 972	QSP10-4
	For tubing O.D. 3/16	172 975	QSP10-3/16U
Blanking plugs		Technical data → Volume 3	
	Pack of 10	3570	B-3/8
Silencer			
	For connection 12	6841	U-1/8-B
	For connection 3 and 5 at width 18 mm	6843	U-3/8-B
	For connection 3 and 5 at width 26 mm	6844	U-1/2-B
Inscription label			
	Inscription label for valves VSVA (24 in frames included in scope of delivery)	18 182	IBS-9x20
Inscription label holder			
	Clip-on inscription label holder for valve cap (pack of 5)	540 888	ASCF-T-S6

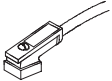
Ordering data – Plug sockets, plug sockets with cable for plug pattern DIN EN 175301-803, type C					
	Voltage [V]	Cable length [m]	Switching status display with LED	Part No.	Type
Plug socket without cable					Technical data → 2 / 7.2-12
	–	–	–	151 687	MSSD-EB
	–	–	–	539 712	MSSD-EB-M12
Plug socket without cable with insulation displacement technology					Technical data → 2 / 7.2-12
	–	–	–	192 745	MSSD-EB-S-M14
Plug socket with cable					Technical data → 2 / 7.3-27
	24 DC	2.5	■	151 688	KMEB-1-24-2,5-LED
	24 DC	5	■	151 689	KMEB-1-24-5-LED
	24 DC	10	■	193 457	KMEB-1-24-10-LED
	to 240	2.5	–	151 690	KMEB-1-230AC-2,5
	to 240	5	–	151 691	KMEB-1-230AC-5
	24 DC	2.5	■	174 844	KMEB-2-24-2,5-LED
	24 DC	5	■	174 845	KMEB-2-24-5-LED
	to 240	2.5	–	174 846	KMEB-2-230-2,5
	to 240	5	–	174 847	KMEB-2-230-5

Standard directional control valves
ISO 15407-1

1.3

Solenoid/pneumatic valves, ISO 15407-1



Accessories



FESTO



Standard directional control valves
ISO 15407-1

1.3

Ordering data – Illuminating seal for plug pattern DIN EN 175301-803, type C				Technical data → 2 / 7.4-1	
	Voltage		Part No.	Type	
	[V DC]	[V AC]			
	12 ... 24	–	151 717	MEB-LD-12-24DC	
	–	230	151 718	MEB-LD-230AC	

Ordering data – Plug sockets, plug sockets with cable for valves with central plug M12x1				Technical data → 2 / 7.2-12		
	Voltage		Cable length [m]	Part No.	Type	
	[V DC]	[V AC]				
Plug socket without cable						
	–	–	–	185 498	SEA-M12-4WD-PG7	
Plug socket with cable						
	–	–	1	185 499	KM-12-M12-GSWD-1-4	

Ordering data – Plug sockets with cable M12x1 for VSVA valves						Technical data → Volume 4		
	Mounting	Connection	Switch output		Cable length [m]	Part No.	Type	
			PNP	NPN				
Straight plug socket								
	Knurled ring M12x1	4-pin	■	■	5	164 259	SIM-M12-4GD-5-PU	
Angled plug socket								
	Knurled ring M12x1	4-pin	■	■	5	164 258	SIM-M12-4WD-5-PU	

Ordering data – Plug sockets with cable M8x1 for VSVA valves						Technical data → Volume 4		
	Mounting	Connection	Switch output		Cable length [m]	Part No.	Type	
			PNP	NPN				
Straight plug socket								
	Knurled ring M8x1	4-pin	■	■	2.5	158 960	SIM-M8-4GD-2,5-PU	
					5	158 961	SIM-M8-4GD-5-PU	
Angled plug socket								
	Knurled ring M8x1	4-pin	■	■	2.5	158 962	SIM-M8-4WD-2,5-PU	
					5	158 963	SIM-M8-4WD-5-PU	

Valve terminal type 16 VTIA – Electrical part

Ordering data – Modular products

M Mandatory data				O Options	
Module No.	Valve terminal, electrical part	Electrical connection	Voltage	Connecting cable	User's manual
546 835	16E	ZSR8 ZSR12	24DC	GA, GB, GD, GE	D, E, F, I, S
Order example					
546 835	16E	-	24DC	+	-
1	2	3	4	5	6

Ordering table				Condi- tions	Code	Enter code
M	1	Module No.	546 835			
	2	Valve terminal, electrical part	Valve terminal type 16, VTIA		16E	16E
	3	Electrical connection	Central plug M8		-ZSR8	
			Central plug M12		-ZSR12	
	4	Voltage	24 V DC		-24DC	-24DC
O	5	Electrical accessories			+	+
		Connecting cable	2.5 m, round plug socket, straight	1	GA	
			5 m, round plug socket, straight		GB	
			2.5 m, round plug socket, angled	1	GD	
			5 m, round plug socket, angled		GE	
	6	User's manual	German		-D	
			English		-E	
			French		-F	
			Italian		-I	
			Spanish		-S	

1 GA Only with electrical connection (3) ZSR8

Valve terminal type 16 VTIA – Electrical part

Ordering data – Modular products

M Mandatory data				O Options	
Module No.	Valve terminal, electrical part	Electrical connection	Voltage	Connecting cable	User's manual
546 835	16E	DINC	12DC, 24DC, 24AC, 110AC, 230AC	GG, GH, GJ, GK, GL	D, E, F, I, S
Order example					
546 835	16E	- DINC	-	+ 	-
1	2	3	4	5	6

Ordering table				Condi- tions	Code	Enter code	
M	1	Module No.	546 835				
	2	Valve terminal, electrical part	Valve terminal type 16, VTIA		16E	16E	
	3	Electrical connection	Pilot interface ISO 15218		-DINC	-DINC	
	4	Voltage	12 V DC		-12DC		
			24 V DC		-24DC		
			24 V AC		-24AC		
			110 V AC		-110AC		
			230 V AC		-230AC		
O	5	Electrical accessories			+	+	
	5	Connecting cable	Polyurethane	2.5 m, plug socket with cable, EN 175301 type C, LED	¹	GG	
				5 m, plug socket with cable, EN 175301 type C, LED	¹	GH	
				10 m, plug socket with cable, EN 175301 type C, LED	¹	GJ	
		Polyvinyl chloride	2.5 m, plug socket with cable, EN 175301 type C, up to 230 V AC		GK		
			5 m, plug socket with cable, EN 175301 type C, up to 230 V AC		GL		
	6	User's manual	German		-D		
			English		-E		
			French		-F		
			Italian		-I		
			Spanish		-S		

¹ **GG, GH, GJ** Not with electrical connection (3) 24AC, 110AC, 230AC

Valve terminal type 16 VTIA – Pneumatic part

Ordering data – Modular products

M Mandatory data →

Module No.	Valve terminal, pneumatic part	Manual override	Pilot air supply	Type of connection
546 835	16P	N, T	P, S	G
Order example				
546 835				G
1	2	3	4	5

Ordering table		18 mm	26 mm	Condi- tions	Code	Enter code
M	1 Module No.	546 835				
	2 Valve terminal, pneumatic part	Valve terminal type 16, VTIA, modular sub-base valves to ISO 15407-1			16P	16P
	3 Manual override	Pushing (non-detenting)			-N	
		Pushing, detenting with tool		1	-T	
	4 Pilot air supply	Internal pilot air supply			-P	
		External pilot air supply			-S	
↓	5 Type of connection	G thread (standard)			-G	-G

1 T Only with electrical connection DINC (pilot interface ISO 15218)

Valve terminal type 16 VTIA – Pneumatic part

Ordering data – Modular products

→ 0 Options		M	0	M	0		→
Pneumatic supply to valve terminal	Pneumatic supply connection position	Configuration of pneumatic connections	Exhaust position	Additional supply/removal	Reverse operation		
S, V	TL, TR, TB	M, N, G	EL, ER, EB	E	Z		
6	7	8	9	10	11		

Ordering table						
Width	18 mm	26 mm	Condi- tions	Code	Enter code	
				-	-	
0 6	Pneumatic supply to valve terminal	Silencer and QS push-in fittings	2	S		
		QS push-in fittings	2	V		
M 7	Pneumatic supply connection position	Left		TL		
		Right		TR		
		At both sides		TB		
0 8	Configuration of pneumatic connections	QS push-in fittings, large	3	M		
		QS push-in fittings, small	3	N		
		QS push-in fittings, large and small mixed	3	G		
M 9	Exhaust position	Left		EL		
		Right		ER		
		At both sides		EB		
0 10	Additional supply/removal	Supply to adapter plate		-E		
↓ 11	Reverse operation	Reverse operation as of valve position 00		-Z		

2 S, V Only with configuration of pneumatic connections (8) M, N, G

3 M, N, G Only with pneumatic valve terminal supply (6) S, V.

Sizes of pneumatic connections → Table on page 2 / 1.3-86

Valve terminal type 16 VTIA – Pneumatic part

Ordering data – Modular products

M Mandatory data
Pneumatic manifold sub-bases 00 ... 15
12 Type of manifold sub-base: A, B, AK, BK

O Options
13 Compressed air supply/duct separation: S, T, R, V, SV, VS, TV, VT, RV, VR

14 Reverse operation: Z

Module position

00 01 02 03 04 05 06 07 08 09 10 11 12 13 14 15

12 + 13 + 14

Ordering table		18 mm	26 mm	Condi- tions	Code	Enter code
M	Pneumatic manifold sub-bases			[4]	-	-
12	Type of sub-base 00 ... 15	Manifold sub-base 1/8	-	[5] [6]	A	Enter the equip- ment selected in the order code
		-	Manifold sub-base 1/4	[6]	B	
		Manifold sub-base with QS push-in fittings, small	-	[5] [7]	AK	
		-	Manifold sub-base with QS push-in fittings, small	[7]	BK	
13	Adapter plate for changing size/duct separation 00 ... 14	Duct separation 1, 3, 5		[8] [9]	S	
		Duct separation 1		[8] [10]	T	
		Duct separation 3, 5		[8] [11]	R	
		Adapter plate		[12]	V	
		Adapter plate with duct separation 1, 3, 5 at left		[8] [9] [12]	SV	
		Adapter plate with duct separation 1, 3, 5 at right		[8] [9] [12]	VS	
		Adapter plate with duct separation 1 at left		[8] [10] [12]	TV	
		Adapter plate with duct separation 1 at right		[8] [10] [12]	VT	
		Adapter plate with duct separation 3, 5 at left		[8] [11] [12]	RV	
Adapter plate with duct separation 3, 5 at right		[8] [11] [12]	VR			
14	Reverse operation 00 ... 15	Subsequent valve positions permitted for reverse operation		[13]	Z	

[4] Manifold sub-bases must be equipped throughout without any gaps

[5] **A, AK** Not permitted if B, BK, was previously selected in the sequence.

Note direction of change in size

[6] **A, B** Not with configuration of pneumatic connections (8) N

[7] **AK, BK** Not with configuration of pneumatic connections (8) M

[8] **S, T, R, SV, VS, TV, VT, RV, VR**

No pressure-free zones may be created.

Adapter plate only permitted once

[9] **S, SV, VS** With duct separation S... without a combination of sizes, supply and exhaust at both sides is required.

With duct separation S... with a combination of sizes and without supply to the adapter plate, supply and exhaust at both sides is required

[10] **T, TV, VT** With duct separation T... without a combination of sizes, supply at both sides is required.

With duct separation T... with a combination of sizes and without supply to the adapter plate, supply at both sides is required

[11] **R, RV, VR** With duct separation R... without a combination of sizes, exhaust at both sides is required.

With duct separation R... with a combination of sizes and without supply to the adapter plate, exhaust at both sides is required

[12] **V, SV, VS, TV, VT, RV, VR**

Must be selected if additional supply/removal (10) E was selected.

At least one subsequent manifold sub-base (12) B or BK must be selected

Only directly after adapter plate for changing size/duct separation (13) S, SV,

VS (duct separation 1, 3, 5) and pneumatic supply connection position (7) TB

(supply at both sides), exhaust position (9) EB (exhaust at both sides)

or after adapter plate for changing size/duct separation (13) SV (adapter

plate with duct separation 1, 3, 5 at left) and additional supply/removal (10)

E (supply to adapter plate) with pneumatic supply connection position (7) TL

(supply at left) and exhaust position (9) EL (exhaust at left)

or directly after adapter plate for changing size/duct separation (13) VS

(adapter plate with duct separation 1, 3, 5 at right) and additional supply/

removal (10) E (supply to adapter plate) with pneumatic supply connection

position (7) TR (supply at right) and exhaust position (9) ER (exhaust at right).

Not with pilot air supply (4) P (internal pilot air supply)

[13] **Z**

Valve terminal type 16 VTIA – Pneumatic part

Ordering data – Modular products



→ **M** **O** Options →

Pneumatic valve positions 00 ... 15

15 Valve position 00 ... 15: M, O, J, D, N, K, H, B, G, E, L

O Options

16 Pressure regulator for position 00 ... 15: ZA, ZB, ZC, ZD, ZE, ZF, ZG, ZH, ZI, ZJ, ZK, ZL, ZM, ZN

17 Pressure gauge for position 00 ... 15: T, U

18 Flow control plate 00 ... 15: X

19 Vertical pressure shut-off plate for position 00 ... 15: ZT

Valve position 20 Vertical supply plate for position 00 ... 151: ZU

00	01	02	03	04	05	06	07	08	09	10	11	12	13	14	15
M	M	M	O	O	O	J	J	E	E						

15 + 16 + 17 + 18 + 19 + 20

Ordering table

Width	18 mm	26 mm	Condi- tions	Code	Enter code				
↓	Pneumatic valve positions 00 ... 15			-	-				
M 15	Valve position 00 ... 15		5/2-way valve, single solenoid with pneumatic spring return		M	Enter equip- ment selection for valve posi- tions in order code			
			5/2-way valve, single solenoid with spring return		O				
			5/2-way valve, double solenoid		J				
			5/2-way valve, double solenoid with dominant signal		D				
			2x 3/2-way valve, normally open		N				
			2x 3/2-way valve, normally closed		K				
			2x 3/2-way valve, 1x normally closed, 1x normally open		H				
			5/3-way valve, mid-position pressurised		B				
			5/3-way valve, mid-position closed		G				
			5/3-way valve, mid-position exhausted		E				
			Vacant position		L				
			O 16	Pressure regulator for valve position 00 ... 15	Input pressure 10 bar		Pressure regulator plate for port 1	¹⁴	ZA
							Pressure regulator plate for port 4		ZB
	Pressure regulator plate for port 2				ZC				
	Pressure regulator plate for port 4/2				ZD				
	Pressure regulator plate for port 4/2, reversible	¹⁴ ¹⁵			ZE				
	Pressure regulator plate for port 4, reversible	¹⁴ ¹⁵			ZK				
	Pressure regulator plate for port 2, reversible	¹⁴ ¹⁵			ZL				
Input pressure 6 bar	Pressure regulator plate for port 1	¹⁴			ZF				
	Pressure regulator plate for port 4				ZG				
	Pressure regulator plate for port 2				ZH				
	Pressure regulator plate for port 4/2				ZI				
	Pressure regulator plate for port 4/2, reversible	¹⁴ ¹⁵			ZJ				
	Pressure regulator plate for port 4, reversible	¹⁴ ¹⁵			ZM				
	Pressure regulator plate for port 2, reversible	¹⁴ ¹⁵			ZN				

¹⁴ ZA, ZE, ZK, ZL, ZF, ZJ, ZM, ZN

Not permitted in zones with reverse operation

¹⁵ ZE, ZK, ZL, ZJ, ZM, ZN

Not with valves (15) N, K, H (2x 3/2-way valve)

Valve terminal type 16 VTIA – Pneumatic part

Ordering data – Modular products

→ **Options**

Pneumatic accessories

...B

+ **21**

Ordering table						
Width	18 mm	26 mm	Condi- tions	Code	Enter code	
↓ <input type="checkbox"/>	17 Pressure gauge for valve position 00 ... 15	Pressure gauge, 10 bar	<input type="checkbox"/> 16	T	Enter equipment selection for valve positions in order code	
		Pressure gauge, 6 bar	<input type="checkbox"/> 17	U		
18 Flow control plate for valve position 00 ... 15	Flow control plate			X		
19 Vertical pressure shut-off plate for valve position 00 ... 15	Pressure separator plate on valve assembly			ZT		
20 Vertical supply plate for valve position 00 ... 15	Compressed-air supply on valve			ZU		
21	Pneumatic accessories			+	+	
	Inscription label holder for valves	5 ... 50	<input type="checkbox"/> 18	...B		

T Only with pressure regulator (16) ZA, ZB, ZC, ZD, ZE, ZK, ZL
 U Only with pressure regulator (16) ZF, ZG, ZH, ZI, ZJ, ZM, ZN

B Only with electrical connection ZSR8, ZSR12

Valve terminal type 16 VTIA – Pneumatic part

Ordering data – Modular products

Sizes of pneumatic connections					
	Code	Duct	Width		
			18 mm	26 mm	
8		Configuration of pneumatic connections			
7	Pneumatic supply connection position TL, TR, TB	M	1, 3, 5	G $\frac{1}{2}$ (QS-G $\frac{1}{2}$ -16)	G $\frac{1}{2}$ (QS-G $\frac{1}{2}$ -16)
		G	1, 3, 5	G $\frac{1}{2}$ (QS-G $\frac{1}{2}$ -16)	G $\frac{1}{2}$ (QS-G $\frac{1}{2}$ -16)
		N	1, 3, 5	G $\frac{1}{2}$ (QS-G $\frac{1}{2}$ -12)	G $\frac{1}{2}$ (QS-G $\frac{1}{2}$ -12)
9	Exhaust position EL, ER, EB	M	12, 14	G $\frac{1}{4}$ (QS-G $\frac{1}{4}$ -10)	G $\frac{1}{4}$ (QS-G $\frac{1}{4}$ -10)
		G	12, 14	G $\frac{1}{4}$ (QS-G $\frac{1}{4}$ -10)	G $\frac{1}{4}$ (QS-G $\frac{1}{4}$ -10)
		N	12, 14	G $\frac{1}{4}$ (QS-G $\frac{1}{4}$ -8)	G $\frac{1}{4}$ (QS-G $\frac{1}{4}$ -8)
12	Type of manifold sub-base A, B	M	2, 4	G $\frac{1}{8}$ (QS-G $\frac{1}{8}$ -8)	G $\frac{1}{4}$ (QS-G $\frac{1}{4}$ -10)
12	Type of manifold sub-base AK, BK	N	2, 4	G $\frac{1}{8}$ (QS-G $\frac{1}{8}$ -6)	G $\frac{1}{4}$ (QS-G $\frac{1}{4}$ -8)