

Inscription labels

Technical data

Inscription labels for labelling, can be used in holders or carriers on suitably equipped components.

Inscription labels are arranged in a press-out frame, several of which are combined to form a delivery unit.

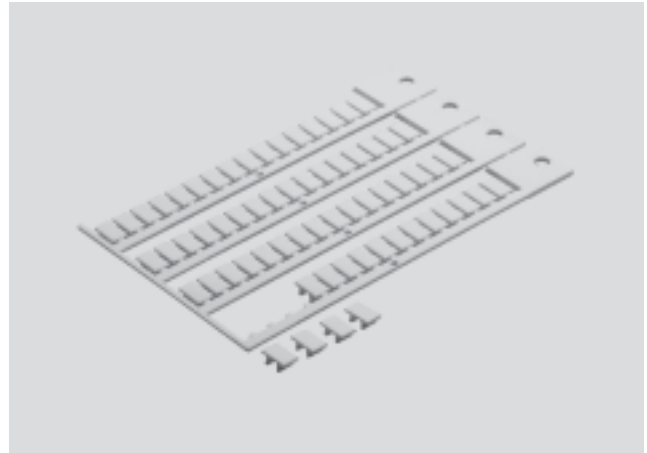

General technical data	
Type of mounting	Pressed into inscription label holders or suitable carriers on the components
Corrosion resistance class CRC ¹⁾	2

1) Corrosion resistance class 2 according to Festo standard 940 070

Components requiring moderate corrosion resistance. Externally visible parts with primarily decorative surface requirements which are in direct contact with a surrounding industrial atmosphere or media such as cooling or lubricating agents.

Ordering data						
View	Inscription	Material	Number per frame	Dimensions (HxW)	Part No.	Type
				[mm]		
	Numbers 1...50	Polyvinyl chloride, soft	50	5.5x4.9	6 888	BZ-NUM 1-50
	Numbers 51...100		50	5.5x4.9	6 889	BZ-NUM 51-100
	By user	Polycarbonate (Lexan 920)	64	6x10	18 576	IBS-6x10
			24	9x17	161 937	IBS-9x17
		Polycarbonate (Lexan 920)	20	8x20	539 388	IBS-8x20
			20	9x20	18 182	IBS-9x20
			30	10x17	160 238	IBS-10x17
		Polyamide	35	11x17x8	33 362	KMC/F/V-BZ-35X
		Polycarbonate (Lexan)	80	4.5x9	197 259	MH-BZ-80X

Inscription labels

Technical data – Inscription clips

FESTO

Inscription clips for placing on a cable.

Inscription clips for cables can be applied to any cable according to the maximum diameter. Many pre-assembled cables already have a labelling option on the connection point (socket/plug).



General technical data	
Type	KM-BZ
Part No.	33 361
Type of mounting	Inscription clip is pressed onto a cable
Inscription	By user. The inscription label itself is not labelled. The inscription is made on an insertable label or paper/cardboard strip.
Cable diameter [mm]	5 ... 8
Corrosion resistance class CRC ¹⁾	2

1) Corrosion resistance class 2 according to Festo standard 940 070

Components requiring moderate corrosion resistance. Externally visible parts with primarily decorative surface requirements which are in direct contact with a surrounding industrial atmosphere or media such as cooling or lubricating agents.

Inscription labels

Technical data – Inscription label holders

Inscription label holders enable inscription labels to be attached to components without pre-assembled carriers, or with special carriers for holders of this type.

If display components are concealed by the inscription label holder, the carrier is either transparent at these points or completely transparent.

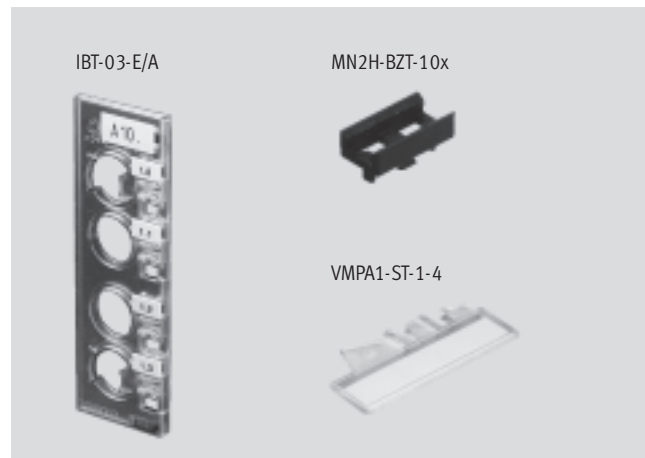

Inscription system

Inscription label holders enable inscription labels to be attached when there are no suitable holders on the component itself.

They can either be equipped with inscription labels or are designed to hold inscribed paper/cardboard or foil strips.

Due to their size, inscription label holders conceal part of the module to which they are attached. Depending on the type of inscription label holder, the display components either remain visible through a transparent surface or the carrier itself acts as a suitable cover.



Note

The Word templates for inscription label holders/identification strips can be found at:

→ www.festo.com

Inscription labels

Technical data – Inscription label holders

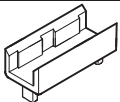
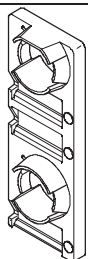
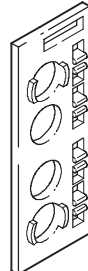
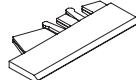
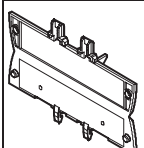
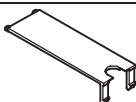
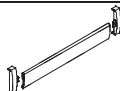
Ordering data							
View	Holders for inscription labels	Product weight [g]	Material	For module with the following number of valves	Type of mounting	Part No.	Type
	1 (9x17)	7	Polyamide	–	Pushed into carriers on the components	161 936	MN2H-BZT-10X
	1 (9x17)	19	Polyamide 6 (Miramid)	–		18 575	MVH-BZ
	3 (9x20)	47	Polycarbonate (Makrolon 2405), transparent	–	Placed on component	158 968	IBT-02-E/A
	1 (9x20) 8 (6x10)	38	Polycarbonate (Makrolon 2405), transparent	–	Placed on component	18 183	IBT-03-E/A
	Insertable label or paper/cardboard strips	6	Polypropylene (Novolen 3300 MC), transparent	–	Pushed into carriers on the components	533 362	VMPA1-ST-1-4
	Insertable label or paper/cardboard strips	5	Polypropylen (Moplen RP220M), transparent	–	Pushed into carriers on the components	536 593	CPX-ST-1
	Insertable label or paper/cardboard strips	2	Polyamide PACM12 (Trogamid), transparent	–	Pushed into carriers on the components	658 807	MPA
	Insertable label or paper/cardboard strips	7	Polyvinyl chloride (RAU-PVC 1107)	4	Pushed into carriers on the components	527 631	CPVSC1-ST-4
		9		8		527 633	CPVSC1-ST-8
		15		12		527 635	CPVSC1-ST-12
		20		16		527 637	CPVSC1-ST-16

Inscription labels

Technical data – Inscription label holders

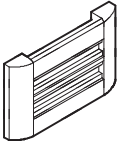
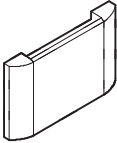
Ordering data							
View	Holders for inscription labels	Product weight [g]	Material	For module with the following number of valves	Type of mounting	Part No.	Type
	4 (6x10)	9	Polyvinyl chloride, hard	2	Pushed into carriers on the components	162 560	CPV10-VI-BZT-2
	6 (6x10)	10		3		162 561	CPV10-VI-BZT-3
	8 (6x10)	11		4		162 562	CPV10-VI-BZT-4
	10 (6x10)	15		5		162 563	CPV10-VI-BZT-5
	12 (6x10)	14		6		162 564	CPV10-VI-BZT-6
	14 (6x10)	15		7		162 565	CPV10-VI-BZT-7
	16 (6x10)	16		8		162 566	CPV10-VI-BZT-8
	4 (6x10)	10		2		162 567	CPV14-VI-BZT-2
	6 (6x10)	11		3		162 568	CPV14-VI-BZT-3
	8 (6x10)	13		4		162 569	CPV14-VI-BZT-4
	10 (6x10)	15		5		162 570	CPV14-VI-BZT-5
	12 (6x10)	16		6		162 571	CPV14-VI-BZT-6
	14 (6x10)	19		7		162 572	CPV14-VI-BZT-7
	16 (6x10)	21		8		162 573	CPV14-VI-BZT-8
	4 (6x10)	11		2		163 293	CPV18-VI-BZT-2
	6 (6x10)	12		3		163 294	CPV18-VI-BZT-3
	8 (6x10)	17		4		163 295	CPV18-VI-BZT-4
	10 (6x10)	18		5		163 296	CPV18-VI-BZT-5
	12 (6x10)	20		6		163 297	CPV18-VI-BZT-6
	14 (6x10)	23		7		163 298	CPV18-VI-BZT-7
16 (6x10)	29	8	163 299	CPV18-VI-BZT-8			
	Insertable label or paper/cardboard strips	8	2	194 066	CPV10-VI-ST-2		
		10	3	194 067	CPV10-VI-ST-3		
		11	4	194 068	CPV10-VI-ST-4		
		13	5	194 069	CPV10-VI-ST-5		
		14	6	194 070	CPV10-VI-ST-6		
		15	7	194 071	CPV10-VI-ST-7		
		16	8	194 072	CPV10-VI-ST-8		
		10	2	194 073	CPV14-VI-ST-2		
		11	3	194 074	CPV14-VI-ST-3		
		14	4	194 075	CPV14-VI-ST-4		
		15	5	194 076	CPV14-VI-ST-5		
		20	6	194 077	CPV14-VI-ST-6		
		19	7	194 078	CPV14-VI-ST-7		
		22	8	194 079	CPV14-VI-ST-8		
		11	2	194 080	CPV18-VI-ST-2		
		13	3	194 081	CPV18-VI-ST-3		
		15	4	194 082	CPV18-VI-ST-4		
		18	5	194 083	CPV18-VI-ST-5		
		21	6	194 084	CPV18-VI-ST-6		
		23	7	194 085	CPV18-VI-ST-7		
	28	8	194 086	CPV18-VI-ST-8			

Inscription labels

Technical data – Inscription label holders

Examples illustrating the attachment of inscription label holders

CPV10-VI...

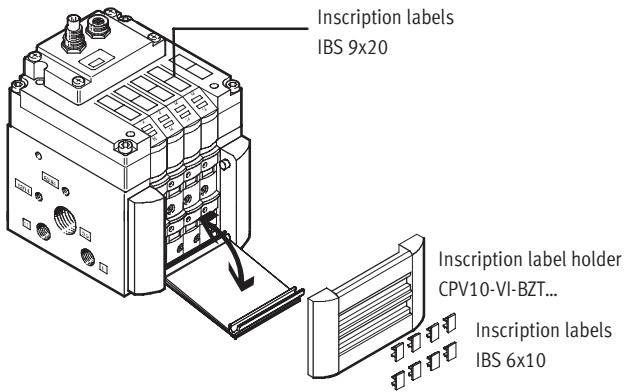

- The inscription label holder is locked into recesses on the valve terminal
- The inscription is created using inscription labels or by inserting identification strips

 Note

The inscription label holder cannot be used together with relay slices.

CPVSC1-ST...

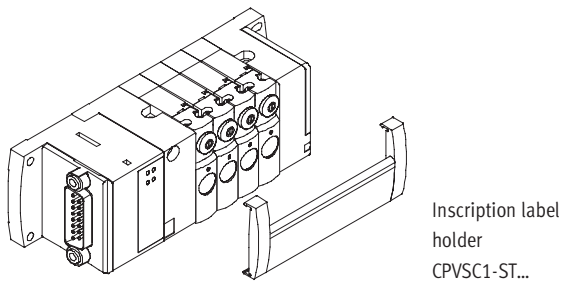

- The inscription label holder is clipped onto the valve terminal
- The inscription is created by inserting identification strips

IBT...

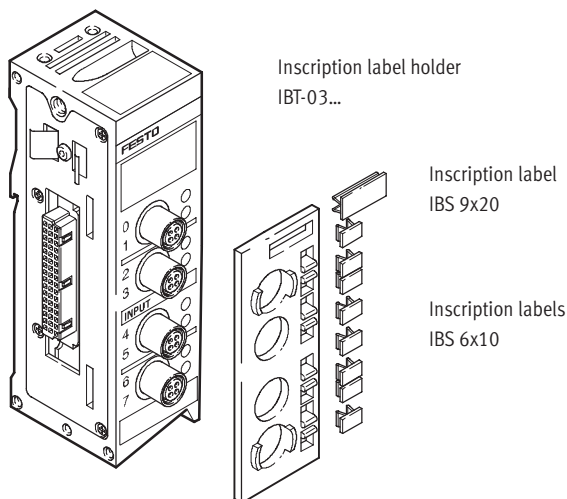

- The inscription label holder is pushed-in
- The inscription is created using inscription labels

Inscription labels

Technical data – Inscription label holders

Examples illustrating the attachment of inscription label holders

VMPA1-ST-...

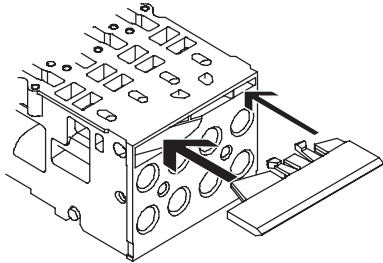

Inscription label holder
VMPA1-ST...

- The inscription label holder is locked into recesses on the valve terminal
- The inscription is created by inserting identification strips

MPA-...

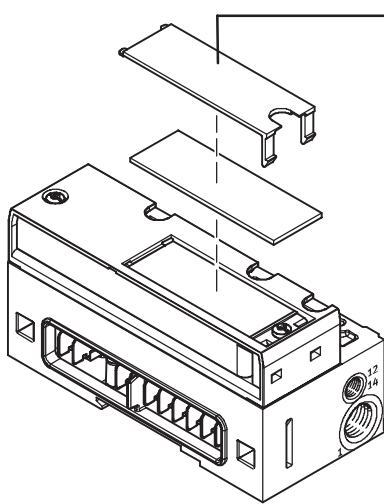

Inscription label holder

Identification strips

- The inscription label holder is locked into recesses on the valve terminal (cover, plug)
- The inscription is created by inserting identification strips

MVH-BZ (similar to MN2H-BZT-...)

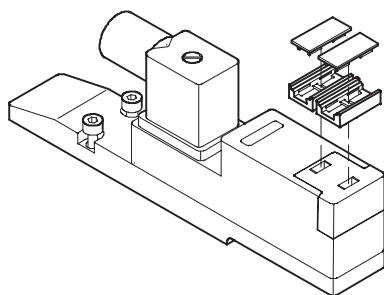

Inscription labels
IBS 9x17

Inscription label holder
MVH-BZ

- The inscription label holder is locked into recesses on the valve
- The inscription is created using inscription labels