

Valve terminals type 10 CPV10-EX-VI, Compact Performance

FESTO



- Compact Performance: Maximum flow with minimum space requirement
- For use in potentially explosive areas
- Installation-saving fitting in a control cabinet
- Short tubing lengths, short cycle times
- Huge range of valve functions
- Integrated assembly and installation concept
- Pneumatic multiple connector plate
- 24-hour delivery service

Valve terminals type 10 CPV10-EX-VI, Compact Performance

Key features

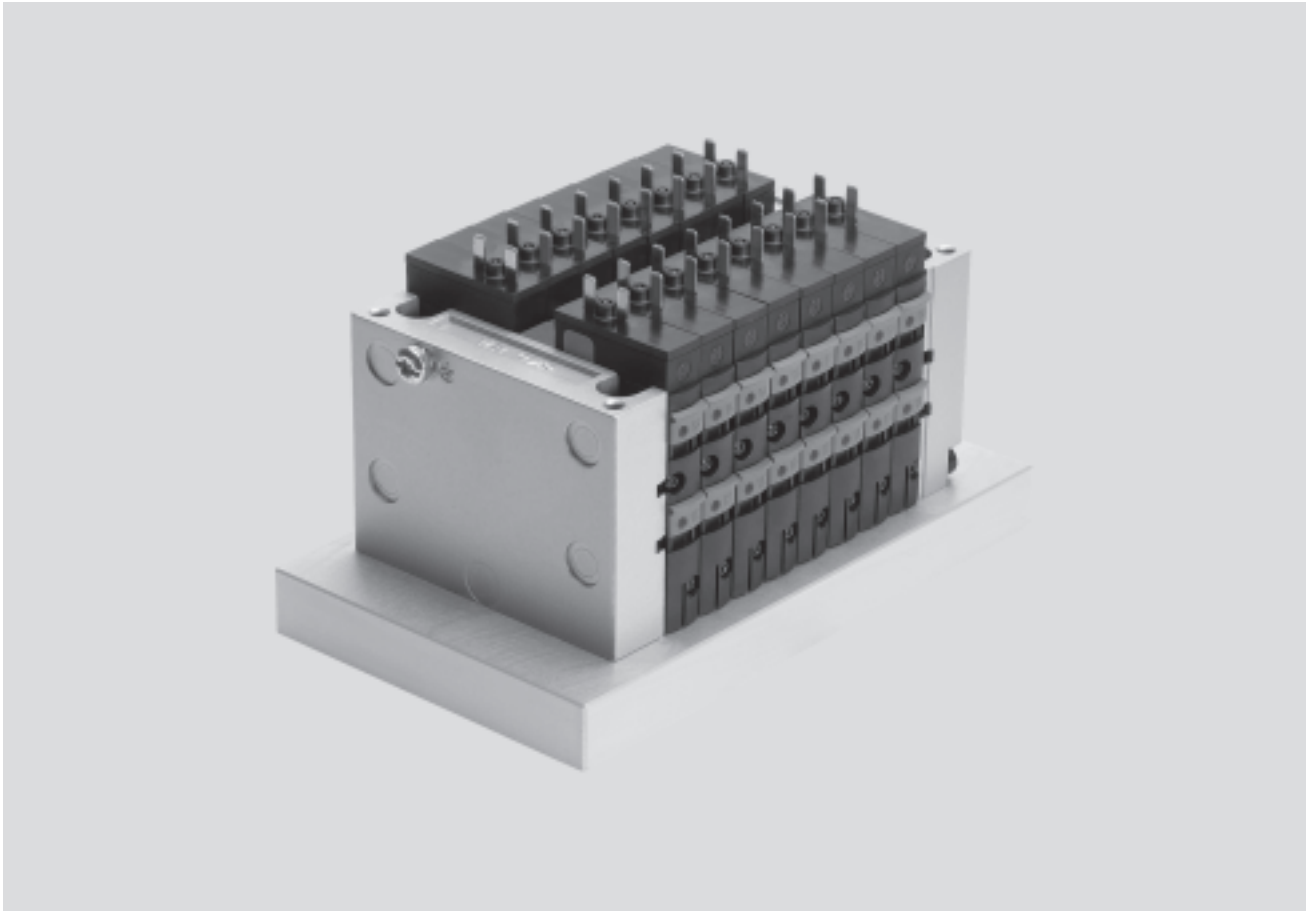

Innovative

- Cubic design for exceptional performance and low weight
- Sturdy
- Optimized for installation in a control cabinet
- Suitable for pilot control of process valves
- High flow rate with extremely compact design

Versatile

- Up to sixteen 2/2- or 3/2-way valves per valve terminal thanks to two-fold function in each slice
- Flexible and cost-effective connection of two to eight valve slices
- Highly flexible thanks to:
 - various pneumatic functions (valve variants)
 - different pressure ranges
- Separator plates for the formation of pressure zones
- Blanking plates for future expansion

Reliable

- Manual valve overrides
- Protection class to IP65 in control cabinet
- Intrinsically safe valve terminal design to ATEX Category 2 (Zone 1)
- Extremely robust thanks to the metal valve design
- Long service life

Easy to mount

- Ready-to-install unit, pre-assembled and tested
- Lower cost of selection, ordering, installation and commissioning
- Secure wall mounting or H-rail mounting
- Pneumatic multiple connector plate – fast replacement of the valve block without the need to replace the existing tubing connections
- Valve assembly optimised for control cabinets

Valve terminals type 10 CPV10-EX-VI, Compact Performance

Key features

Peripherals overview

Simple electrical connections:
– Individual connection

Quick mounting:

- Directly using screws
- On a H-rail
- Via the pneumatic multiple connector plate

Robust metal thread or pre-assembled QS connections

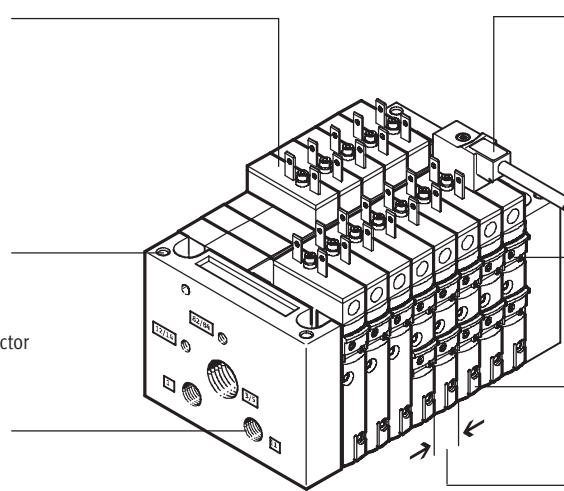

Inscription labels

Reliable operation:
Pushing, detenting or blocked manual override

Comprehensive range of valve functions, pressure zone creation, blanking plates

Width
– 10 mm

Equipment options

Valve functions

- 5/2-way single pilot valve
- 5/2-way valve double solenoid
- 2x 3/2-way valve, normally open
- 2x 3/2-way valve, normally closed
- 2x 3/2-way valve, 1x normally open, 1x closed
- 5/3-way valve¹⁾
- 2x 2/2-way valve, normally closed
- 2x 2/2-way valve, 1x normally open, 1x closed

Special features

Individual connection

- 2 ... 8 valve positions, max. 16 solenoid coils

Intrinsically safe

The valve terminal CPV10-EX-VI features an intrinsically safe design for use in potentially explosive areas to ATEX Category 2 (Zone 1).

Pneumatic multiple connector plate

Pneumatic multiple connector plate for wall opening facilitates installation in control cabinets, seal to IP65.

Operation

Actuation only via intrinsically safe circuit with individual valve connection.

1) Via function block, not in conjunction with pneumatic multiple connector

Valve terminals type 10 CPV10-EX-VI, Compact Performance

Key features

Valve terminal configurator

Online via: → www.festo.com

A valve terminal configurator is available to help you select a suitable valve terminal CPV. This makes it much easier to find the right product.

The valve terminals are fully assembled according to your order specifications and individually tested. This reduces assembly and installation time to a minimum. You order a valve terminal type 10 using the order code.

Ordering system for type 10
→ Internet: type 10 CPV10-EX-VI

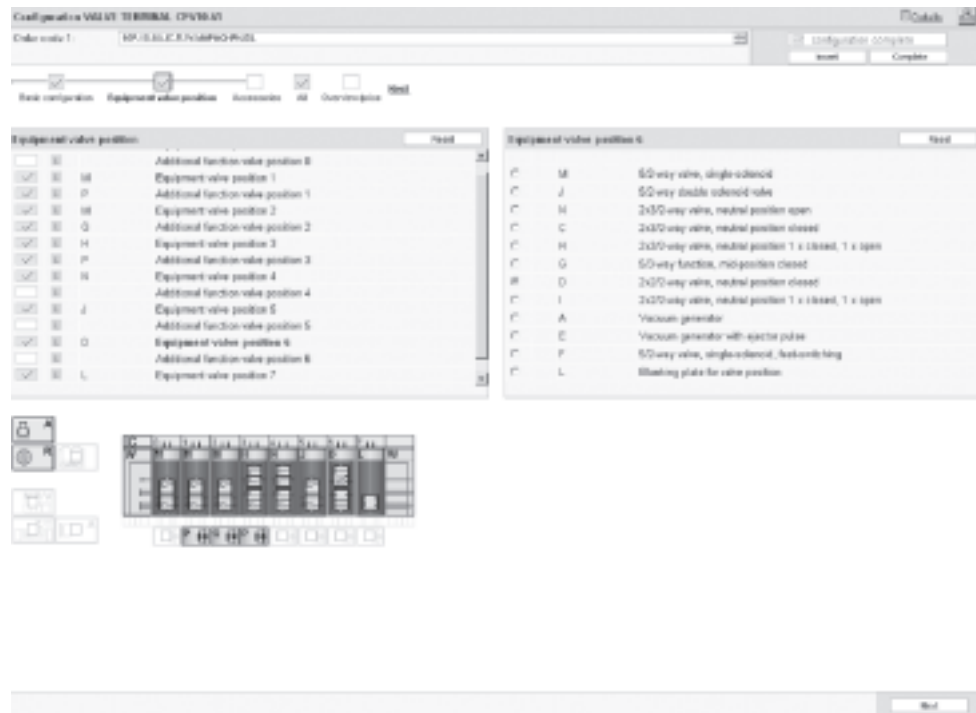

The illustration above provides an example of a valve terminal configuration. The following steps explain how you arrive at the order code:

Once you have called up → www.festo.com, select the online version of the digital product catalogue from the “Products” submenu. Activate the “Direct Search” menu.

You can enter a “Part No.” (e.g. 539506), “Type” (e.g. CPV10) or “Article Designation” (e.g. valve terminal) to find your “Search result”. Click on the blue shopping basket to complete the selected product according to your specifications (this does not initiate an order).

Open the basket and click on the symbol “Configurable”. You can then configure the valve terminal step by step (from the top down) according to your requirements. Select the “Finish” menu to continue on with the ordering process.

2D/3D CAD data

Online via: → www.festo.com

You can request the CAD data for a valve terminal you have configured. To do this, perform the product search as described above. Enter the shopping basket and click on the CAD icon

(compass). On the next screen you can generate a 3D preview or request another data format of your choice by e-mail.

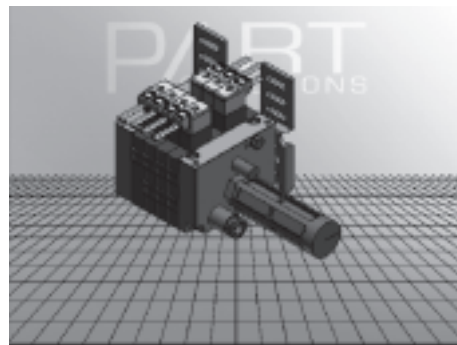

Valve terminals type 10 CPV10-EX-VI, Compact Performance

Key features

Electrical connections

Individual connection in explosion-proof design

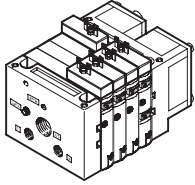

The CPV10-EX-VI is a valve terminal featuring an intrinsically safe design for use in Zone 1 potentially explosive areas (ATEX Category 2 G).
 Definition of intrinsically safe:
 Intrinsically safe means that the electrical outputs and solenoid coils are

designed so that no sparks or thermal effects will trigger ignition in explosive atmospheres. Each valve coil must be connected to an intrinsically safe circuit that complies with ignition protection type ia IIC or ib IIC.

Individual connection facilitates the selection of 2 to 16 solenoid coils (divided between two to eight valve slices, odd numbers also possible).

Range of applications

Many applications involve explosive gases or dust. Applications such as these call for equipment with increased explosion protection requirements (Category 2 corresponding to Zone 1). The possibility of sparking, for example when a solenoid coil is switched off, must be completely ruled out. There are different ways of doing this. Solenoid coils for this type of application are usually “intrinsically safe”. Intrinsically safe here means that no sparks or thermal effects can occur that would trigger ignition in an explosive atmosphere.

The valve terminal family CPV10 is already approved for explosion protection areas to ATEX. This approval is valid for Category 3. It corresponds to Zone 2 in which an explosive atmosphere either normally does not occur or occurs only briefly.
 The valve terminal CPV10-EX-VI extends this range for higher ATEX requirements:



- Approval for Category 2, Zone 1.

The intrinsically safe valve terminal features an integrated protective circuit that prevents ignition for gas, mist or vapour. Circuits for intrinsically safe solenoid coils are also designed so that only low voltage and power levels can occur. Hence, in this case the valve terminal is equipped with individually connected valves. The CPV10-EX-VI may only be operated in suitable intrinsically safe circuits.

In process engineering, valves for pilot control of process valves are frequently installed in the control cabinet. The pneumatic multiple connector plate type CPV10-VI-...-M7-C or -D for control cabinets simplifies the installation of the pneumatic connections. Instead of multiple bulkhead fittings and pipe connections, installation can be performed with just a single through-hole in the cabinet wall. Protection class IP65 is achieved via a sealing ring suitable for closed control cabinet assembly. The pneumatic multiple connector plate facilitates operation of the valve terminal CPV10-EX-VI in the control cabinet in Zones 1 and 21 (ATEX Category 2 GD).

Valve terminals type 10 CPV10-EX-VI, Compact Performance

Key feature

Certification	
 	<p>In accordance with EU directive 94/9/EC (ATEX directive) Use in hazardous locations II 2 G Ex ib IIc T5 -5°C ≤ Ta ≤ 50°C</p>

CPV use in Zone 1/2

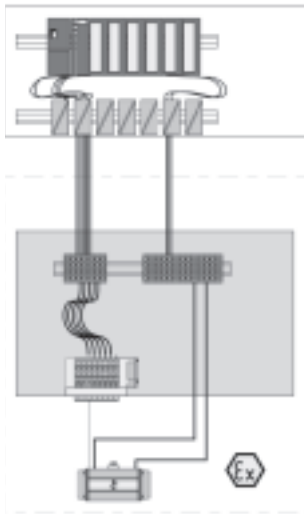

Intrinsically safe valve terminal in the control cabinet. Control via multi-core connecting cable.

CPV use in Zone 1/2

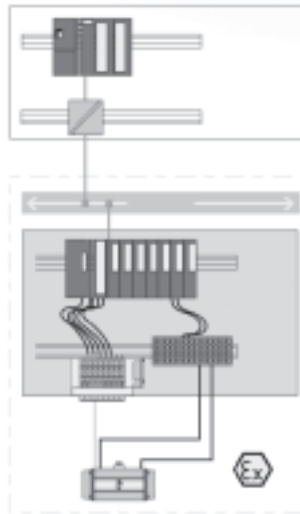

Intrinsically safe valve terminal (pneumatic multiple connector plate) and remote I/O in the control cabinet.

Valve terminals type 10 CPV10-EX-VI, Compact Performance

Key feature

What does ATEX mean?

Explosive atmospheres are a constant hazard in the chemical and petro-chemical industries because of the processing techniques used. These explosive atmospheres are caused by escaping gas, vapours and mist, for example. Explosive atmospheres must also be considered in mills, silos and sugar and feed processing plants because of the dust/oxygen mixtures that occur there. For this reason, electrical equipment in hazardous areas is subject to a special directive, ATEX 95a. This directive was also extended to non-electrical equipment on July 1, 2003.

What does ATEX 95a stand for and what does it mean?

- ATEX is an acronym of the French expression "Atmosphère explosible"
- ATEX 95a refers to article 95a of the corresponding EU directive
- ATEX 95a is a working title for a project related to the **directive 94/9/EC:**
- **Directive 94/9/EC** stipulates the minimum safety requirements for equipment and protective systems to be operated in explosive atmospheres.
- It applies to all EU member states.
- It relates to both electrical and non-electrical equipment.

What are the main amendments introduced by directive 94/9/EC?

- Non-electrical equipment such as cylinders, pneumatic valves, service units and accessories now fall within the scope of the directive.
- Equipment will be approved for specific categories. These categories are allocated zones in which the equipment can be operated.
- Each piece of equipment must be supplied with operating instructions and a conformity declaration.
- The manufacturer's quality system must meet specifications over and above those required under ISO 9001.
- The new equipment bears the explosion protection and CE marks.
- Dust explosion protection now also falls within the scope of this directive.
- It specifies general safety requirements.
- It applies to mining as well as all other hazardous areas.
- It applies to complete protective systems.

Explosion protection classes

Gas zone	Dust zone	Frequency	Equipment group	Equipment category	Area of application
			I	M	Mining
				M1	
				M2	
			II		All non-mining areas of application
0		Constant, frequent, long-term	II	1G	Gas, mist, vapour
	20		II		1D
1		Occasional	II	2G	Gas, mist, vapour
	21		II		2D
2		Seldom, short-term in the event of a fault	II	3G	Gas, mist, vapour
	22		II		3D

Valve terminals type 10 CPV10-EX-VI, Compact Performance

Key feature

CPV – The benefits at a glance

The CPV valve terminal is of unique design. It permits the flexible combination of pneumatic performance, electrical connection technologies and a wide range of mounting options. The pneumatic multiple connector in particular can be fitted in a control cabinet thereby saving space. The valve terminal can often be fitted directly in the previously unused wall area of the control cabinet. It is not necessary to wire the valves inside the

control cabinet. All tubing connections can be laid outside. Instead of individual holes, the pneumatic multiple connector requires only a rectangular cutout. The generously sized flow ducts and powerful flat plate silencers ensure high flow rates. This means that even comparatively large pneumatic cylinders can be driven with ease. All valves are in the form of valve slices. They are optimised for flow

performance and are also extremely compact. Two functions per valve slice (e.g. 2x 3/2-way valves) mean that twice the component density can be achieved. This saves space and reduces costs. The cubic design permits exceptional performance yet a comparatively low weight. The benefits of this design are obvious when the valve terminal is used on a moving installation. However robustness must not be

sacrificed in favour of compactness. The connecting thread and mounting attachments are metallic. The manual override for the valves can be adapted for different operating situations. If, for example, a detenting manual override is required for setting-up mode, the manual override can be easily converted for that application in a way that rules out operational errors.

The design principle

The cubic design provides a clearly assigned function on each side. Thus, for example, the electrical connection is mounted on the top surface.

The different combination options ensure the optimum solution for the task at hand.

- Pneumatic supply connections on the left, right or underneath
- Pneumatic working ports and functional modules (vertical stacking) underneath
- Manual operation from the front
- Electrical connection surface on the top
- Mounting surface on the back or even on the front via a pneumatic multiple connector plate

Valve terminals type 10 CPV10-EX-VI, Compact Performance

Peripherals overview

Overview – CPV valve terminal

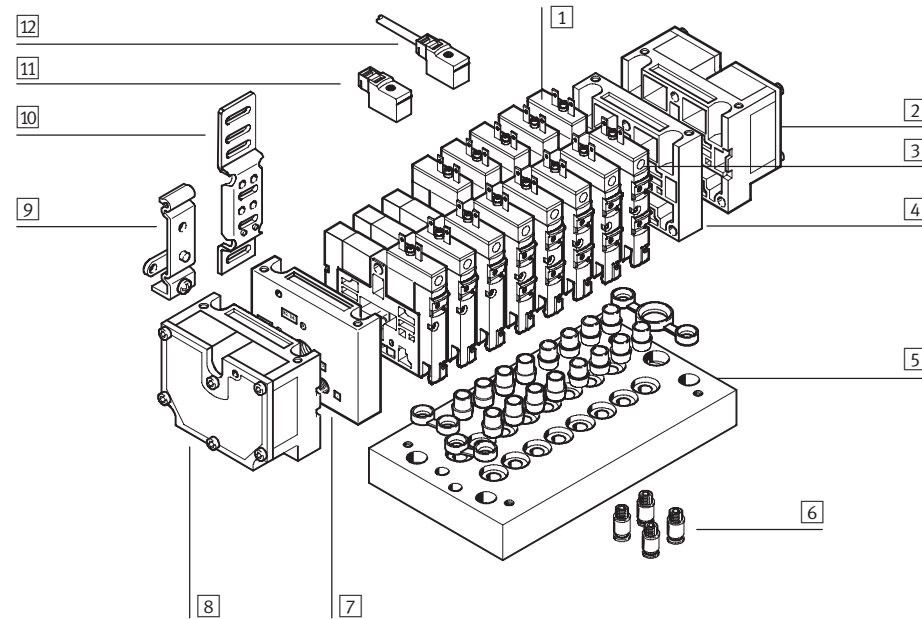

- | | | | |
|---|--|--|--|
| <ul style="list-style-type: none"> 1 Basic electrical unit (individual connection) 2 Right-hand end plate with flat plate silencer 3 Valve slice | <ul style="list-style-type: none"> 4 Right-hand end plate (threaded connections not in combination with pneumatic multiple connector plate) 5 Pneumatic multiple connector plate | <ul style="list-style-type: none"> 6 QS push-in fittings 7 Left-hand end plate (threaded connections not in combination with pneumatic multiple connector plate) 8 Left-hand end plate with flat plate silencer | <ul style="list-style-type: none"> 9 H-rail mounting 10 Wall mounting 11 Plug socket for self-assembly 12 Plug socket with cable |
|---|--|--|--|

Valve terminals type 10 CPV10-EX-VI, Compact Performance

Key features – Pneumatic components

Valves

CPV valves are integrated sub-base valves, i.e. in addition to the valve function they contain all of the pneumatic ducts for supply, exhaust and

the working ports. The supply ducts are a central part of the valve slices and allow a direct flow of air through the valve slices.

This helps achieve maximum flow rates. All valves have a pneumatic pilot control for optimising performance. The valve function is based on a

piston spool system with a patented sealing principle that guarantees its suitability for a wide range of applications as well as a long service life.

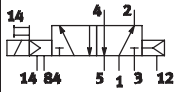
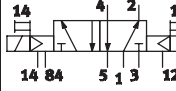
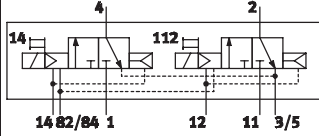
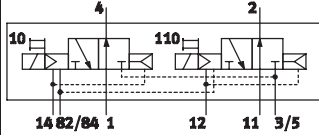
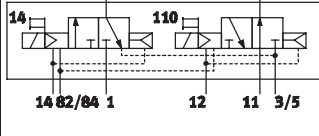
Valve function			
Code	Circuit symbol	Size	Description
		10	
M		■	5/2-way single pilot valve <ul style="list-style-type: none"> • Pneumatic spring return • For controlling double-acting cylinders or processing drives
J		■	5/2-way double pilot valve <ul style="list-style-type: none"> • For controlling double-acting cylinders or processing drives • When the current is switched off, the pneumatic switch position is maintained
C		■	2x 3/2-way single pilot valve <ul style="list-style-type: none"> • Normally closed • Pneumatic spring return • For controlling single-acting cylinders
N		■	2x 3/2-way single pilot valve <ul style="list-style-type: none"> • Normally open • Pneumatic spring return • The function of a 5/3-way valve pressurised in mid-position can be realised with these valves in the open initial position
H		■	2x 3/2-way single pilot valve <ul style="list-style-type: none"> • Normal position • 1x open (pilot control 12) • 1x closed (pilot control 14) • For optimised cylinder movement. Corresponds to valve function M with simultaneous actuation of both solenoid coils (5/2-way, single pilot). Since the piston area on each side can be pressurised or exhausted separately, it means that the cylinder can move faster • Pneumatic spring return

Valve terminals type 10 CPV10-EX-VI, Compact Performance

Key features – Pneumatic components

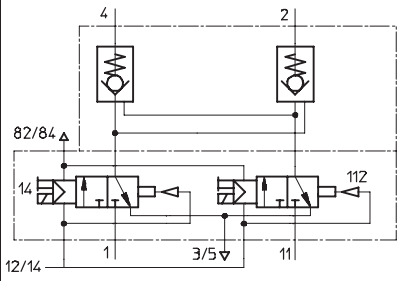
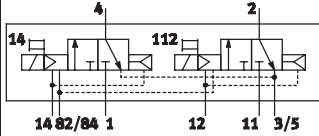
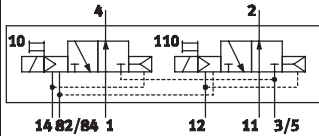
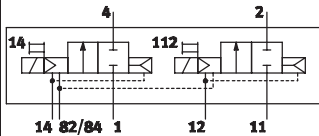
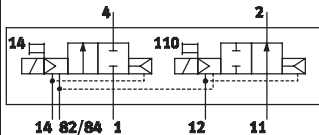
Valve function		Size	Description
Code	Circuit symbol		
		10	<p>5/3G function¹⁾, mid-position closed</p> <p>The valve function “mid-position closed” is created from a 2x 3/2-way valve, normally closed (code C). The valve kit CPV10-BS-5/3G-M7 (which incorporates a double piloted non-return function) is used for this. This valve kit is intended for applications with one working pressure level per valve slice, i.e. it must not be used in dual-pressure applications (where there are different pressure levels at port 1 and 11).</p> <p>If other valve slices are to be used in dual-pressure mode, then the valve slice equipped with the 5/3G valve kit must be separated from compressed air channel 1 and 11 by means of a separator plate (code T). Not in first or last valve position.²⁾</p>
			<p>5/3E function, mid-position exhausted</p> <p>The valve function “mid-position exhausted” is created from a 2x 3/2-way valve, normally closed (code C).</p> <ul style="list-style-type: none"> • Pneumatic spring return
			<p>5/3B function, mid-position pressurised</p> <p>The valve function “mid-position pressurised” is created from a 2x 3/2-way valve, normally open (code N).</p> <ul style="list-style-type: none"> • Pneumatic spring return
D			<p>2x 2/2-way single pilot valve</p> <ul style="list-style-type: none"> • Normally closed • Pneumatic spring return
I			<p>2x 2/2-way single pilot valve</p> <ul style="list-style-type: none"> • Normal position 1x open 1x closed • Control side 14 normally closed • Control side 12 normally open • Pneumatic spring return

1) Cannot be mounted in combination with the pneumatic multiple connector plate CPV10-VI-P...-C or CPV10-VI-P...-D for control cabinets

2) Pneumatic multiple connector plate P, M: Not in first or last valve position
Pneumatic multiple connector plate GQC, GQD: Cannot be used

Valve terminals type 10 CPV10-EX-VI, Compact Performance

Key features – Pneumatic components

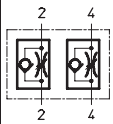
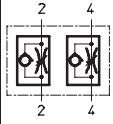
Additional pneumatic functions			
Code	Circuit symbol	Size	Description
		10	
P	<p>Input (valve side)</p>  <p>Output (cylinder side)</p>	■	<p>2x one-way flow control valve, supply air flow control</p> <p>Module (actuator) for direct flange mounting on the CPV valves. Different valve actuators cannot be combined.</p> <ul style="list-style-type: none"> • Not with valve function G • Not in first or last valve position with accessories M, P, V (pneumatic multiple connector plate) • Not suitable with accessories GQC and GQD (pneumatic multiple connector)
Q	<p>Input (valve side)</p>  <p>Output (cylinder side)</p>	■	<p>2 x one-way flow control valve, exhaust air flow control</p> <p>Module (actuator) for direct flange mounting on the CPV valves. Different valve actuators cannot be combined.</p> <ul style="list-style-type: none"> • Not with valve function G • Not in first or last valve position with accessories M, P, V (pneumatic multiple connector plate) • Not suitable with accessories GQC and GQD (pneumatic multiple connector)

	Note
Pneumatic multiple connector plate	Pneumatic multiple connector plate
P, M:	GQC, GQD:
Not in first or last valve position.	Cannot be used.

Valve terminals type 10 CPV10-EX-VI, Compact Performance

Key features – Pneumatic components

Creating pressure zones

Different pressures at port 1 and 11 result in two pressure levels per valve. This means, for example, that a cylinder drive can be extended with high pressure and retracted with low pressure to save energy.

The maximum number of pressure zones possible is determined by the combination of the following components:

- Use of a separator plate
- End plate pair type
- Valve slice type

You can divide the CPV valve terminal into 2 to 4 pressure zones by using separator plates.

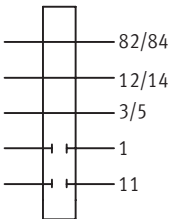
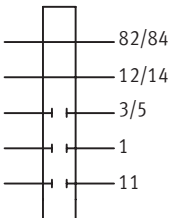
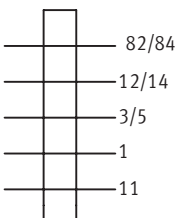
Separator plates			
Code	Graphical symbol	Size	Note
		10	
T	Separator plate (for creation of pressure zones), supply duct 1 separated 	■	A separator plate (code T) is used to separate the duct for the air supply (port 1 and 11) to provide two pressure zones. <ul style="list-style-type: none"> • Not in first or last valve position • Not with compressed air supply A, B, C, D, U, V, W, X
S	Separator plate (for creation of pressure zones), supply duct 1 and exhaust 3/5 separated 	■	The separator plate (code S) interrupts the exhaust duct 3/5 as well as the supply duct 1 and 11. This plate should be used to prevent backpressures on neighbouring valve functions. <ul style="list-style-type: none"> • Not in first or last valve position • Not with compressed air supply A, B, C, D, U, V, W, X (single-side compressed air supply)
L	Vacant position (blanking plate) 	■	A vacant position is formed by using a blanking plate (code L) and a valve can be positioned here at a later date.

Valve terminals type 10 CPV10-EX-VI, Compact Performance

Key features – Pneumatic components

Examples: Pneumatic supply

External pilot air supply, flat plate silencer at both ends

Pneumatic supply via pneumatic multiple connector plate:
code H

The diagram opposite shows an example of the configuration and connection of the compressed air supply with external pilot air supply. Port 12/14 on the pneumatic multiple connector plate is equipped with a fitting for this purpose. Ports 3/5 and 82/84 are vented via the flat plate silencer. One separating seal each can be used optionally to create pressure zones.

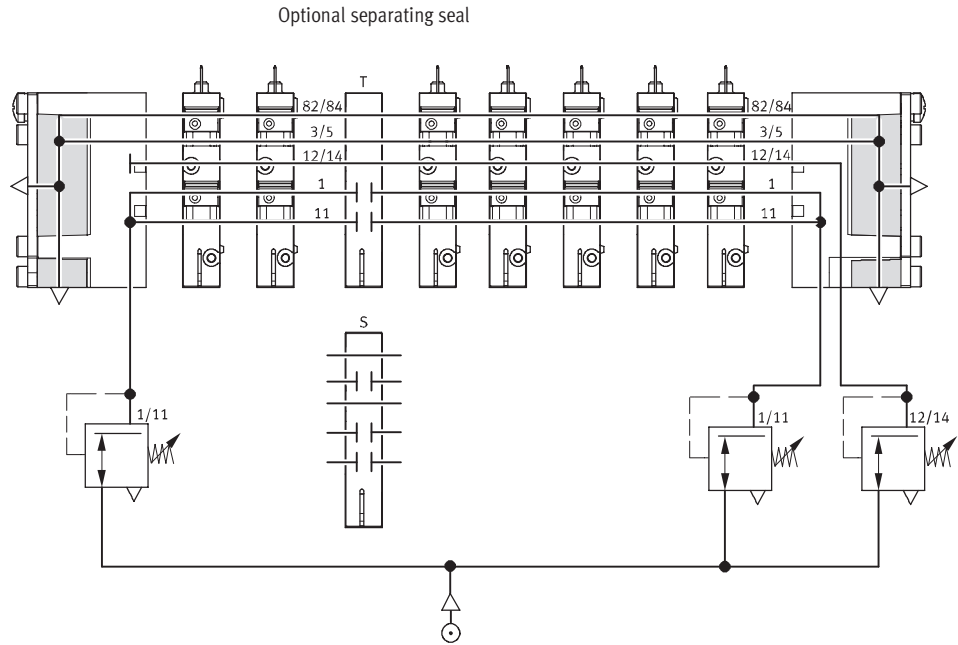

Internal pilot air supply, ducted exhaust air or screw-in silencer

Pneumatic supply via end plates:
code Z

The diagram opposite shows an example of the configuration and connection of the compressed air supply with internal pilot air supply. Here the pilot supply air is branched from port 1 or 11 via the right-hand end plate. Ports 3/5 and 82/84 are vented via the screw-in silencer. One separating seal each can be used optionally to create pressure zones.

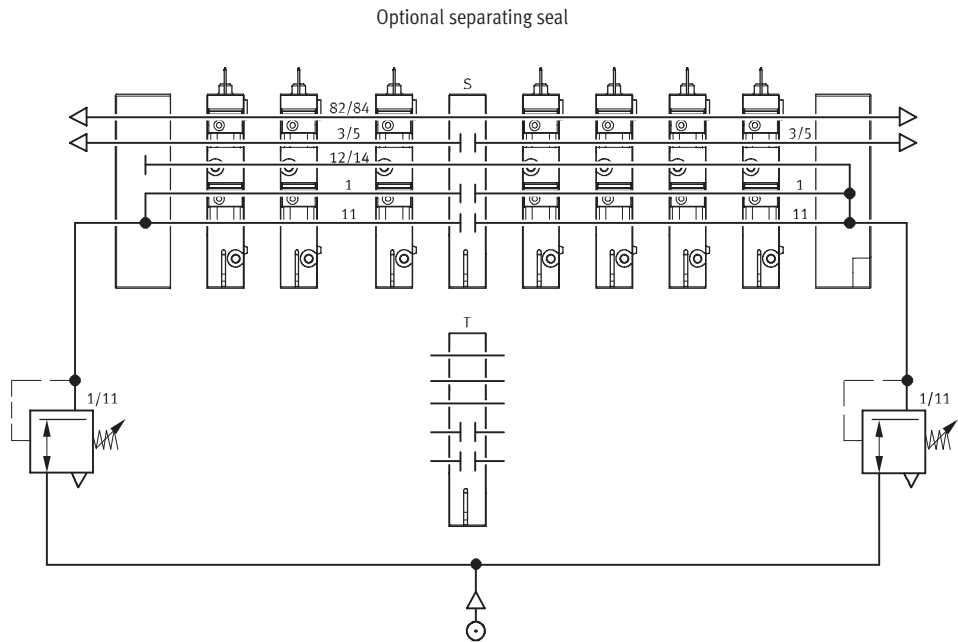

Valve terminals type 10 CPV10-EX-VI, Compact Performance

Key features – Pneumatic components

Example: Creation of pressure zones

CPV with separator plate T

The valve terminal CPV facilitates the creation of up to 4 pressure zones. The diagram shows an example of the configuration and connection of four pressure zones using separator plate code T – with external pilot air supply.

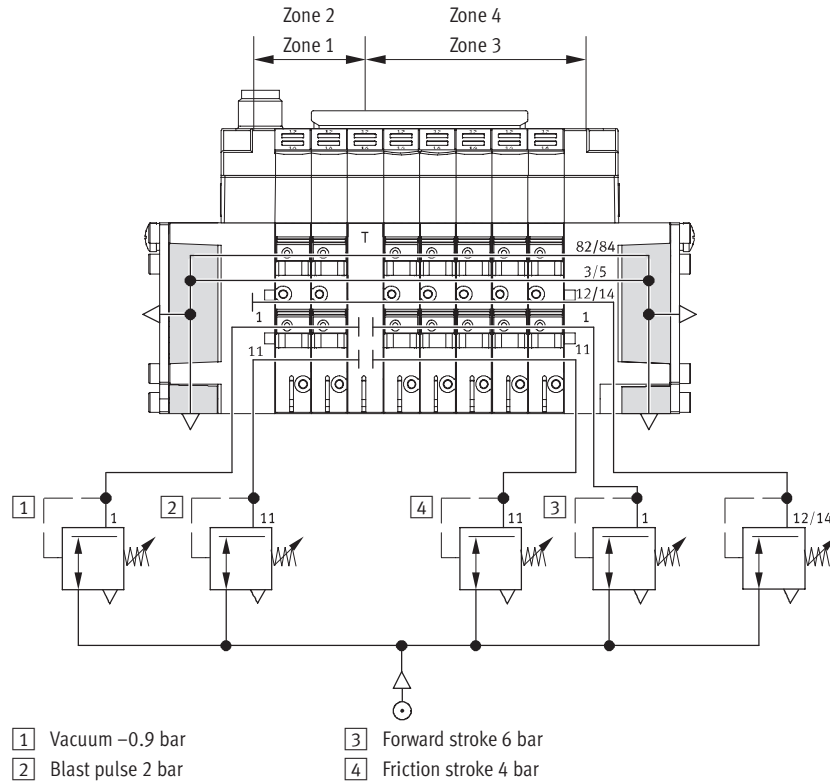

Valve terminals type 10 CPV10-EX-VI, Compact Performance

Key features – Pneumatic components

Compressed air supply and exhausting

The two end plates which supply the valve slices with pressure and exhaust them are a characteristic feature of a CPV valve terminal.

- Large duct cross sections ensure maximum flow rates even when multiple valves are switched in parallel

- Large flat plate silencers in the end plates
- Internal/external pilot air supply

Each individual valve is supplied with compressed air from two individual

ducts (supply ports 1/11) and exhausted via a large, integrated exhaust duct (exhaust 3/5). This design permits unique flexibility and functionality. It is the easiest way of realis-

ing a number of pressure zones per terminal.

The valve terminal is supplied via end plates, either on the left, on the right, or on both sides.

Pilot air supply

Internal pilot air supply:

An internal pilot air supply can be selected if the supply pressure at pneumatic connection 1 is 3 ... 8 bar. The branch is located in the left-hand or right-hand end plate with an internal pilot air supply. There is no port 12/14.

External pilot air supply:

An external pilot air supply is required if the supply pressure at pneumatic connection 1 is ≤ 3 bar or ≥ 8 bar. In this case, pressure of 3 ... 8 bar is applied at port 12/14.

If a gradual pressure build-up in the system using a soft-start valve is required, an external pilot air supply should be selected so that the control pressure applied during switch-on is already very high.

End plates

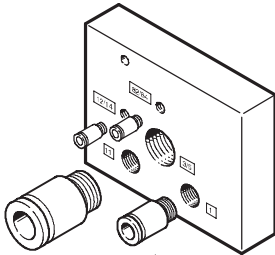

Example of an end plate: The figure shows a left-hand end plate with external pilot air supply. The exhaust ports 3/5 and 82/84 can be

supplied as screwed connections or with silencers. Ports 12/14 and 11 are not provided on end plates used for internal pilot air supply.

Port 82/84 is always present and should be fitted with a silencer. Port 12/14 is internally connected via port 1.

Valve terminals type 10 CPV10-EX-VI, Compact Performance

Key features – Pneumatic components

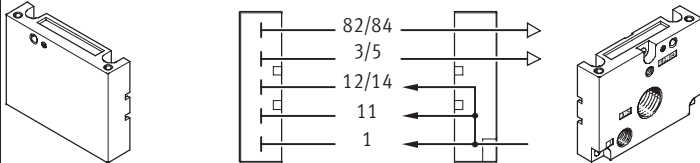
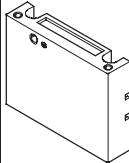
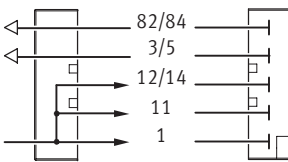
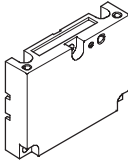
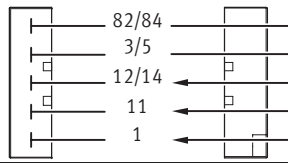
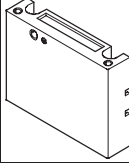
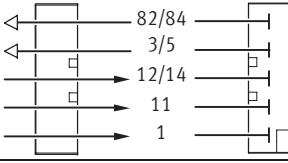
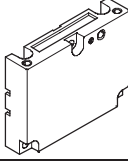
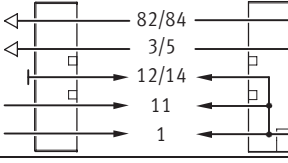
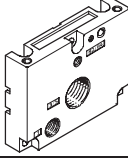
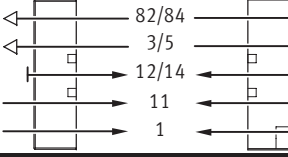
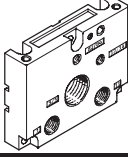
End plate combination for compressed air supply via end plate			
Code	Graphical symbol Type of pilot air supply (internal/external)	Size	Note
		10	
U	Internal pilot air supply 		<ul style="list-style-type: none"> • Ports in right-hand end plate only • No pressure zone separation permissible
V	Internal pilot air supply 		<ul style="list-style-type: none"> • Ports in left-hand end plate only • No pressure zone separation permissible
W	External pilot air supply 		<ul style="list-style-type: none"> • Ports in right-hand end plate only • No pressure zone separation permissible
X	External pilot air supply 		<ul style="list-style-type: none"> • Ports in left-hand end plate only • No pressure zone separation permissible
Y	Internal pilot air supply 		<ul style="list-style-type: none"> • Ports in left-hand and right-hand end plate • Max. 3 pressure zones
Z	External pilot air supply 		<ul style="list-style-type: none"> • Ports in left-hand and right-hand end plate • Max. 4 pressure zones

Valve terminals type 10 CPV10-EX-VI, Compact Performance

Key features – Pneumatic components

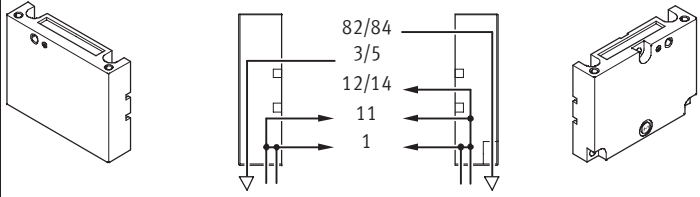
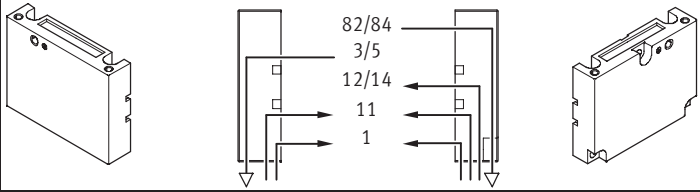
End plate combination for compressed air supply via pneumatic multiple connector plate			
Code	Graphical symbol Type of pilot air supply (internal/external)	Size	Note
		10	
Y	Internal pilot air supply 	■	<ul style="list-style-type: none"> Ports on pneumatic multiple connector plate Pressure zone separation only permissible with separator plate (code T) Max. 2 pressure zones Valves to the left of the separator plate suitable for vacuum Only for accessories M, P, V, GQC, GQD (pneumatic multiple connector plate)
Z	External pilot air supply 	■	<ul style="list-style-type: none"> Ports on pneumatic multiple connector plate Pressure zone separation only permissible with separator plate (code T) Max. 3 pressure zones Suitable for vacuum Only for accessories M, P, V, GQC, GQD (pneumatic multiple connector plate)

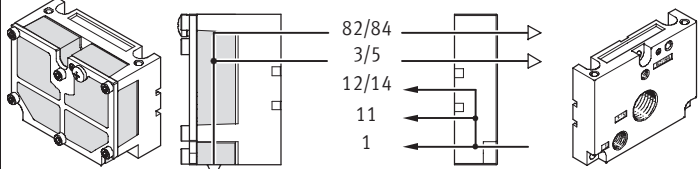
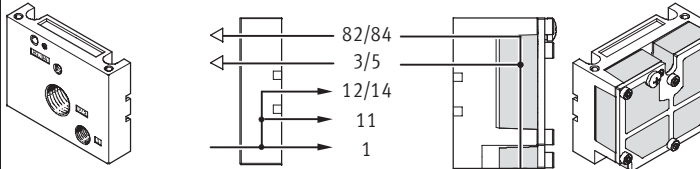
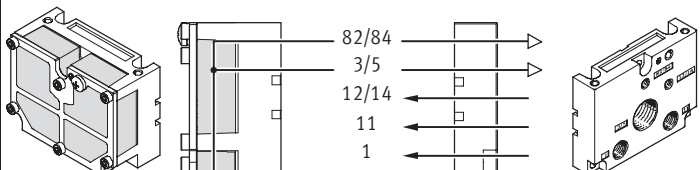
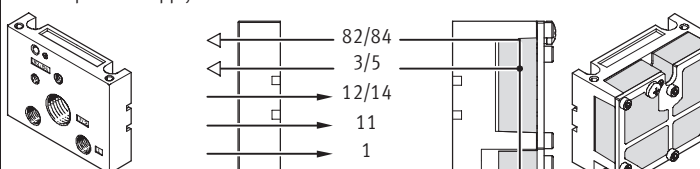
End plate combination for compressed air supply via end plates with flat plate silencer			
Code	Graphical symbol Type of pilot air supply (internal/external)	Size	Note
		10	
A	Internal pilot air supply 	■	<ul style="list-style-type: none"> Ports in right-hand end plate No pressure zone separation permissible
B	Internal pilot air supply 	■	<ul style="list-style-type: none"> Ports in left-hand end plate No pressure zone separation permissible
C	External pilot air supply 	■	<ul style="list-style-type: none"> Ports in right-hand end plate No pressure zone separation permissible
D	External pilot air supply 	■	<ul style="list-style-type: none"> Ports in left-hand end plate No pressure zone separation permissible

Valve terminals type 10 CPV10-EX-VI, Compact Performance

Key features – Pneumatic components

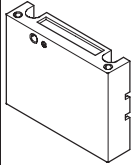
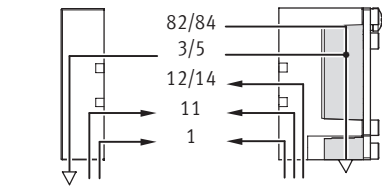
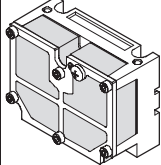
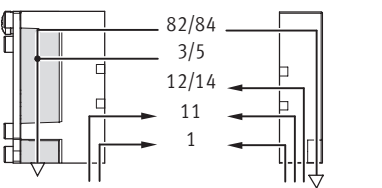
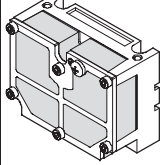
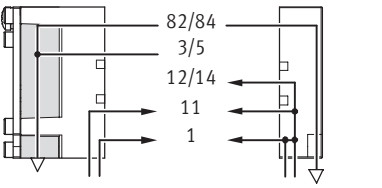
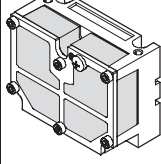
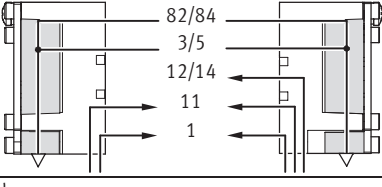
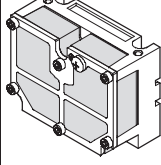
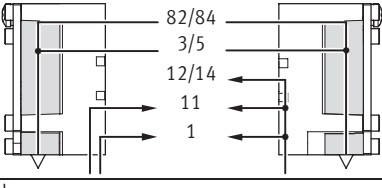
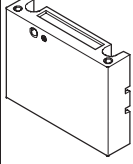
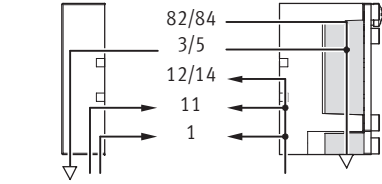
End plate combination for compressed air supply via pneumatic multiple connector plate with flat plate silencer			
Code	Graphical symbol Type of pilot air supply (internal/external)	Size	Note
		10	
E	External pilot air supply 		<ul style="list-style-type: none"> Ports on pneumatic multiple connector plate Exhaust air vented via flat plate silencers at right Pressure zone separation only permissible with separator plate (code T) Max. 4 pressure zones Only for accessories M, P, V, GQC, GQD (pneumatic multiple connector plate)
F	External pilot air supply 		<ul style="list-style-type: none"> Ports on pneumatic multiple connector plate Exhaust air vented via flat plate silencers at left Pressure zone separation only permissible with separator plate (code T) Max. 4 pressure zones Only for accessories M, P, V, GQC, GQD (pneumatic multiple connector plate)
G	Internal pilot air supply 		<ul style="list-style-type: none"> Ports on pneumatic multiple connector plate Exhaust air vented via flat plate silencers at left Pressure zone separation only permissible with separator plate (code T) Max. 3 pressure zones Only for accessories M, P, V, GQC, GQD (pneumatic multiple connector plate)
H	External pilot air supply 		<ul style="list-style-type: none"> Ports on pneumatic multiple connector plate Exhaust air vented via flat plate silencers at both ends Pressure zone separation permissible Only for accessories M, P, V, GQC, GQD (pneumatic multiple connector plate)
J	Internal pilot air supply 		<ul style="list-style-type: none"> Ports on pneumatic multiple connector plate Exhaust air vented via flat plate silencers at both ends Pressure zone separation permissible Max. 3 pressure zones Only for accessories M, P, V, GQC, GQD (pneumatic multiple connector plate)
K	Internal pilot air supply 		<ul style="list-style-type: none"> Ports on pneumatic multiple connector plate Exhaust air vented via flat plate silencers at right Pressure zone separation permissible Max. 3 pressure zones Only for accessories M, P, V, GQC, GQD (pneumatic multiple connector plate)

Valve terminals type 10 CPV10-EX-VI, Compact Performance

Key features – Pneumatic components

Pneumatic connection

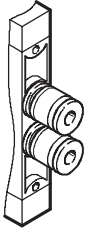

The working ports are located directly in the valve slices. Threaded connections and Quick Star push-in fittings (QS) are available for different tubing sizes. The supply ports are located in the end plates or in the pneumatic

multiple connector plate. Push-in fittings are available fully assembled. The following working ports can be selected:

- Large push-in fittings: code A
 - Small push-in fittings: code B
 - Threaded connections: code C
- Connection sizes for the threaded and QS push-in fittings can be found in the table below.

Pneumatic multiple connector plate

One-piece sub-bases which contain both working ports and supply ports are available in combination with a pneumatic multiple connector plate. These sub-bases enable the valve terminal as a pneumatic “function” to

be separated from the tubing connections. The pneumatic multiple connector plate facilitates different mounting options from wall mounting to direct passage through a housing wall.

Easy-to-service and flexible connection technology thanks to the following:

- Common connection via the pneumatic multiple connector plate with all connections on one side

- The valve terminal can be removed/fitted using only 4 screws, while the pneumatic components remain fully connected
- Quick removal/fitting
- No faults when recommissioning as a result of incorrect connection of tubing

Pneumatic multiple connector plate

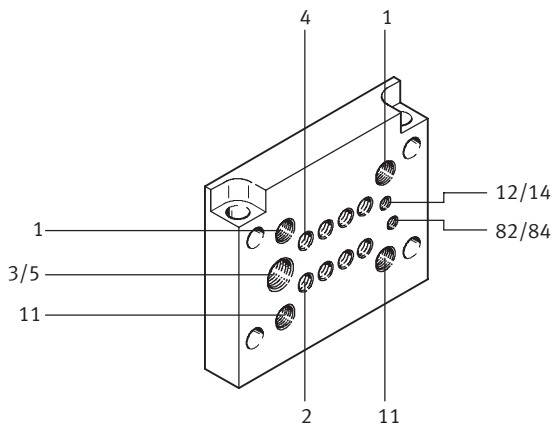

CPV valve terminal

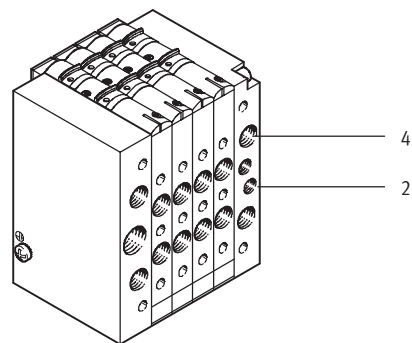

Connection sizes		
Connection to ISO 5599	CPV10	Remarks
1/11 Supply air	G1/8	Fitting in end plate or pneumatic multiple connector plate
2/4 Working port	M7 (QS6/QS4)	Connection in valve slice, connection for push-in fitting in brackets
3/5 Exhaust air via right-hand/left-hand end plate or pneumatic multiple connector plate	G3/8	
	G1/4	
12/14 Pilot air supply port	M5	
82/84 Pilot exhaust air via right-hand/left-hand end plate or pneumatic multiple connector plate	M5	
	M7 (M5) ¹⁾	

1) With pneumatic multiple connector plate with flange

Valve terminals type 10 CPV10-EX-VI, Compact Performance

Key features – Pneumatic components

Pneumatic connection: Fitting set for pneumatic supply			
Pneumatic supply code	Connection	Designation	Size 10 QS6 Type
Without pneumatic multiple connector plate			
U, V	82/84	Silencer	U-M5
	3/5	Silencer	U-3/8-B
	1	Push-in fitting	QS-1/8-8-I
W, X	82/84	Silencer	U-M5
	3/5	Silencer	U-3/8-B
	1	Push-in fitting	QS-1/8-8-I
	12/14	Push-in fitting	QSM-M5-6-I
Y	82/84 on right	Silencer	U-M5
	82/84 on left	Blanking plug	B-M5
	3/5 on right	Silencer	U-3/8-B
	3/5 on left	Blanking plug	B-3/8
	1/11 on left	Push-in fitting	QS-1/8-8-I
Z	82/84 on right	Silencer	U-M5
	82/84 on left	Blanking plug	B-M5
	3/5 on right	Silencer	U-3/8-B
	3/5 on left	Blanking plug	B-3/8
	12/14 on right	Push-in fitting	QSM-M5-6-I
	12/14 on left	Blanking plug	B-M5
	1/11	Push-in fitting	QS-1/8-8-I
With pneumatic multiple connector plate code: M			
Y	82/84	Silencer	UC-M7
	12/14	Blanking plug	B-M7
	3/5	Silencer	U-1/4-B
	1/11 on left	Push-in fitting	QS-1/8-8-I
	11 on right	Blanking plug	B-1/8
Z	82/84	Silencer	UC-M7
	3/5	Silencer	U-1/4-B
	12/14	Push-in fitting	QSM-M7-6-I
	1/11 on left	Push-in fitting	QS-1/8-8-I
With pneumatic multiple connector plate code: P, GQC			
Y	82/84	Silencer	U-M5
	12/14	Blanking plug	B-M5
	3/5	Silencer	U-1/4-B
	1/11 on left	Push-in fitting	QS-1/8-8-I
	11 on right	Blanking plug	B-1/8
Z	82/84	Silencer	U-M5
	3/5	Silencer	U-1/4-B
	12/14	Push-in fitting	QSM-M5-6-I
	1/11 on left	Push-in fitting	QS-1/8-8-I

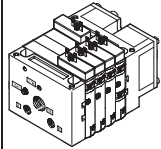

Valve terminals type 10 CPV10-EX-VI, Compact Performance

Key features – Pneumatic components

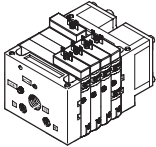
Pneumatic connection: Fitting set for pneumatic supply				
Pneumatic supply code	Connection	Designation	Size 10 QS6 Type	
	Without pneumatic multiple connector plate			
	A, B	82/84	Blanking plug	B-M5
		3/5	Blanking plug	B-3/8
		1	Push-in fitting	QS-1/8-8-I
	C, D	82/84	Blanking plug	B-M5
		3/5	Blanking plug	B-3/8
		1	Push-in fitting	QS-1/8-8-I
		12/14	Push-in fitting	QSM-M5-6-I
	With pneumatic multiple connector plate code: M			
	E, F, H	82/84	Blanking plug	B-M7
		3/5	Blanking plug	B-1/4
		1/11	Push-in fitting	QS-1/8-8-I
		12/14	Push-in fitting	QSM-M7-6-I
	G, J, K	82/84	Blanking plug	B-M7
		3/5	Blanking plug	B-1/4
		on right in 1, left	Push-in fitting	QS-1/8-8-I
		on right in 11	Blanking plug	B-1/8
		12/14	Blanking plug	B-M7
	With pneumatic multiple connector plate code: P, GQC			
	E, F, H	82/84	Blanking plug	B-M5
		3/5	Blanking plug	B-1/4
		1/11	Push-in fitting	QS-1/8-8-I
		12/14	Push-in fitting	QSM-M5-6-I
	G, J, K	82/84	Blanking plug	B-M5
3/5		Blanking plug	B-1/4	
on right in 1, left		Push-in fitting	QS-1/8-8-I	
on right in 11		Blanking plug	B-1/8	
12/14		Blanking plug	B-M5	

Valve terminals type 10 CPV10-EX-VI, Compact Performance

Key features – Pneumatic components

CPV valve terminal size 10 with valve extensions

Function blocks

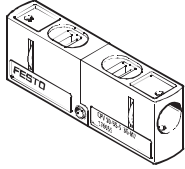

CPV10-BS-5/3G-M7

Valve kit 5/3G for creating a 5/3-way function, mid-position closed, for size 10:
The valve function “mid-position closed” is created from a valve slice with 2x 3/2-way valve, normally closed (valve function code C).

The valve kit CPV10-BS-5/3G-M7 (which incorporates a double piloted non-return function) is used for this.

This valve kit is intended for applications with one working pressure level per valve slice, i.e. it may not be used in dual-pressure applications (where there are different pressure levels at port 1 and 11).

Additional functions for valve positions

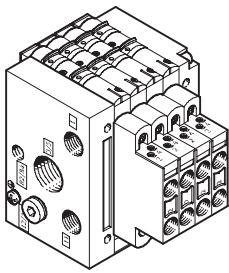

These valve extensions (vertical stacking) can be used to add further pneumatic functions to CPV valve terminals size 10:

- Two one-way flow control valves for flow regulation directly at the valve terminal for
 - supply air flow control
 - exhaust air flow control

The additional functions cannot be used in the first or last valve position in combination with the pneumatic multiple connector plate.

2x one-way flow control valve for supply air flow control
Additional function code P

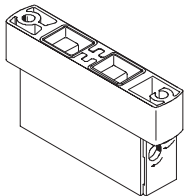

CPV10-BS-2xGRZZ-M7

2x one-way flow control valve for exhaust air flow control
Additional function code Q

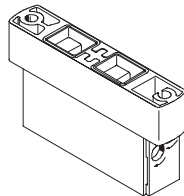

CPV10-BS-2xGRAZ-M7

Valve terminals type 10 CPV10-EX-VI, Compact Performance

Key features – Mounting

Mounting options

The valve terminals have holes for four mounting screws, the mounting side is the pneumatic threaded connector side. These holes are also used to mount a valve terminal on the pneumatic multiple connector plate.

There are other mounting options in addition to this mounting method:

- H-rail mounting
- Wall mounting
- Wall mounting via flanged pneumatic multiple connector plate

- On rear side via wall mounting
- On front side
- Mounting via through-hole in wall

The attachments are mounted with a screw and fixing bolt on the left-hand and right-hand end plates.

Examples of mounting options

H-rail: Mounting code H

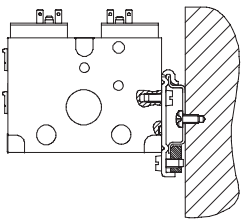

for valve terminal CPV10:
CPV10/14-VI-BG-NRH-35
(mounting code H)

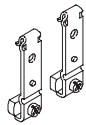

for valve terminal CPV10:
CPV10/14-VI-BG-RWL-B
(mounting code U)



H-rail to EN 60715 not for accessories
M, P, V
(pneumatic multiple connector plate)

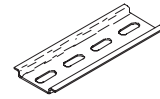

Wall mountings

Through-hole in wall, for example on the machine

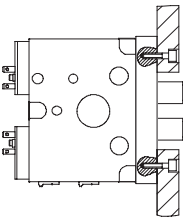

Wall mounting via pneumatic multiple connector plate

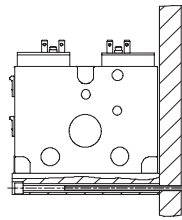

Attachment for wall mounting

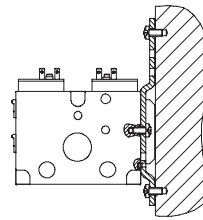

Mounting for individual connection (mounting code X)

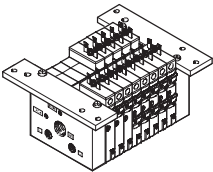

for valve terminal CPV10

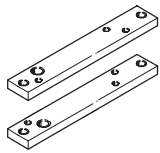

 Note

The valve terminal CPV10-EX-VI must not be operated on the Siematic ET 200X. The mounting kit may only

be used for front mounting of the valve terminal.

Valve terminals type 10 CPV10-EX-VI, Compact Performance

Key features – Mounting

Pneumatic multiple connector plate for wall/machine mounting

with flange, code P

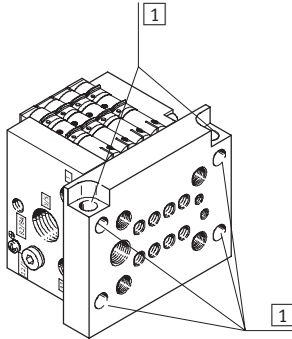

1 Mounting holes

- Multiple connector plate projects past the end plates
- Through mounting holes (without thread) in the flange
- Two additional holes running crossways through this multiple connector plate also facilitate rear mounting of the CPV valve terminal

without flange, code M

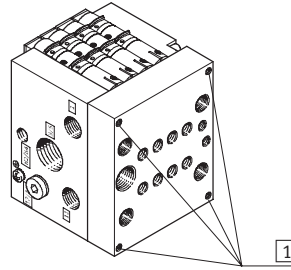

1 Mounting holes

- Multiple connector plate fits flush with the end plates
- Mounting holes (with thread) for wall or foot mounting are on the connection side of the pneumatic multiple connector plate

Pneumatic multiple connector plate for control cabinet assembly

with supply ports, code GQC

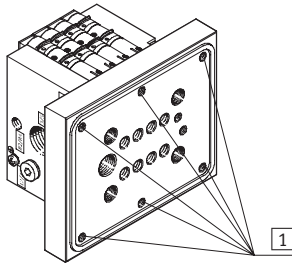

1 Mounting holes

- Multiple connector plate projects past the end plates
- Mounting holes (with thread) in the flange
- Multiple connector plate with seal

without supply ports, code GQD

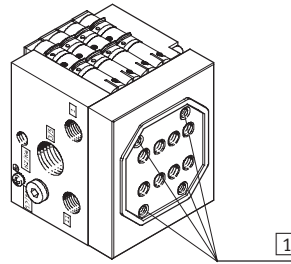

1 Mounting holes

- Multiple connector plate fits flush with the end plates
- The mounting holes (with thread) are on the connection side of the pneumatic multiple connector plate
- Multiple connector plate with seal

Note

If the pneumatic multiple connector plate M or P is used, the outer valve discs cannot be fitted with valve extensions (e.g. one-way flow control valves).

In the case of CPV valve terminals with large surface-mounted silencer, only the wall fitting is possible.

If the pneumatic multiple connector plate GQC or GQD is used, the following limitations apply:

- Valve extensions cannot usually be fitted
- No combination with hat rail fastening
- No combination with wall fastening

Valve terminals type 10 CPV10-EX-VI, Compact Performance

Key features – Display and operation

Manual override

Three types of manual override are available:

- Non-detenting
- Detenting
- Blocked

A subsequent conversion of the manual override (MO) from non-detenting (pushing) to detenting or blocked is possible at any time.

The locking clip on the valve must be removed to this end. This is only possible after the individual valve has been removed or the tie rod of the valve terminal has been released.

 **Note**
See the user documentation for instructions.

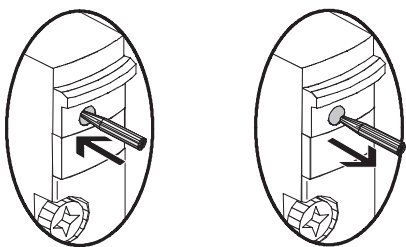
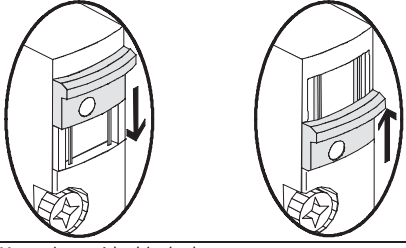
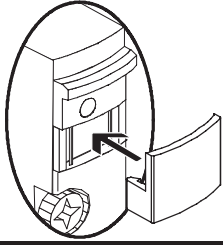
Code	Graphical symbol	Size 10	Note
N	Manual override, non-detenting 	■	In the non-detenting (“pushing”) version, the blue slide is held via a locking clip. A pointed object (e.g. pen, etc.) can be used to activate the MO through the opening.
R	Manual override, detenting 	■	In the “detenting” version, the manual override is activated by pushing the slide down. The pushing function can be re-established by re-installing the locking clip.
V	Manual override, blocked 	■	In the “blocked” version, detenting or non-detenting activation of the MO is prevented by means of a cover. Like the non-detenting locking clip, the cover can be added subsequently, but then remains on the valve.

Valve terminals type 10 CPV10-EX-VI, Compact Performance

Key features – Display and operation

Display and operation

Inscription labels

- Clip with identification field on the cable socket

CPV valve terminal with individual connections

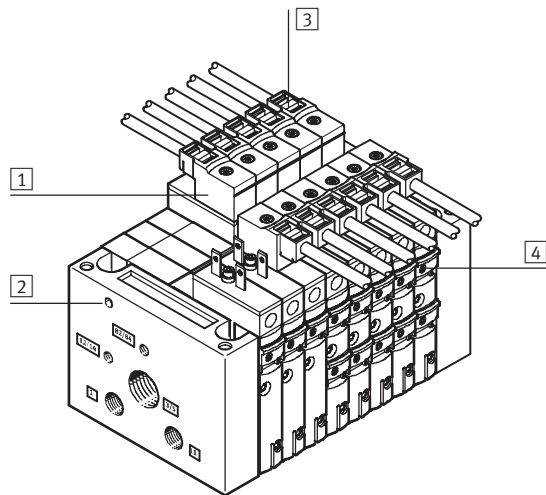

- 1 Pre-assembled connecting cable for each solenoid coil
- 2 Earth terminal
- 3 Inscription label (for each connection socket)
- 4 Manual override

Valve terminals type 10 CPV10-EX-VI, Compact Performance

Key features – Electrical components

Electrical connection

Individual connection



The corresponding individual connecting cables are generally designed without an LED. Plug sockets for self-assembly can also be ordered.

The CPV10-EX-VI must only be operated in suitable intrinsically safe circuits. A wide range of well-known manufacturers (list on request) offer

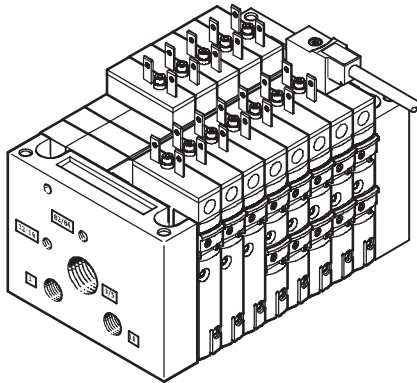
appropriate controllers, barriers or fieldbus circuits with intrinsically safe outputs.

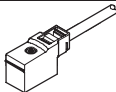

2 to 16 solenoid coils (divided between 2 ... 8 valve slices) can be selected, odd numbers also possible. The pneumatic multiple connector plate can only be used with even numbers.

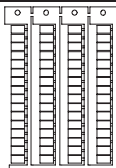
Ordering data					
	Code	Designation		Type	Part No.
Plug socket with cable					
	-	Plug socket with cable	0.5 m	KMYZ-4-0,5-B-EX	550 324
	-		2.5 m	KMYZ-4-2,5-B-EX	550 481
	-		5.0 m	KMYZ-4-5,0-B-EX	550 482
Plug socket for valves					
	-	Plug socket for self-assembly		KMYZ-4-0,0-B-EX	550 806
Inscription label					
		Inscription label		ISB 6x10	18 576

Valve terminals type 10 CPV10-EX-VI, Compact Performance

Key features – Electrical components

Dimensions – Connecting cable for individual connection

Download CAD data → www.festo.com

KMYZ-4-4-...-EX

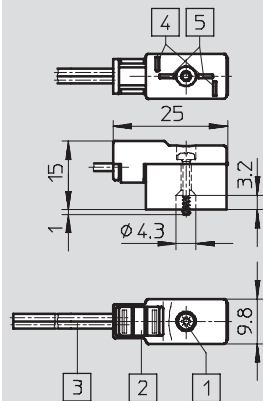

- | | |
|---|---|
| 1 Mounting screw (self-tapping KB 18x12), max. tightening torque 0.3 Nm | 3 2-wire (1x 0.35 mm ² 1x0.34 mm ²), cable length 0.5 or 2.5 m |
| 2 Inscription label | 4 Connection pattern for MSZB |
| | 5 Connection pattern for MSZC |

MSSD-MSZB

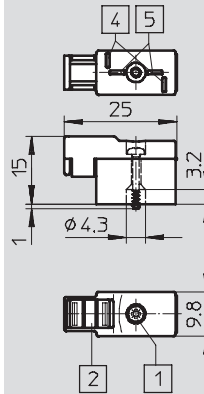

- | | |
|---|-------------------------------|
| 1 Mounting screw (self-tapping KB 18x12), max. tightening torque 0.3 Nm | 4 Connection pattern for MSZB |
| 2 Inscription label | 5 Connection pattern for MSZC |

Valve terminals type 10 CPV10-EX-VI, Compact Performance

FESTO

Instructions for use

Equipment

Operate your equipment with unlubricated compressed air if possible.

Festo valves and cylinders are designed so that, if used as designated, they will not require additional lubrication and will still achieve a long service life.

The quality of compressed air downstream from the compressor must correspond to that of unlubricated compressed air. If possible, do not operate all of your equipment with lubricated compressed air. The lubricators should, where possible, always be installed directly upstream of the actuator used.

Incorrect additional oil and too high an oil content in the compressed air reduces the service life of a valve terminal.

Use Festo special oil OFSW-32 or the alternatives listed in the Festo catalogue (as specified in DIN 51524-HLP32; basic oil viscosity 32 CST at 40 °C).

Bio-oils



When using bio-oils (oils which are based upon synthetic or native ester, e.g. rapeseed oil methyl ester), the maximum residual oil content of 0.1 mg/m³ must not be exceeded (see ISO 8573-1 Class 2).

Mineral oils

When using mineral oils (e.g. HLP oils to DIN 51524, parts 1 through 3) or similar oils based on poly-alpha-olefins (PAO), the maximum residual oil content of 5 mg/m³ must not be exceeded (see ISO 8573-1 Class 4). A higher residual oil content irrespective of the compressor oil cannot be permitted, as the basic lubricant would be flushed out over time.

Valve terminals type 10 CPV10-EX-VI, Compact Performance

Technical data

-  - Flow rate up to
400 l/min
-  - Valve width
10 mm
-  - Voltage
24 V DC

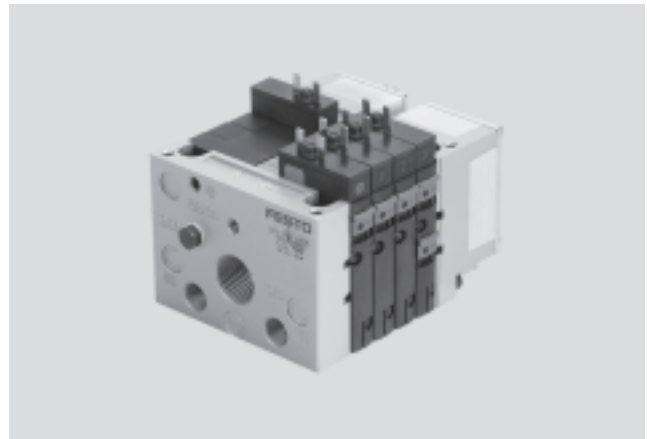

General technical data		CPV10-EX-VI
Constructional design		Electromagnetically actuated piston spool valve
Lubrication		Lifetime lubrication, PWIS-free (free of paint-wetting impairment substances)
Type of mounting		Via pneumatic multiple connector plate
		Via backwall
		On H-rail
Mounting position		Any
Manual override		Non-detenting (pushing)/detenting/blocked
Width	[mm]	10
Nominal diameter	[mm]	4
Nominal flow rate without fitting	[l/min]	400
Pneumatic connections ¹⁾		
Pneumatic connection		Via end plate or pneumatic multiple connector plate
Supply	1/11	G $\frac{1}{8}$
Exhaust	3/5	G $\frac{3}{8}$ (G $\frac{1}{4}$)
Working ports	2/4	M7
Pilot air supply	12/14	M5 (M7)
Pilot exhaust air	82/84	M5 (M7)

1) Connection dimensions in brackets for pneumatic multiple connector plate

Valve terminals type 10 CPV10-EX-VI, Compact Performance

Technical data

Operating and environmental conditions		M	J	N	C	H	D	I
Valve function order code								
Operating medium		Filtered compressed air, lubricated or unlubricated, inert gases → 30						
Grade of filtration	[µm]	40 (average pore size)						
Operating pressure	[bar]	0 ... 10						
Operating pressure for valve terminal with internal pilot air supply	[bar]	3 ... 8						
Pilot pressure	[bar]	3 ... 8						
Ambient temperature	[°C]	-5 ... +50						
Temperature of medium	[°C]	-5 ... +50						
Storage temperature	[°C]	-20 ... +40						
Relative air humidity at 25 °C	[%]	90 with no condensation						
Corrosion resistance class CRC ¹⁾		2						

1) Corrosion resistance class 2 to Festo standard 940 070
 Components requiring moderate corrosion resistance. Externally visible parts with primarily decorative surface requirements which are in direct contact with a normal industrial environment or media such as coolants or lubricating agents.

Valve response times [ms]		M	J	N	C	H	D	I
Valve function order code								
Response times	on	17	–	17	17	17	15	15
	off	40	–	37	37	37	17	17
	change-over	–	10	–	–	–	–	–

Valve terminals type 10 CPV10-EX-VI, Compact Performance

Technical data

Electrical data – Valve solenoid		
Width	[mm]	10
Max. ambient temperature	[°C]	+50
Max. input voltage V_i	[V DC]	32
Max. input current I_i	[A]	0.2
Max. input power P_i	[W]	0.76
Required current consumption with pilot pressure of 3 bar ¹⁾	[mA]	≥15.4
Effective internal inductance L_i	[μH]	≈0
Effective internal capacity C_i	[nF]	≈0
Resistance R_{20}	[Ω]	920 ±5%
Power supply		Only from certified intrinsically safe circuits EEx ia IIC or ib IIC
Duty cycle	[%]	100
ATEX symbol		II 2 G Ex ib II C T5
ATEX ambient temperature	[°C]	-5 ≤ Ta ≤ +50
Protection class to EN 60529	[IP]	40
	[IP]	65 with pneumatic multiple connector plate for control cabinets
Relative humidity	[%]	90%

1) With higher pilot pressure the minimum current consumption is reduced

Data on vibration and shock in accordance with DIN/EC68	
Vibration resistance	Tested to DIN/IEC 68/EN 60068, parts 2-6 Severity level 2
Shock resistance	Tested to DIN/IEC 68, parts 2-27 Severity level 2

Materials	
Valve slices	Die-cast aluminium
Valve module 5/3G	Cast aluminium, polyacetate
Blanking plate/separator plate	Polyamide
End plates	Die-cast aluminium
Flat plate silencer	Die-cast aluminium, polyethylene
Pneumatic multiple connector plate	Wrought aluminium alloy
Seal	Nitrile rubber

Valve terminals type 10 CPV10-EX-VI, Compact Performance

Technical data

Product weight	
Approx. weights	[g]
End plates (2 pieces)	160
Pneumatic multiple connector plate	
• on valve terminal with 2 valve positions	120
• on valve terminal with 4 valve positions	165
• on valve terminal with 6 valve positions	225
• on valve terminal with 8 valve positions	270
Flat plate silencer	147
Blanking plate	25
Separator plate	25
Valve slice	65
Function block: 5/3G function	46
Function block: One-way flow control valves	25

Valve terminals type 10 CPV10-EX-VI, Compact Performance

Technical data

Dimensions

Download CAD data → www.festo.com

Valve terminal CPV10-EX-VI with supply ports in the end plates

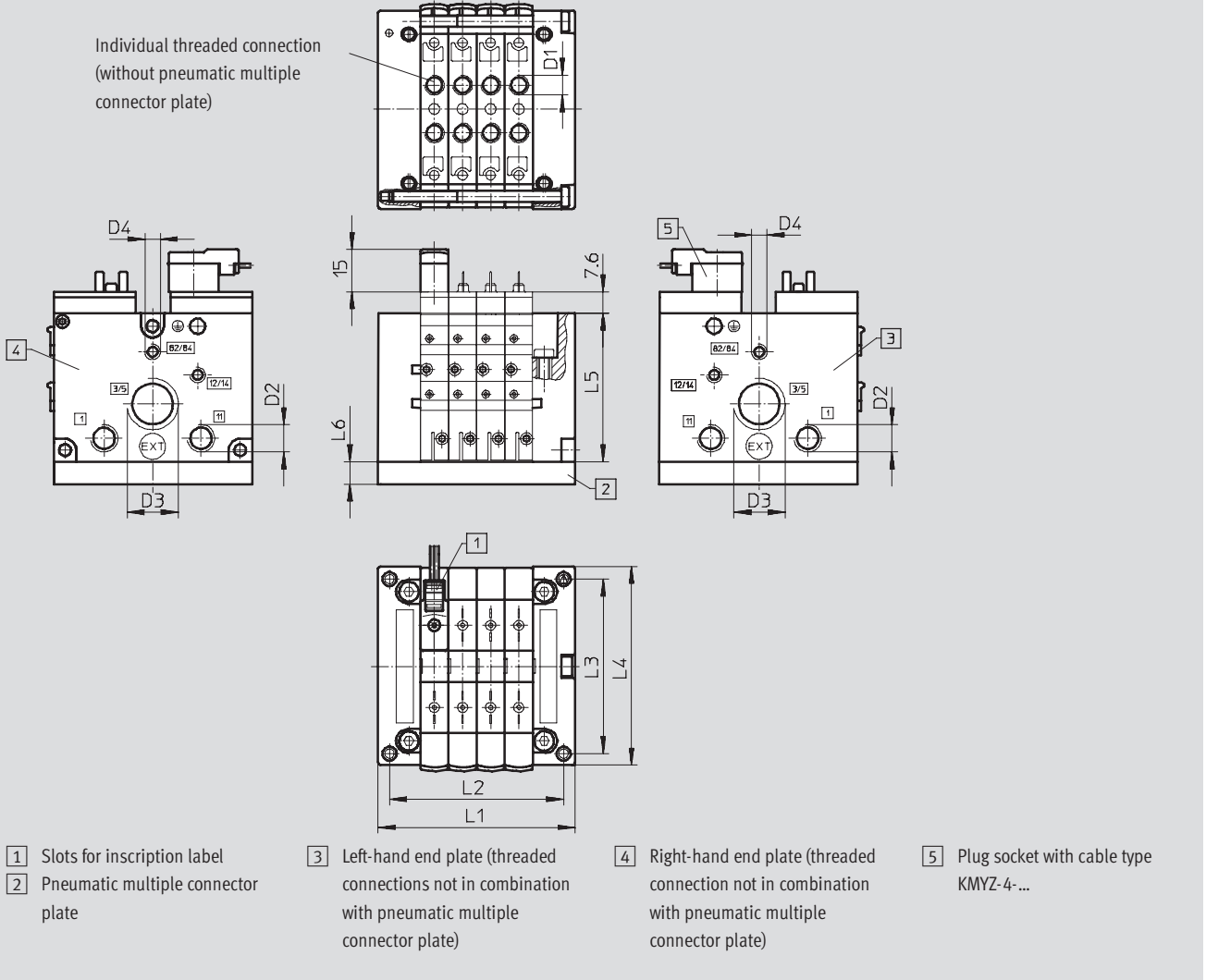

	L1	L2	L3	L4	L5	L6	D1	D2	D3	D4
2-fold	50	41.8	62	71	52.8	15	M7	G $\frac{1}{8}$	G $\frac{3}{8}$	M5
3-fold	60	51.8								
4-fold	70	61.8								
5-fold	80	71.8								
6-fold	90	81.8								
7-fold	100	91.8								
8-fold	110	101.8								

Valve terminals type 10 CPV10-EX-VI, Compact Performance

Technical data

Dimensions

Download CAD data → www.festo.com

Valve terminal CPV10-EX-VI with flat plate silencer

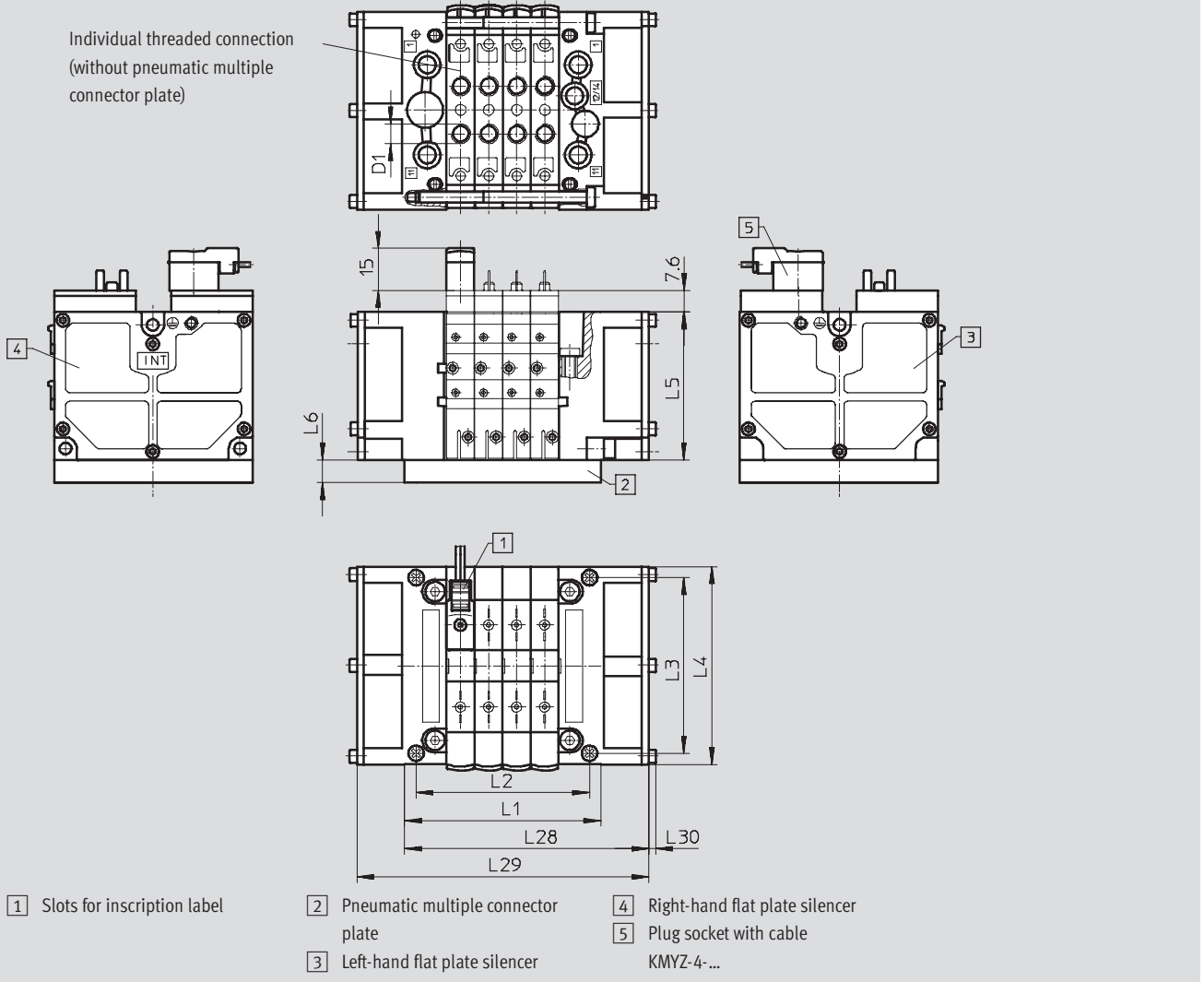

	L1	L2	L3	L4	L5	L6	L28	L29	L30	D1
2-fold	50	41.8	62	71	52.8	15	67	84	2.5	M7
3-fold	60	51.8					77	94		
4-fold	70	61.8					87	104		
5-fold	80	71.8					97	114		
6-fold	90	81.8					107	124		
7-fold	100	91.8					117	134		
8-fold	110	101.8					127	144		

Valve terminals type 10 CPV10-EX-VI, Compact Performance

Technical data

Dimensions

Download CAD data → www.festo.com

Attachment CPV10-VI-BG-RWL-B for wall mounting

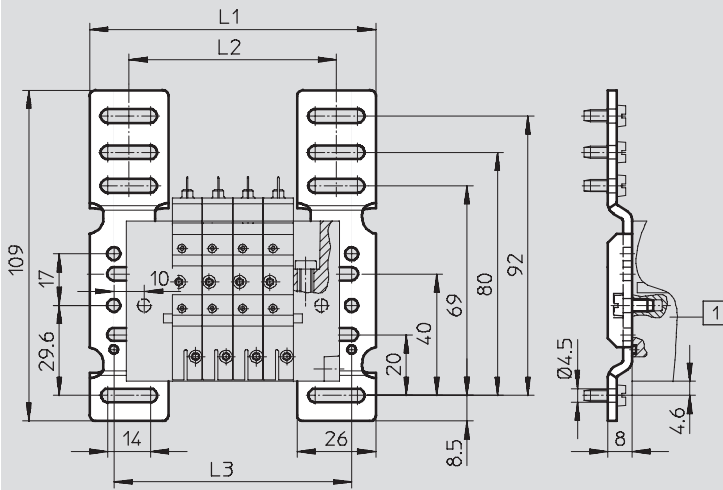

1 Valve terminal CPV10-EX-VI

	2-fold	3-fold	4-fold	5-fold	6-fold	7-fold	8-fold
L1	74	84	94	104	114	124	134
L2	48	58	68	78	88	98	108
L3	58	78	88	98	108	118	128

Dimensions

Download CAD data → www.festo.com

Attachment CPV10-VI-BG-ET200X for top mounting

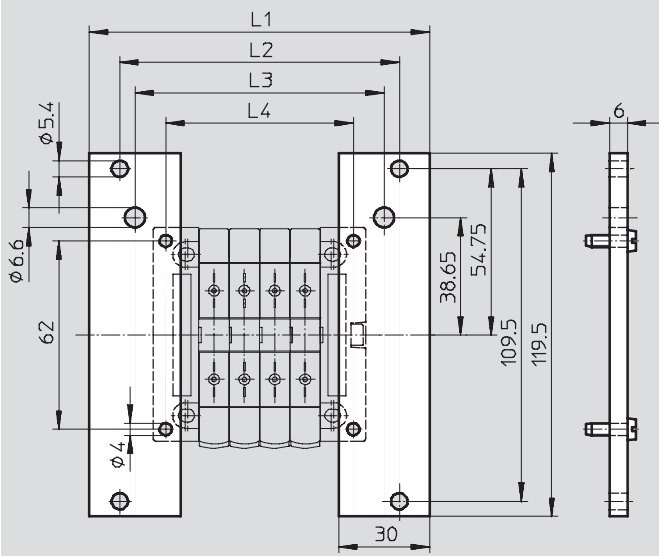

	2-fold	3-fold	4-fold	5-fold	6-fold	7-fold	8-fold
L1	92	102	112	122	132	142	152
L2	72	82	92	102	112	122	132
L3	62	72	82	92	102	112	122
L4	41.2	51.8	61.8	71.8	81.8	91.8	101.8

Valve terminals type 10 CPV10-EX-VI, Compact Performance

Technical data

Dimensions

Download CAD data → www.festo.com

Attachment CPV10-VI-BG-NRH-35 for H-rail mounting

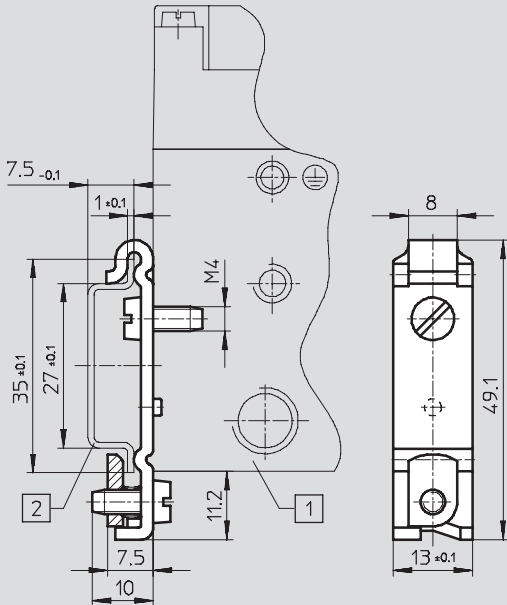

1 Valve terminal CPV10

2 H-rail to DIN EN 5022

Valve terminals type 10 CPV10-EX-VI, Compact Performance

Technical data

Dimensions

Download CAD data → www.festo.com

Pneumatic multiple connector plate

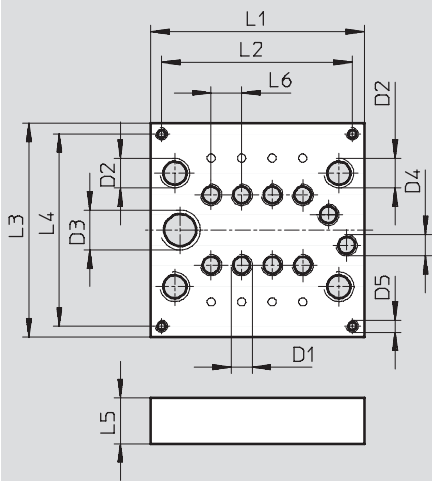

	L1	L2	L3	L4	L5	L6	D1	D2	D3	D4	D5
2-fold	49.5	42.5	70	63	15	10	M7	G $\frac{1}{8}$	G $\frac{1}{4}$	M7	M4
4-fold	69.5	62.5									
6-fold	89.5	82.5									
8-fold	109.5	102.5									

Pneumatic multiple connector plate with flange

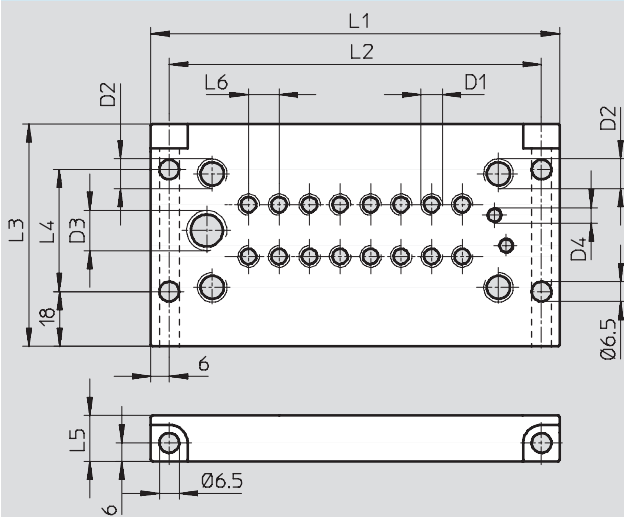

	L1	L2	L3	L4	L5	L6	D1	D2	D3	D4
2-fold	74	62	73	40	15	10	M7	G $\frac{1}{8}$	G $\frac{1}{4}$	M5
4-fold	94	82								
6-fold	114	102								
8-fold	134	122								

Valve terminals type 10 CPV10-EX-VI, Compact Performance

Technical data

Dimensions

Download CAD data → www.festo.com

Pneumatic multiple connector plate for control cabinet installation, without supply ports

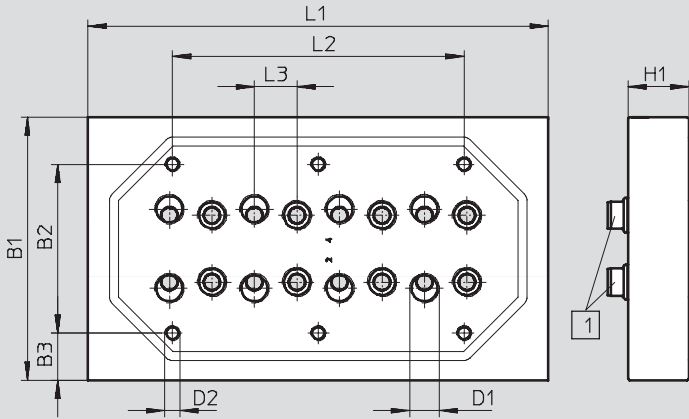

1 Seal

	L1	L2	L3	B1	B2	B3	D1	D2	H1
2-fold	49.5	-	10	70	40	15	M7	M5	10
4-fold	69.5	28							
6-fold	89.5	49							
8-fold	109.5	68							

Pneumatic multiple connector plate for control cabinet installation, with supply ports

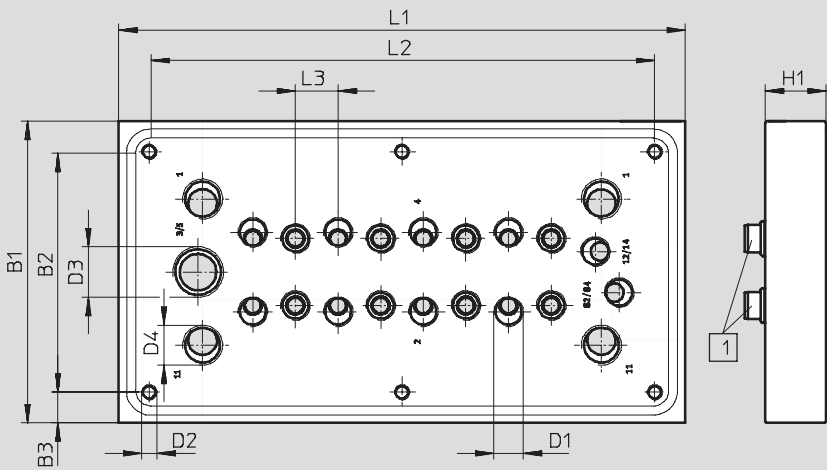

1 Seal

	L1	L2	L3	B1	B2	B3	D1	D2	D3	D4	H1
2-fold	82	62	10	84	64	10	M7	M5	G $\frac{1}{4}$	G $\frac{1}{8}$	15
4-fold	102	82									
6-fold	122	102									
8-fold	142	122									

Valve terminals type 10 CPV10-EX-VI, Compact Performance

Technical data

Dimensions

Download CAD data → www.festo.com

Valve kit for 5/3-way function

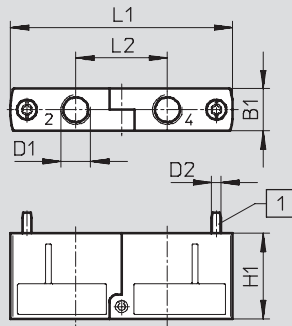

1 Mounting screws supplied loose

Type	B1	D1	D2	H1	L1	L2
CPV10-BS-5/3G-M7	9.9	M7	M2.5	22	55.8	23

Additional function – One-way flow control valve

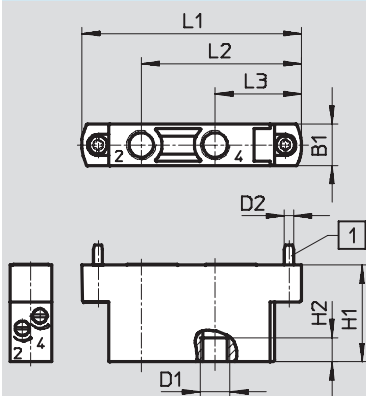

1 Mounting screws supplied loose

Type	B1	D1	D2	H1	H2	L1	L2	L3
CPV10-BS-2xGR...-M7	9.9	M7	M2.5	26	6	55.8	41.4	22.9
CPV10-BS-2xGRZ-V...-M7							-	-

Valve terminals type 10 CPV10-EX-VI, Compact Performance

Accessories

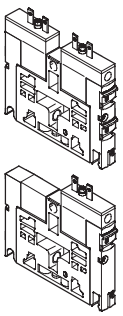
Ordering data				
	Code	Valve function	Type	Part No.
Individual valve slice, size 10				
	M	5/2-way single solenoid valve	CPV10-M1H-5LS-M7-B-EX	550 696
	J	5/2-way double solenoid valve	CPV10-M1H-5JS-M7-B-EX	550 697
	N	2x 3/2-way valve, normally open	CPV10-M1H-2x3-OLS-M7-B-EX	550 698
	C	2x 3/2-way valve, normally closed	CPV10-M1H-2x3-GLS-M7-B-EX	550 700
	H	2x 3/2-way valve, 1x normally open, 1x closed	CPV10-M1H-3OLS-3GLS-M7-B-EX	550 699
	D	2x 2/2-way valve, normally closed	CPV10-M1H-2x2-GLS-M7-B-EX	550 701
	I	2x 2/2-way valve, 1x normally open, 1x closed	CPV10-M1H-2OLS-2GLS-M7-B-EX	550 702

Valve terminals type 10 CPV10-EX-VI, Compact Performance



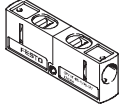
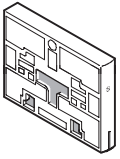
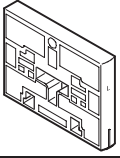
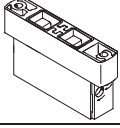
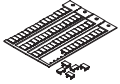



Accessories

Ordering data				
	Code	Designation	Type	Part No.
Function block				
	G	Valve kit for 5/3-way valve function, closed (in combination with valve slice C) for size 10	CPV10-BS-5/3G-M7	176 055
Separator plates				
	T	Separator plate, duct 1/11 closed	CPV10-DZP	161 369
	S	Separator plate, duct 1/11, 3/5 closed	CPV10-DZPR	178 678
Blanking plate				
	L	Blanking plate	CPV10-RZP	161 368
Additional functions for valve positions				
	P	One-way flow control valve, 2x supply air	CPV-10-BS-2xGRZZ-M7	184 140
	Q	One-way flow control valve, 2x exhaust air	CPV-10-BS-2xGRAZ-M7	184 141
Inscription labels				
	-	6x10 mm in frames, 64 pieces	IBS 6x10	18 576

Valve terminals type 10 CPV10-EX-VI, Compact Performance



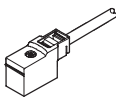

FESTO

Accessories

Ordering data					
	Code	Designation	Type	Part No.	
Attachment					
	H	Attachment for H-rail	CPV10/14-VI-BG-NRH-35	162 556	
	U	Attachment for wall mounting	CPV10/14-VI-BG-RWL-B	189 541	
	X	Attachment for individual connection	CPV10-VI-BG-ET200X	165 801	
Manual override					
	-	Locking clip (for manual override)	CPV10/14-HS	526 203	
	V	Locking clip (cover for manual override)	CPV10/14-HV	530 055	
Cable for individual connection, electrical					
	-	Plug socket with cable	0.5 m	KMYZ-4-0,5-B-EX	550 324
	-		2.5 m	KMYZ-4-2,5-B-EX	550 481
	-		5.0 m	KMYZ-4-5,0-B-EX	550 482
Plug socket for self-assembly					
	-	Plug socket	KMYZ-4-0,0-B-EX	550 806	

Valve terminals type 10 CPV10-EX-VI, Compact Performance

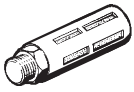
Accessories

Ordering data				
Designation		Type	Part No.	
Blanking plug				
	Blanking plug	B-M5	3 843	
		B-M7	174 309	
		B-1/8	3 568	
Push-in fitting				
	Push-in fitting	QS-1/8-8-I	153 015	
		QSM-M5-6-I	153 317	
		QSM-M7-6-I	153 321	
Silencer				
	Silencer	U-M5	4 645	
		U-1/4-B	6 842	
		U-3/8-B	6 843	
		UC-M7	161 418	
User documentation				
	CPV Pneumatics Description	German	P.BE-CPV10-EX-VI-DE	547 039
		English	P.BE-CPV10-EX-VI-EN	547 040
		French	P.BE-CPV10-EX-VI-FR	547 041
		Italian	P.BE-CPV10-EX-VI-IT	547 042
		Spanish	P.BE-CPV10-EX-VI-ES	547 043
		Swedish	P.BE-CPV10-EX-VI-SV	547 044