

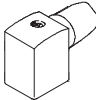







Plug sockets

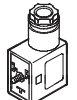
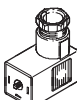
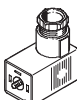

Product range overview



Design	Type	For solenoid coil (valves with solenoid coil)											→ Page	
		D	E	EB	F	N1	N2	V	Y	Z	ZB	ZC		
	MSSD-F MSSD-F-M16 MSSD-F-S-M16	-	-	-	■	-	-	-	-	-	-	-	-	2 / 7.2-13
	MSSD-C MSSD-C-M16 MSSD-C-S-M16	■	-	-	-	■	-	-	-	-	-	-	-	2 / 7.2-14
	MSSD-V MSSD-V-M16	-	-	-	-	-	-	■	-	-	-	-	-	2 / 7.2-16
	MSSD-E MSSD-E-M12	-	■	-	-	-	-	-	-	-	-	-	-	2 / 7.2-17
	MSSD-EB MSSD-EB-M12 MSSD-EB-S-M14	-	-	■	-	-	■	-	-	-	-	-	-	2 / 7.2-18
	MSSD-MY 	-	-	-	-	-	-	-	■	■	-	-	-	2 / 7.2-19
	MSSD-ZBZC	-	-	-	-	-	-	-	-	-	■	■	-	2 / 7.2-20

 To be discontinued

 Note
Allocation of solenoid coils to valve types → 2 / 7.1-1

Design	Type	For miniature valves	For proportional valves	For valves with central plug		→ Page
		MHA1...-PI/ MHP1...-PI	MPPE/MPPES	ISO 15 407-1	ISO 5599-1	
	PCBC	■	-	-	-	2 / 7.2-21
	MPPE-3-B	-	■	-	-	2 / 7.2-22
	SEA-M12-4WD-PG7	-	-	■	■	2 / 7.2-25

Plug sockets MSSD-F

Technical data



- Temperature range
-20 ... +115 °C
-25 ... +90 °C

- For valves with F solenoid coils
- Cable connection using clamping screws or insulation displacement technology



General technical data			
Type	MSSD-F	MSSD-F-M16	MSSD-F-S-M16
Cable connection	Clamping screws	Clamping screws	Insulation displacement technology
Perm. cable diameter [mm]	6 ... 8	6 ... 8	5.5 ... 8
Wire cross section [mm ²]	Max. 1.5	Max. 1.5	0.5 ... 1
Number of pins	3	3	3
Cable conduit fitting	Pg9	M16x1.5	-
Type of mounting	M3 central screw	M3 central screw	M3 central screw
Connection frequency	-	-	10
Protection class to EN 60529	IP65 (assembled)	IP65 (assembled)	IP67 (assembled)
Mounting position	Any	Any	Any
Ambient temperature [°C]	-25 ... +90	-20 ... +115	-25 ... +90
Product weight [g]	17	17	35
Materials	Polymer	Polymer	Polymer

Dimensions Download CAD data → www.festo.com/en/engineering

MSSD-F

1 Insert can be repositioned by 180°

MSSD-F-M16

1 Insert can be repositioned by 180°

MSSD-F-S-M16

2 Locknut M16x1
3 Connection side can be repositioned by 90°

With these plug sockets, instead of the cable being connected using individual clamping screws, the stranded wires are pressed into the patented insulation displacement contact when the screw is tightened.

- Strip the cable sheath
- Push it in
- Screw it in tightly
- And you're done!

Ordering data			Ordering data		
Part No.	Type	Cable connection	Part No.	Type	Cable connection
34 431	MSSD-F	Clamping screws	192 746	MSSD-F-S-M16	Insulation displacement technology
539 710	MSSD-F-M16				

Plug sockets MSSD-C

Technical data

FESTO

-  - Temperature range
-25 ... +90 °C
-20 ... +115 °C

- For valves with D and N1 solenoid coils
- Cable connection using clamping screws or insulation displacement technology



General technical data			
Type	MSSD-C	MSSD-C-M16	MSSD-C-S-M16
Cable connection	Clamping screws	Clamping screws	Insulation displacement technology
Perm. cable diameter [mm]	6 ... 8	6 ... 8	5.5 ... 8
Wire cross section [mm ²]	Max. 1.5	Max. 1.5	0.5 ... 1
Number of pins	3	3	3
Cable conduit fitting	Pg9	M16	M16
Type of mounting	M3 central screw	M3 central screw	M3 central screw
Connection frequency	–	50	10
Protection class to EN 60 529	IP65 (assembled)	IP65 (assembled)	IP67 (assembled)
Mounting position	Any	Any	Any
Product weight [g]	22		38
Materials	Polymer	Polyamide, reinforced	Polyamide
Note on materials	RoHS-compliant	–	–

Operating and environmental conditions			
Type	MSSD-C	MSSD-C-M16	MSSD-C-S-M16
Ambient temperature [°C]	-25 ... +90	-20 ... +115	-25 ... +90
CE-marking (see declaration of conformity)	in accordance with EU low-voltage directive	–	–
Certification	Germanischer Lloyd	–	–

Plug sockets MSSD-C

Technical data

Dimensions Download CAD data → www.festo.com/en/engineering

MSSD-C

1 Insert can be repositioned by 90°

MSSD-C-M16

1 Insert can be repositioned by 90°

MSSD-C-S-M16

With these plug sockets, instead of the cable being connected using individual clamping screws, the stranded wires are pressed into the patented insulation displacement contact when the screw is tightened.

- Strip the cable sheath
- Push it in
- Screw it in tightly
- And you're done!

2 Locknut M16x1
3 Connection side can be repositioned by 90°

Clamping screws		Insulation displacement technology	
Part No.	Type	Part No.	Type
34 583	MSSD-C	192 748	MSSD-C-S-M16
539 709	MSSD-C-M16		

Plug sockets MSSD-V

Technical data



- Temperature range
-25 ... +90 °C
-20 ... +115 °C

- For valves with V solenoid coils



General technical data		
Type	MSSD-V	MSSD-V-M16
Perm. cable diameter [mm]	6 ... 8	6 ... 8
Wire cross section [mm ²]	Max. 1.5	Max. 1.5
Number of pins	3	3
Cable conduit fitting	Pg9	M16x1.5
Type of mounting	M3 central screw	M3 central screw
Protection class to EN 60529	IP65 (assembled)	IP65 (assembled)
Mounting position	Any	Any
Ambient temperature [°C]	-25 ... +90	-20 ... +115
Product weight [g]	18	35
Materials	Polymer	Polymer

Dimensions

MSSD-V

1 Insert can be repositioned by 180°

Download CAD data → www.festo.com/en/engineering

MSSD-V-M16

1 Insert can be repositioned by 180°

Ordering data			
	Description	Part No.	Type
	Plug socket for valves with V solenoid coils	33 295	MSSD-V
		539 713	MSSD-V-M16

Plug sockets MSSD-E

Technical data



-  - Temperature range
-25 ... +120°C

• For valves with E solenoid coils



General technical data		
Type	MSSD-E	MSSD-E-M12
Perm. cable diameter [mm]	6 ... 8	4 ... 8
Wire cross section [mm ²]	Max. 0.75	Max. 0.75
Number of pins	3	3
Cable conduit fitting	Pg7	M12x1.5
Type of mounting	M3 central screw	M3 central screw
Protection class to EN 60529	IP65 (assembled)	IP65 (assembled)
Mounting position	Any	Any
Ambient temperature [°C]	-25 ... +120	-20 ... +115
Product weight [g]	8	11
Materials	Polymer	Polymer

Dimensions

Download CAD data → www.festo.com/en/engineering

MSSD-E

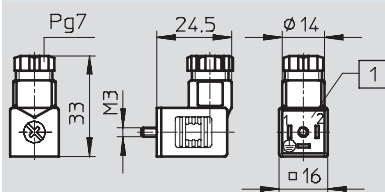

1 Insert can be repositioned by 90°

MSSD-E-M12

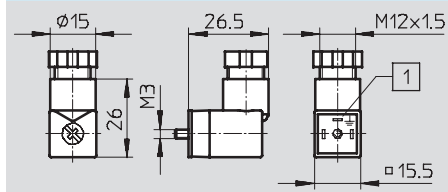

1 Insert can be repositioned by 90°

Ordering data

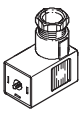
	Description	Part No.	Type
	Plug socket for valves with E solenoid coils	14 098	MSSD-E
		539 711	MSSD-E-M12

Plug sockets MSSD-EB

Technical data



- Temperature range
-45 ... +90°C
-40 ... +120°C

- For valves with EB and N2 solenoid coils



General technical data			
Type	MSSD-EB	MSSD-EB-M12	MSSD-EB-S-M14
Cable connection	Clamping screws	Clamping screws	Insulation displacement technology
Perm. cable diameter [mm]	6 ... 8	6 ... 8	4 ... 6
Wire cross section [mm ²]	Max. 0.75	Max. 1,5	0.25 ... 0.5
Number of pins	3	3	3
Cable conduit fitting	Pg7	M12	-
Type of mounting	M2.5 central screw	M2.5 central screw	M2.5 central screw
Connection frequency	-	50	10
Protection class to EN 60529	IP65 (assembled)	IP65 (assembled)	IP67 (assembled)
Mounting position	Any	Any	Any
Ambient temperature [°C]	-45 ... +90	-40 ... +125	-25 ... +90
Product weight [g]	11	11	17
Materials	Polymer	Polyamid	Polyamid

Valve accessories
Plug sockets

7.2

Dimensions Download CAD data → www.festo.com/en/engineering

MSSD-EB

1 Insert can be repositioned by 90°

MSSD-EB-M12

1 Insert can be repositioned by 90°

MSSD-EB-S-M14

1 Locknut M14x1
3 Connection side can be repositioned by 90°

With these plug sockets, instead of the cable being connected using individual clamping screws, the stranded wires are pressed into the patented insulation displacement contact when the screw is tightened.

- Strip the cable sheath
- Push it in
- Screw it in tightly
- And you're done!

Ordering data			
Part No.	Type	Cable connection	Part No. Type Cable connection
151 687	MSSD-EB	Clamping screws	192 745 MSSD-EB-S-M14
539 712	MSSD-EB-M12		Insulation displacement technology

Do not use for new designs!
 -  - Type to be discontinued

Plug sockets MSSD-MY

Technical data

FESTO

-  - Temperature range
 -25 ... +80°C

• For valves with Y and Z solenoid coils





General technical data		
Perm. cable diameter	[mm]	6 ... 8
Wire cross section	[mm ²]	Max. 0.3
Number of pins		2
Type of mounting		Clip
Protection class to EN 60 529		IP00
Mounting position		Any
Ambient temperature	[°C]	-25 ... +80
Product weight	[g]	2
Materials		Polymer

Assembly instructions for MSSD-MY and MSSD-MY-C

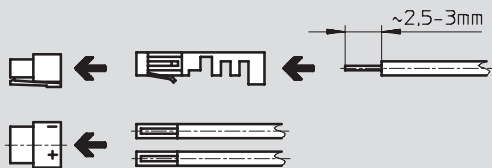
Download CAD data → www.festo.com/en/engineering



Ordering data			
	Description	Part No.	Type
	Plug socket for valves with Y and Z solenoid coils	34 345	MSSD-MY
	Crimp connectors for plug socket MSSD-MY	34 346	MSSD-MY-C

Plug sockets MSSD-ZBZC

Technical data



• Temperature range
-10 ... +50°C

• For valves with ZB and ZC solenoid coils



General technical data		
Wire cross section	[mm ²]	0.22 ... 0.34
Number of pins		2
Type of mounting		Self-tapping central screw
Protection class to EN 60 529		IP40 (assembled)
Mounting position		Any
Ambient temperature	[°C]	-10 ... +50
Product weight	[g]	11
Material		Polyamide

Valve accessories
Plug sockets

7.2

Dimensions Download CAD data → www.festo.com/en/engineering

- 1 Mounting screw
- 2 Inscription label
- 4 Connection pattern for ZB solenoid coil
- 5 Connection pattern for ZC solenoid coil

Ordering data			
	Description	Part No.	Type
	Plug socket for valves with ZB and ZC solenoid coils	185 521	MSSD-ZBZC

Soldering base PCBC

Technical data



-  - Temperature range
-40 ... +115°C

- For mounting miniature valves MHA1 and MHP1 on a PCB with plug connection underneath (-PI)

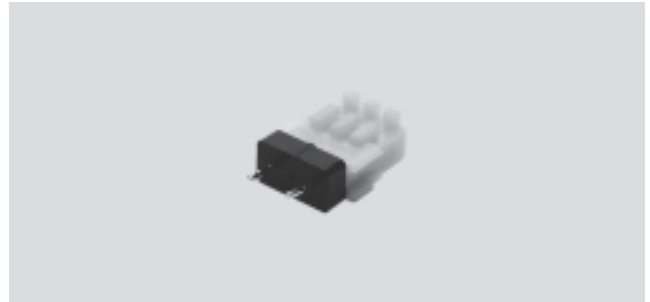

General technical data	
Number of pins	2
Type of mounting	Soldering base
Protection class to EN 60 529	IP40 (assembled)
Mounting position	Any
Ambient temperature [°C]	-40 ... +115
Product weight [g]	5
Materials	Polyamide

Dimensions Download CAD data → www.festo.com/en/engineering

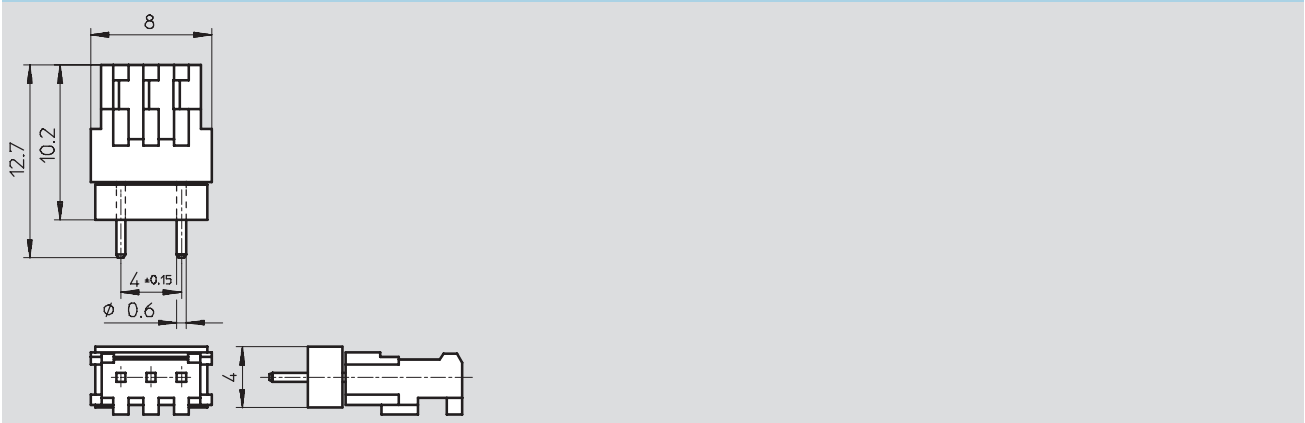

Ordering data				
	Description	Part No.	Type	PU ¹⁾
	Soldering base	197 261	PCBC-A-10	10
		197 262	PCBC-A-100	100

1) Packaging unit quantity

Plug sockets MPPE-3-B

Technical data



-  - Temperature range
-40 ... +85°C

- For proportional pressure regulators MPPE and MPPES





General technical data		
Wire cross section	[mm ²]	Max. 0.75
Number of pins		8
Type of mounting		Knurled locknut M16x0.75
Mounting position		Any
Ambient temperature	[°C]	-40 ... +85
Product weight	[g]	42

Valve accessories
Plug sockets

7.2

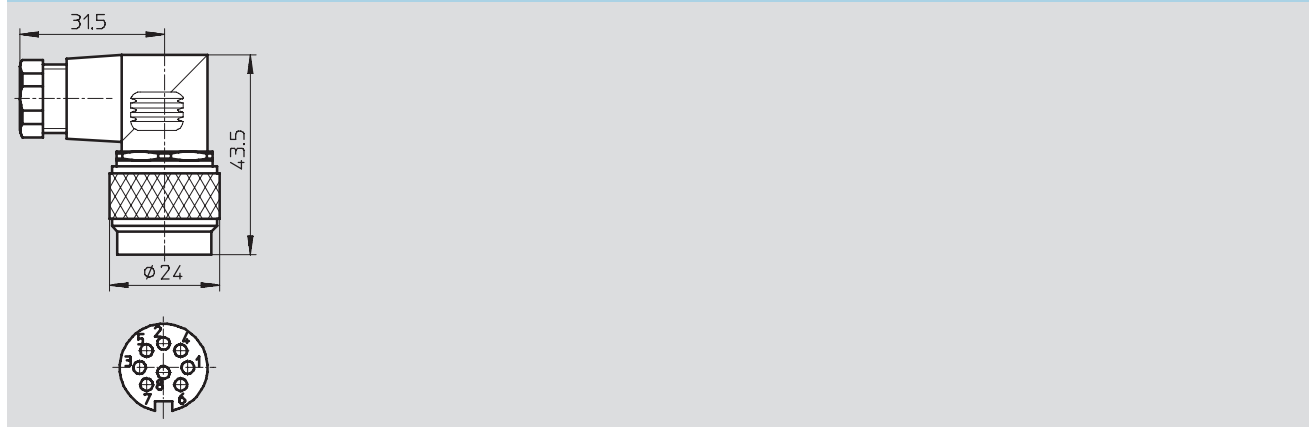
Dimensions Download CAD data → www.festo.com/en/engineering



Ordering data			
	Description	Part No.	Type
	Plug socket for proportional pressure regulators MPPE and MPPES	161 839	MPPE-3-B

Plug sockets with cable SIM

Technical data – M12x1, 4-pin



SIM-M12-4GD-5-PU

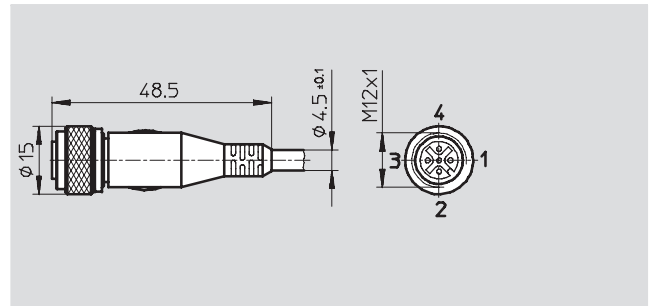

SIM-M12-4WD-5-PU

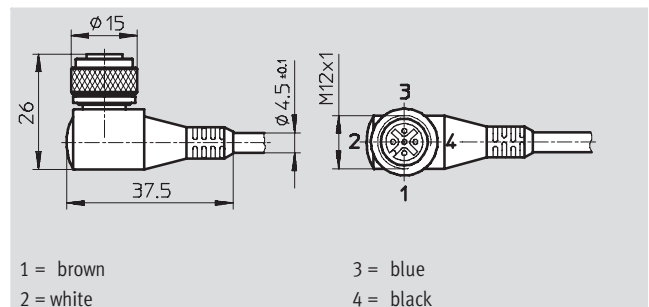

General technical data			
		SIM-M12-4...-5-PU	
Electrical data			
Electrical connection		Straight or angled socket, M12x1, 4-pin	
Current-carrying capacity	[A]	2.8	
Operating voltage range	AC	[V]	≤45
	DC	[V]	≤70
Protection class to EN 60 529		IP65/IP67	
Design			
Cable length	[m]	5	
Cable composition	[mm ²]	4x 0.25	
Wire ends		Tin-coated	
Ambient temperature			
Fixed cable installation	[°C]	-40 ... +70	
Flexible cable installation	[°C]	-5 ... +70	
Materials			
Cable sheath		Polyurethane	

Ordering data					
		Part No.	Type	Part No.	Type
Connection direction		In-line		Lateral	
Cable length [m]	5	164 259	SIM-M12-4GD-5-PU	164 258	SIM-M12-4WD-5-PU

Plug sockets SIE

Technical data



Straightsocket SIE-GD

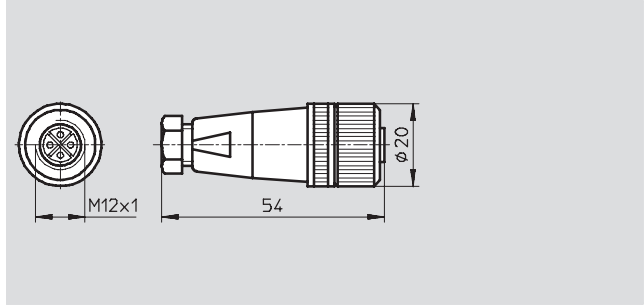

Angled plug socket SIE-WD-TR

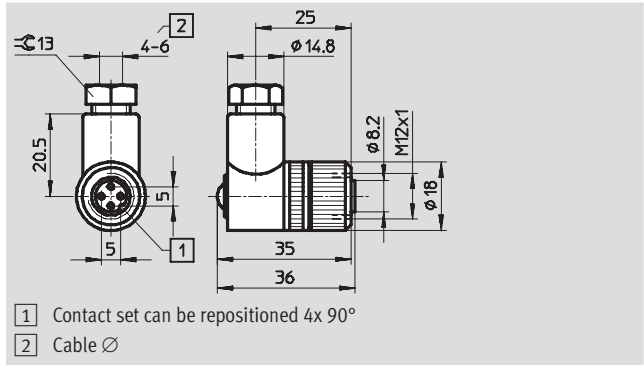

General technical data		
Connection direction	In-line	Lateral
Electrical data		
Electrical connection	Straight socket, M12x1, 4-pin	
Operating voltage range	AC [V]	≤125
	DC [V]	≤150
Current-carrying capacity	[A]	3
Cable connection	Screw terminal	
Perm. cable diameter	[mm]	4 ... 6
Max. wire cross section	[mm ²]	0.75
Ready status display	-	LED green (accessory)
Protection class to EN 60 529	IP67 (assembled)	
Ambient temperature	[°C]	-40 ... +85
Materials		
Housing	Polyamide	

Ordering data				
	Part No.	Type	Part No.	Type
Connection direction	In-line		Lateral	
Plug socket	18 494	SIE-GD	12 956	SIE-WD-TR
Ready status display	-		12 957	SIE-LP-LED-GR

Plug sockets SEA-M12-WD

Technical data

FESTO

-  - Temperature range
-40 ... +85°C

- For valves to ISO 15 407-1 (VDMA 24 563) and ISO 5599-1 with central plug M12x1



General technical data		
Perm. cable diameter	[mm]	4 ... 6
Wire cross section	[mm ²]	Max. 0.75
Number of pins		4
Cable conduit fitting		Pg7
Type of mounting		Knurled locknut M12x1
Protection class to EN 60 529		IP67 (assembled)
Mounting position		Any
Ambient temperature	[°C]	-40 ... +85
Product weight	[g]	30
Material	Housing	Polybutylene terephthalate
	Contacts	Tin-coated bronze

Dimensions Download CAD data → www.festo.com/en/engineering

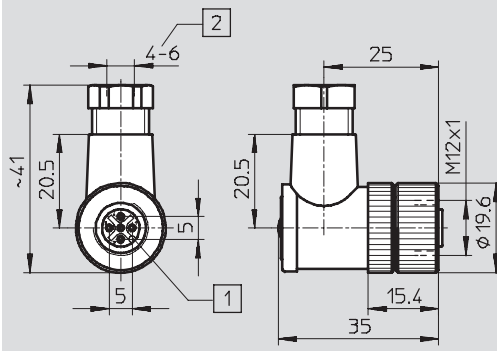

- 1 Contact set can be repositioned by 4x90°
- 2 Perm. cable diameter

Ordering data			
	Description	Part No.	Type
	Plug socket for valves to ISO 15 407-1 (VDMA 24 563) and ISO 5599-1 with central plug M12x1	185 498	SEA-M12-4WD-PG7

Plug sockets KMYZ-4

Technical data



- Temperature range
-10 ... +50 °C

- For use with intrinsically safe CPV valve terminals



General technical data	
Electrical connection	Angled socket, square design MSZB
Wire cross section [mm ²]	0.22 ... 0.34
Number of pins	2
Type of mounting	Self-tapping central screw
Protection class to EN 60529	IP40 (assembled)
Operating voltage range [V DC]	3 ... 36
Nominal operating voltage [V DC]	24
Mounting position	Any
Ambient temperature [°C]	-10 ... +50
Product weight [g]	6.5
Housing material	Polyamide
Note on material	Conforms to RoHS
Corrosion resistance class CRC ¹⁾	1
Certification	Germanischer Lloyd

1) Corrosion resistance class 1 to Festo standard 940 070
Components requiring low corrosion resistance. Transport and storage protection. Parts that do not have primarily decorative surface requirements, e.g. in internal areas that are not visible or behind covers.

Dimensions Download CAD data → www.festo.com/en/engineering

Technical drawing showing dimensions and callouts for the KMYZ-4 plug socket:

- 1: Mounting screw
- 2: Inscription label IBS-6x10
- 4: Pin allocations for ZB solenoid coil
- 5: Pin allocations for ZC solenoid coil

Dimensions shown in the drawing:

- Length: 25
- Height: 15
- Width: 9.8
- Mounting hole diameter: $\phi 4.3$
- Mounting hole depth: 3.2

Ordering data			
	Description	Part No.	Type
	Plug socket for use with intrinsically safe CPV valve terminals	550 806	KMYZ-4-0.0-B-EX