

Motor controllers SFC-LAC



- 1 - Type discontinued
Available up until 2011

Motor controllers SFC-LAC

Key features

FESTO

Hardware

- The motor controller SFC-LAC serves as a positioning controller and closed loop position controller
 - Available with or without control panel
 - Thanks to IP54 protection, the motor controller can be mounted close to the drive
- Parameter assignment via:
- Control panel:
 - suitable for simple position sequences
 - FCT (Festo Configuration Tool) configuration package:
 - with RS 232 interface
 - Windows-based PC user interface, Festo Configuration Tool
- Easy actuation via:
- I/O interface
 - Profibus
 - CANopen, “Interpolated position mode” included
 - DeviceNet



For controlling

linear module HME



FHPP – Festo Handling and Positioning Profile

Optimised data profile

Festo has developed an optimised data profile, the “Festo Handling and Positioning Profile (FHPP)”, that is tailored to the target applications for handling and positioning tasks.

The FHPP data profile permits the actuation of Festo motor controllers, using a fieldbus interface, via standardised control and status bytes.

The following are defined, among others:

- Operating modes
- I/O data structure
- Parameter objects
- Sequence control

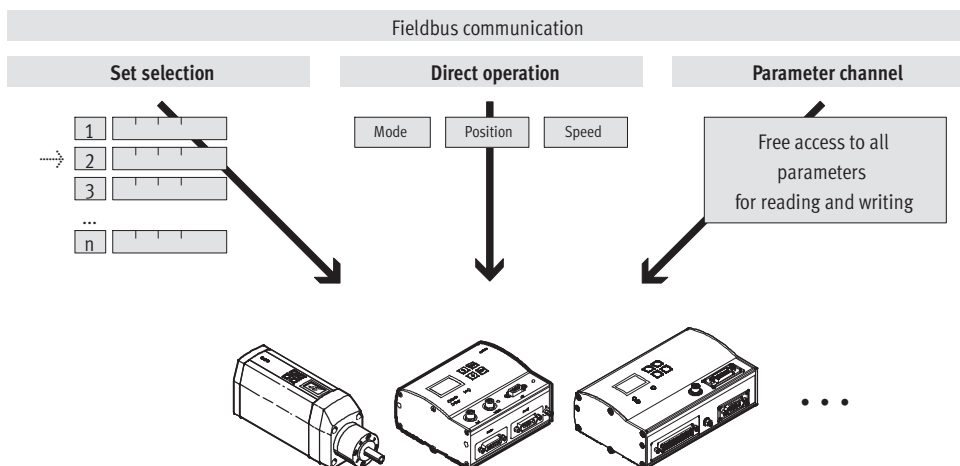
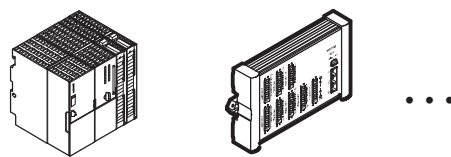

PROFIBUS®, DeviceNet®, CANopen® is a registered trademark of its respective trademark holder in certain countries.

Motor controllers SFC-LAC

Key features

FESTO

FCT software – Festo Configuration Tool

Software platform for electric drives from Festo

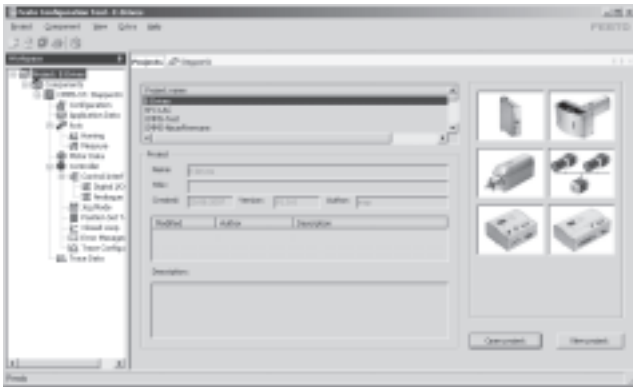

- All drives in a system can be managed and archived in a common project
- Project and data management for all supported device types
- Simple to use thanks to graphically-supported parameter entry
- Universal mode of operation for all drives
- Working offline at your desk or online at the machine

Mechanical reference positions and limit positions

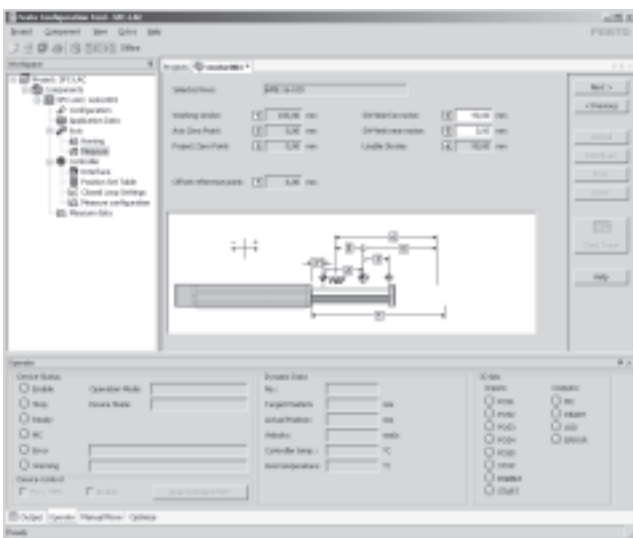

- Reference positions can be either edited or taught in
- Flexible adaptation to installation conditions
- Settings are displayed clearly

Position set table



- 31 position sets ensure flexibility in positioning
- Absolute or relative positioning values can be used
- The following parameters can be set flexibly for each application:
 - Position
 - Speed
 - Acceleration
 - Braking ramps
- Complete function test

- 1 - Type discontinued
Available up until 2011

Motor controllers SFC-LAC

Type codes

FESTO

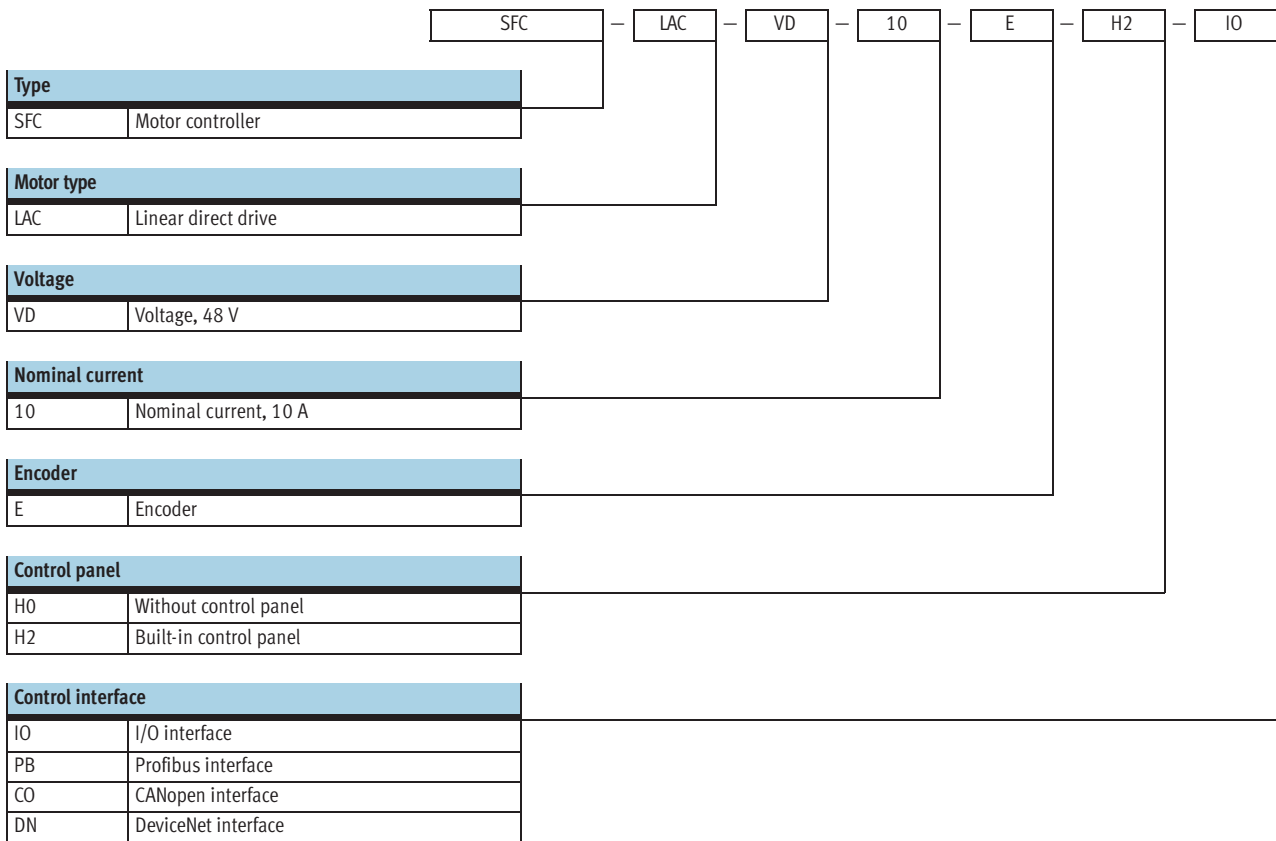

Motor controllers SFC-LAC

Technical data

Fieldbus interfaces



General technical data				
Type	SFC-...-IO	SFC-...-PB	SFC-...-CO	SFC-...-DN
Operating mode	Adaptive status controller			
Position sensor	Encoder			
Encoder input	CAN bus			
Display (optional)	Interface with full-text display via graphic LCD display (128 x 64 pixels)			
Control elements (optional)	4 keys			
Interface	I/O interface for 31 position sets and homing	Profibus DP	CANopen	DeviceNet
Number of digital logic inputs	8	-		
Number of digital logic outputs	4	-		
Bus terminating resistor	-	Not integrated in the device		
Communication profile	-	DP-V0/V1 / FHPP	DS301 / FHPP	FHPP
	-	Step7 functional modules	DS301, DSP402	Device type 0C _h
Max. fieldbus baud rate [Mbit/s]	-	12	1	0.5
Mains filter	Integrated			
Type of mounting	H-rail, wall or surface bracket			
Product weight [g]	1,200			

Electrical data		
General		
Rated output [VA]	480	
Parameterisation interface	RS232; 38,400 baud	
Max. intermediate circuit voltage [V DC]	48	
Peak power [VA]	960	
Peak current per phase, effective [A]	15	
Load supply		
Nominal voltage [V DC]	48 +5/-10%	
Nominal current [A]	10	
Peak current [A]	20	
Logic supply		
Nominal voltage [V DC]	24 ±10%	
Nominal current [A]	0.5	
Peak current [A]	0.8	
Max. current per output (digital logic outputs) [A]	0.5	

- 1 - Type discontinued
Available up until 2011

Motor controllers SFC-LAC

Technical data

FESTO

Operating and environmental conditions				
Type	SFC-...-IO	SFC-...-PB	SFC-...-CO	SFC-...-DN
Digital logic outputs	Electrically isolated	-	-	-
Logic inputs	Electrically isolated	-	-	-
Logic input specification	IEC 61131	-	-	-
Mains filter	Integrated			
Protection class	IP54			
Vibration resistance	To DIN EN 60068-2-6			
Shock resistance	To DIN EN 60068-2-27			
Protective function	I ² t monitoring			
	Current monitoring			
	Voltage failure detection			
	Lag error monitoring			
	Software end position detection			
CE mark (see declaration of conformity)	In accordance with EU EMC directive			
Ambient temperature	[°C]	0 ... +40		
Relative air humidity	[%]	0 ... 95 (non-condensing)		
Certification	C-Tick			

Pin allocation

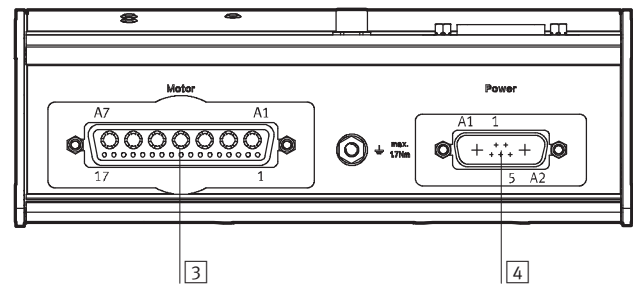
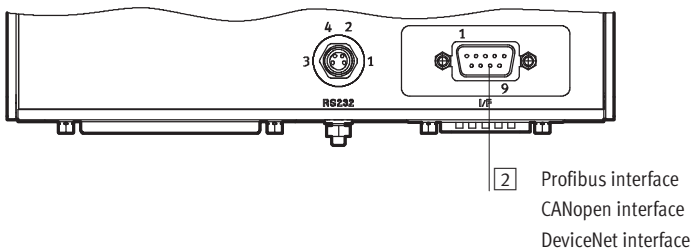
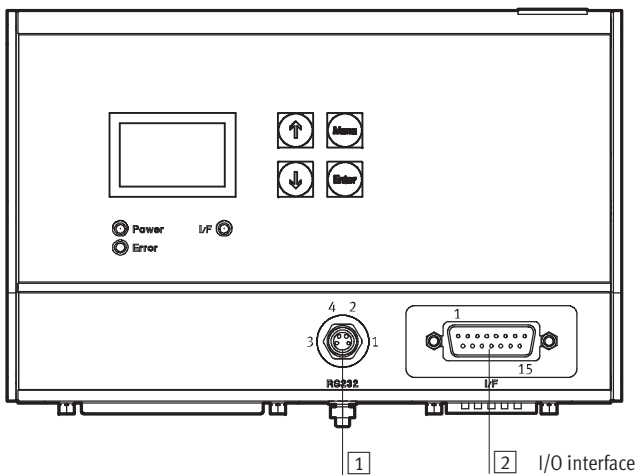

Motor controllers SFC-LAC

Technical data

1 RS232 interface, 4-pin M8 socket	
Pin	Function
1	0 V
2	Transmitted data (TxD)
3	Received data (RxD)
4	–

2 I/O interface, 15-pin Sub-D plug	
Pin	Function
1	24 V (supply for output)
2	Position set coding, bit 1
3	Position set coding, bit 2
4	Position set coding, bit 3
5	Position set coding, bit 4
6	Position set coding, bit 5
7	Stop bit
8	0 V
9	Enable bit
10	Start bit
11	MC
12	Ready
13	Acknowledge
14	Error
15	0 V

2 Profibus interface, 9-pin Sub-D socket	
Pin	Function
1	–
2	–
3	RxD/TxD-P
4	CNTR-P
5	DGND
6	VP
7	–
8	RxD/TxD-N
9	–

2 CANopen interface, 9-pin Sub-D plug	
Pin	Function
1	–
2	CAN_L
3	CAN_GND
4	–
5	CAN_SHLD
6	CAN_V–
7	CAN_H
8	–
9	CAN_V+

2 DeviceNet interface, 9-pin Sub-D plug	
Pin	Function
1	–
2	CAN_L
3	CAN_GND
4	–
5	CAN_SHLD
6	CAN_V–
7	CAN_H
8	–
9	CAN_V+

3 Motor interface, 24-pin plug connector	
Pin	Function
A1	String 1+
A2	String 1–
A3	String 2+
A4	0 V
A5	String 2–
A6	String 3+
A7	String 3–
1	24 V
2	–
3	–
4	CAN-H line
5	CAN-L line
6	CAN ground
7	–
8	–
9	–
10	–
11	–
12	–
13	–
14	–
15	–
16	0 V
17	–

4 Power supply, 7-pin plug	
Pin	Function
A1	48 V (load)
A2	0 V (load)
1	24 V (logic)
2	0 V (logic)
3	–
4	PE
5	–

- 1 - Type discontinued
Available up until 2011

Motor controllers SFC-LAC

Technical data

FESTO

Dimensions

Download CAD data → www.festo.com

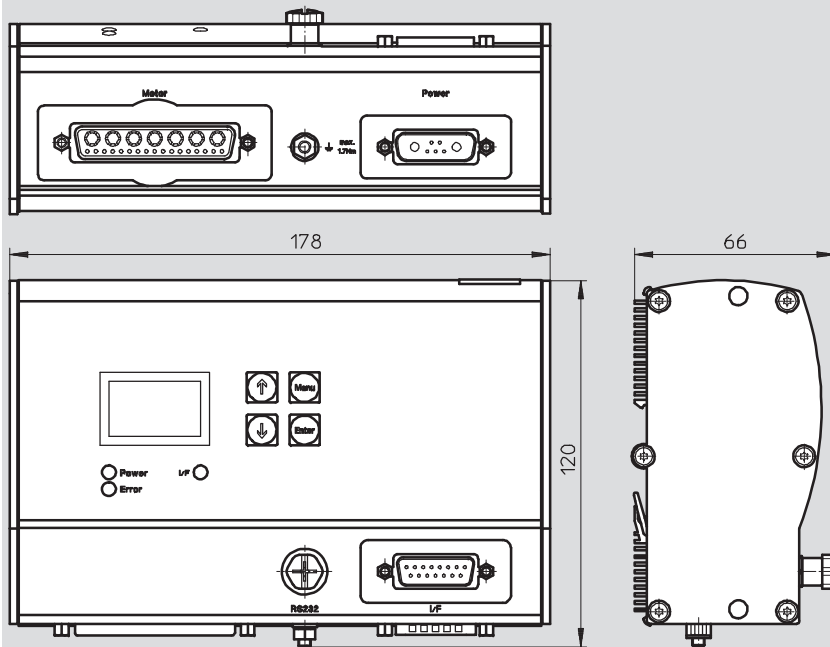

Ordering data

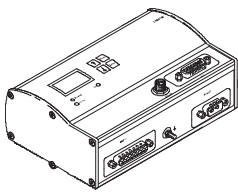
Motor controller	Brief description	Part No.	Type
	With I/O interface		
	Without control panel	540 038	SFC-LAC-VD-10-E-H0-IO
	With control panel	540 039	SFC-LAC-VD-10-E-H2-IO
	With Profibus interface		
	Without control panel	540 631	SFC-LAC-VD-10-E-H0-PB
	With control panel	540 632	SFC-LAC-VD-10-E-H2-PB
	With CANopen interface		
	Without control panel	540 633	SFC-LAC-VD-10-E-H0-CO
	With control panel	540 634	SFC-LAC-VD-10-E-H2-CO
	With DeviceNet interface		
	Without control panel	552 346	SFC-LAC-VD-10-E-H0-DN
	With control panel	552 347	SFC-LAC-VD-10-E-H2-DN

Motor controllers SFC-LAC

Accessories

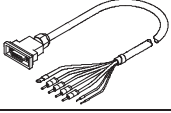
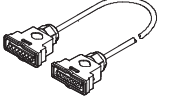
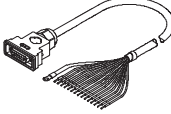
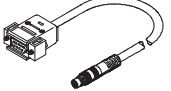
Ordering data – Cables				
	Brief description	Cable length [m]	Part No.	Type
	Supply cable, for connecting load and logic supply	2.5	538 914	KPWR-MC-1-SUB-15HC-2,5
		5	538 915	KPWR-MC-1-SUB-15HC-5
		10	538 916	KPWR-MC-1-SUB-15HC-10
	Motor cable, for connecting motor and controller	2.5	539 489	KMTR-LAC-S50HC-S50HC-2,5
		5	539 490	KMTR-LAC-S50HC-S50HC-5
		10	539 491	KMTR-LAC-S50HC-S50HC-10
	Control cable, for I/O interface to any controller	2.5	538 919	KES-MC-1-SUB-15-2,5
		5	538 920	KES-MC-1-SUB-15-5
		10	538 921	KES-MC-1-SUB-15-10
	Programming cable, for parameterisation and commissioning via RS232 interface using FCT software	2.5	537 926	KDI-MC-M8-SUB-9-2,5

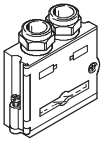
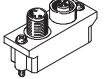
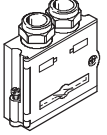
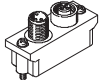
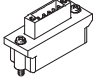
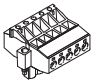
Ordering data – Plugs				
	Brief description	Part No.	Type	
Plug for Profibus				
	<ul style="list-style-type: none"> – 9-pin Sub-D connection – Bus terminating resistor integrated – Position of DIL switch can be read externally – IP65 	532 216	FBS-SUB-9-GS-DP-B	
Bus connection adapter for Profibus				
	<ul style="list-style-type: none"> – 9-pin Sub-D plug to 5-pin round plug/socket M12 – Bus terminating resistor must be connected externally 	533 118	FBA-2-M12-5POL-RK	
Plug for CANopen and DeviceNet				
	<ul style="list-style-type: none"> – 9-pin Sub-D connection – Bus terminating resistor integrated – Position of DIL switch can be read externally – IP65 	532 219	FBS-SUB-9-BU-2x5POL-B	
Bus connection adapter for CANopen and DeviceNet				
	<ul style="list-style-type: none"> – 9-pin Sub-D plug to 5-pin round plug/socket M12 – Bus terminating resistor must be connected externally 	525 632	FBA-2-M12-5POL	
	<ul style="list-style-type: none"> – 9-pin Sub-D plug to 5-pin strip – Bus terminating resistor must be connected externally 	525 634	FBA-1-SL-5POL	
	– 5-pin terminal strip for connecting the fieldbus cable to the bus connection adapter FBA-1-SL-5POL	525 635	FBSD-KL-2x5POL	

- 1 - Type discontinued
Available up until 2011

Motor controllers SFC-LAC

Accessories

FESTO

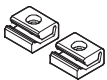
Ordering data – Central support		
	Brief description	Part No. Type
Central support		
	For mounting the controller	160 909 MUP-8/12

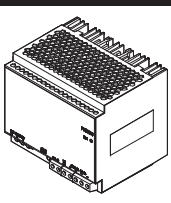
Ordering data – Power supply units					
	Brief description	Input voltage range [V AC]	Nominal output voltage [V DC]	Nominal output current [A]	Part No. Type
	Power supply for motor controller	100 ... 240	48	5	542 403 SVG-1/230VAC-48VDC-5A
		100 ... 240	48	10	542 404 SVG-1/230VAC-48VDC-10A
		400 ... 500	48	20	542 405 SVG-3/400VAC-48VDC-20A

Ordering data – Documentation and software		
	Brief description	Part No. Type
	Operating package contains: – CD-ROM – with user documentation for SFC-LAC, in the languages de, en, es, fr, it, sv – with FCT (Festo Configuration Tool) configuration software, in the languages de, en – Brief description This operating package is included in the scope of delivery.	542 004 P.BP-SFC-LAC

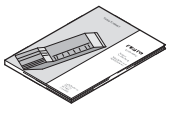
Ordering data – Documentation ¹⁾						
	Language	Part No.	Type	Part No.	Type	
			For I/O interface		For Profibus interface	
		DE	540 547	P.BE-SFC-LAC-IO-DE	540 649	P.BE-SFC-LAC-PB-DE
		EN	540 548	P.BE-SFC-LAC-IO-EN	540 650	P.BE-SFC-LAC-PB-EN
		ES	540 549	P.BE-SFC-LAC-IO-ES	540 651	P.BE-SFC-LAC-PB-ES
		FR	540 550	P.BE-SFC-LAC-IO-FR	540 652	P.BE-SFC-LAC-PB-FR
		IT	540 551	P.BE-SFC-LAC-IO-IT	540 653	P.BE-SFC-LAC-PB-IT
		SV	540 552	P.BE-SFC-LAC-IO-SV	540 654	P.BE-SFC-LAC-PB-SV
				For CANopen interface		For DeviceNet interface
		DE	540 655	P.BE-SFC-LAC-CO-DE	555 886	P.BE-SFC-LAC-DN-DE
		EN	540 656	P.BE-SFC-LAC-CO-EN	555 887	P.BE-SFC-LAC-DN-EN
		ES	540 657	P.BE-SFC-LAC-CO-ES	555 888	P.BE-SFC-LAC-DN-ES
		FR	540 658	P.BE-SFC-LAC-CO-FR	555 889	P.BE-SFC-LAC-DN-FR
		IT	540 659	P.BE-SFC-LAC-CO-IT	555 890	P.BE-SFC-LAC-DN-IT
		SV	540 660	P.BE-SFC-LAC-CO-SV	555 891	P.BE-SFC-LAC-DN-SV

1) User documentation in paper form is not included in the scope of delivery