

## Coupling sockets/quick coupling plugs

**FESTO**



Festo Core Range  
Solves the majority of your automation tasks

Worldwide:  
Simply good:  
Fast:

Quickest delivery – wherever, whenever  
Expected high Festo quality  
Easy and fast to select

With the Festo Core Range, we have selected the most important products and functions from our broad product catalogue, and added the quickest delivery.

The Core Range offers you the best value for your automation tasks.

Just look  
for the  
star!

## Key features

### Operating mode

Plug-in coupling with coupling socket KD and quick coupling plug KS, shut off on one or both ends

#### Coupling

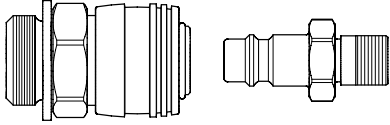

Push the plug into the socket to lock the coupling.  
The plug automatically engages with an audible click when in a specific position.

#### Decoupling

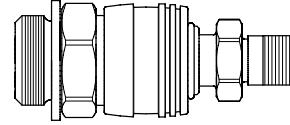

To unlock, push the releasing sleeve.

When removing the quick coupling plug, it is important to hold it until it is fully exhausted.

## Key features

## Operating mode

Safety coupling with coupling socket NPHS-D6-M and quick coupling plug NPHS-S6

## Coupling

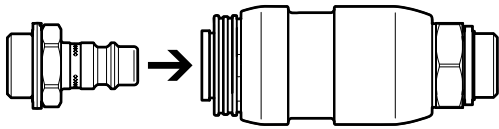

Push the plug into the socket to lock the coupling. The plug automatically engages with an audible click when in a specific position.

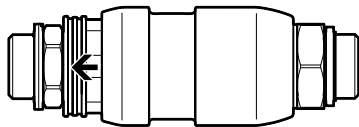

When the plug is engaged, the releasing sleeve shifts slightly in the direction of the plug. This releases the locking mechanism between the releasing sleeve and the sliding sleeve. The sliding sleeve can now be actuated.

## Pressurisation

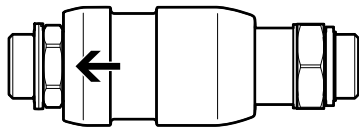

To pressurise, push the sliding sleeve in the direction of the plug.

## Exhausting

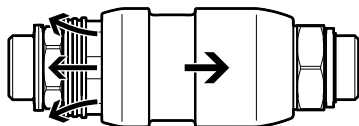

To exhaust, push the sliding sleeve in the direction of the thread on the coupling socket. The air from the plug and the components connected to it can escape. The air at the coupling end is shut off. The releasing sleeve can now be accessed.

## Decoupling

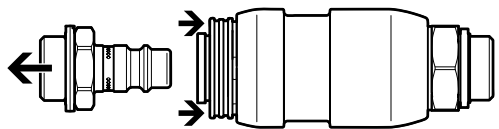

Unlock the plug fully by pushing the releasing sleeve. The plug should only be removed after all the air has been exhausted. With the plug removed, the two sleeves cannot slide or be pushed.

 **Note**

Pressurise or exhaust the coupling to a maximum of 10 bar only. Hearing protection is recommended, especially at higher operating pressures.

Safety coupling with coupling socket NPHS-D6-P and quick coupling plug NPHS-S6

## Coupling

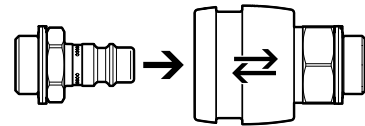

Push the plug into the socket to lock the coupling. The plug automatically engages with an audible click when in a specific position. During this process, the releasing sleeve moves briefly back and then forward again.

## Exhausting

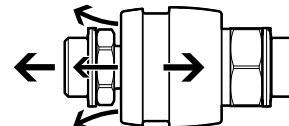

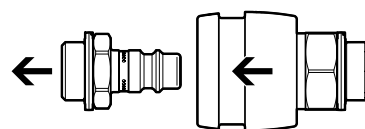

To exhaust, first push the releasing sleeve in the direction of the thread on the coupling socket. This releases the pin locking mechanism of the coupling. The plug moves approx. 5 mm out of the coupling and is held in this position by the ball locking mechanism of the coupling. The air from the plug and the components connected to it can escape. The air at the coupling end is shut off.

## Decoupling

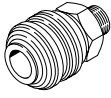

Next, release the plug from the ball locking mechanism by pulling the releasing sleeve. This releases the plug completely so that it can be removed from the socket. The plug should only be removed after all the air has been exhausted.

Product range overview

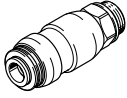
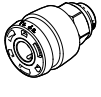
Function	Version	Type	Brief description	Standard nominal flow rate [l/min]	Nominal size [mm]	→ Page/Internet
Plug-in coupling	<b>Shut off at one end</b>					
		KD1/KS1	For standard applications, without safety function	44	1.5	6
		KD2/KS2		68 ... 135	2 ... 2.9	8
		KD3/KS3		158 ... 666	2.9 ... 5	10
		KD4/KS4		252 ... 1350	2.9 ... 10	12
	<b>Shut off at both ends</b>					
	KD3-...-R/ KS3-...-R	Both ends are sealed after unlocking	563	4.2 ... 5	16	
	KD4-...-R/ KS4-...-R		765	8	16	
Safety coupling	<b>Shut off at one end</b>					
		NPHS-D6-M/ NPHS-S6	Exhaust the air at the plug end by sliding the sliding sleeve and then unlocking the coupling	1750 ... 2100	5.5 ... 10	18
		NPHS-D6-P/ NPHS-S6	Exhaust the air at the plug end by pushing the releasing sleeve and then unlocking the coupling	875 ... 2083	5 ... 11	18
<b>Coupling/tubing combination options</b>						
Tubing		Coupling socket/plug				
		KD1/KS1	KD2/KS2	KD3/KS3	KD4/KS4	NPHS-D6/NPHS-S6
With standard I.D.	<b>Polyurethane</b>					
	PU-9	–	–	–	■	■
With standard O.D.	<b>Polyurethane</b>					
	PUN-3	■	–	–	–	–
	PUN-4	–	■	–	–	–
	PUN-6	–	■	■	■	–
	PUN-8	–	–	■	■	–
	<b>Polyamide</b>					
	PAN-4	–	■	–	–	–
	PAN-6	–	■	■	■	–
	PAN-8	–	–	■	■	–

## Product range overview



Coupling socket/plug combination options										
Connection	Size 1		Size 2		Size 3 <sup>1)</sup>		Size 4 <sup>1)</sup>		Size: 6	
	Socket KD1	Plug KS1	Socket KD2	Plug KS2	Socket KD3	Plug KS3	Socket KD4	Plug KS4	Socket NPHS-D6	Plug NPHS-S6
<b>Male thread</b>										
M3	■	–	–	–	–	–	–	–	–	–
M5	–	–	■	■	–	–	–	–	–	–
G1/8	–	–	–	–	■	■	–	–	■	■
G1/4	–	–	–	–	■	■	■	■	■	■
G3/8	–	–	–	–	–	–	■	■	■	■
G1/2	–	–	–	–	–	–	■	■	■	■
<b>Female thread</b>										
M5	–	–	■	■	–	–	–	–	–	–
G1/8	–	–	–	–	■	■	–	–	–	–
G1/4	–	–	–	–	■	■	■	■	■	■
G3/8	–	–	–	–	–	–	■	■	■	■
G1/2	–	–	–	–	–	–	■	■	■	■
<b>Quick connector with union nut</b>										
CK-3	–	–	■	■	–	–	–	–	–	–
CK-4	–	–	■	■	■	■	–	■	–	–
CK-6	–	–	–	–	■	■	■	■	–	–
CK-9	–	–	–	–	–	–	■	■	–	–
<b>Barbed fitting</b>										
CN-2	–	■	–	–	–	–	–	–	–	–
N-6	–	–	–	–	–	–	–	■	–	–
N-9	–	–	–	–	–	–	■	■	■	■

1) Coupling socket/quick coupling plug, shut-off at both ends: KD3-...-A-R thread G1/8 only, KD4-...-A-R thread G1/4 only

# Coupling sockets/quick coupling plugs KD/KS, shut off at one end

## Datasheet

### Plug-in coupling KD1/KS1

-  - Flow rate  
44 l/min
-  - Nominal size  
1.5 mm



General technical data		
Pneumatic connection 1	Coupling socket KD1	Quick coupling plug KS1
	Male thread	Barbed fitting
	M3	CN-2
Nominal size	[mm] 1.5	1.5
Nominal tightening torque	[Nm] 0.6 ±10%	-
Product weight	[g] 2.9	0.4

Standard nominal flow rate $q_{nN}^{1)}$ [l/min]		
Coupling socket/quick coupling plug combination	Coupling socket KD1	
	Male thread	
	M3	
<b>Quick coupling plug KS1</b>		
Barbed fitting	CN-2	44

1) Measured at  $p_1 = 6$  bar and  $\Delta p = 1$  bar

Operating and environmental conditions		
Operating pressure for entire temperature range	[bar]	-0.95 ... +12
Operating medium		Compressed air to ISO 8573-1:2010 [7:-:-]
Note on the operating/pilot medium		Lubricated operation possible
Ambient temperature	[°C]	-10 ... +60
Corrosion resistance class CRC <sup>1)</sup>		1 - Low corrosion stress

1) More information [www.festo.com/x/topic/crc](http://www.festo.com/x/topic/crc)

Materials		
	Coupling socket KD1	Quick coupling plug KS1
Housing	Nickel-plated brass	Nickel-plated brass
Releasing sleeve	Nickel-plated brass	-
LABS (PWIS) conformity	VDMA24364-B1/B2-L	

## Datasheet

Download CAD data → [www.festo.com](http://www.festo.com)

## Dimensions

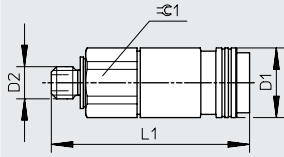
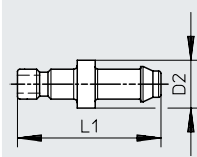
Coupling socket  
Male threadQuick coupling plug  
Barbed fitting

## Insertion depth

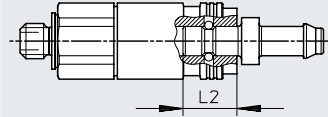

Connection	D1 ∅	D2	L1	L2	±0.1
<b>Male thread</b>					
M3	6.5	M3	18.5	4.6	6
<b>Barbed fitting</b>					
CN-2	-	4	12	4.6	-

## Ordering data

Connection

Coupling socket

Quick coupling plug

Part no.

Type

Part no.

Type

## Male thread

M3	151995	KD1-M3-A		-	
----	--------	----------	--	---	--

## Barbed fitting



CN-2	-		151996	KS1-CN-2	
------	---	--	--------	----------	--

## Datasheet

### Plug-in coupling KD2/KS2

 **Note**

All coupling sockets of the same size are compatible with all plugs of this size.

-  - Flow rate  
68 ... 135 l/min
-  - Nominal size  
2 ... 2.9 mm



#### General technical data – Coupling socket KD2

Pneumatic connection 1	Male thread	Female thread	Quick connector	
	M5	M5	CK-3	CK-4
Nominal size [mm]	2.4	2.7	2	2.9
Nominal tightening torque [Nm]	0.85 ±15%		–	
Product weight [g]	10	12	11	16

#### General technical data – Quick coupling plug KS2

Pneumatic connection 1	Male thread	Female thread	Quick connector	
	M5	M5	CK-3	CK-4
Nominal size [mm]	2.4	2.7	2	2.7
Nominal tightening torque [Nm]	0.85 ±15%		–	
Product weight [g]	5	5	4	11

#### Standard nominal flow rate $q_{nN}^{1)}$ [l/min]

Coupling socket/quick coupling plug combination	Coupling socket KD2				
	Male thread	Female thread	Quick connector		
	M5	M5	CK-3	CK-4	
<b>Quick coupling plug KS2</b>					
Male thread	M5	126	133	85	129
Female thread	M5	131	135	88	130
Quick connector	CK-3	83	84	68	82
	CK-4	120	126	86	123

1) Measured at  $p_1 = 6$  bar and  $\Delta p = 1$  bar

#### Operating and environmental conditions

Operating pressure for entire temperature range [bar]	–0.95 ... +12
Operating medium	Compressed air to ISO 8573-1:2010 [7:–:–]
Note on the operating/pilot medium	Lubricated operation possible
Ambient temperature [°C]	–10 ... +60
Corrosion resistance class CRC <sup>1)</sup>	1 - Low corrosion stress

1) More information [www.festo.com/x/topic/crc](http://www.festo.com/x/topic/crc)

#### Materials

	Coupling socket KD2	Quick coupling plug KS2
Housing	Nickel-plated brass	Nickel-plated brass
Releasing sleeve	Nickel-plated brass	–
Note on materials	RoHS-compliant	
LABS (PWIS) conformity	VDMA24364-B1/B2-L	



## Datasheet

## Dimensions – Coupling socket

Download CAD data → [www.festo.com](http://www.festo.com)

## Male thread

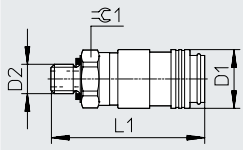

## Female thread

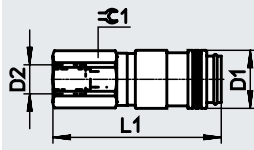

## Quick connector

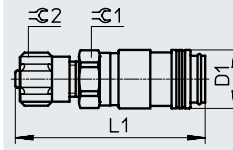

Connection	D1 ∅	D2	L1	∅ 1	∅ 2
<b>Male thread</b>					
M5	10	M5	26.25	9	–
<b>Female thread</b>					
M5	10	M5	29.05	9	–
<b>Quick connector with union nut</b>					
CK-3	10	–	32.55	9	8
CK-4			35.75	11	12

## Dimensions – Quick coupling plug

Download CAD data → [www.festo.com](http://www.festo.com)

## Male thread

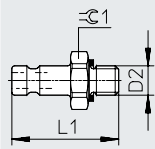

## Female thread

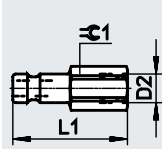

## Quick connector

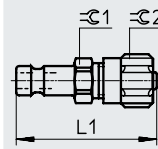

## Insertion depth

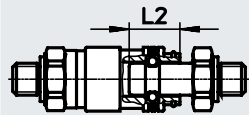

Connection	D1 ∅	D2	L1	L2	∅ 1	∅ 2
<b>Male thread</b>						
M5	10	M5	18.2	7.95	9	–
<b>Female thread</b>						
M5	10	M5	20	7.95	7	–
<b>Quick connector with union nut</b>						
CK-3	10	–	24	7.95	7	8
CK-4			27.2		11	12

## Ordering data

Connection	Coupling socket		Quick coupling plug	
	Part no.	Type	Part no.	Type
<b>Male thread</b>				
M5	4087	KD2-M5-A	531658	KS2-M5-A
<b>Female thread</b>				
M5	531620	KD2-M5-I	531660	KS2-M5-I
<b>Quick connector with union nut</b>				
CK-3	531621	KD2-CK-3	4091	KS2-CK-3
CK-4	531622	KD2-CK-4	4090	KS2-CK-4



# Coupling sockets/quick coupling plugs KD/KS, shut off at one end

## Datasheet

### Plug-in coupling KD3/KS3

**Note**

All coupling sockets of the same size are compatible with all plugs of this size.

-  - Flow rate  
158 ... 666 l/min
-  - Nominal size  
2.9 ... 5 mm



#### General technical data – Coupling socket KD3

Pneumatic connection 1	Male thread		Female thread		Quick connector	
	G1/8	G1/4	G1/8	G1/4	CK-4	CK-6
Nominal size [mm]	4.95	5	5	5	2.9	4.9
Nominal tightening torque [Nm]	5 ±15%	9.5 ±15%	5 ±15%	9.5 ±15%	–	–
Product weight [g]	28	35	32	47	31	32

#### General technical data – Quick coupling plug KS3

Pneumatic connection 1	Male thread		Female thread		Quick connector	
	G1/8	G1/4	G1/8	G1/4	CK-4	CK-6
Nominal size [mm]	4.95	4.95	4.95	4.95	2.9	4.9
Nominal tightening torque [Nm]	5 ±15%	9.5 ±15%	5 ±15%	9.5 ±15%	–	–
Product weight [g]	13	23	16	27	16	21

#### Standard nominal flow rate $q_{nN}^{1)}$ [l/min]

Coupling socket/quick coupling plug combination	Coupling socket KD3						
	Male thread		Female thread		Quick connector		
	G1/8	G1/4	G1/8	G1/4	CK-4	CK-6	
<b>Quick coupling plug KS3</b>							
Male thread	G1/8	563	581	585	648	225	464
	G1/4	558	581	594	653	225	455
Female thread	G1/8	536	554	558	617	225	446
	G1/4	572	594	603	666	225	468
Quick connector	CK-4	185	185	185	185	158	180
	CK-6	428	437	441	464	216	378

1) Measured at  $p_1 = 6$  bar and  $\Delta p = 1$  bar

#### Operating and environmental conditions

Operating pressure for entire temperature range [bar]	–0.95 ... +12
Operating medium	Compressed air to ISO 8573-1:2010 [7:--]
Note on the operating/pilot medium	Lubricated operation possible
Ambient temperature [°C]	–10 ... +60
Corrosion resistance class CRC <sup>1)</sup>	1 - Low corrosion stress

1) More information [www.festo.com/x/topic/crc](http://www.festo.com/x/topic/crc)

#### Materials

	Coupling socket KD3	Quick coupling plug KS3
Housing	Nickel-plated brass	Nickel-plated brass
Releasing sleeve	Nickel-plated brass	–
Note on materials	RoHS-compliant	
LABS (PWIS) conformity	VDMA24364-B1/B2-L	

## Datasheet

## Dimensions – Coupling socket

Download CAD data → [www.festo.com](http://www.festo.com)

## Male thread

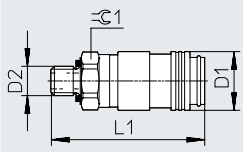

## Female thread

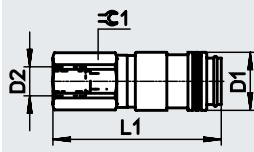

## Quick connector

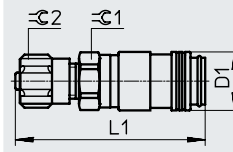

Connection	D1 ∅	D2	L1	⌀ C1	⌀ C2
<b>Male thread</b>					
G1/8	16	G1/8	36	14	-
G1/4		G1/4	37.6	17	
<b>Female thread</b>					
G1/8	16	G1/8	38.2	14	-
G1/4		G1/4	45.2	17	
<b>Quick connector with union nut</b>					
CK-4	16	-	43.1	14	12
CK-6			43.2		14

## Dimensions – Quick coupling plug

Download CAD data → [www.festo.com](http://www.festo.com)

## Male thread

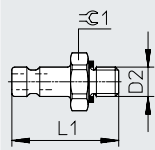

## Female thread

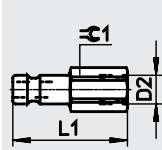

## Quick connector

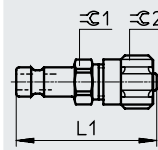

## Insertion depth

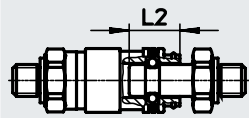

Connection	D1 ∅	D2	L1	L2	⌀ C1	⌀ C2
<b>Male thread</b>						
G1/8	16	G1/8	25	13.6	13	-
G1/4		G1/4	27.6		17	
<b>Female thread</b>						
G1/8	16	G1/8	28	13.6	13	-
G1/4		G1/4	32.6		17	
<b>Quick connector with union nut</b>						
CK-4	16	-	34.5	13.6	12	12
CK-6			34.6		14	14



## Ordering data

Connection	Coupling socket		Quick coupling plug	
	Part no.	Type	Part no.	Type
<b>Male thread</b>				
G1/8	2142	KD3-1/8-A	3492	KS3-1/8-A
G1/4	531626	KD3-1/4-A	531666	KS3-1/4-A
<b>Female thread</b>				
G1/8	531627	KD3-1/8-I	531668	KS3-1/8-I
G1/4	531628	KD3-1/4-I	531669	KS3-1/4-I
<b>Quick connector with union nut</b>				
CK-4	531629	KD3-CK-4	3326	KS3-CK-4
CK-6	531630	KD3-CK-6	3478	KS3-CK-6

## Datasheet

**Plug-in coupling KD4/KS4**

- Releasing sleeve made from polymer
- Coupling sockets KD4 can be combined with all quick coupling plugs NPHS-S6 → 18

-  - Flow rate  
252 ... 1350 l/min
-  - Nominal size  
2.9 ... 10 mm



-  - **Note**

All coupling sockets of the same size are compatible with all plugs of this size.  
The hardened quick coupling plugs NPHS-S6 must be used with couplings that are frequently subject to pressure surges or that have to be frequently mated.

**General technical data – Coupling socket KD4**

Pneumatic connection 1	Male thread			Female thread			Quick connector		Barbed fitting
	G1/4	G3/8	G1/2	G1/4	G3/8	G1/2	CK-6	CK-9	N-9
Nominal size [mm]	8	10		7.2			4.9	7.4	7.4
Nominal tightening torque [Nm]	9.5 ±15%	21.5 ±15%	32.5 ±20%	9.5 ±15%	21.5 ±15%	32.5 ±20%	-		
Product weight [g]	57	62	78	88	82	86	63	71	57

**General technical data – Quick coupling plug KS4**

Pneumatic connection 1	Male thread			Female thread			Quick connector			Barbed fitting	
	G1/4	G3/8	G1/2	G1/4	G3/8	G1/2	CK-4	CK-6	CK-9	N-6	N-9
Nominal size [mm]	7.85			7.85			2.9	4.9	7.4	4.5	7
Nominal tightening torque [Nm]	9.5 ±15%	21.5 ±15%	32.5 ±20%	9.5 ±15%	21.5 ±15%	32.5 ±20%	-				
Product weight [g]	21	29	55	31	32	57	26	26	26	15	18

**Standard nominal flow rate  $q_{nN^1}$  [l/min]**

Coupling socket/quick coupling plug combination	Coupling socket KD4									
	Male thread			Female thread			Quick connector		Barbed fitting	
	G1/4	G3/8	G1/2	G1/4	G3/8	G1/2	CK-6	CK-9	N-9	
<b>Quick coupling plug KS4</b>										
Male thread	G1/4	1260	1242	1296	1283	1305	1323	756	1098	1143
	G3/8	1283	1274	1319	1283	1323	1323	756	1116	1152
	G1/2	1283	1260	1301	1283	1323	1323	756	1098	1143
Female thread	G1/4	1125	1125	1148	1130	1161	1161	720	1008	1035
	G3/8	1287	1274	1337	1292	1350	1332	756	1116	1152
	G1/2	1287	1260	1305	1292	1314	1305	756	1116	1152
Quick connector	CK-4	261	261	257	257	261	257	252	261	
	CK-6	486	482	482	482	486	495	432	477	
	CK-9	1152	1143	1179	1161	1197	1197	725	1017	1044
Barbed fitting	N-6	486	482	482	482	486	495	441	477	
	N-9	1107	1089	1107	1098	1134	1125	711	981	1008

1) Measured at  $p_1 = 6$  bar and  $\Delta p = 1$  bar

## Datasheet

Operating and environmental conditions	
Operating pressure for entire temperature range [bar]	-0.95 ... +12
Operating medium	Compressed air to ISO 8573-1:2010 [7:-:-]
Note on the operating/pilot medium	Lubricated operation possible
Ambient temperature [°C]	-10 ... +60
Corrosion resistance class CRC <sup>1)</sup>	1 - Low corrosion stress

1) More information [www.festo.com/x/topic/crc](http://www.festo.com/x/topic/crc)

Materials	Coupling socket KD4	Quick coupling plug KS4
Housing	Nickel-plated brass	Nickel-plated brass
Releasing sleeve	Polypropylene	-
Note on materials	RoHS-compliant	
LABS (PWIS) conformity	VDMA24364-B1/B2-L	

## Dimensions – Coupling socket

Download CAD data → [www.festo.com](http://www.festo.com)

## Male thread

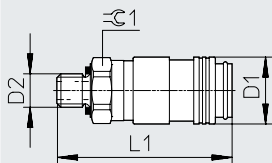

## Female thread

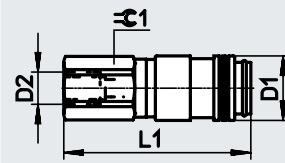

## Quick connector

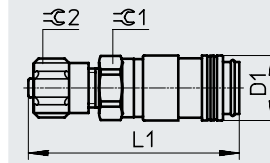

## Barbed fitting

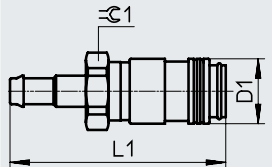

Connection	D1 ∅	D2	L1	⌀ 1	⌀ 2
<b>Male thread</b>					
G1/4	26.4	G1/4	40.5	22	-
G3/8		G3/8	41.5		
G1/2		G1/2	43		
<b>Female thread</b>					
G1/4	26.4	G1/4	46	22	-
G3/8		G3/8	47.5		
G1/2		G1/2	50.5		
<b>Quick connector with union nut</b>					
CK-6	26.4	-	46.4	22	14
CK-9			49.8		19
<b>Barbed fitting</b>					
N-9	26.4	12	56.2	21	-

## Datasheet

### Dimensions – Quick coupling plug

Download CAD data → [www.festo.com](http://www.festo.com)

#### Male thread

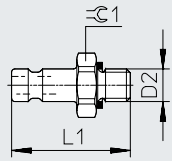

#### Female thread

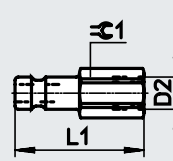

#### Quick connector

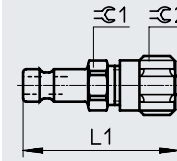

#### Barbed fitting

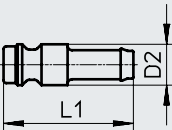

#### Insertion depth

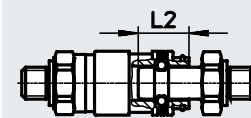

Connection	D1 ∅	D2	L1	L2	∅ C1	∅ C2
<b>Male thread</b>						
G1/4	26.4	G1/4	32.5	14.95	17	-
G3/8		G3/8	34		19	
G1/2		G1/2	37.5		24	
<b>Female thread</b>						
G1/4	26.4	G1/4	38.5	14.95	17	-
G3/8		G3/8	39.5		19	
G1/2		G1/2	44		24	
<b>Quick connector with union nut</b>						
CK-4	-	-	40.2	14.95	17	12
CK-6	26.4		40.3			14
CK-9			43.7		19	19
<b>Barbed fitting</b>						
N-6	26.4	12	47	14.95	-	-
N-9						

## Datasheet

## ★ Core Range

Ordering data				
Connection	Coupling socket		Quick coupling plug	
	Part no.	Type	Part no.	Type
<b>Male thread</b>				
G1/4	★ 2143	KD4-1/4-A	2154	KS4-1/4-A
G3/8	★ 2144	KD4-3/8-A	2155	KS4-3/8-A
G1/2	★ 2145	KD4-1/2-A	531676	KS4-1/2-A
<b>Female thread</b>				
G1/4	531636	KD4-1/4-I	531678	KS4-1/4-I
G3/8	531637	KD4-3/8-I	531679	KS4-3/8-I
G1/2	531638	KD4-1/2-I	531680	KS4-1/2-I
<b>Quick connector with union nut</b>				
CK-4	–		2150	KS4-CK-4
CK-6	531639	KD4-CK-6	2151	KS4-CK-6
CK-9	531640	KD4-CK-9	531683	KS4-CK-9
<b>Barbed fitting</b>				
N-6	–		2152	KS4-N-6
N-9	531641	KD4-N-9	2153	KS4-N-9

## Coupling sockets/quick coupling plugs KD/KS, shut off at both ends

### Datasheet

#### Plug-in coupling KD...-R/KS...-R

- Both ends are sealed after unlocking

 Flow rate  
563 l/min

 Nominal size  
4.2 ... 5 mm

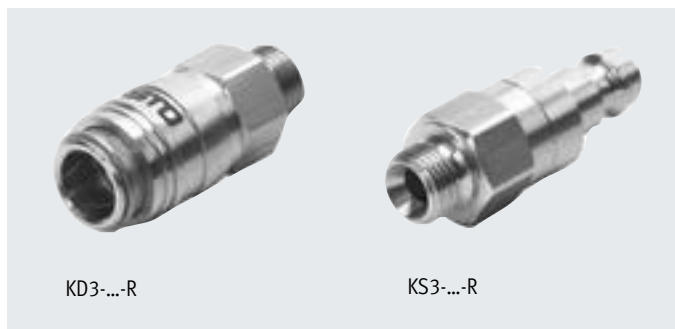

#### Note

Only coupling sockets and quick coupling plugs having the same function and size can be combined.

 Flow rate  
765 l/min

 Nominal size  
8 mm



General technical data		Coupling socket KD3	Quick coupling plug KS3	Coupling socket KD4	Quick coupling plug KS4
Pneumatic connection 1		Male thread	Male thread	Male thread	Male thread
		G1/8	G1/8	G1/4	G1/4
Nominal size	[mm]	5	4.2	8	8
Nominal tightening torque	[Nm]	5 ±15%	5 ±15%	9.5 ±15%	9.5 ±15%
Product weight	[g]	28	32	58	46

Standard nominal flow rate $q_{nN^{1)}$ [l/min]		Coupling socket KD3	Coupling socket KD4
Coupling socket/quick coupling plug combination		Male thread	Male thread
		G1/8	G1/4
<b>Quick coupling plug KS3</b>			
Male thread	G1/8	563	–
<b>Quick coupling plug KS4</b>			
Male thread	G1/4	–	765

1) Measured at  $p_1 = 6$  bar and  $\Delta p = 1$  bar

Operating and environmental conditions	
Operating pressure for entire temperature range	[bar] –0.95 ... +12
Operating medium	Compressed air to ISO 8573-1:2010 [7:-:-]
Note on the operating/pilot medium	Lubricated operation possible
Ambient temperature	[°C] –10 ... +60
Corrosion resistance class CRC <sup>1)</sup>	1 - Low corrosion stress

1) More information [www.festo.com/x/topic/crc](http://www.festo.com/x/topic/crc)



## Datasheet

Materials	Coupling socket	Quick coupling plug	Coupling socket	Quick coupling plug
		KD3	KS3	KD4
Housing	Brass		Brass	
Releasing sleeve	Nickel-plated brass	–	Polypropylene	–
Note on materials	RoHS-compliant			
LABS (PWIS) conformity	VDMA24364-B1/B2-L			

## Dimensions

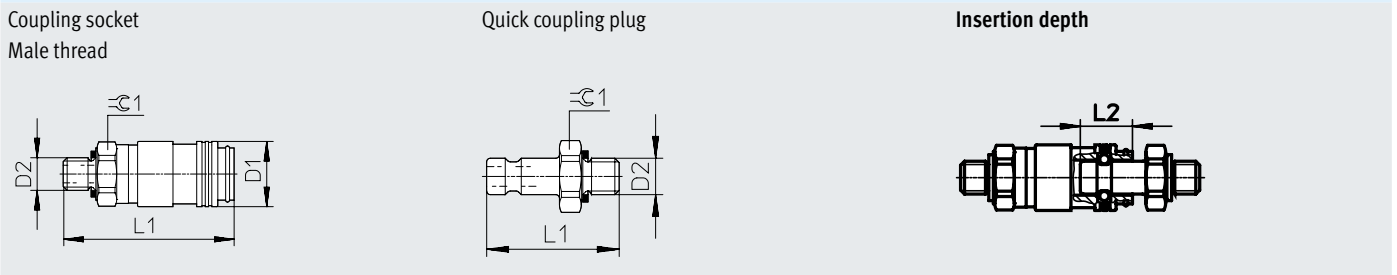
Download CAD data → [www.festo.com](http://www.festo.com)

Type	D1 ∅	D2	L1		L2	⌀ 1
			Coupling socket	Quick coupling plug		
<b>Male thread</b>						
G1/8	16	G1/8	36	39.8	13.6	14
G1/4	26.4	G1/4	40.5	42.5	14.95	22

## Ordering data

Connection	Coupling socket		Quick coupling plug	
	Part no.	Type	Part no.	Type
G1/8	531659	KD3-1/8-A-R	531667	KS3-1/8-A-R
G1/4	531694	KD4-1/4-A-R	531677	KS4-1/4-A-R

## Datasheet

### Safety coupling

#### NPFS-D6-M/NPFS-S6

- Metal releasing sleeve
- Combination of coupling and hand slide valve
- Exhausting the air at the connector end without releasing the coupling
- Can be used as an on/off valve

-  - Flow rate  
1750 ... 2100 l/min

-  - Nominal size  
5.5 ... 10 mm



### Safety coupling

#### NPFS-D6-P/NPFS-S6

- Polymer releasing sleeve
- Exhausting the air at the connector end without releasing the coupling

-  - Flow rate  
875 ... 2083 l/min

-  - Nominal size  
5 ... 11 mm



### - - Note

All coupling sockets NPFS-D6 are compatible with all plugs NPFS-S6. In addition, the coupling sockets NPFS-D6-M and all quick coupling plugs NPFS-S6 can be combined with brass coupling sockets/quick coupling plugs KD4/KS4.

In contrast, the coupling sockets NPFS-D6-P may only be used with the hardened quick coupling plugs NPFS-S6. No safety function when combining coupling socket KD4 with quick coupling plug NPFS-S6. In this combination, the plug is released in just one step.

### Operating mode

Coupling socket NPFS-D6-M and quick coupling plug NPFS-S6

#### Coupling

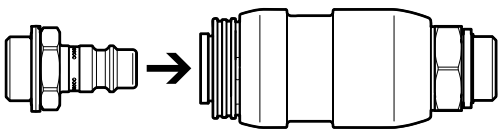

Push the plug into the socket to lock the coupling. The plug automatically engages with an audible click when in a specific position.

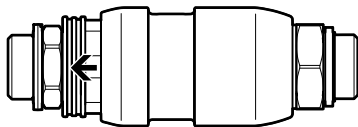

When the plug is engaged, the releasing sleeve shifts slightly in the direction of the plug. This releases the locking mechanism between the releasing sleeve and the sliding sleeve. The sliding sleeve can now be actuated.

#### Pressurisation



To pressurise, push the sliding sleeve in the direction of the plug.

Coupling socket NPFS-D6-P and quick coupling plug NPFS-S6

#### Coupling

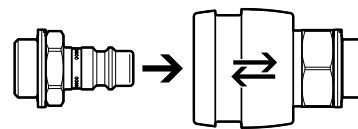

Push the plug into the socket to lock the coupling. The plug automatically engages with an audible click when in a specific position. During this process, the releasing sleeve moves briefly back and then forward again.

## Datasheet

### Operating mode

Coupling socket NPHS-D6-M and quick coupling plug NPHS-S6

Exhausting

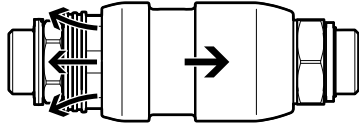

To exhaust, push the sliding sleeve in the direction of the thread on the coupling socket. The air from the plug and the components connected to it can escape. The air at the coupling end is shut off. The releasing sleeve can now be accessed.

Point to note:

To repressurise the plug, the sliding sleeve must be pushed in the direction of the plug once more. The plug doesn't need to be completely released from the socket before doing this. This safety coupling can thus be used as an on/off valve, for example.

Decoupling

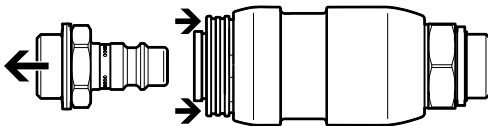

Unlock the plug fully by pushing the releasing sleeve. The plug should only be removed after all the air has been exhausted. With the plug removed, the two sleeves cannot slide or be pushed.

 **Note**

Pressurise or exhaust the coupling to a maximum of 10 bar only. Hearing protection is recommended, especially at higher operating pressures.

 **Note**

Safety exhaust couplings with coupling sockets NPHS-D6 fulfil the requirements for pneumatic systems to EN ISO 4414.

Coupling socket NPHS-D6-P and quick coupling plug NPHS-S6

Exhausting

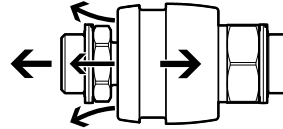

To exhaust, first push the releasing sleeve in the direction of the thread on the coupling socket. This releases the pin locking mechanism of the coupling. The plug moves approx. 5 mm out of the coupling and is held in this position by the ball locking mechanism of the coupling. The air from the plug and the components connected to it can escape. The air at the coupling end is shut off.

Point to note:

To repressurise the plug, it must be pushed into the socket once more. The plug doesn't need to be completely released from the socket before doing this.

Decoupling

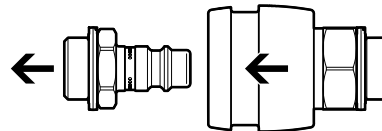

Next, release the plug from the ball locking mechanism by pulling the releasing sleeve. This releases the plug completely so that it can be removed from the socket. The plug should only be removed after all the air has been exhausted.

### General technical data – Coupling socket NPHS-D6

Pneumatic connection 1	Male thread								Female thread			For plug-in nipple
	NPHS-D6-M			NPHS-D6-P					NPHS-D6-P			NPHS-D6-P
	G1/4	G3/8	G1/2	G1/8	G1/4	G3/8	G1/2	G1/4	G3/8	G1/2	I.D. 9 mm	
Nominal size [mm]	8.2	10	10	5	7.8	10.2	11	–	–	–	7	
Nominal tightening torque [Nm]	7 ±20%	15 ±20%	25 ±20%	3.5 ±10%	11 ±10%	12.5 ±20%	14 ±20%	–	–	–	–	
Product weight [g]	173	179	200	94	95	98	113	124	114	122	95	

### General technical data – Quick coupling plug NPHS-S6

Pneumatic connection 1	Male thread				Female thread			For plug-in nipple
	G1/8	G1/4	G3/8	G1/2	G1/4	G3/8	G1/2	I.D. 9 mm
Nominal size [mm]	5.5	7.85	7.85	7.85	7.85	7.85	7.85	7
Nominal tightening torque [Nm]	3.5 ±10%	11 ±10%	12.5 ±20%	14 ±20%	–	–	–	–
Product weight [g]	19	20	27	50	28	29	49	17

# Coupling sockets/quick coupling plugs NPHS, shut off at one end

## Datasheet

Standard nominal flow rate $q_{nN}^{1)}$ [l/min]				
Coupling socket/quick coupling plug combination	Coupling socket NPHS-D6-M			
	Male thread			
	G1/4	G3/8	G1/2	
<b>Quick coupling plug NPHS-S6</b>				
Male thread	G1/4	1833	2100	2100
	G3/8	1800	2050	2050
	G1/2	1750	2000	2000

1) Measured at  $p_1 = 6$  bar and  $\Delta p = 1$  bar

Standard nominal flow rate $q_{nN}^{1)}$ [l/min]									
Coupling socket/quick coupling plug combination	Coupling socket NPHS-D6-P								
	Male thread					Female thread			For plug-in nipple
	G1/8	G1/4	G3/8	G1/2	G1/4	G3/8	G1/2	I.D. 9 mm	
<b>Quick coupling plug NPHS-S6</b>									
Male thread	G1/8	875	1183	1216	1233	1183	1203	1238	1093
	G1/4	1038	1916	2033	2016	2033	2000	1983	1585
	G3/8	1038	1883	2033	1983	2033	1950	1950	1585
	G1/2	1002	1883	1966	1950	1966	1916	1916	1533
Female thread	G1/4	1002	1883	1950	1916	1800	1800	1008	1503
	G3/8	1050	1966	2083	2016	2050	2083	2050	1613
	G1/2	1038	1883	2000	1983	1933	2050	1950	1613
For plug-in nipple	I.D. 9 mm	966	1585	1640	1585	1585	1700	1640	1448

1) Measured at  $p_1 = 6$  bar and  $\Delta p = 1$  bar

Operating and environmental conditions			
		Coupling socket	Quick coupling plug
		NPHS-D6-M	NPHS-D6-P
Operating pressure for entire temperature range	[bar]	-0.95 ... +20 <sup>1)</sup>	-0.95 ... +10 (-0.95 ... +20) <sup>2)</sup>
Operating medium		Compressed air to ISO 8573-1:2010 [7:-:-]	
Note on the operating/pilot medium		Lubricated operation possible	
Ambient temperature	[°C]	-20 ... +80	-10 ... +60
Corrosion resistance class CRC <sup>3)</sup>		1 - Low corrosion stress	
Noise level <sup>4)</sup>	[dB(A)]	110 (at 6 bar)	93 (at 6 bar)
		113 (at 10 bar)	98.7 (at 10 bar)
		117 (at 16 bar)	-

1) Pressurise or exhaust the coupling to a maximum of 10 bar only. Hearing protection is recommended, especially at higher operating pressures. 20 bar is the maximum static operating pressure (without pulsation).

2) Using a suitable sealing ring (e.g. sealing ring OL) it is possible to achieve a static operating pressure (without pulsation) of up to 20 bar in a temperature range of -20°C to +100°C.

3) More information [www.festo.com/x/topic/crc](http://www.festo.com/x/topic/crc)

4) Measured at a distance of 1 m, 10 l volume via the coupling open and exhausted under pressure.

Materials			
		Coupling socket	Quick coupling plug
		NPHS-D6-M	NPHS-D6-P
Housing		Nickel-plated brass	Nickel-plated brass
Sliding sleeve		Colourless anodised aluminium	-
Releasing sleeve		Nickel-plated brass	PP
Note on materials		RoHS-compliant	
LABS (PWIS) conformity		VDMA24364-B2-L	

## Datasheet

## Dimensions – Coupling socket

Download CAD data → [www.festo.com](http://www.festo.com)

Male thread

NPHS-D6-M

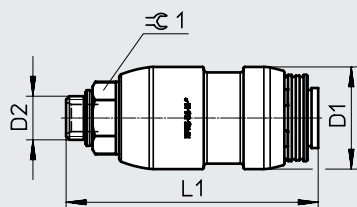

Male thread

NPHS-D6-P

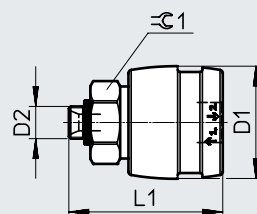

Female thread

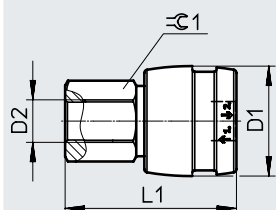

For plug-in nipple

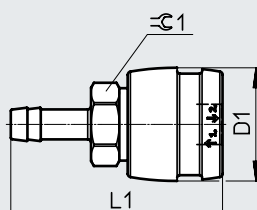

Connection	D1 ø	D2	L1	H9/k9
<b>Male thread, coupling socket NPHS-D6-M</b>				
G1/4	30.8	G1/4	76	19
G3/8		G3/8	77	22
G1/2		G1/2	80.5	24
<b>Male thread, coupling socket NPHS-D6-P</b>				
G1/8	34	G1/8	46.5	22
G1/4		G1/4	48	22
G3/8		G3/8	49	22
G1/2		G1/2	50.5	24
<b>Female thread</b>				
G1/4	34	G1/4	53	22
G3/8		G3/8	53	22
G1/2		G1/2	56	24
<b>For plug-in nipple</b>				
I.D. 9 mm	34	–	63.6	22

## Datasheet

### Dimensions – Quick coupling plug

Download CAD data → [www.festo.com](http://www.festo.com)

#### Male thread

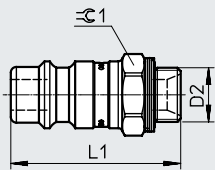

#### Female thread

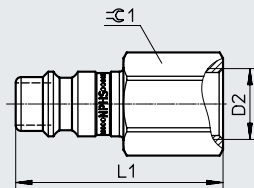

#### For plug-in nipple

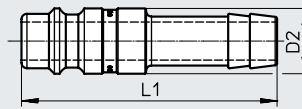

### Insertion depth

#### NPHS-D6-M

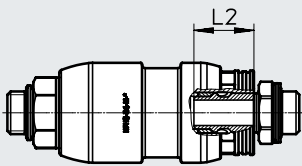

#### NPHS-D6-P

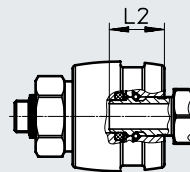

Type	D2	L1	L2		≈ 1
			NPHS-D6-M	NPHS-D6-P	
<b>Male thread</b>					
G1/8	G1/8	30.5	18.6 ± 0.4	17.1 ± 0.3	13
G1/4	G1/4	32.5			17
G3/8	G3/8	34			19
G1/2	G1/2	37.5			24
<b>Female thread</b>					
G1/4	G1/4	38.5	18.6 ± 0.4	17.1 ± 0.3	17
G3/8	G3/8	39.5			19
G1/2	G1/2	44			24
<b>For plug-in nipple</b>					
I.D. 9 mm	12	47	18.6 ± 0.4	17.1 ± 0.3	–

## Datasheet

## ★ Core Range

Ordering data – Coupling socket				
Connection	Polymer releasing sleeve		Metal releasing sleeve	
	Part no.	Type	Part no.	Type
<b>Male thread</b>				
G1/8	8059266	NPHS-D6-P-G18	–	
G1/4	★ 8059267	NPHS-D6-P-G14	8059275	NPHS-D6-M-G14
G3/8	★ 8059268	NPHS-D6-P-G38	8059276	NPHS-D6-M-G38
G1/2	★ 8059269	NPHS-D6-P-G12	8059277	NPHS-D6-M-G12
<b>Female thread</b>				
G1/4	8059271	NPHS-D6-P-G14F	–	
G3/8	8059272	NPHS-D6-P-G38F	–	
G1/2	8059273	NPHS-D6-P-G12F	–	
<b>For plug-in nipple</b>				
I.D. 9 mm	8059274	NPHS-D6-P-BC9	–	

Ordering data - Quick coupling plug		
Connection	Part no.	Type
<b>Male thread</b>		
G1/8	★ 8059257	NPHS-S6-M-G18
G1/4	★ 8059258	NPHS-S6-M-G14
G3/8	★ 8059259	NPHS-S6-M-G38
G1/2	★ 8059260	NPHS-S6-M-G12
<b>Female thread</b>		
G1/4	★ 8059262	NPHS-S6-M-G14F
G3/8	★ 8059263	NPHS-S6-M-G38F
G1/2	★ 8059264	NPHS-S6-M-G12F
<b>For plug-in nipple</b>		
I.D. 9 mm	8059265	NPHS-S6-M-BC9

# Union nut MCK

## Accessories

### Union nut MCK<sup>1)</sup>

For quick connector



#### Operating and environmental conditions

Operating pressure for entire temperature range	[MPa]	-0.095 ... +1.2
	[bar]	-0.95 ... +12
	[psi]	-13.775 ... +174
Ambient temperature	[°C]	-10 ... +60
Corrosion resistance class CRC <sup>1)</sup>		1 - Low corrosion stress

1) More information [www.festo.com/x/topic/crc](http://www.festo.com/x/topic/crc)

#### Materials

Union nut material	Nickel-plated wrought aluminium alloy
Note on materials	RoHS-compliant
LABS (PWS) conformity	VDMA24364-B2-L

#### Dimensions

Download CAD data → [www.festo.com](http://www.festo.com)

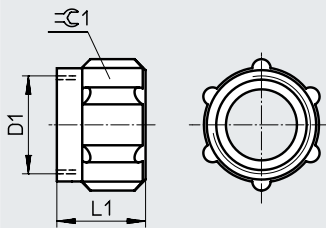

#### Ordering data

Size	Pneumatic connection		L1	≅G1	Part no.	Type
Female thread	For tubing O.D.	For barbed connector I.D. <sup>1)</sup>				
D1	[mm]	[mm]				

#### Aluminium version

M6x0.75	4	3	8.5	8	533672	MCK-PK-3-KD
M10x1	6	4	11	12	533673	MCK-PK-4-KD
M12x1	8	6	11	14	533674	MCK-PK-6-KD
M16x1	-	9	14.4	19	533675	MCK-PK-9-KD

1) With union nut