



Solenoid valves, to NAMUR



Solenoid valves, to NAMUR

Product range overview

Function	Version	Type	Nominal size [mm]	Standard nominal flow rate [l/min]	Pneumatic connection	Operating pressure [bar]	Ambient temperature [°C]
5/2-way valves ¹⁾		NVF3-...-EX	7	900	G1/4	2 ... 10	-5 ... +40
							ATEX: -5 °C ≤ Ta ≤ +40 °C
		NVF3-...-IA-EX	7	900	G1/4	2 ... 10	ATEX: -5 °C ≤ Ta ≤ +40 °C

1) Can be changed to 3/2-way function by exchanging the seal plate

Solenoid valves, to NAMUR

Product range overview

Type	Solenoid coil	Operating voltage range		Ignition protection type			→ Page/Internet
		[V DC]	[V AC]	nA = Non-sparking	m = Encapsulation	ia = Intrinsically safe	
NVF3-...-EX	MSFG-...-OD ¹⁾ , MSFW-...-OD ¹⁾	12, 24, 42, 48	24, 42, 48, 110, 230, 240	-	-	-	6
	MSFG-...-EX ¹⁾ , MSFW-...-EX ¹⁾	24	24, 110, 230	■	-	-	
	MSFG-...-M-EX ¹⁾ , MSFW-...-M-EX ¹⁾	24	24, 110, 230	-	■	-	
NVF3-...-IA-EX	Included in the scope of delivery	24	-	-	-	■	

1) Solenoid coil must be ordered separately

Solenoid valves NVF3, to NAMUR

Peripherals overview

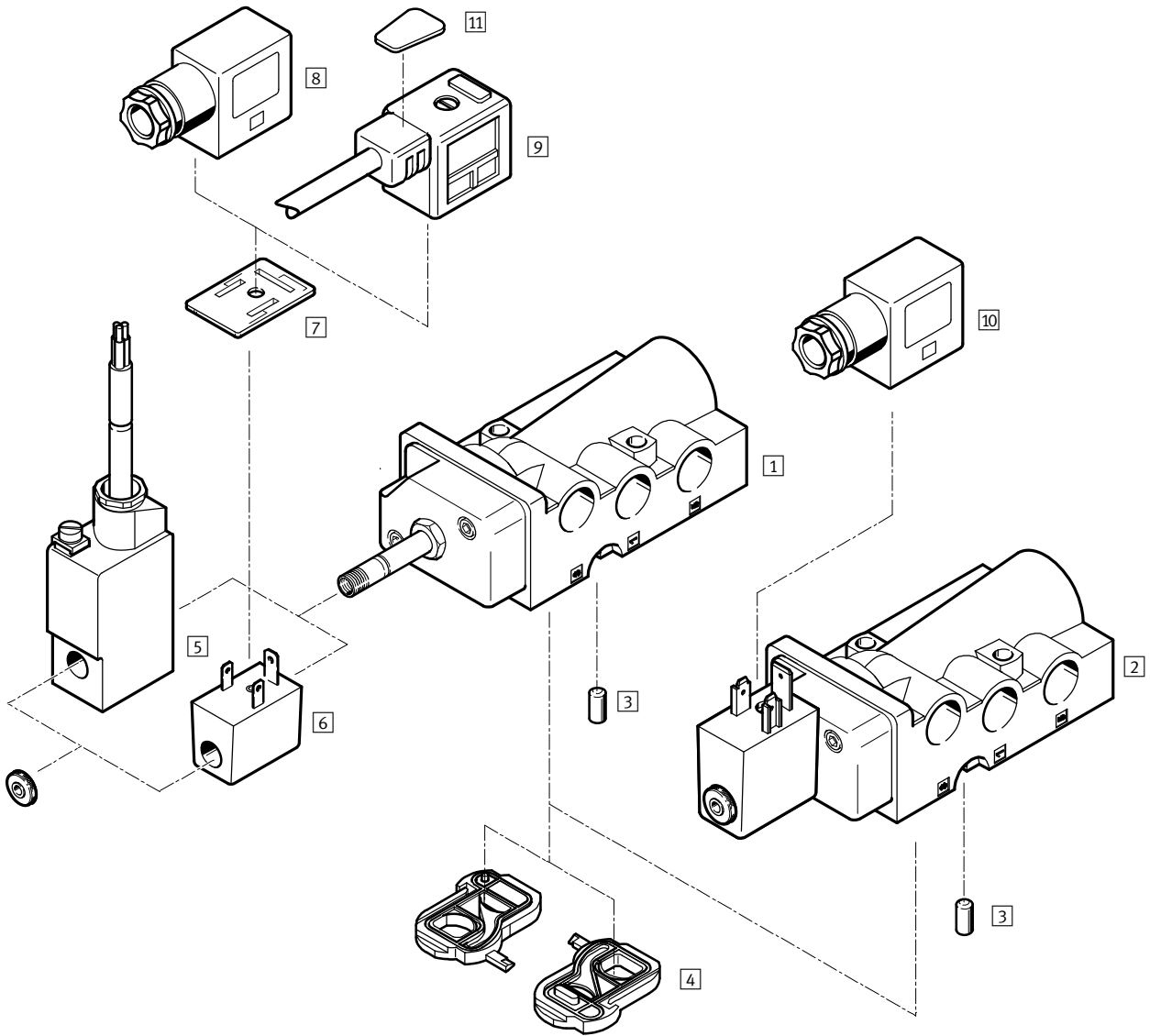

Solenoid valves NVF3, to NAMUR

Peripherals overview

Solenoid valves and accessories		
	Brief description	→ Page/Internet
Solenoid valves		
1	NVF3-MOH-5/2K-1/4-EX	6
2	NVF3-MOH-5/2K-1/4-IA-EX Solenoid valve mounted with intrinsically safe solenoid coil, ignition protection type ia = intrinsically safe	
Accessories		
3	Coding pin	10
4	Seal plate	
5	Solenoid coil MSFG-...-M-EX and MSFW-...-M-EX	
6	Solenoid coil MSFG-...-EX and MSFW-...-EX	
7	Illuminating seal MF-LD	
8	Plug socket MSSD-F-M16 Insert can be repositioned by 180°. Ignition protection type nA = non-sparking for solenoid coil in item 6	
9	Plug socket with cable KMF	
10	Plug socket MSSD-V-M16 Insert can be repositioned by 180°. Ignition protection type ia = intrinsically safe for solenoid coil in item 2	
11	Inscription labels KMC/F/V-BZ	
	For identifying the plug sockets	

Solenoid valves NVF3, to NAMUR

Technical data

Function¹⁾

5/2-way valve

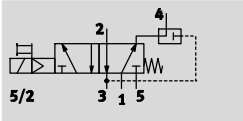

3/2-way valve

with exhaust air return

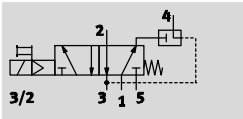

- - Voltage
12, 24, 42, 48 V DC
24, 42, 48, 110, 230,
240 V AC

- - Pressure
2 ... 10 bar

- - Temperature range
-5 ... +40 °C
ATEX
-5 °C ≤ Ta ≤ +40 °C



1) Can be changed by exchanging the seal plate

General technical data			Solenoid valve with F coil of choice	Solenoid valve with mounted solenoid coil
Valve function	5/2-way or 3/2-way, single solenoid			
Conforms to	VDI/VDE 3845 (NAMUR)			
Width	[mm]	53		
Design	Disk seat			
Sealing principle	Soft			
Actuation type	Electric			
Reset method	Mechanical spring			
Type of control	Piloted			
Direction of flow	Non-reversible			
Exhaust function	Flow control			
Manual override	Detenting, non-detenting			
Type of mounting	On manifold rail			
Mounting position	Any			
Non-overlapping	No			
Vent connection	Internal			
Nominal size	[mm]	7		
Standard nominal flow rate	1 → 2, 2 → 3	[l/min]	900	
Exhaust air return	2 → 4	[l/min]	150	
b value	0.33			
C value	[l/sbar]	4.2		
Pneumatic connection	1, 3, 5	G1/4		
	2, 4	Port pattern as per NAMUR		
	Pilot exhaust port 84	M5		
Product weight	[g]	280	350	

Solenoid valves NVF3, to NAMUR

Technical data

Operating and environmental conditions		
	Solenoid valve with F coil of choice	Solenoid valve with mounted solenoid coil
Operating medium	Compressed air in accordance with ISO 8573-1:2010 [7:4:4]	
Note on operating/pilot medium	Operation with lubricated medium possible (in which case lubricated operation will always be required)	
Operating pressure [bar]	2 ... 10	
Ambient temperature [°C]	-5 ... +40	
Temperature of medium [°C]	-5 ... +40	
ATEX category for gas	II 2G	
Explosion ignition protection type for gas	c T6	
ATEX category for dust	II 2D	
Explosion ignition protection type for dust [°C]	40	
Explosion-proof temperature rating	-5 °C ≤ Ta ≤ +40 °C	
Explosion protection certification outside the EU	-	EPL Db (RU)
	-	EPL Dc (RU)
	-	EPL Gb (RU)
	-	EPL Gc (RU)
CE marking	To EU Explosion Protection Directive (ATEX)	
Corrosion resistance class CRC	1 ¹⁾	

1) Corrosion resistance class 1 according to Festo standard 940 070. Components subject to low corrosion stress. Transport and storage protection. Parts that do not have primarily decorative surface requirements, e.g. in internal areas that are not visible or behind covers.

Electrical data		
	Solenoid valve with F coil of choice	Solenoid valve with mounted solenoid coil
Electrical connection	Plug, 3-pin or cable, 3-wire	Cable, 3-wire
Operating voltage range	[V DC]	12, 24, 42, 48
	[V AC]	24, 42, 48, 110, 230, 240 at 50 ... 60 Hz
Coil characteristics, 24 V DC [W]	-	0.8
Max. input power [W]	-	1.46
Max. input voltage [V]	-	48
Max. input current [A]	-	0.487
Effective inductance	-	Negligibly low
Effective capacitance	-	Negligibly low
Protection class to EN 60529	IP65 with plug socket	IP65 with plug socket
Switching time on [ms]	50	50
Switching time off [ms]	100	100

Solenoid valves NVF3, to NAMUR

Technical data



Materials

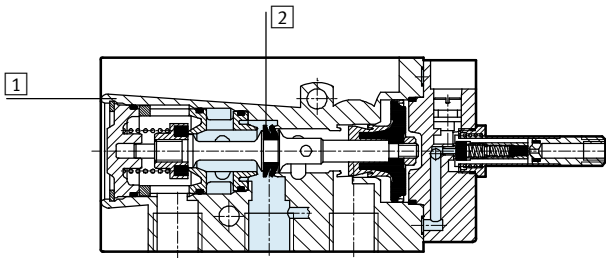

1	Housing	Anodised die-cast aluminium
2	Seals	NBR
		Contains PWIS (paint-wetting impairment substances)

Sample circuit

5/2-way valve

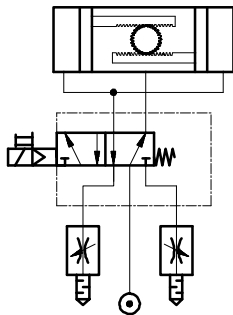

3/2-way valve with the option of exhaust air return

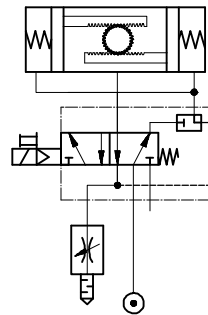

Solenoid valves NVF3, to NAMUR

Technical data

Dimensions

Download CAD data → www.festo.com

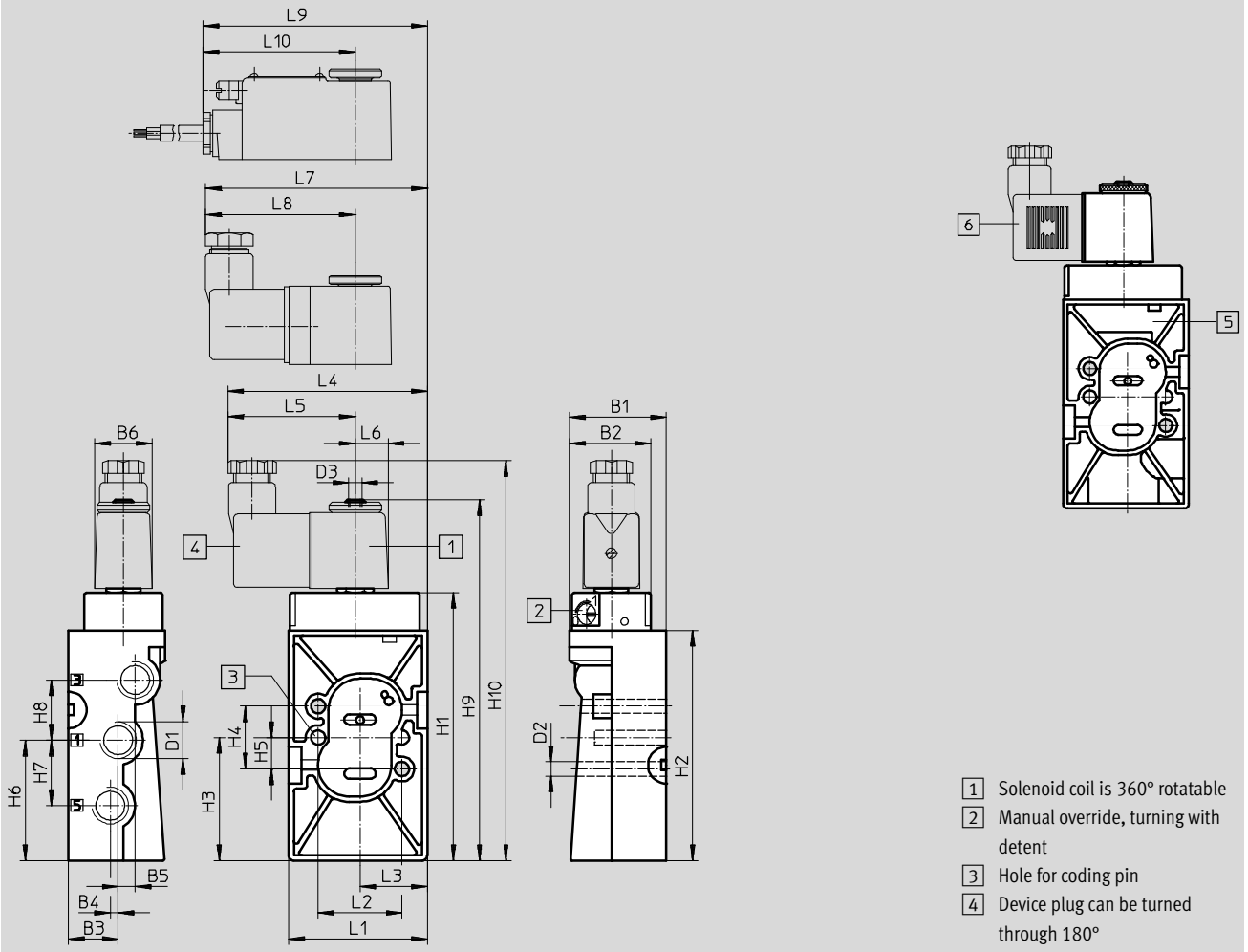

- 1 Solenoid coil is 360° rotatable
- 2 Manual override, turning with detent
- 3 Hole for coding pin
- 4 Device plug can be turned through 180°

Type	B1	B2	B3 ±0.1	B4 ±0.1	B5 ±0.1	B6	D1	D2 ∅	D3	H1	H2	H3 ±0.15	H4 ±0.15	H5 ±0.1	H6 ±0.1
NVF3-...	37	31	19	3	6.5	22	G1/4	5.5	M5	102.4	88	47	24	12	46

Type	H7 ±0.15	H8 ±0.15	H9	H10	L1 ±0.2	L2 ±0.15	L3 ±0.1	L4	L5	L6	L7	L8	L9	L10
NVF3-...	25	23	136.4	153	53	32	27.7	76.5	49	12.5	84.7	57.2	85.3	57.8

Ordering data – Valves

Solenoid valve without solenoid coil¹⁾

Solenoid valve mounted with intrinsically safe solenoid coil

Part No. Type

Part No. Type

535987 NVF3-MOH-5/2-K-1/4-EX





535988 NVF3-MOH-5/2-K-1/4-IA-EX

1) Solenoid coil must be ordered separately → 10,
Explosion-proof solenoid coil → 11

Solenoid valves NVF3, to NAMUR

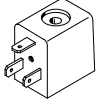
Accessories

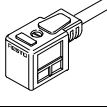
FESTO

Ordering data				
	Operating voltage	Cable length	Part No.	Type
F solenoid coil without plug socket Technical data → Internet: msfg, msfw				
	12 V DC	–	34410	MSFG-12DC-OD
	24 V DC	–	34411	MSFG-24/42-50/60-OD
	42 V DC	–	34413	MSFG-42DC-OD
	24 V AC/50 ... 60 Hz	–	34415	MSFW-24AC-OD
	42 V AC/50 ... 60 Hz	–	34411	MSFG-24/42-50/60-OD
	48 V AC/50 ... 60 Hz	–	34418	MSFW-48AC-OD
	110 V AC/50 ... 60 Hz	–	34420	MSFW-110AC-OD
	230 V AC/50 ... 60 Hz	–	34422	MSFW-230AC-OD
	240 V AC/50 ... 60 Hz	–	34424	MSFW-240AC-OD
Plug socket with screw terminal connection Technical data → Internet: mssd				
	–	–	34431	MSSD-F
	–	–	539710	MSSD-F-M16
Plug socket with insulation displacement connection Technical data → Internet: mssd				
	–	–	192746	MSSD-F-S-M16
Plug socket with cable Technical data → Internet: kmf-1				
	24 V DC	2.5 m	30935	KMF-1-24DC-2,5-LED
	0 ... 240 V DC/AC		30936	KMF-1-230AC-2,5
	24 V DC	5 m	30937	KMF-1-24DC-5-LED
	0 ... 240 V DC/AC		30938	KMF-1-230AC-5
	Illuminating seal Technical data → Internet: mf-ld			
	12 ... 24 V DC/AC	–	19143	MF-LD-12-24DC
	230 V DC/AC	–	19144	MF-LD-230AC
Inscription label Technical data → Internet: kmc/f/v				
–	–	–	33362	KMC/F/V-BZ-35X¹⁾

1) Scope of delivery 35 pieces

 **Note**







Valve/solenoid coil combinations made up of a basic valve NVF3-MOH-5/2-K-¼-EX and a solenoid coil MSF...-OD must not be used in hazardous areas.

Only combinations with the approved solenoid coil MSF...-EX may be used here. → 11

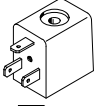
Solenoid valves NVF3, to NAMUR

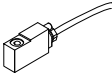
Accessories for ATEX environment

FESTO

Ordering data				
	Operating voltage	Cable length	Part No.	Type
F solenoid coil for ignition protection type nA = non-sparking Technical data → Internet: msfw, msfg				
 	24 V DC	–	536931	MSFG-24-EX
	24 V AC/50 ... 60 Hz	–	536932	MSFW-24-50/60-EX
	110 V AC/50 ... 60 Hz	–	536933	MSFW-110-50/60-EX
	230 V AC/50 ... 60 Hz	–	536934	MSFW-230-50/60-EX
F solenoid coil for ignition protection type m = encapsulation, moulded-in cable Technical data → Internet: msfw, msfg				
 	24 V DC	1 m	535619	MSFG-24DC-M-EX
	24 V DC	5 m	535621	MSFG-24DC-K5-M-EX
	24 V AC/50 ... 60 Hz	1 m	535623	MSFW-24AC-M-EX
	110 V AC/50 ... 60 Hz	1 m	535622	MSFW-110AC-M-EX
	110 V AC/50 ... 60 Hz	5 m	535624	MSFW-110AC-K5-M-EX
	230 V AC/50 ... 60 Hz	1 m	535620	MSFW-230AC-M-EX
	230 V AC/50 ... 60 Hz	5 m	535625	MSFW-230AC-K5-M-EX
	24 V DC	x m	538215	MSFG-24DC-KX-M-EX
	24 V AC/50 ... 60 Hz	x m	538218	MSFW-24AC-KX-M-EX
	110 V AC/50 ... 60 Hz	x m	538217	MSFW-110AC-KX-M-EX
230 V AC/50 ... 60 Hz	x m	538216	MSFW-230AC-KX-M-EX	
Plug socket with screw terminal connection for solenoid coil MSF...-EX, ignition protection type nA = non-sparking Technical data → Internet: mssd				
	–	–	539710	MSSD-F-M16
Plug socket with screw terminal connection for solenoid valve NVF3-MOH-5/2-K-¼-IA-EX, ignition protection type ia = intrinsically safe Technical data → Internet: mssd				
	–	–	539713	MSSD-V-M16