

Proportional pressure regulators MPPES

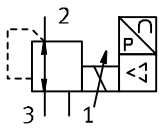

Proportional pressure regulators MPPES

Product range overview

Function	Type	Circuit symbol	Design	Pneumatic connection 1	Nominal size pressurise/ exhaust [mm]	Pressure regulation range ¹⁾ [bar]	Setpoint input		→ Page/ Internet
							Voltage type 0 ... 10 V	Current type 4 ... 20 mA	
Proportional pressure regulators	With proportional solenoid								
	MPPES		Directly actuated valve	G1/8	3/2	0 ... 2 0 ... 6 0 ... 10	<input type="checkbox"/>	<input type="checkbox"/>	5
			Pilot-actuated valve	G1/4	7/7		<input type="checkbox"/>	<input type="checkbox"/>	
				G1/2	11/12		<input type="checkbox"/>	<input type="checkbox"/>	

1) Pressure regulation range also by customer request

Proportional pressure regulators MPPES

Peripherals overview

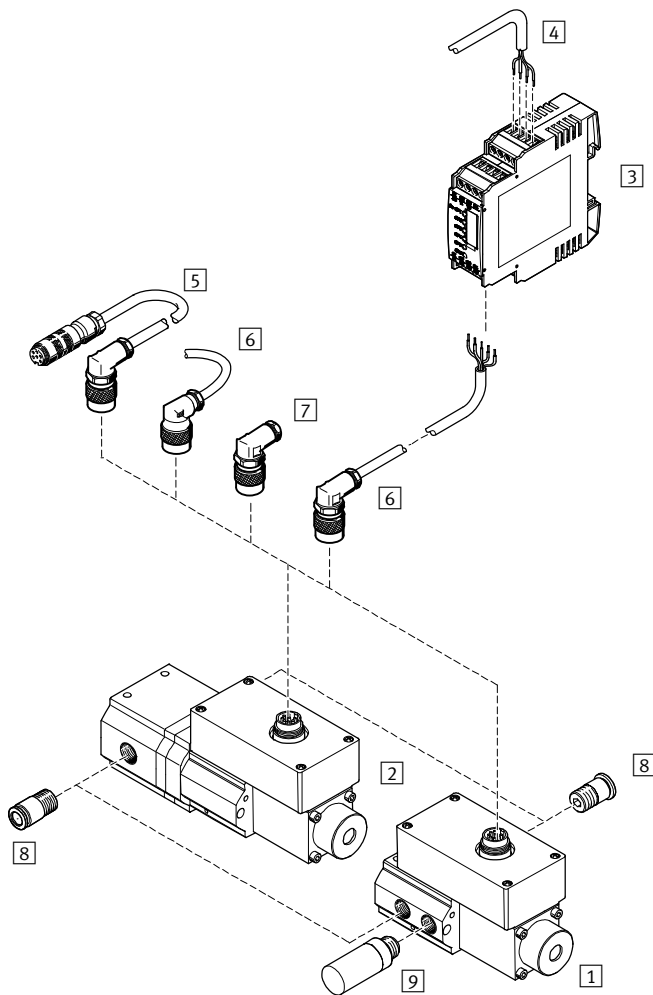

Accessories				
	Type	Brief description	→ Page/Internet	
1	Proportional pressure regulator	MPPES	Directly controlled	5
2	Proportional pressure regulator	MPPES	Indirectly controlled	5
3	Setpoint module MPZ	MPZ	For generating 6+1 analogue voltage signals	10
4	Digital input/output	-	For controlling the setpoint module	-
5	Connecting cable	KVIA-MPPE	-	10
6	Plug socket with cable	KMPE-B	-	
7	Angled socket	MPPE-3-B	-	
8	Push-in fitting	QS	For connecting compressed air tubing	qs
9	Silencer	U	For fitting in exhaust ports	u

Proportional pressure regulators MPPES

Type codes

FESTO

Basic version



		MPPES	-	3	-	1/8	-	1	-	010
Type										
MPPES	Proportional pressure regulator with proportional solenoid									
Valve function										
3	3-way pressure regulator									
Pneumatic connection										
1/8	Female thread G1/8									
1/4	Female thread G1/4									
1/2	Female thread G1/2									
Pressure regulation range										
2	0 ... 2 bar									
6	0 ... 6 bar									
10	0 ... 10 bar									
Analogue setpoint input										
010	0 ... 10 V									
420	4 ... 20 mA									

Special pressure regulation range by customer request

		MPPES	-	3	-	1/8	-	2	-	4	-	010
Type												
MPPES	Proportional pressure regulator with proportional solenoid											
Valve function												
3	3-way pressure regulator											
Pneumatic connection												
1/8	Female thread G1/8											
1/4	Female thread G1/4											
1/2	Female thread G1/2											
Required pressure at 0 V or 4 mA [bar]												
Required pressure at 10 V or 20 mA [bar]												
Analogue setpoint input												
010	0 ... 10 V											
420	4 ... 20 mA											

Proportional pressure regulators MPPES

Technical data

-  Flow rate
230 ... 8,500 l/min
-  Voltage
18 ... 30 V DC
-  Pressure regulation range
0 ... 2 bar
0 ... 6 bar
0 ... 10 bar

- Variants
- Setpoint input as analogue voltage signal 0 ... 10 V
 - Setpoint input as analogue current signal 4 ... 20 mA



General technical data					
Pneumatic connection		G1/8	G1/4	G1/2	
Design		Directly actuated piston regulator	Pilot-actuated piston regulator		
Sealing principle		Soft			
Actuation type		Electrical			
Type of mounting		Via through-hole			
Mounting position		Any			
Nominal size	Pressurisation	[mm]	3	7	11
	Exhaust	[mm]	2	7	12
Standard nominal flow rate		[l/min]	→ Graphs		
Product weight		[g]	915	1,310	2,670

Flow rate qn as a function of output pressure p2

Pneumatic connection G1/8

Pressure regulation range 0 ... 2 bar

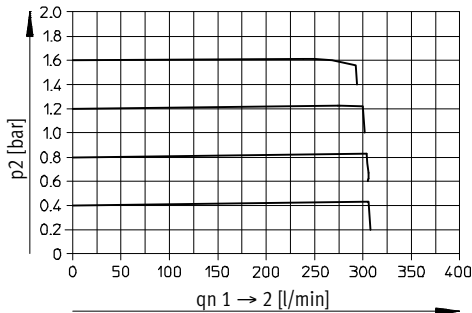

Pressure regulation range 0 ... 6 bar

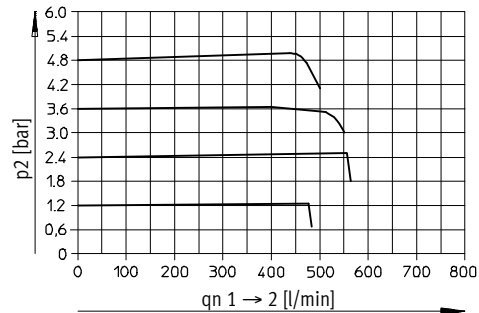

Pressure regulation range 0 ... 10 bar

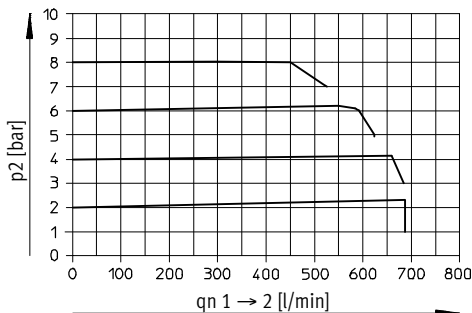

Proportional pressure regulators MPPES

Technical data

FESTO

Flow rate q_n as a function of output pressure p_2

Pneumatic connection G $\frac{1}{4}$

Pressure regulation range 0 ... 2 bar

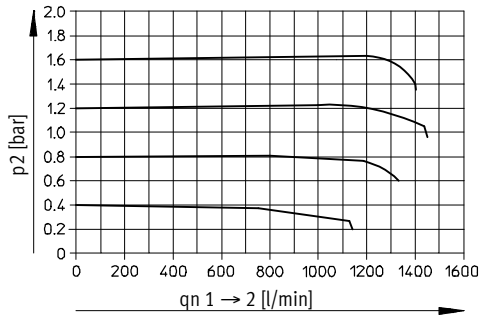

Pressure regulation range 0 ... 6 bar

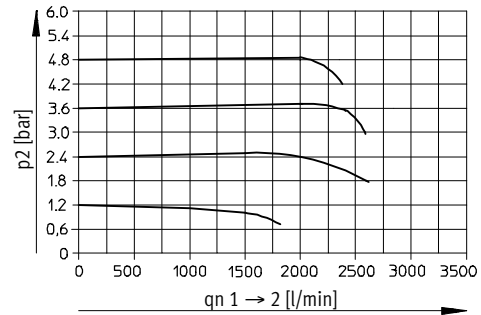

Pressure regulation range 0 ... 10 bar

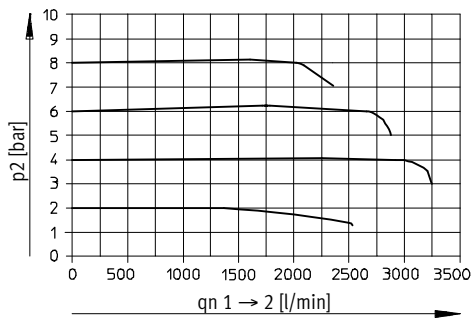

Pneumatic connection G $\frac{1}{2}$

Pressure regulation range 0 ... 2 bar

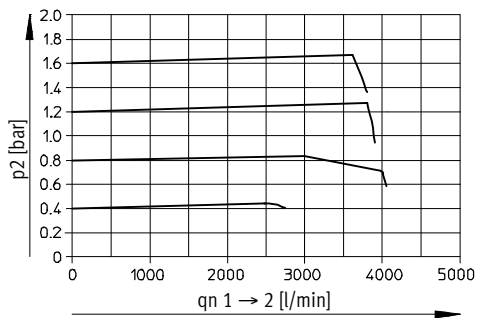

Pressure regulation range 0 ... 6 bar

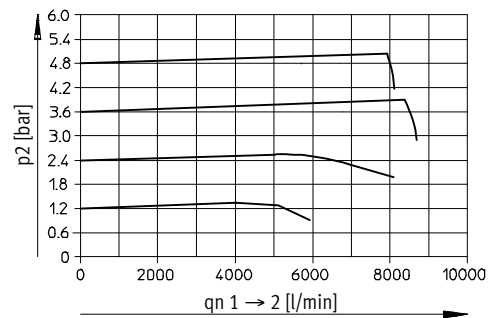

Pressure regulation range 0 ... 10 bar

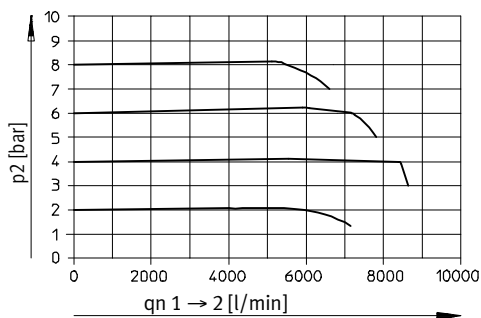

Proportional pressure regulators MPPES

Technical data

Operating and environmental conditions					
Pressure regulation range		[bar]	0 ... 2	0 ... 6	0 ... 10
Operating medium			Compressed air in accordance with ISO 8573-1:2010 [7:4:4] Inert gases		
Note on operating/pilot medium			Operation with lubricated medium possible (in which case lubricated operation will always be required)		
Supply pressure 1		[bar]	3 ... 4	7 ... 8	11 ... 12
Max. pressure hysteresis	1/8"	[mbar]	10		
	1/4"	[mbar]	50		
	1/2"	[mbar]	50		
Ambient temperature		[°C]	0 ... 50		
Temperature of medium		[°C]	0 ... 60		
Corrosion resistance class CRC			2 ¹⁾		
Certification			C-Tick		

1) Corrosion resistance class 2 according to Festo standard 940 070

Components subject to moderate corrosion stress. Externally visible parts with primarily decorative surface requirements which are in direct contact with a normal industrial environment or media such as coolants or lubricating agents.

Electrical data					
Pressure regulation range		[bar]	0 ... 2	0 ... 6	0 ... 10
Electrical connection			Plug, round design to DIN 45 326, M16 x 0.75, 8-pin		
Operating voltage range		U _B	[V DC]	18 ... 30	
Residual ripple			10%		
Power consumption		P _{max.}	[W]	20 (at 30 V DC)	
Setpoint input signal	Voltage	V _w	[V DC]	0 ... 10	
	Current	I _w	[mA]	4 ... 20	
Actual value output signal	Voltage	V _x	[V DC]	0 ... 10	
	Current	I _x	[mA]	4 ... 20	
Protection class to DIN 60 529			IP65 (with connection socket)		
Safety note			Output pressure is not maintained if the power supply cable is interrupted		
Reverse polarity protection	Setpoint input, voltage signal 0 ... 10 V		For all electrical connections		
	Setpoint input, current signal 4 ... 20 mA		For operating voltage		
Protection against short circuit			Yes, for the types with voltage signal as setpoint input		

Materials	
Housing	Wrought aluminium alloy
Seals	NBR

 Note

The working line is vented if the power supply cable is interrupted.

Proportional pressure regulators MPPES

Technical data

FESTO

Dimensions Download CAD data → www.festo.com

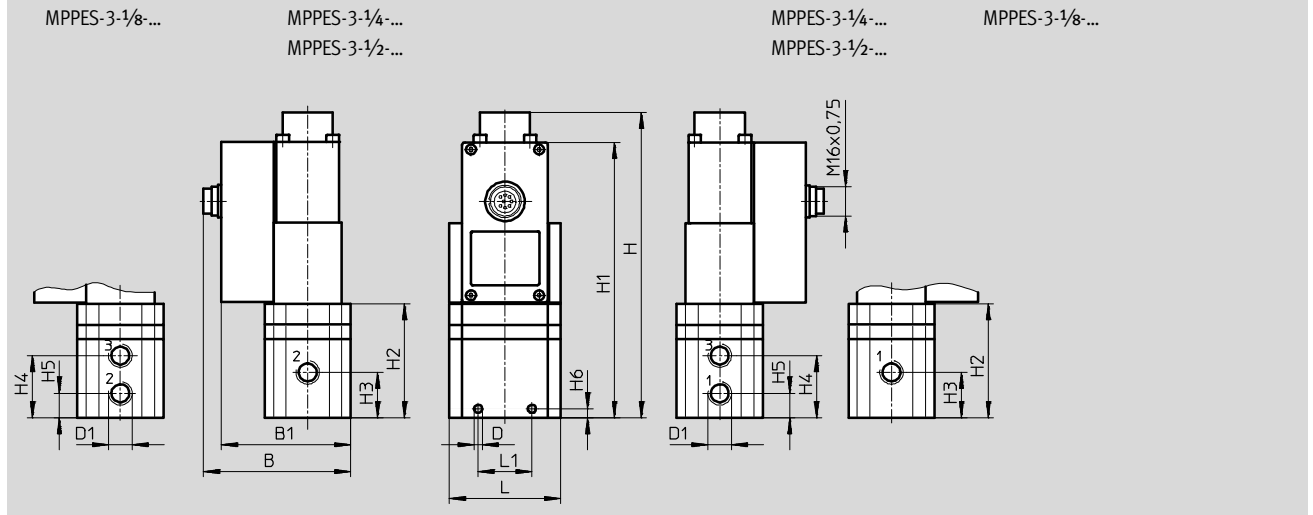

Connection D1	B	B1	∅D	H	H1	H2	H3	H4	H5	H6	L	L1
G $\frac{3}{8}$	77.1	67.1	4.4	116.5	100	55	34	45	23	4	62	34
G $\frac{1}{4}$	82.1	72.1	4.5	170.2	153.7	63.7	25.3	34.8	13.8	5	62	30
G $\frac{1}{2}$	96.1	86.1	7	227.1	210.6	120.6	53	74	32	18	86	50

Connections Switching function

Pin allocation

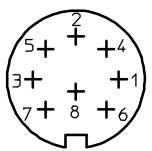

- 1 WH n.c.
- 2 BN GND
- 3 GN GND
- 4 YE W_{in} (setpoint input)
- 5 GY n.c.
- 6 PK X_{out} (actual value output)
- 7 RD 24 V DC (supply voltage)
- 8 BU GND

MPPES-3-1/8-... MPPES-3-1/4-.../MPPES-3-1/2-...

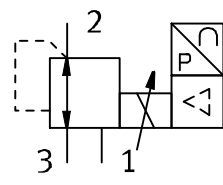
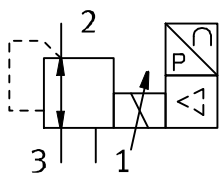

Proportional pressure regulators MPPES



Technical data





Ordering data					
Pneumatic connection	Pressure regulation range [bar]	Voltage type 0 ... 10 V		Current type 4 ... 20 mA	
		Part No.	Type	Part No.	Type
Basic version					
G ¹ / ₈	0 ... 2	187350	MPPES-3-1/8-2-010	187351	MPPES-3-1/8-2-420
	0 ... 6	187352	MPPES-3-1/8-6-010	187353	MPPES-3-1/8-6-420
	0 ... 10	187348	MPPES-3-1/8-10-010	187349	MPPES-3-1/8-10-420
G ¹ / ₄	0 ... 2	187335	MPPES-3-1/4-2-010	187336	MPPES-3-1/4-2-420
	0 ... 6	187337	MPPES-3-1/4-6-010	187338	MPPES-3-1/4-6-420
	0 ... 10	187333	MPPES-3-1/4-10-010	187334	MPPES-3-1/4-10-420
G ¹ / ₂	0 ... 2	187328	MPPES-3-1/2-2-010	187329	MPPES-3-1/2-2-420
	0 ... 6	187330	MPPES-3-1/2-6-010	187331	MPPES-3-1/2-6-420
	0 ... 10	187326	MPPES-3-1/2-10-010	187327	MPPES-3-1/2-10-420
Special adaptation type¹⁾					
G ¹ / ₈	0 ... 10	187347	MPPES-3-1/8-PU-PO-010	187762	MPPES-3-1/8-PU-PO-420
G ¹ / ₄	0 ... 10	187339	MPPES-3-1/4-PU-PO-010	187744	MPPES-3-1/4-PU-PO-420
G ¹ / ₂	0 ... 10	187332	MPPES-3-1/2-PU-PO-010	187735	MPPES-3-1/2-PU-PO-420

1) The special adaptation type allows a lower pressure PU to be assigned to the setpoint 0 V or 4 mA and an upper pressure PO to be assigned to the setpoint 10 V or 20 mA. PU and PO by customer request.

Proportional pressure regulators MPPEs

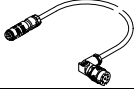
Accessories

FESTO

Ordering data				
	Description	Cable length [m]	Part No.	Type
Connecting cable Technical data → Internet: kvia-mppe				
	<ul style="list-style-type: none"> • Straight plug, M16x0.75, 6-pin • Angled socket, M16x0.75, 8-pin 	5	163882	KVIA-MPPE-5
		10	163883	KVIA-MPPE-10
Plug socket with cable Technical data → Internet: kmppe-b				
	<ul style="list-style-type: none"> • Angled socket, M16x0.75, 8-pin • Open end, 8-wire 	2.5	161879	KMPPE-B-2,5
		5	161878	KMPPE-B-5
Angled socket Technical data → Internet: mppe				
	<ul style="list-style-type: none"> • Angled socket, M16x0.75, 8-pin • Soldered connection, 8-pin 	–	161839	MPPE-3-B
Setpoint module Technical data → Internet: mpz				
	Setpoint module for generating 6 + 1 analogue voltage signals	–	546224	MPZ-1-24DC-SGH-6-SW