

Linear gantries

FESTO

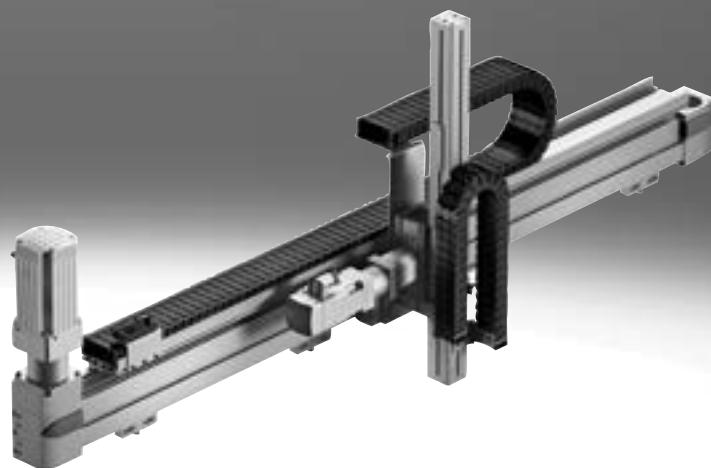

Characteristics

At a glance

A linear gantry (YXCL) is an assembly of several axis modules (EHM.../DHMZ) to produce a movement in 2D space.

The linear gantry facilitates movement in 2D space.

Depending on the requirements, the gantry is either composed of several axis modules (YXCL) or using the linear gantry EXCT (YXML). All of these are tried-and-tested components from Festo.

- Very high requirements for precision and/or very heavy workpieces combined with long strokes (YXCR)
- Cost-effective handling unit in a compact format for small parts handling and simple tasks (YXCR-B)
- Frequently used in feeding or loading applications
- Use of tried-and-tested drives/axes from Festo

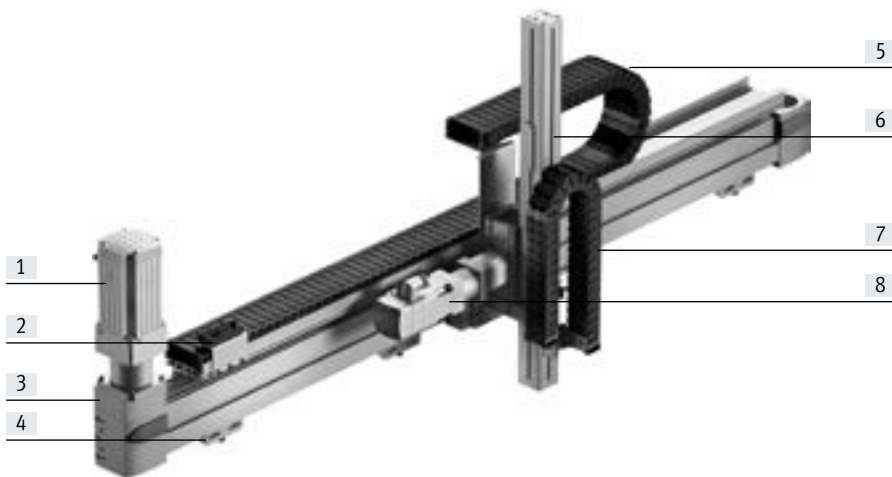

- [1] Servo motor for the Y-module
- [2] Multi-pin plug distributor which collectively transfers all electrical signals such as for end-position sensing
- [3] Y-axis
- [4] Profile mounting/adjusting kit
- [5] Energy chain for the Y-module
- [6] Z-axis
- [7] Energy chain for the Z-module
- [8] Servo motor for the Z-module

Description of the modules

Y-module

Design:

The Y-module EHYM comprises a linear axis which is powered by a servo or stepper motor.

Adapters are mounted on the slides of the Y-axis to connect the Z-module.

The following components are located on the motor side:

- Energy chain (optional)
- Multi-pin plug distributor for proximity switch (if a sensor package has been selected)

Sample image:

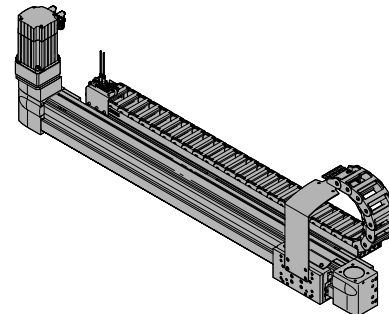

Z-module

Design:

The Z-module EHZM comprises an electric drive, the DHMZ comprises a pneumatic drive. Based on the configuration, an energy chain is optionally installed as a cable guide depending on the axis type and stroke. The Z-module can be selected using the configurator, depending on the application.

Sample image:

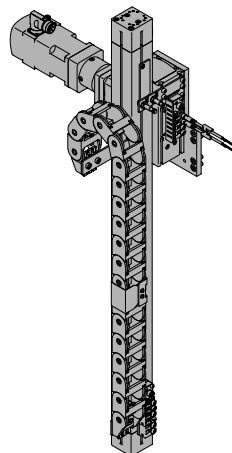

Characteristics

Description of the modules

YZ-module (EXCT)

Design:

Two fixed servo motors drive a toothed belt arranged in a T-shape.

The toothed belt moves the slide of the Y-axis and the interface located on the Z-axis in a 2-dimensional space.

A controller calculates the position of the interface. The controlled interaction of the motors results in the movement of the interface.

Attachment components enable additional processes to be carried out.

Sample image:

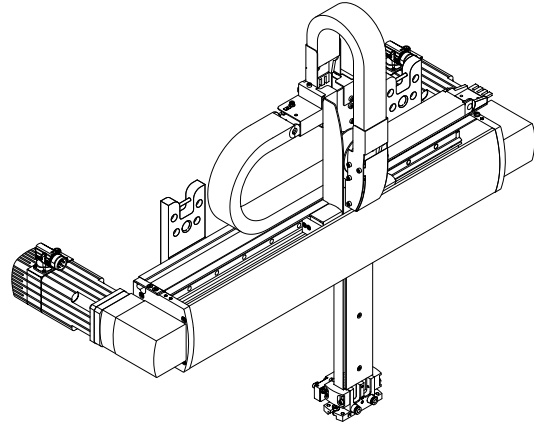

Dispatch options

Fully assembled:

The linear gantry is fully assembled. All cables and tubing are installed and connected.

Partially assembled:

The linear gantry is delivered partially assembled. This means that both axis modules (Y-/Z-axis) are assembled, each with the optional motors. The partially assembled system must be completed by the customer. Help can be found in the assembly instructions provided.

Optional accessories (→ page 10) are enclosed.

Note flatness → table below.

System overview¹⁾

Size	YXCL-1	YXCL-2	YXCL-3	YXCL-4	YXML-1	YXML-2	YXML-3
Max. working stroke	Y: 1900 mm Z: 50 mm	Y: 3000 mm Z: 800 mm	Y: 3000 mm Z: 800 mm	Y: 3000 mm Z: 800 mm	Y: 1000 mm Z: 200 mm	Y: 1500 mm Z: 500 mm	Y: 2000 mm Z: 800 mm
Max. payload	Dependent on the selected dynamic response						
Mounting position	Horizontal						

Size	YXCL-1-B	YXCL-2-B
Max. working stroke	Y: 800 mm Z: 150 mm	Y: 1200 mm Z: 200 mm
Max. payload	Dependent on the selected dynamic response	
Mounting position	Horizontal	

1) Drive package depends on the configuration selected.

Characteristics

Configurator: Handling Guide Online (HGO)

Selecting a handling system

Planning complex handling systems takes a lot of time. You can use the configurator "Handling Guide Online" (HGO) to design a customised handling system for your application in just a few steps.

You can choose from the following systems:

- Single-axis system
- 2D linear gantry
- 2D planar surface gantry
- 3-dimensional gantry
- 3D cantilever system

Advantages:

- Automatic selection of all relevant components
- Automatic design and calculation of the workload
- Quote created automatically
- CAD model available immediately
- Configuration-specific parameters for servo drives available immediately
- Complete Eplan project can be ordered according to the individual configuration
- Fully automated processing
- You can order fully or partially assembled systems through the Online Shop
- Lots of possible options

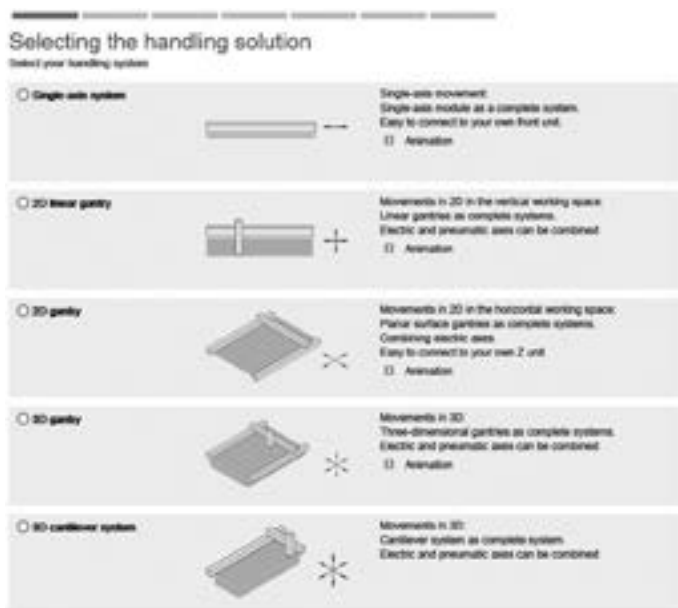

Entering the application data

- Payload
- Drive system of the axis
- Distance from the centre of the load
- Working stroke
- Reference cycle

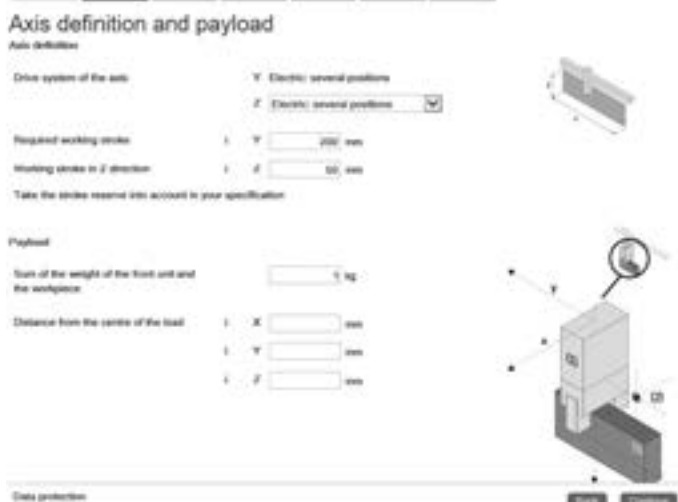

Characteristics

Configurator: Handling Guide Online (HGO)

Result of calculation

You will be offered a selection of systems calculated based on the application data you entered.

The following are available immediately:

- CAD model
- Datasheet of the selected system
- Price information

Result of calculation
Select the appropriate system and continue with the configuration.

No.	System series	System workload (t)	Repetition accuracy (mm)	Your price
<input checked="" type="checkbox"/>	Y004-1	11 %	0.1 mm	
<input type="checkbox"/>	Y004-1	41 %	0.05 mm	
<input type="checkbox"/>	Y004-1	81 %	0.02 mm	
<input type="checkbox"/>	Y004-2	24 %	0.02 mm	
<input type="checkbox"/>	Y004-2	25 %	0.02 mm	

Requires additional motion controller for interpolation (e.g. GPC-E-400-M1-...)

Y1 linear gantry Y004-1-01

Drive module	Y2 module Linear gantry EXCT-15
Kinematics type	Parallel kinematics
Stroke	200 mm/100 mm
Repetition accuracy (mm)	...
Clear width	Without
Type of motor	Servo motor (SAMS-A5)
Motor position	Flow-floor
Motor connection	Power 48 V DC

Data protection Back Continue

System overview

You will be given an overview of the complete system.

You will also have the following options:

- Show price
- Send request
- Add to basket

Your handling solution
Your selected system overview

Exemplary representation



Update CAD Preview

Your system ID:
C1372586

Your next step:

Show price

Send request

Add to basket

Your order | Your system | Your options

Features

Data protection Back

Characteristics

Standard components within the handling system

The handling system comprises a number of tried-and-tested standard components from Festo. Different components are used depending on the configuration. The single axes installed will be displayed in the configurator HGO on the "Result of calculation" page.

Y-axis

Toothed belt axis EGC-TB-KF



- Electric
- Rigid, closed profile
- Recirculating ball bearing guide for high loads and torques
- High dynamic response and minimum vibration

Toothed belt axis ELGC-TB



- Electric
- Optimal installation space to working space ratio
- Protected against external influences by internal guide
- High dynamic response

Spindle axis ELGC-BS



- Electric
- Optimal installation space to working space ratio
- Protected against external influences by internal guide
- Various spindle pitches

Toothed belt axis EGC-HD-TB



- Electric
- Flat drive unit with rigid, closed profile
- Duo guide rail
- For maximum loads and torques, high feed forces and speeds and long service life

Z-axis

Mini slide EGSC



- Electric
- Compact design
- High load capacity
- Precision guide and ball screw drive
- Easy adjustment of end positions

Mini slide EGSL



- Electric
- Compact design
- High load capacity
- High dynamic response
- Easy adjustment of end positions

Mini slide DGST



- Pneumatic
- Precise and resilient roller bearing guide
- Slide and yoke plate as a single component
- High dynamic response

Mini slide DGSL



- Pneumatic
- Flat design
- High load capacity
- High dynamic response
- Easy adjustment of end positions

Spindle axis EGC-BS-KF



- Electric
- Rigid, closed profile
- Recirculating ball bearing guide for high loads and torques
- High dynamic response and minimum vibration
- Various spindle pitches

Characteristics

Possible axis combinations ¹⁾		
Size	Y-module	Z-module
YXCL-1	<ul style="list-style-type: none"> Toothed belt axis EGC-50-TB-KF 	<ul style="list-style-type: none"> Mini slide pneumatic: DGSL-6 electric: EGSL-35
YXCL-1-B	<ul style="list-style-type: none"> Toothed belt axis ELGC-60-TB Spindle axis ELGC-60-BS 	<ul style="list-style-type: none"> Mini slide pneumatic: DGST-12/16 electric: EGSC-45
YXCL-2	<ul style="list-style-type: none"> Toothed belt axis EGC-80-TB-KF Toothed belt axis with heavy-duty guide EGC-HD-125-TB 	<ul style="list-style-type: none"> Mini slide pneumatic: DGSL-12/16 electric: EGSL-45/55 Cantilever axis DGEA-18 Spindle axis EGC-70-BS-KF
YXCL-2-B	<ul style="list-style-type: none"> Toothed belt axis ELGC-80-TB Spindle axis ELGC-80-BS 	<ul style="list-style-type: none"> Mini slide pneumatic: DGST-16/20 electric: EGSC-60
YXCL-3	<ul style="list-style-type: none"> Toothed belt axis EGC-120-TB-KF Toothed belt axis with heavy-duty guide EGC-HD-160-TB 	<ul style="list-style-type: none"> Mini slide pneumatic: DGSL-20/25 electric: EGSL-75 Cantilever axis DGEA-25/40 Spindle axis EGC-80-BS-KF
YXCL-4	<ul style="list-style-type: none"> Toothed belt axis EGC-185-TB-KF Toothed belt axis with heavy-duty guide EGC-HD-220-TB 	<ul style="list-style-type: none"> Cantilever axis DGEA-40 Spindle axis EGC-120-BS-KF
YXML-1	<ul style="list-style-type: none"> Linear gantry EXCT-15 	<ul style="list-style-type: none"> Linear gantry EXCT-15
YXML-2	<ul style="list-style-type: none"> Linear gantry EXCT-30 	<ul style="list-style-type: none"> Linear gantry EXCT-30
YXML-3	<ul style="list-style-type: none"> Linear gantry EXCT-100 	<ul style="list-style-type: none"> Linear gantry EXCT-100

1) Drive package depends on the configuration selected.

Characteristics

Standard components within the handling system

The handling system comprises a number of tried-and-tested standard components from Festo. Different components are used depending on the configuration. You can alter the scope and design of the drive package in the configurator HGO on the "System configuration" page.

Motors and controllers

Servo motors EMMT-AS



- Dynamic, brushless, permanently excited servo motor
- Digital absolute displacement encoder in single-turn or multi-turn version
- With optional brake

Servo motors EMME-AS



- Dynamic, brushless, permanently excited servo motor
- Digital absolute displacement encoder in single-turn or multi-turn version
- With optional brake

Servo motors EMMB-AS



- Dynamic, brushless, permanently excited servo motor
- Digital absolute displacement encoder in single-turn or multi-turn version
- With optional brake

Stepper motors EMMS-ST



- 2-phase hybrid technology
- Step angle 1.8°
- With optional brake

Gear unit EMGA



- Low-backlash planetary gear
- Gear ratio
i = 3 and 5
- Life-time lubrication

Characteristics

Standard components within the handling system

The handling system comprises a number of tried-and-tested standard components from Festo. Different components are used depending on the configuration. You can alter the scope and design of the drive package in the configurator HGO on the "System configuration" page.

Servo drive CMMT-AS, for servo motor



- Universal servo drive
- For synchronous servo motors
- Integrated EMC filters
- Integrated brake chopper
- Integrated braking resistor
- Position controller
- Speed controller
- Force controller
- Range of control functions

Options:

- Safety function: safe torque off (STO)/category 4, Performance Level e
- Safe stop 1 (SS1)
- Safe brake control (SBC) up to SIL3/category 3, Performance Level e

- Bus protocols
 - EtherCAT
 - PROFINET RT/IRT
 - EtherNet/IP
 - Modbus TCP

Servo drive CMMT-ST, for stepper motor



- Servo drive for operating stepper motors and brushless direct current motors
- Options for point-to-point and interpolating motion and for precise positioning
- Primary voltage from 24 ... 48 V DC
- Position controller
- Speed controller
- Force controller
- Range of control functions

Options:

- Safety function: safe torque off (STO)/category 3, Performance Level e
- Safe stop 1 time controlled (SS1-t)

- Bus protocols
 - EtherCAT
 - PROFINET RT/IRT
 - EtherNet/IP
 - Modbus TCP

Ordering data – Accessories

Module/motor combinations

We recommend that the linear gantry is operated with the proposed motors from Festo. These precisely match the mechanical system. When using third-party motors, it is essential that the technical limits are observed.

Module	Motor		Stepper motor	
	Servo motor			
Y-module				
EHMY-...-EGC-50-TB-KF	–	EMME-AS-40-S-LV-...	–	EMMS-ST-57-M-...
EHMY-...-EGC-80-TB-KF	EMMT-AS-60-S-LS-...	EMME-AS-60-M-LS-...	–	EMMS-ST-57-S-...
EHMY-...-EGC-120-TB-KF	EMMT-AS-80-L-LS-...	EMME-AS-80-S-LS-...	–	EMMS-ST-87-S-...
	EMMT-AS-80-L-HS-...	–	–	–
EHMY-...-EGC-125-TB-HD	EMMT-AS-60-L-LS-...	EMME-AS-60-M-LS-...	–	EMMS-ST-57-S-...
EHMY-...-EGC-160-TB-HD	EMMT-AS-80-M-LS-...	EMME-AS-80-S-LS-...	–	EMMS-ST-87-S-...
	EMMT-AS-80-L-HS-...	–	–	–
EHMY-...-EGC-185-TB-KF	EMMT-AS-100-L-HS-...	EMME-AS-100-M-HS-...	–	–
	EMMT-AS-150-M-HV-R3...	–	–	–
EHMY-...-EGC-220-TB-HD	EMMT-AS-100-L-HS-...	EMME-AS-100-M-HS-...	–	–
	EMMT-AS-150-M-HV-R3...	–	–	–
EHMY-LP-ELGC-60-BS	–	–	EMMB-AS-60-04	EMMS-ST-57M
EHMY-LP-ELGC-80-BS	–	–	EMMB-AS-60-04	EMMS-ST-87-M
EHMY-LP-ELGC-60-TB	–	–	EMMB-AS-80-07	EMMS-ST-87-M
EHMY-LP-ELGC-80-TB	–	–	EMMB-AS-80-07	EMMS-ST-87-L
Z-module				
EHMZ-DGEA-18-TB-KF	–	EMME-AS-60-M-LS-...	–	EMMS-ST-57-S-...
EHMZ-DGEA-25-TB-KF	–	EMME-AS-60-M-LS-...	–	EMMS-ST-57-S-...
EHMZ-DGEA-40-TB-KF	–	EMME-AS-80-M-LS-...	–	–
EHMZ-EGC-70-BS-KF	EMMT-AS-60-S-LS-...	EMME-AS-60-M-LS-...	–	EMMS-ST-57-S-...
EHMZ-EGC-80-BS-KF	EMMT-AS-60-M-LS-...	EMME-AS-60-M-LS-...	–	EMMS-ST-57-S-...
EHMZ-EGC-120-BS-KF	EMMT-AS-80-S-LS-...	EMME-AS-80-S-LS-...	–	–
	EMMT-AS-80-M-LS-...	–	–	–
	EMMT-AS-80-S-HS-...	–	–	–
	EMMT-AS-80-L-HS-...	–	–	–
EHMZ-EGSL-35-BS-KF	–	EMME-AS-40-S-LV-...	–	EMMS-ST-28-L-...
EHMZ-EGSL-45-BS-KF	EMMT-AS-60-S-LS-...	EMME-AS-40-S-LV-...	–	EMMS-ST-57-S-...
EHMZ-EGSL-55-BS-KF	EMMT-AS-60-S-LS-...	EMME-AS-60-M-LS-...	–	EMMS-ST-57-S-...
EHMZ-EGSL-75-BS-KF	EMMT-AS-80-S-LS-...	EMME-AS-80-S-LS-...	–	EMMS-ST-87-S-...
EHMZ-EGSC-45	–	–	EMMB-AS-40-01	EMMS-ST-42-S
EHMZ-EGSC-60	–	–	EMMB-AS-60-02	EMMS-ST-57M
YZ-module (EXCT)				
EXCT-15	EMMT-AS-80-M-LS-...	–	–	–
EXCT-30	EMMT-AS-100-M-HS-...	–	–	–
EXCT-100	EMMT-AS-100-M-HS-...	–	–	–

Ordering data – Accessories

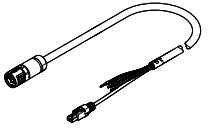
Ordering data	Description	Cable length [m]	Part no.	Type
For servo motor EMMT-AS				
Motor cable				
	• For EMMT-AS-60/80-...-R2... with CMMT-AS	2.5	5251374	NEBM-M23G15-EH-2.5-Q7N-R3LEG14
		5	5251375	NEBM-M23G15-EH-5-Q7N-R3LEG14
		7.5	5251376	NEBM-M23G15-EH-7.5-Q7N-R3LEG14
		10	5251377	NEBM-M23G15-EH-10-Q7N-R3LEG14
		15	5251378	NEBM-M23G15-EH-15-Q7N-R3LEG14
		20	5251379	NEBM-M23G15-EH-20-Q7N-R3LEG14
	• For EMMT-AS-100-...-R3... with CMMT-AS	2.5	5251381	NEBM-M23G15-EH-2.5-Q9N-R3LEG14
		5	5251382	NEBM-M23G15-EH-5-Q9N-R3LEG14
		7.5	5251383	NEBM-M23G15-EH-7.5-Q9N-R3LEG14
		10	5251384	NEBM-M23G15-EH-10-Q9N-R3LEG14
		15	5251385	NEBM-M23G15-EH-15-Q9N-R3LEG14
		20	5251386	NEBM-M23G15-EH-20-Q9N-R3LEG14
	• For EMMT-AS-150-...-R3... with CMMT-AS	2.5	5251395	NEBM-M40G15-EH-2.5-Q11N-R3LEG14
		5	5251396	NEBM-M40G15-EH-5-Q11N-R3LEG14
		7.5	5251397	NEBM-M40G15-EH-7.5-Q11N-R3LEG14
10		5251398	NEBM-M40G15-EH-10-Q11N-R3LEG14	
15		5251399	NEBM-M40G15-EH-15-Q11N-R3LEG14	
20		5251400	NEBM-M40G15-EH-20-Q11N-R3LEG14	

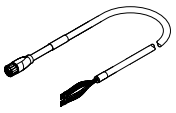
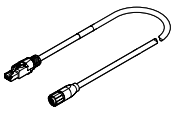

Ordering data	Description	Cable length [m]	Part no.	Type
For servo motor EMME-AS				
Motor cable				
	• For EMME-AS-40/60 with CMMT-AS	2.5	5391541	NEBM-M16G8-E-2.5-Q7-LE8-1
		5	5391543	NEBM-M16G8-E-5-Q7-LE8-1
		7.5	5391548	NEBM-M16G8-E-7.5-Q7-LE8-1
		10	8085952	NEBM-M16G8-E-10-Q7-LE8-1
		15	8085953	NEBM-M16G8-E-15-Q7-LE8-1
		20	611113	NEBM-M16G8-E-20-Q7-LE8-1
	• For EMME-AS-80/100 with CMMT-AS	2.5	5391540	NEBM-M16G8-E-2.5-Q9-LE8-1
		5	5391545	NEBM-M16G8-E-5-Q9-LE8-1
		7.5	5391547	NEBM-M16G8-E-7.5-Q9-LE8-1
		10	5391549	NEBM-M16G8-E-10-Q9-LE8-1
		15	5391550	NEBM-M16G8-E-15-Q9-LE8-1
		20	611114	NEBM-M16G8-E-20-Q9-LE8-1
Encoder cable				
	• For EMME-AS-40/60/80/100 with CMMT-AS	2.5	5212312	NEBM-M12G8-E-2.5-N-R3G8
		5	5212313	NEBM-M12G8-E-5-N-R3G8
		7.5	5212314	NEBM-M12G8-E-7.5-N-R3G8
		10	5212315	NEBM-M12G8-E-10-N-R3G8
		15	5212316	NEBM-M12G8-E-15-N-R3G8
		20	611112	NEBM-M12G8-E-20-N-R3G8

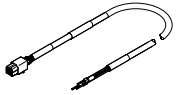
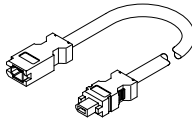
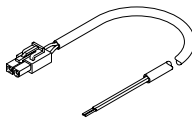
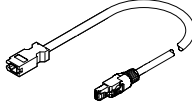
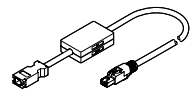
Ordering data – Accessories

Ordering data		Cable length [m]	Part no.	Type
For servo motor EMMB-AS				
Motor cable				
 <ul style="list-style-type: none"> For EMMB-AS-40/60/80 with CMMT-AS 	2.5	5219197	NEBM-H6G4-E-2.5-Q13N-LE4	
	5	5219198	NEBM-H6G4-E-5-Q13N-LE4	
	7.5	5219199	NEBM-H6G4-E-7.5-Q13N-LE4	
	10	5219200	NEBM-H6G4-E-10-Q13N-LE4	
	15	8097203	NEBM-H6G4-E-15-Q13N-LE4	
Encoder cable				
 <ul style="list-style-type: none"> For EMMB-AS-40/60/80 with CMMT-AS 	2.5	5219213	NEBM-REG6-E-2.5-Q14N-REG6	
	5	5219214	NEBM-REG6-E-5-Q14N-REG6	
	7.5	5219215	NEBM-REG6-E-7.5-Q14N-REG6	
	10	5219216	NEBM-REG6-E-10-Q14N-REG6	
	15	8097200	NEBM-REG6-E-15-Q14N-REG6	
Connecting cable for brake				
 <ul style="list-style-type: none"> For EMMB-AS-40/60/80 with CMMT-AS 	2.5	5219205	NEBM-H7G2-E-2.5-Q14N-LE2	
	5	5219206	NEBM-H7G2-E-5-Q14N-LE2	
	7.5	5219207	NEBM-H7G2-E-7.5-Q14N-LE2	
	10	5219208	NEBM-H7G2-E-10-Q14N-LE2	
	15	8097206	NEBM-H7G2-E-15-Q14N-LE2	
Adapter for encoder cable (absolutely essential)				
 <ul style="list-style-type: none"> For EMMB-AS-40/60/80 with CMMT-AS 	For single-turn version with CMMT-AS			
	0.5	8097197	NEFM-REG6-K-0.5-R3G8	
 <ul style="list-style-type: none"> For EMMB-AS-40/60/80 with CMMT-AS 	For multi-turn version with CMMT-AS¹⁾			
	0.5	8097195	NEFM-REG6-K-0.5-B-R3G8	
	For multi-turn version with CMMB-AS¹⁾			
0.5	8097196	NEFM-REG6-K-0.5-B-REG6		

1) The required battery is not included in the scope of delivery

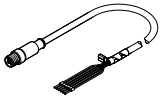
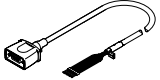
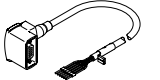
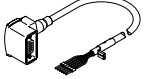
Ordering data – Accessories

Designation	Description	Cable length [m]	Part no.	Type
For stepper motor EMMS-ST				
Motor cable¹⁾				
	• For stepper motor EMMS-ST-28 with CMMT-ST	1.5	1449600	NEBM-SM12G8-E-1.5-Q5-LE6
		2.5	1449601	NEBM-SM12G8-E-2.5-Q5-LE6
		5	1449602	NEBM-SM12G8-E-5-Q5-LE6
		7	1449603	NEBM-SM12G8-E-7-Q5-LE6
		10	1449604	NEBM-SM12G8-E-10-Q5-LE6
		15	5105618	NEBM-SM12G8-E-15-Q5-LE6
	• For stepper motor EMMS-ST-42/57 with CMMT-ST • Straight plug	2.5	1450369	NEBM-S1G9-E-2.5-Q5-LE6
		5	1450370	NEBM-S1G9-E-5-Q5-LE6
		7	1450371	NEBM-S1G9-E-7-Q5-LE6
		10	1450372	NEBM-S1G9-E-10-Q5-LE6
		15	5085055	NEBM-S1G9-E-15-Q5-LE6
		20	5085056	NEBM-S1G9-E-20-Q5-LE6
	• For stepper motor EMMS-ST-42/57 with CMMT-ST • Angled plug	2.5	1450737	NEBM-S1W9-E-2.5-Q5-LE6
		5	1450738	NEBM-S1W9-E-5-Q5-LE6
		7	1450739	NEBM-S1W9-E-7-Q5-LE6
		10	1450740	NEBM-S1W9-E-10-Q5-LE6
		15	610856	NEBM-S1W9-E-15-Q5-LE6
	• For stepper motor EMMS-ST-87 with CMMT-ST • Angled plug	2.5	1450944	NEBM-S1W15-E-2.5-Q7-LE6
		5.0	1450945	NEBM-S1W15-E-5-Q7-LE6
		7.0	1450946	NEBM-S1W15-E-7-Q7-LE6
		10	1450947	NEBM-S1W15-E-10-Q7-LE6
		15	610857	NEBM-S1W15-E-15-Q7-LE6
Encoder cable¹⁾				
	• For stepper motor EMMS-ST-28/42/57/87 with CMMT-ST • Straight plug	2.5	1451587	NEBM-M12G8-E-2.5-LE8
		5	1451588	NEBM-M12G8-E-5-LE8
		7	1451589	NEBM-M12G8-E-7-LE8
		10	1451590	NEBM-M12G8-E-10-LE8
		15	611110	NEBM-M12G8-E-15-LE8
	• For stepper motor EMMS-ST-28/42/57/87 with CMMT-ST • Angled plug	2.5	1451675	NEBM-M12W8-E-2.5-LE8
		5	1451676	NEBM-M12W8-E-5-LE8
		7	1451677	NEBM-M12W8-E-7-LE8
		10	1451678	NEBM-M12W8-E-10-LE8
		15	610858	NEBM-M12W8-E-15-LE8

1) Cables especially suitable for the motor controller and motor.
Degree of protection to IP65 (in assembled state)

Possible cable and tube lengths

- Cables and tubing are selected so that the length specified when ordering will be the minimum connection length from the energy chain output.
- Cables and tubing are only available in fixed lengths as stated in the table below. This can mean that the cable plugs of the different cables do not end at the same point.

Length	1 m	2 m	5 m	7 m	10 m
Motor cable	–	■	■	■	■
Encoder cable	–	■	■	■	■
Multi-pin plug connecting cable	–	■	■	■	■
Tubing (for DHMZ only)	■	■	■	–	–

Ordering data – Accessories

Standard components within the handling system



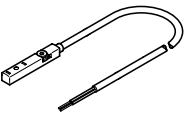
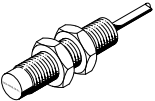
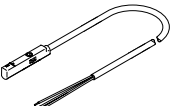

The handling system comprises a number of tried-and-tested standard components from Festo. Different components are used depending on the configuration. You can alter the scope and design of the accessories in the configurator HGO on the "System configuration" page.

Designation	Description	Cable length [m]	Part no.	Type	
Proximity switch (inductive) for sensing the position of the slide on the Y-/Z-axis					
	Cable with open end				
	<ul style="list-style-type: none"> For toothed belt axis EGC-TB, EGC-HD-TB For toothed belt axis ELGC-TB For spindle axis ELGC-BS For spindle axis EGC-BS For mini slide EGSL For mini slide EGSC For DC voltage Included if the "Festo sensor package" is selected: <ul style="list-style-type: none"> For EGC: 2 pieces For EGSL, EGSC: 1 piece 	PNP, N/C contact	7.5	551391	SIES-8M-PO-24V-K-7.5-OE
		PNP, N/O contact	7.5	551386	SIES-8M-PS-24V-K-7.5-OE
		NPN, N/C contact	7.5	551401	SIES-8M-NO-24V-K-7.5-OE
		NPN, N/O contact	7.5	551396	SIES-8M-NS-24V-K-7.5-OE
Proximity switch (inductive) for sensing the position of the slide on the Z-axis					
	Cable with open end				
	<ul style="list-style-type: none"> For cantilever axis DGEA For DC voltage Included if the "Festo sensor package" is selected: <ul style="list-style-type: none"> 2 pieces 	PNP, N/C contact	2.5	150398	SIEN-M8NB-PO-K-L
		PNP, N/O contact	2.5	150394	SIEN-M8NB-PS-K-L
		NPN, N/C contact	2.5	150396	SIEN-M8NB-NO-K-L
NPN, N/O contact		2.5	150392	SIEN-M8NB-NS-K-L	
Proximity switches (magneto-resistive) for sensing the position of the slide on the Z-axis					
	Cable with open end				
	<ul style="list-style-type: none"> For mini slide DGSL For DC voltage Included if the "Festo sensor package" is selected: <ul style="list-style-type: none"> 2 pieces 	PNP, N/O contact	2.5	551373	SMT-10M-PS-24V-E-2.5-L-OE
NPN, N/O contact		2.5	551377	SMT-10M-NS-24V-E-2.5-L-OE	

Ordering data – Accessories

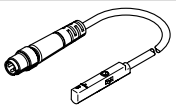
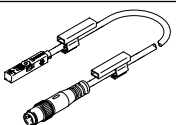
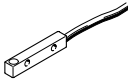
Standard components within the handling system

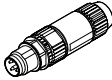
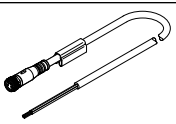
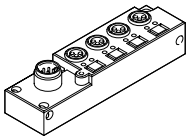
The handling system comprises a number of tried-and-tested standard components from Festo. Different components are used depending on the configuration. You can alter the scope and design of the accessories in the configurator HGO on the "System configuration" page.

Designation	Description	Cable length [m]	Part no.	Type	
Proximity switches (magnetoresistive) for sensing the position of the slide on the Z-axis					
	<ul style="list-style-type: none"> For mini slide DGST-8/-12 For DC voltage Included if the "Festo sensor package" is selected: <ul style="list-style-type: none"> 2 pieces 	PNP, N/O contact	2.5	551375	SMT-10M-PS-24V-E-0.3-L-M8D
		NPN, N/O contact	2.5	551379	SMT-10M-NS-24V-E-0.3-L-M8D
	<ul style="list-style-type: none"> For mini slide DGST-16/-20 For DC voltage Included if the "Festo sensor package" is selected: <ul style="list-style-type: none"> 2 pieces 	PNP, N/O contact	2.5	574334	SMT-8M-A-PS-24V-E-0.3-M8D
		NPN, N/O contact	2.5	574339	SMT-8M-A-NS-24V-E-0.3-L-M8D
Proximity switch for sensing the position of the slide on the Y-/Z-axis					
	<ul style="list-style-type: none"> For EXCT For DC voltage For sensing kit EAPR-E17 	PNP, N/C contact	2.5	174552	SIES-Q8B-PO-K-L
		PNP, N/O contact	2.5	178294	SIES-Q8B-PS-K-L
		NPN, N/C contact	2.5	174550	SIES-Q8B-NO-K-L
		PNP, N/O contact	2.5	178292	SIES-Q8B-NS-K-L
Plug socket with cable					
	<ul style="list-style-type: none"> Connection between multi-pin plug distributor NEDU and control cabinet 	5	525618	SIM-M12-8GD-5-PU	
		10	570008	SIM-M12-8GD-10-PU	
Plug socket with cable					
	<ul style="list-style-type: none"> For EXCT For multi-pin set EADH 	15	8048086	NEBU-M12W8-K-15-N-LE8	
Plug					
	<ul style="list-style-type: none"> For connection to the multi-pin plug distributor NEDU / distributor NEDY 	–	562024	NECU-S-M8G3-HX	
Connecting cable					
	<ul style="list-style-type: none"> Connection between distributor NEDY and control cabinet 	2.5	541342	NEBU-M8G4-K-2.5-LE4	
		5	541343	NEBU-M8G4-K-5-LE4	
		7.5	610854	NEBU-M8G4-K-7.5-LE4	
		10	589560	NEBU-M8G4-K-10-LE4	
		15	610855	NEBU-M8G4-K-15-LE4	
Multi-pin plug distributor					
	<ul style="list-style-type: none"> With the help of the multi-pin plug distributor, electrical signals such as for end-position sensing can be transferred collectively Options: <ul style="list-style-type: none"> 4 individual connections 6 individual connections 	–	574586	NEDU-L4R1-M8G3L-M12G8	
			574587	NEDU-L6R1-M8G3L-M12G8	
	<ul style="list-style-type: none"> With the help of the distributor, electrical signals such as for end-position sensing can be transferred collectively 2 individual connections 	–	8005312	NEDY-L2R1-V1-M8G3-N-M8G4	

Ordering data – Accessories

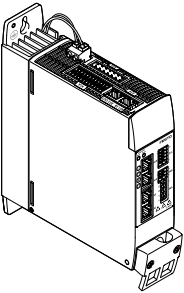
Designation	Description
Motor controller/servo drive	
	<p>The accessories for the relevant motor controllers/servo drives can be found at:</p> <ul style="list-style-type: none"> • www.festo.com/catalogue/cmmt

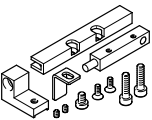
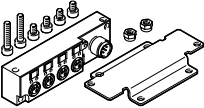
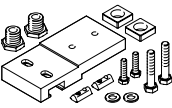
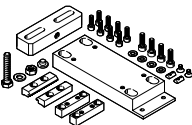
Designation	Description	Part no.	Type
Sensing kit			
	<ul style="list-style-type: none"> • For EXCT • Included in the scope of delivery: proximity switch SIES-Q8B, sensor bracket, switch lug, mounting bracket and screws 	PNP, N/C contact	8092368 EAPR-E17-S1
		PNP, N/O contact	2478427 EAPR-E17-S
		NPN, N/C contact	8092369 EAPR-E17-S3
		NPN, N/O contact	8092370 EAPR-E17-S4
Multi-pin set			
	<ul style="list-style-type: none"> • For EXCT • For connecting up to 4 inputs/outputs 	2972137	EADH-E17-MP1
Mounting kit			
	<ul style="list-style-type: none"> • For EXCT • For mounting and aligning on a supporting surface • The kit is height-adjustable 	EXCT-15	3838164 EAHM-E17-K2-15
		EXCT-30	3838337 EAHM-E17-K2-30
		EXCT-100	3838404 EAHM-E17-K2-100
Adjusting kit			
	<ul style="list-style-type: none"> • Used to mount the handling system on a vertical surface • Once mounted, the axis can be aligned horizontally 	EHMY-...-EGC-50-TB-KF	8047576 EADC-E16-50-E7
		EHMY-...-EGC-80-TB-KF	8047577 EADC-E16-80-E7
		EHMY-...-EGC-120-TB-KF	8047578 EADC-E16-120-E7
		EHMY-...-EGC-185-TB-KF	8047579 EADC-E16-185-E7
		EHMY-...-EGC-125-TB-HD	8047580 EADC-E16-125-E14
		EHMY-...-EGC-160-TB-HD	8047581 EADC-E16-160-E14
		EHMY-...-EGC-220-TB-HD	8047582 EADC-E16-220-E14
		EHMY-...-ELGC-60-BS	8142654 EADC-E16-60-E22
EHMY-...-ELGC-80-BS	8142655 EADC-E16-80-E22		

Programming aid

Festo Automation Suite

Parameterisation and programming software for electronic devices from Festo

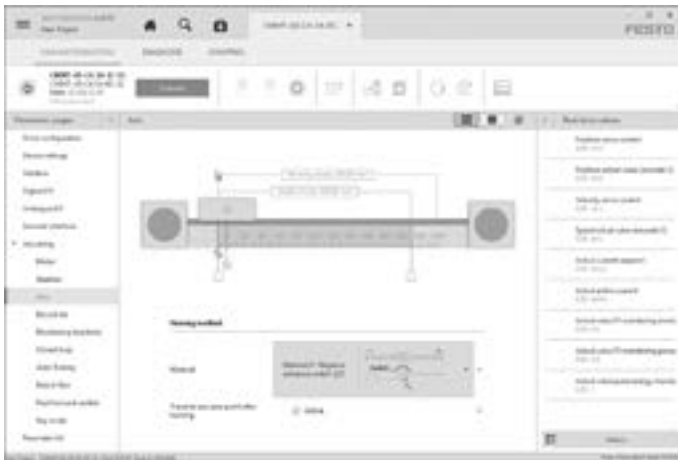

- Parameterisation, programming and commissioning in a clear and user-friendly interface
- Optimum support for complex processes thanks to guided wizards (e.g. for commissioning, drive configuration, etc.)
- Fast access to the required documents and additional information
- Easy integration of electric drives in the controller programming