

Filter regulators LFR/LFRS, D series

FESTO

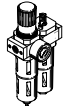

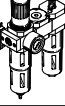

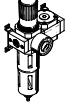
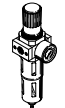
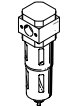
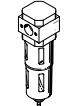
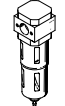
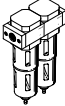
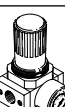

Product range overview – Service unit components, D series, metal

Type	Size	Pneumatic connection										Pressure regulation range [bar]			Grade of filtration [µm]				
		M5	M7	G1/8	G1/4	G3/8	G1/2	G3/4	G1	QS4	QS6	0.5 ...	0.5 ...	2.5 ...	0.01	1	5	40	
Service units																			
FRC/FRCS 	Mini	-	-	■	■	■	-	-	-	-	-	■	■	-	-	-	■	■	
	Midi	-	-	-	■	■	■	■	-	-	-	■	■	-	-	-	■	■	
	Maxi	-	-	-	-	-	■	■	■	-	-	■	■	-	-	-	■	■	
FRC-K 	Micro	-	-	-	-	-	-	-	-	-	-	-	-	-	-	-	-	-	
	Mini	-	-	■	■	-	-	-	-	-	-	■	■	-	-	-	-	■	
	Midi	-	-	-	■	■	■	-	-	-	-	■	■	-	-	-	-	■	
	Maxi	-	-	-	-	-	■	■	-	-	-	■	■	-	-	-	-	■	
LFR-K 	Micro	-	-	-	-	-	-	-	-	-	-	-	-	-	-	-	-	-	
	Mini	-	-	■	■	-	-	-	-	-	-	■	■	-	-	-	-	■	
	Midi	-	-	-	■	■	■	-	-	-	-	■	■	-	-	-	-	■	
	Maxi	-	-	-	-	-	■	■	-	-	-	■	■	-	-	-	-	■	
Individual devices																			
Filter regulators LFR/LFRS 	Mini	-	-	■	■	■	-	-	-	-	-	■	■	-	-	-	■	■	
	Midi	-	-	-	■	■	■	■	-	-	-	■	■	-	-	-	■	■	
	Maxi	-	-	-	-	-	■	■	■	-	-	■	■	-	-	-	■	■	
Filter LF 	Mini	-	-	■	■	■	-	-	-	-	-	-	-	-	-	-	■	■	
	Midi	-	-	-	■	■	■	■	-	-	-	-	-	-	-	-	-	■	■
	Maxi	-	-	-	-	-	■	■	■	-	-	-	-	-	-	-	-	■	■
Fine and micro filters LFMA/LFMB 	Micro	-	-	-	-	-	-	-	-	-	-	-	-	-	-	-	-	-	
	Mini	-	-	■	■	■	-	-	-	-	-	-	-	-	■	■	-	-	
	Midi	-	-	-	■	■	■	■	-	-	-	-	-	-	■	■	-	-	
	Maxi	-	-	-	-	-	■	■	■	-	-	-	-	-	■	■	-	-	
Activated carbon filter LFX 	Micro	-	-	-	-	-	-	-	-	-	-	-	-	-	-	-	-	-	
	Mini	-	-	■	■	■	-	-	-	-	-	-	-	-	-	-	-	-	
	Midi	-	-	-	■	■	■	■	-	-	-	-	-	-	-	-	-	-	
Filter combinations LFMB 	Micro	-	-	-	-	-	-	-	-	-	-	-	-	-	-	-	-	-	
	Mini	-	-	■	■	■	-	-	-	-	-	-	-	-	■	■	-	-	
	Midi	-	-	-	■	■	■	■	-	-	-	-	-	-	■	■	-	-	
Pressure regulators LR/LRS 	Micro	-	-	-	-	-	-	-	-	-	-	-	-	-	-	-	-	-	
	Mini	-	-	■	■	■	-	-	-	-	-	■	■	-	-	-	-	-	
	Midi	-	-	-	■	■	■	■	-	-	-	■	■	-	-	-	-	-	
Maxi	Maxi	-	-	-	-	-	■	■	■	-	-	■	■	-	-	-	-	-	

Product range overview – Service unit components, D series, metal

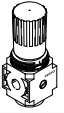
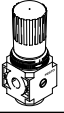
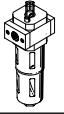
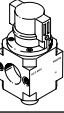
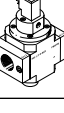
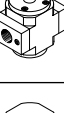
Type	Size	Bowl guard		Condensate drain			Pressure indication		Actuator lock		Supply voltage			Options			→ Page/ Internet
		Metal bowl guard	Plastic bowl	Manual	Semi-automatic	Fully automatic	With pressure gauge	Without pressure gauge	Rotary knob with latch	Rotary knob with integrated lock	24 V DC	110 V AC	230 V AC	Directly actuated pressure regulator with integrated return flow function	Pilot actuated pressure regulator with integrated return flow function	Differential pressure display	
Service units																	
FRC/FRCS	Mini	■	-	■	-	■	■	■	■	■	-	-	-	-	-	-	frc
	Midi	■	-	■	-	■	■	■	■	■	-	-	-	-	-	-	
	Maxi	■	-	■	-	■	■	■	■	■	-	-	-	■	■	-	
FRC-K	Micro	-	-	-	-	-	-	-	-	-	-	-	-	-	-	-	frc
	Mini	■	-	■	-	■	■	-	■	-	■	-	-	-	-	-	
	Midi	■	-	■	-	■	■	-	■	-	■	-	-	-	-	-	
	Maxi	■	-	■	-	■	■	-	■	-	■	-	-	■	■	-	
LFR-K	Micro	-	-	-	-	-	-	-	-	-	-	-	-	-	-	-	frc
	Mini	■	-	■	-	■	■	-	■	■	■	-	-	-	-	-	
	Midi	■	-	■	-	■	■	-	■	■	■	-	-	-	-	-	
	Maxi	■	-	■	-	■	■	-	■	■	■	-	-	■	■	-	
Individual devices																	
Filter regulators LFR/LFRS	Mini	■	-	■	-	■	■	■	■	■	-	-	-	-	-	-	6
	Midi	■	-	■	-	■	■	■	■	■	-	-	-	-	-	-	
	Maxi	■	-	■	-	■	■	■	■	■	-	-	-	■	■	-	
Filter LF	Mini	■	-	■	-	■	-	-	-	-	-	-	-	-	-	-	lf
	Midi	■	-	■	-	■	-	-	-	-	-	-	-	-	-	-	
	Maxi	■	-	■	-	■	-	-	-	-	-	-	-	-	-	-	
Fine and micro filters LFMA/LFMB	Micro	-	-	-	-	-	-	-	-	-	-	-	-	-	-	-	lfma, lfmb
	Mini	■	-	■	-	■	-	-	-	-	-	-	-	-	-	■	
	Midi	■	-	■	-	■	-	-	-	-	-	-	-	-	-	■	
	Maxi	■	-	■	-	■	-	-	-	-	-	-	-	-	-	■	
Activated carbon filter LFX	Micro	-	-	-	-	-	-	-	-	-	-	-	-	-	-	-	lfx
	Mini	■	-	-	-	-	-	-	-	-	-	-	-	-	-	-	
	Midi	■	-	-	-	-	-	-	-	-	-	-	-	-	-	-	
	Maxi	■	-	-	-	-	-	-	-	-	-	-	-	-	-	-	
Filter combinations LFMBA	Micro	-	-	-	-	-	-	-	-	-	-	-	-	-	-	-	lfmba
	Mini	■	-	■	-	■	-	-	-	-	-	-	-	-	-	■	
	Midi	■	-	■	-	■	-	-	-	-	-	-	-	-	-	■	
	Maxi	■	-	■	-	■	-	-	-	-	-	-	-	-	-	■	
Pressure regulators LR/LRS	Mini	-	-	-	-	-	■	■	■	■	-	-	-	■	-	-	lr
	Midi	-	-	-	-	-	■	■	■	■	-	-	-	■	-	-	
	Maxi	-	-	-	-	-	■	■	■	■	-	-	-	■	■	-	

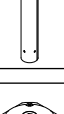
Product range overview – Service unit components, D series, metal

Type	Size	Pneumatic connection										Pressure regulation range [bar]		
		M5	M7	G1/8	G1/4	G3/8	G1/2	G3/4	G1	QS4	QS6	0.5 ... 7	0.5 ... 12	
Individual devices														
Pressure regulators LRB/LRBS		Micro	–											
		Mini	–	–	–	■	–	–	–	–	–	–	■	■
		Midi	–	–	–	–	■	–	–	–	–	–	■	■
		Maxi	–											
Pressure regulator manifolds LRB-K		Micro	–											
		Mini	–	–	–	■	■	–	–	–	–	–	■	■
		Midi	–	–	–	–	■	■	–	–	–	–	■	■
		Maxi	–											
Lubricators LOE		Mini	–	–	■	■	■	–	–	–	–	–	–	
		Midi	–	–	–	■	■	■	■	–	–	–	–	
		Maxi	–	–	–	–	–	■	■	■	–	–	–	
On/off valves HE		Micro	–											
		Mini	–	–	■	■	■	–	–	–	–	–	–	
		Midi	–	–	–	■	■	■	■	–	–	–	–	
		Maxi	–	–	–	–	–	■	■	■	–	–	–	
On/off valves HEE		Micro	–											
		Mini	–	–	■	■	■	–	–	–	–	–	–	
		Midi	–	–	–	■	■	■	■	–	–	–	–	
		Maxi	–	–	–	–	–	■	■	■	–	–	–	
On/off valves HEP		Micro	–											
		Mini	–	–	■	■	■	–	–	–	–	–	–	
		Midi	–	–	–	■	■	■	■	–	–	–	–	
		Maxi	–	–	–	–	–	■	■	■	–	–	–	
Soft-start valves HEL		Micro	–											
		Mini	–	–	■	■	■	–	–	–	–	–	–	
		Midi	–	–	–	■	■	■	■	–	–	–	–	
		Maxi	–	–	–	–	–	■	■	■	–	–	–	
Membrane air dryers LDM1		Micro	–											
		Mini	–											
		Midi	–											
		Maxi	–	–	–	–	–	■	■	■	–	–	–	
Branching modules FRM		Micro	–											
		Mini	–	–	■	■	■	–	–	–	–	–	–	
		Midi	–	–	–	■	■	■	■	–	–	–	–	
		Maxi	–	–	–	–	–	■	■	■	–	–	–	
Distributor block FRZ		Mini	–	–	–	–	–	–	–	–	–	–	–	
		Midi	–	–	–	–	–	–	–	–	–	–	–	
		Maxi	–	–	–	–	–	–	–	–	–	–	–	

Product range overview – Service unit components, D series, metal

Type	Size	Bowl guard		Pressure indication		Actuator lock		Supply voltage			Options		→ Page/ Internet	
		Metal bowl guard	Plastic bowl	With pressure gauge	Without pressure gauge	Rotary knob with latch	Rotary knob with integrated lock	24 V DC	110 V AC	230 V AC	With non-return function	Pressure switch		
Individual devices														
Pressure regulators LRB/LRBS	Micro	-				■	■	■	-	-	-	-	-	lrb
	Mini	-	-	-	■	■	■	-	-	-	-	-	-	
	Midi	-	-	-	■	■	■	-	-	-	-	-	-	
	Maxi	-	-											
Pressure regulator manifolds LRB-K	Micro	-												lrb
	Mini	-	-	-	■	■	-	-	-	-	-	-	-	
	Midi	-	-	-	■	■	-	-	-	-	-	-	-	
	Maxi	-	-											
Lubricators LOE	Mini	■	-	-	■	-	-	-	-	-	-	-	-	loe
	Midi	■	-	-	■	-	-	-	-	-	-	-	-	
	Maxi	■	-	-	■	-	-	-	-	-	-	-	-	
On/off valves HE	Micro	-												he
	Mini	-	-	-	■	■	-	-	-	-	-	-	-	
	Midi	-	-	-	■	■	-	-	-	-	-	-	-	
	Maxi	-	-	-	■	■	-	-	-	-	-	-	-	
On/off valves HEE	Micro	-												hee
	Mini	-	-	-	■	-	-	■	■	■	-	-	-	
	Midi	-	-	-	■	-	-	■	■	■	-	-	-	
	Maxi	-	-	-	■	-	-	■	■	■	-	-	-	
On/off valves HEP	Micro	-												hep
	Mini	-	-	-	■	-	-	-	-	-	-	-	-	
	Midi	-	-	-	■	-	-	-	-	-	-	-	-	
	Maxi	-	-	-	■	-	-	-	-	-	-	-	-	
Soft-start valves HEL	Micro	-												hel
	Mini	-	-	-	■	-	-	-	-	-	-	-	-	
	Midi	-	-	-	■	-	-	-	-	-	-	-	-	
	Maxi	-	-	-	■	-	-	-	-	-	-	-	-	
Membrane air dryers LDM1	Micro	-												ldm1
	Mini	-												
	Midi	-												
	Maxi	■	-	-	■	-	-	-	-	-	-	-	-	
Branching modules FRM	Micro	-												frm
	Mini	-	-	-	■	-	-	-	-	-	■	■		
	Midi	-	-	-	■	-	-	-	-	-	■	■		
	Maxi	-	-	-	■	-	-	-	-	-	■	■		
Distributor block FRZ	Mini	-	-	-	■	-	-	-	-	-	-	-	-	frz
	Midi	-	-	-	■	-	-	-	-	-	-	-	-	
	Maxi	-	-	-	■	-	-	-	-	-	-	-	-	

Peripherals overview

Mini/Midi/Maxi

Filter regulator LFR

Filter regulator LFRS lockable

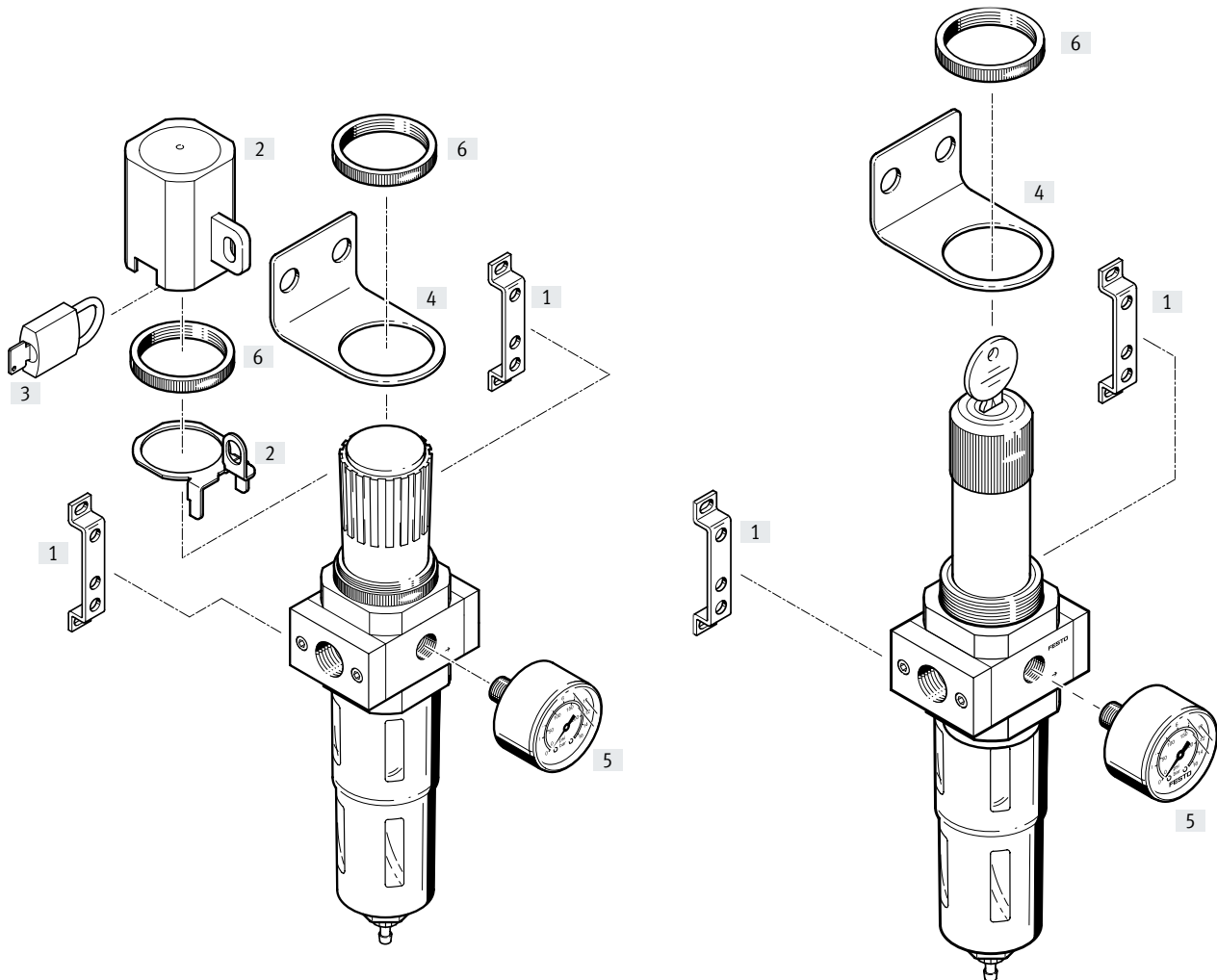

Mounting attachments and accessories

	Rotary knob with latch	Rotary knob, lockable	→ Page/Internet
[1] Mounting bracket HFOE	■	■	hfoe-d
[2] Regulator lock LRVS	■	-	lrvs-d
[3] Padlock LRVS-D	■	-	lrvs-d
[4] Mounting bracket HR-D	■	■	hr-d
[5] Pressure gauge MA	■	■	26
[6] Knurled nut (included in the scope of delivery) HMR	■	■	-

Type codes

001	Series
LFR	Filter regulator
LFRS	Filter regulator, lockable

002	Pneumatic connection
1/8	Female thread G1/8
1/4	Female thread G1/4
3/8	Female thread G3/8
1/2	Female thread G1/2
3/4	Female thread G3/4
1	Female thread G1

003	Version
D	D series, metal

004	Pressure regulation range
7	0.5 ... 7 bar (0.05 ... 0.7 MPa)
	0.5 ... 12 bar (0.05 ... 1.2 MPa)

005	Grade of filtration
	40 µm
5M	5 µm

006	Pressure gauge
	With pressure gauge
0	Without pressure gauge

007	Function
	Directly actuated pressure regulator (MICRO, MINI, MIDI), pilot actuated pressure regulator (only MAXI)
DI	Directly actuated pressure regulator with integrated return flow function (only MAXI)

008	Size
MINI	Grid dimension 40 mm (without connecting plates)
MIDI	Grid dimension 55 mm (without connecting plates)
MAXI	Grid dimension 66 mm (without connecting plates)

009	Condensate drain
	Manually rotating
A	Fully automatic

010	Display unit
	Bar/psi/without
MPA	MPa

Datasheet

LFR/LFRS

Condensate drain, manual, with pressure gauge

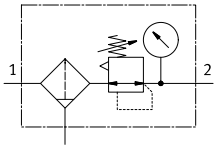

LFR/LFRS-...-DI-MAXI

Condensate drain, manual, with pressure gauge

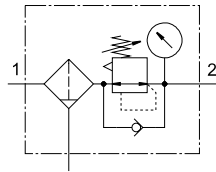

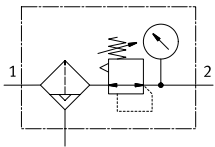

Condensate drain, semi- or fully automatic, with pressure gauge

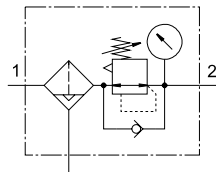

Condensate drain, fully automatic, with pressure gauge



-  Flow rate
110 ... 11000 l/min
-  Temperature range
-10 ... +60 °C
-  Operating pressure
1 ... 16 bar

- Space-saving design with filter and regulator in a single unit
- Good particle separation and high flow rate
- Good regulation characteristics with minimal hysteresis
- Two pressure regulation ranges: 0.5°... 7 bar and 0.5 ... 12 bar
- Two pressure gauge connections for flexible installation
- Setting values are secured by locking the rotary knob
- Choice of manual, semi-automatic or fully automatic condensate drain
- Choice of 5 µm or 40 µm filter inserts
- New filter cartridges → page 25
- Pressure sensor (optional) → page 26

General technical data			
Size	Mini	Midi	Maxi
Pneumatic port 1, 2 ¹⁾	G1/8, G1/4, G3/8	G1/4, G3/8, G1/2, G3/4	G1/2, G3/4, G1
Design	Filter regulator with/without pressure gauge		
Type of mounting	Via accessories In-line installation		
Mounting position	Vertical ±5°		
Grade of filtration [µm]	5 40		
Air purity class at the output	Compressed air to ISO 8573-1:2010 [6:8:4] (grade of filtration 5 µm) Compressed air to ISO 8573-1:2010 [7:8:4] (grade of filtration 40 µm) Inert gases		
Bowl guard	Metal bowl guard		
Condensate drain	Manual Fully automatic		
Actuator lock	Rotary knob with latch Rotary knob with integrated lock		
Pressure regulation range [bar]	0.5 ... 7 0.5 ... 12		
Max. pressure hysteresis [bar]	0.2		0.4
Pressure indication	With pressure gauge Prepared for G1/8 Prepared for G1/4 Prepared for G1/4		
Max. condensate volume [cm ³]	22	43	80 ²⁾

1) Connecting plates with threaded connection
 2) The max. condensate volume for the LFR/LFRS-...-DI-MAXI is 43 cm³.
 † Note: This product corresponds to ISO 1179-1 and ISO 228-1.

Datasheet

Standard nominal flow rate $q_{N}^{1)}$ [l/min]											
Size		Mini			Midi			Maxi			
Pneumatic port 1, 2		G1/8	G1/4	G3/8	G1/4	G3/8	G1/2	G3/4	G1/2	G3/4	G1
Pressure regulation range, grade of filtration	0.5 ... 7 bar, 40 μ m	900	1500	1700	2100	3200	3900	4000	9500 (7600) ²⁾	10000 (7700) ²⁾	11000 (7800) ²⁾
	0.5 ... 12 bar, 5 μ m	650	1200	1350	1600	2400	2600	2600	7500 (4000) ²⁾	7600 (5800) ²⁾	8000 (6000) ²⁾
	0.5 ... 12 bar, 40 μ m	750	1400	1600	2000	3100	3400	3400	9400 (4500) ²⁾	9700 (6800) ²⁾	10000 (7000) ²⁾

1) Measured at $p_1 = 10$ bar, $p_2 = 6$ bar and $\Delta p = 1$ bar.

2) With the LFR/LFRS-...-DI.

† 125 l/min must be available for the fully automatic condensate drain to close correctly.

Operating and environmental conditions		
Condensate drain	Manual	Fully automatic
Operating pressure [bar]	1 ... 16	2 ... 12
Operating medium	Compressed air to ISO 8573-1:2010 [--9:-]	Compressed air to ISO 8573-1:2010 [7:9:-]
	Inert gases	
Ambient temperature [°C]	-10 ... +60	+5 ... +60
Temperature of medium [°C]	-10 ... +60	+5 ... +60
Storage temperature [°C]	-10 ... +60	
Corrosion resistance class CRC ¹⁾	2	

1) More information www.festo.com/x/topic/crc.

Weight [g]				
Size	Mini	Midi	Maxi	
			Connection G1/2, G3/4	Connection G1
With pressure gauge				
LFR-...	460	920	1370	1470
LFR-...-DI	-	-	1670	1670
LFRS-...	560	1160	1470	1570
LFRS-...-DI	-	-	1950	1950
Without pressure gauge				
LFR-...	410	830	1300	1400
LFR-...-DI	-	-	1600	1600
LFRS-...	510	1070	1400	1500
LFRS-...-DI	-	-	1880	1880

Datasheet

Materials

Sectional view

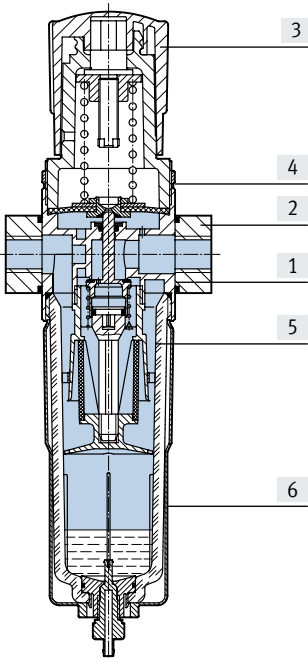

[1]	Housing	Die-cast zinc
[2]	Connecting plates	Die-cast zinc/aluminium
[3]	Regulating knob	PA
[4]	Knurled nut	Aluminium
[5]	Bowl	PC
[6]	Metal bowl guard	Aluminium
-	Seals	NBR
Note on materials		RoHS-compliant

Datasheet

Standard flow rate q_n as a function of output pressure p_2

LFR/LFRS-1/4-D-MINI

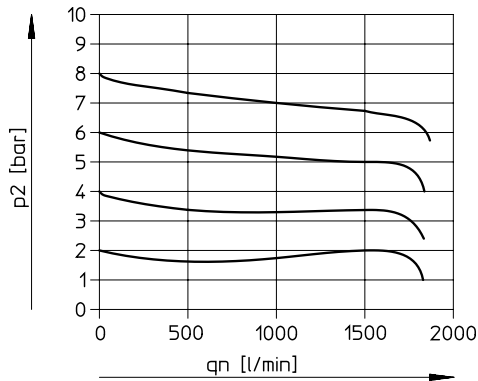

LFR/LFRS-1/2-D-MIDI

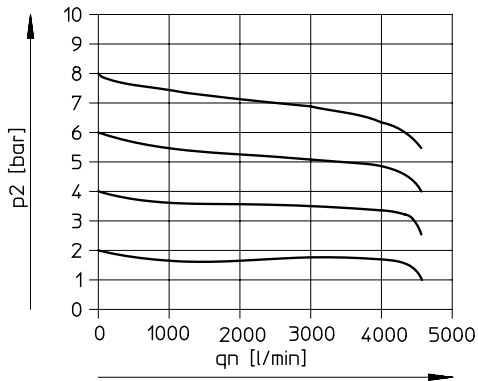

LFR/LFRS-1-D-MAXI

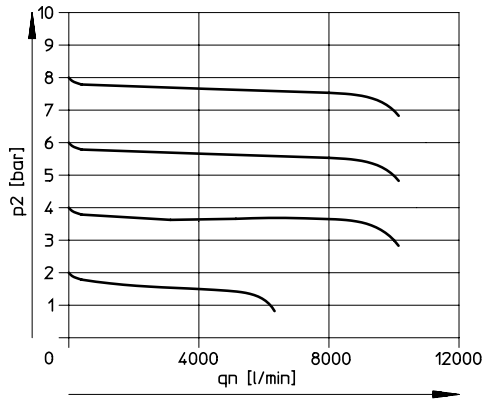

LFR/LFRS-1-D-DI-MAXI

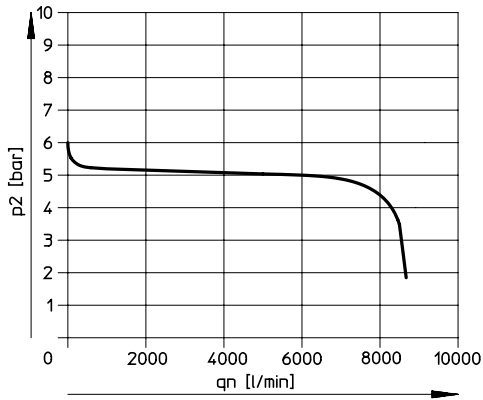

Primary pressure $p_1 = 10$ bar

Note
 In order to improve the control performance, internal air consumption depending on the input pressure is integrated into the design with the LFR/LFRS-...-MAXI.

Internal air consumption q_n as a function of input pressure p_1

LFR/LFRS-...-MAXI

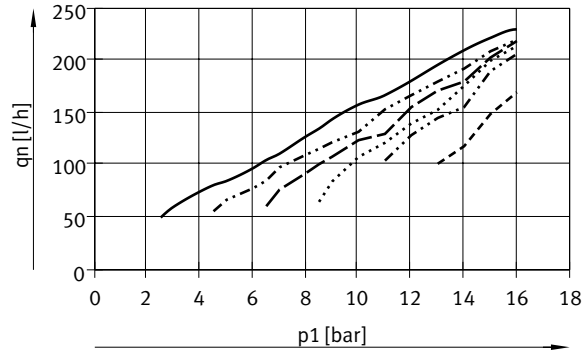

- $p_2 = 2$ bar
- · - · - $p_2 = 4$ bar
- - - $p_2 = 6$ bar
- · · · · $p_2 = 8$ bar
- · - · - $p_2 = 10$ bar
- - - $p_2 = 12$ bar

Datasheet

Dimensions

Download CAD data → www.festo.com

Mini/Midi/Maxi

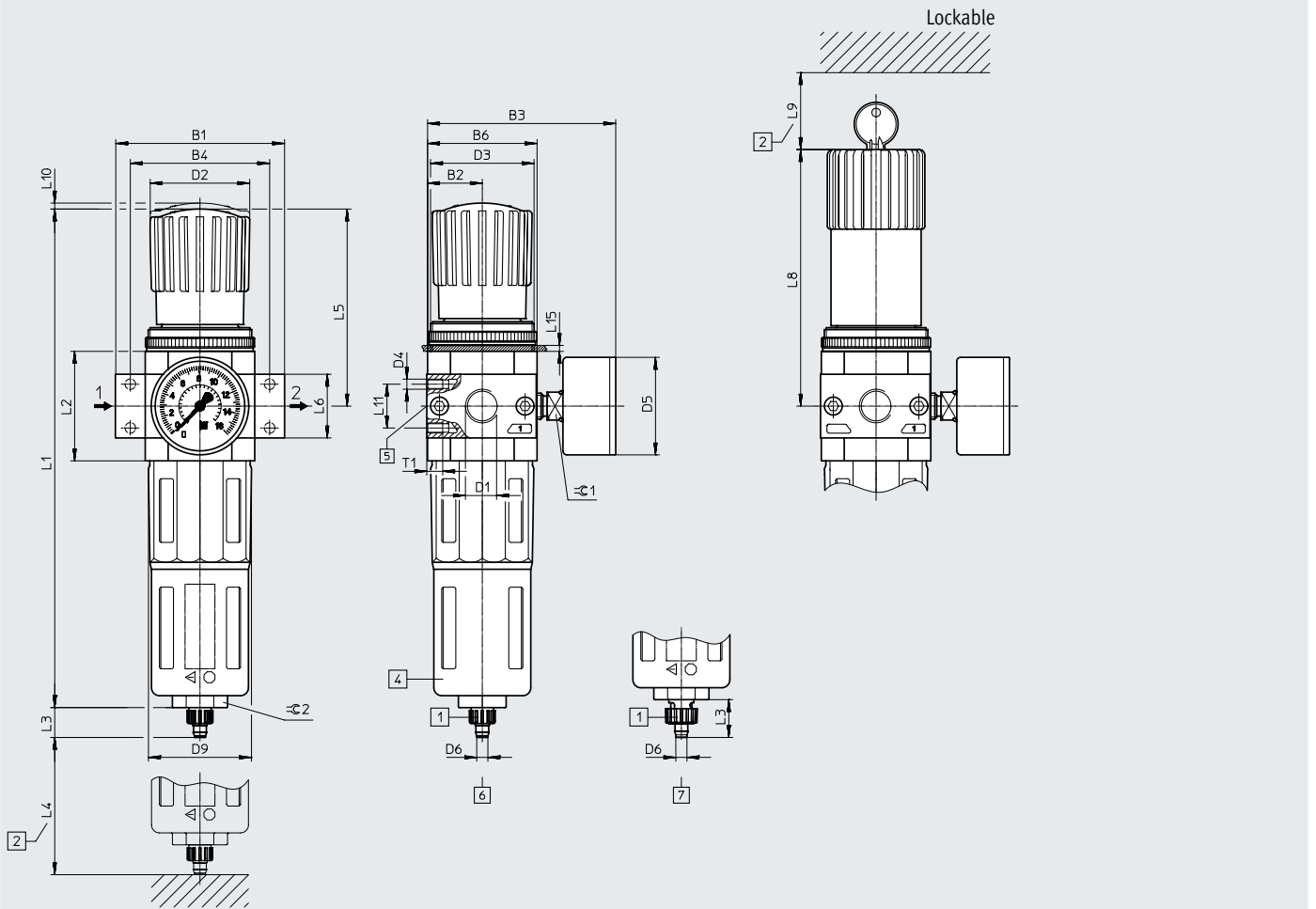

- [1] Barbed connector for plastic tubing PUN(-H)-8x1.25
 - [2] Installation dimension
 - [4] Metal bowl guard
 - [5] Second pressure gauge connection
 - [6] Manual condensate drain
 - [7] Fully automatic condensate drain
- Flow direction

Type	B1	B2	B3	B4	B6	D1	D2 ∅	D3	D4	D5 ∅	D6 ∅	D9 ∅
Mini												
LFR/LFRS-1/8-D-MINI (A)	64	20	76	~52	40	G1/8	31	M36x1.5	M4	39	5.6	38
LFR/LFRS-1/4-D-MINI (A)						G1/4						
LFR/LFRS-3/8-D-MINI (A)	70					G3/8						
Midi												
LFR/LFRS-1/4-D-MIDI (A)	~85	27.5	~94.5	~70	55	G1/4	50	M52x1.5	M5	39	5.6	52
LFR/LFRS-3/8-D-MIDI (A)						G3/8						
LFR/LFRS-1/2-D-MIDI (A)						G1/2						
LFR/LFRS-3/4-D-MIDI (A)						G3/4						
Maxi												
LFR/LFRS-1/2-D-MAXI (A)	96	33	106	80	66	G1/2	31	M36x1.5	M5	39	5.6	65
LFR/LFRS-1/2-D-DI-MAXI (A)			105				49	M52x1.5				
LFR/LFRS-3/4-D-MAXI (A)			106			49	31	M36x1.5				
LFR/LFRS-3/4-D-DI-MAXI (A)			105				49	M52x1.5				
LFR/LFRS-1-D-MAXI (A)	116		106	91		G1	31	M36x1.5				
LFR/LFRS-1-D-DI-MAXI (A)			105				49	M52x1.5				

† Note: This product corresponds to ISO 1179-1 and ISO 228-1.

Datasheet

Type	L1	L2	L3	L4 min.	L5	L6	L8	L9	L10	L11 ±0.2	L15 max.	T1 min.	≅ 1	≅ 2
Mini														
LFR/LFRS-1/8-D-MINI (A)	192.9	40	15 (19) ¹⁾	60	~69	20	98	60	3	11	3	7	14	22
LFR/LFRS-1/4-D-MINI (A)														
LFR/LFRS-3/8-D-MINI (A)														
Midi														
LFR/LFRS-1/4-D-MIDI (A)	250	55 ±0.1	15 (19) ¹⁾	80	99	32 ±0.3	130	60	3	22	5	8	14	24
LFR/LFRS-3/8-D-MIDI (A)														
LFR/LFRS-1/2-D-MIDI (A)														
LFR/LFRS-3/4-D-MIDI (A)														
Maxi														
LFR/LFRS-1/2-D-MAXI (A)	252	66	15 (19) ¹⁾	90	82	32	111	60	3	22	4	8	14	24
LFR/LFRS-1/2-D-DI-MAXI (A)	275				~105	32	135		4					
LFR/LFRS-3/4-D-MAXI (A)	252				82	32	111		3					
LFR/LFRS-3/4-D-DI-MAXI (A)	275				~105	36	135		4					
LFR/LFRS-1-D-MAXI (A)	252				82	40	111		3					
LFR/LFRS-1-D-DI-MAXI (A)	275				~105	41	135		4					

1) Value in brackets refers to the fully automatic condensate drain.

Datasheet

Ordering data

Pressure regulation range 0.5 ... 12 bar, rotary knob with latch, connecting plates with threaded connection

Condensate drain	Size	Connection	Grade of filtration 5 µm		Grade of filtration 40 µm	
			Part no.	Type	Part no.	Type

With pressure gauge, outer scale in bar, inner scale in psi

Manual	Mini	G1/8	162718	LFR-1/8-D-5M-MINI	159630	LFR-1/8-D-MINI	
		G1/4	162719	LFR-1/4-D-5M-MINI	159631	LFR-1/4-D-MINI	
		G3/8	162720	LFR-3/8-D-5M-MINI	162682	LFR-3/8-D-MINI	
	Midi	G1/4	186483	LFR-1/4-D-5M-MIDI	186481	LFR-1/4-D-MIDI	
		G3/8	162721	LFR-3/8-D-5M-MIDI	159582	LFR-3/8-D-MIDI	
		G1/2	162722	LFR-1/2-D-5M-MIDI	159584	LFR-1/2-D-MIDI	
		G3/4	162723	LFR-3/4-D-5M-MIDI	162683	LFR-3/4-D-MIDI	
	Maxi	G1/2	186491	LFR-1/2-D-5M-MAXI	186489	LFR-1/2-D-MAXI	
		G3/4	162724	LFR-3/4-D-5M-MAXI	159632	LFR-3/4-D-MAXI	
		G1	162725	LFR-1-D-5M-MAXI	159633	LFR-1-D-MAXI	
	Fully automatic	Mini	G1/8	162726	LFR-1/8-D-5M-MINI-A	159634	LFR-1/8-D-MINI-A
			G1/4	162727	LFR-1/4-D-5M-MINI-A	159635	LFR-1/4-D-MINI-A
G3/8			162728	LFR-3/8-D-5M-MINI-A	162684	LFR-3/8-D-MINI-A	
Midi		G1/4	186486	LFR-1/4-D-5M-MIDI-A	186484	LFR-1/4-D-MIDI-A	
		G3/8	162729	LFR-3/8-D-5M-MIDI-A	159583	LFR-3/8-D-MIDI-A	
		G1/2	162730	LFR-1/2-D-5M-MIDI-A	159585	LFR-1/2-D-MIDI-A	
		G3/4	162731	LFR-3/4-D-5M-MIDI-A	162685	LFR-3/4-D-MIDI-A	
Maxi		G1/2	186494	LFR-1/2-D-5M-MAXI-A	186492	LFR-1/2-D-MAXI-A	
		G3/4	162732	LFR-3/4-D-5M-MAXI-A	159636	LFR-3/4-D-MAXI-A	
		G1	162733	LFR-1-D-5M-MAXI-A	159637	LFR-1-D-MAXI-A	

Without pressure gauge

Manual	Mini	G1/8	192610	LFR-1/8-D-5M-O-MINI	162686	LFR-1/8-D-O-MINI	
		G1/4	192611	LFR-1/4-D-5M-O-MINI	162687	LFR-1/4-D-O-MINI	
		G3/8	192612	LFR-3/8-D-5M-O-MINI	162688	LFR-3/8-D-O-MINI	
	Midi	G1/4	192613	LFR-1/4-D-5M-O-MIDI	186482	LFR-1/4-D-O-MIDI	
		G3/8	192614	LFR-3/8-D-5M-O-MIDI	162689	LFR-3/8-D-O-MIDI	
		G1/2	192615	LFR-1/2-D-5M-O-MIDI	162690	LFR-1/2-D-O-MIDI	
		G3/4	192616	LFR-3/4-D-5M-O-MIDI	162691	LFR-3/4-D-O-MIDI	
	Maxi	G1/2	192617	LFR-1/2-D-5M-O-MAXI	186490	LFR-1/2-D-O-MAXI	
		G3/4	192618	LFR-3/4-D-5M-O-MAXI	162692	LFR-3/4-D-O-MAXI	
		G1	192619	LFR-1-D-5M-O-MAXI	162693	LFR-1-D-O-MAXI	
	Fully automatic	Mini	G1/8	192620	LFR-1/8-D-5M-O-MINI-A	162694	LFR-1/8-D-O-MINI-A
			G1/4	192621	LFR-1/4-D-5M-O-MINI-A	162695	LFR-1/4-D-O-MINI-A
G3/8			192622	LFR-3/8-D-5M-O-MINI-A	162696	LFR-3/8-D-O-MINI-A	
Midi		G1/4	192623	LFR-1/4-D-5M-O-MIDI-A	186485	LFR-1/4-D-O-MIDI-A	
		G3/8	192624	LFR-3/8-D-5M-O-MIDI-A	162697	LFR-3/8-D-O-MIDI-A	
		G1/2	192625	LFR-1/2-D-5M-O-MIDI-A	162698	LFR-1/2-D-O-MIDI-A	
		G3/4	192626	LFR-3/4-D-5M-O-MIDI-A	162699	LFR-3/4-D-O-MIDI-A	
Maxi		G1/2	192627	LFR-1/2-D-5M-O-MAXI-A	186493	LFR-1/2-D-O-MAXI-A	
		G3/4	192628	LFR-3/4-D-5M-O-MAXI-A	162700	LFR-3/4-D-O-MAXI-A	
		G1	192629	LFR-1-D-5M-O-MAXI-A	162701	LFR-1-D-O-MAXI-A	

Datasheet

Ordering data					
Pressure regulation range 0.5 ... 7 bar, rotary knob with latch, connecting plates with threaded connection					
Condensate drain	Size	Connection	Grade of filtration 40 µm		
			Part no.	Type	
With pressure gauge, outer scale in bar, inner scale in psi					
Manual	Mini	G1/8	162702	LFR-1/8-D-7-MINI	
		G1/4	162703	LFR-1/4-D-7-MINI	
		G3/8	162704	LFR-3/8-D-7-MINI	
	Midi	G1/4	186487	LFR-1/4-D-7-MIDI	
		G3/8	162705	LFR-3/8-D-7-MIDI	
		G1/2	162706	LFR-1/2-D-7-MIDI	
		G3/4	162707	LFR-3/4-D-7-MIDI	
	Maxi	G1/2	186495	LFR-1/2-D-7-MAXI	
		G3/4	162708	LFR-3/4-D-7-MAXI	
		G1	162709	LFR-1-D-7-MAXI	
Fully automatic	Mini	G1/8	162710	LFR-1/8-D-7-MINI-A	
		G1/4	162711	LFR-1/4-D-7-MINI-A	
		G3/8	162712	LFR-3/8-D-7-MINI-A	
	Midi	G1/4	186488	LFR-1/4-D-7-MIDI-A	
		G3/8	162713	LFR-3/8-D-7-MIDI-A	
		G1/2	162714	LFR-1/2-D-7-MIDI-A	
		G3/4	162715	LFR-3/4-D-7-MIDI-A	
	Maxi	G1/2	186496	LFR-1/2-D-7-MAXI-A	
		G3/4	162716	LFR-3/4-D-7-MAXI-A	
		G1	162717	LFR-1-D-7-MAXI-A	
	Without pressure gauge				
	Manual	Mini	G1/8	192590	LFR-1/8-D-7-O-MINI
G1/4			192591	LFR-1/4-D-7-O-MINI	
G3/8			192592	LFR-3/8-D-7-O-MINI	
Midi		G1/4	192593	LFR-1/4-D-7-O-MIDI	
		G3/8	192594	LFR-3/8-D-7-O-MIDI	
		G1/2	192595	LFR-1/2-D-7-O-MIDI	
		G3/4	192596	LFR-3/4-D-7-O-MIDI	
Maxi		G1/2	192597	LFR-1/2-D-7-O-MAXI	
		G3/4	192598	LFR-3/4-D-7-O-MAXI	
		G1	192599	LFR-1-D-7-O-MAXI	
Fully automatic	Mini	G1/8	192600	LFR-1/8-D-7-O-MINI-A	
		G1/4	192601	LFR-1/4-D-7-O-MINI-A	
		G3/8	192602	LFR-3/8-D-7-O-MINI-A	
	Midi	G1/4	192603	LFR-1/4-D-7-O-MIDI-A	
		G3/8	192604	LFR-3/8-D-7-O-MIDI-A	
		G1/2	192605	LFR-1/2-D-7-O-MIDI-A	
		G3/4	192606	LFR-3/4-D-7-O-MIDI-A	
	Maxi	G1/2	192607	LFR-1/2-D-7-O-MAXI-A	
		G3/4	192608	LFR-3/4-D-7-O-MAXI-A	
		G1	192609	LFR-1-D-7-O-MAXI-A	

Datasheet

Ordering data

Pressure regulation range 0.5 ... 12 bar, directly actuated diaphragm regulator with integrated return flow function, rotary knob with latch, connecting plates with threaded connection

Condensate drain	Size	Connection	Grade of filtration 5 µm		Grade of filtration 40 µm	
			Part no.	Type	Part no.	Type

With pressure gauge, outer scale in bar, inner scale in psi

Manual	Maxi	G1/2	192370	LFR-1/2-D-5M-DI-MAXI	192368	LFR-1/2-D-DI-MAXI
		G3/4	192376	LFR-3/4-D-5M-DI-MAXI	192374	LFR-3/4-D-DI-MAXI
		G1	192382	LFR-1-D-5M-DI-MAXI	192380	LFR-1-D-DI-MAXI
Fully automatic	Maxi	G1/2	192388	LFR-1/2-D-5M-DI-MAXI-A	192386	LFR-1/2-D-DI-MAXI-A
		G3/4	192394	LFR-3/4-D-5M-DI-MAXI-A	192392	LFR-3/4-D-DI-MAXI-A
		G1	192400	LFR-1-D-5M-DI-MAXI-A	192398	LFR-1-D-DI-MAXI-A

Without pressure gauge

Manual	Maxi	G1/2	192371	LFR-1/2-D-5M-O-DI-MAXI	192369	LFR-1/2-D-O-DI-MAXI
		G3/4	192377	LFR-3/4-D-5M-O-DI-MAXI	192375	LFR-3/4-D-O-DI-MAXI
		G1	192383	LFR-1-D-5M-O-DI-MAXI	192381	LFR-1-D-O-DI-MAXI
Fully automatic	Maxi	G1/2	192389	LFR-1/2-D-5M-O-DI-MAXI-A	192387	LFR-1/2-D-O-DI-MAXI-A
		G3/4	192395	LFR-3/4-D-5M-O-DI-MAXI-A	192393	LFR-3/4-D-O-DI-MAXI-A
		G1	192401	LFR-1-D-5M-O-DI-MAXI-A	192399	LFR-1-D-O-DI-MAXI-A

Ordering data

Pressure regulation range 0.5 ... 7 bar, directly actuated diaphragm regulator with integrated return flow function, rotary knob with latch, connecting plates with threaded connection

Condensate drain	Size	Connection	Grade of filtration 5 µm		Grade of filtration 40 µm	
			Part no.	Type	Part no.	Type

With pressure gauge, outer scale in bar, inner scale in psi

Manual	Maxi	G1/2	-		192372	LFR-1/2-D-7-DI-MAXI
		G3/4	-		192378	LFR-3/4-D-7-DI-MAXI
		G1	-		192384	LFR-1-D-7-DI-MAXI
Fully automatic	Maxi	G1/2	-		192390	LFR-1/2-D-7-DI-MAXI-A
		G3/4	-		192396	LFR-3/4-D-7-DI-MAXI-A
		G1	-		192402	LFR-1-D-7-DI-MAXI-A

Without pressure gauge

Manual	Maxi	G1/2	-		192373	LFR-1/2-D-7-O-DI-MAXI
		G3/4	-		192379	LFR-3/4-D-7-O-DI-MAXI
		G1	-		192385	LFR-1-D-7-O-DI-MAXI
Fully automatic	Maxi	G1/2	-		192391	LFR-1/2-D-7-O-DI-MAXI-A
		G3/4	-		192397	LFR-3/4-D-7-O-DI-MAXI-A

Ordering data

Pressure regulation range 0.5 ... 12 bar, rotary knob with integrated lock, connecting plates with threaded connection

Condensate drain	Size	Connection	Grade of filtration 5 µm		Grade of filtration 40 µm	
			Part no.	Type	Part no.	Type

With pressure gauge, outer scale in bar, inner scale in psi

Manual	Mini	G1/4	194716	LFRS-1/4-D-5M-MINI	194708	LFRS-1/4-D-MINI
	Midi	G1/2	194764	LFRS-1/2-D-5M-MIDI	194756	LFRS-1/2-D-MIDI
Fully automatic	Mini	G1/4	194718	LFRS-1/4-D-5M-MINI-A	194709	LFRS-1/4-D-MINI-A
	Midi	G1/2	194766	LFRS-1/2-D-5M-MIDI-A	194757	LFRS-1/2-D-MIDI-A

Ordering data

Pressure regulation range 0.5 ... 7 bar, rotary knob with integrated lock, connecting plates with threaded connection



Condensate drain	Size	Connection	Grade of filtration 5 µm		Grade of filtration 40 µm	
			Part no.	Type	Part no.	Type

With pressure gauge, outer scale in bar, inner scale in psi

Manual	Mini	G1/4	-		194712	LFRS-1/4-D-7-MINI
	Midi	G1/2	-		194760	LFRS-1/2-D-7-MIDI
Fully automatic	Mini	G1/4	-		194714	LFRS-1/4-D-7-MINI-A
	Midi	G1/2	-		194762	LFRS-1/2-D-7-MIDI-A

Datasheet

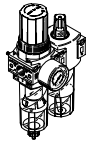
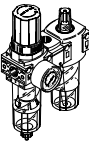
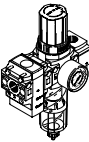
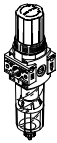
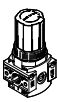
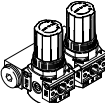
Product range overview – Service unit components, D series, polymer

Type	Size	Pneumatic connection		Pressure regulation range [bar]	Grade of filtration [µm]		
		G1/4	G1/2		5	40	
Service units							
FRC		Mini	■	-	■	■	■
Service unit combinations							
FRC-K		Mini	■	-	■	-	■
LFR-K		Mini	■	-	■	-	■
Individual devices							
Filter regulators LFR		Mini	■	-	■	■	■
Pressure regulators LR		Mini	■	-	■	-	-
Pressure regulator manifolds LRB-K		Mini	-	■	■	-	-
On/off valves HE		Mini	■	-	-	-	-

Product range overview – Service unit components, D series, polymer

Type	Size	Condensate drain		Pressure indication		Actuator lock	Regulating functions		→ Page/ Internet
		Manual	Semi-automatic	With pressure gauge	Without pressure gauge		With secondary exhausting	With return flow function	
Service units									
FRC	Mini	■	■	■	-	■	■	■	frc
Service unit combinations									
FRC-K	Mini	■	-	■	-	■	■	■	frc
LFR-K	Mini	■	-	■	-	■	■	■	lfr
Individual devices									
Filter regulators LFR	Mini	■	■	■	■	■	■	■	lfr
Pressure regulators LR	Mini	-	-	■	■	■	■	■	lr
Pressure regulator manifolds LRB-K	Mini	-	-	-	■	■	■	■	lrb
On/off valves HE	Mini	-	-	-	■	-	-	-	he

Peripherals overview

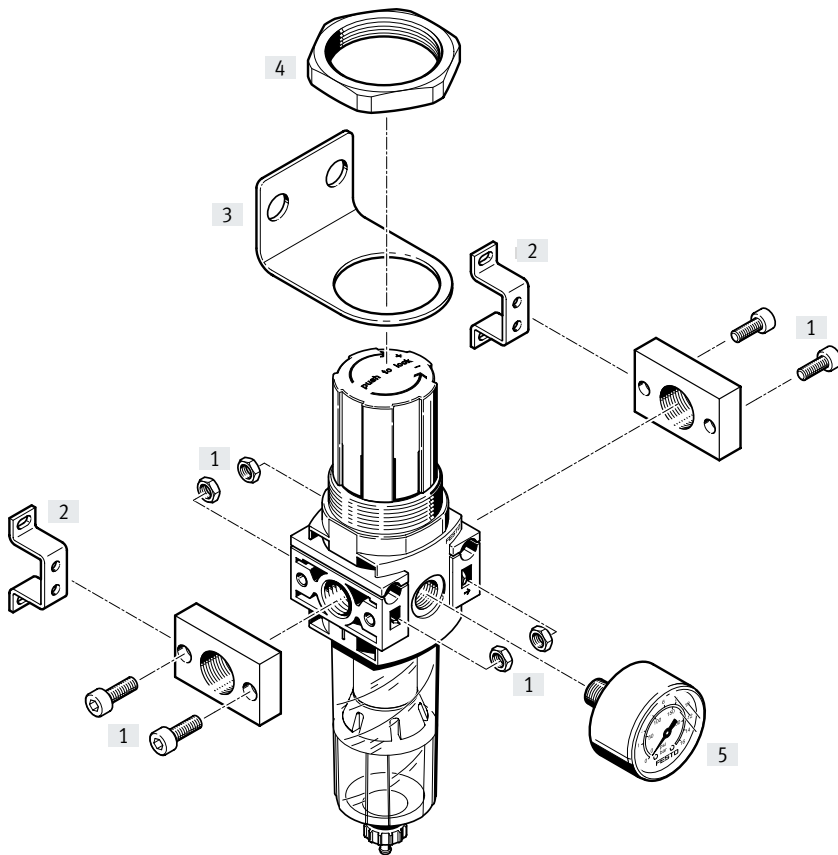

Mounting attachments and accessories

		→ Page/Internet
[1]	Connection kit PBL	pbl
[2]	Mounting bracket HFOE	hfoe-d
[3]	Mounting bracket HR-D	hr-d
[4]	Hex nut HMR	hmr-d
[5]	Pressure gauge MA	26

Type codes

001	Series
LFR	Filter regulator
002	Pneumatic connection
1/4	Female thread G1/4
003	Version
DB	D series, polymer
004	Pressure regulation range
7	0.5 ... 7 bar (0.05 ... 0.7 MPa)

005	Grade of filtration
	40 µm
5M	5 µm
006	Pressure gauge
	With pressure gauge
O	Without pressure gauge
007	Size
MINI	Grid dimension 40 mm (without connecting plates)
008	Condensate drain
	Manually rotating
H	Semi-automatic

Datasheet

Condensate drain, manual, with pressure gauge

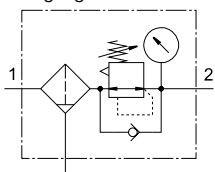

Condensate drain, manual, without pressure gauge

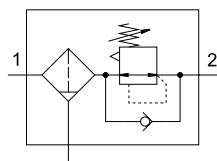

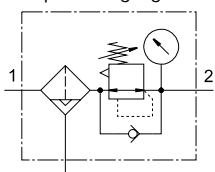

Condensate drain, semi-automatic, with pressure gauge

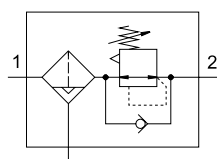

Condensate drain, semi-automatic, without pressure gauge



-  Flow rate
500 ... 1200 l/min
-  Temperature range
-5 ... +50 °C
-  Operating pressure
1.5 ... 10 bar

- Space-saving design with filter and regulator in a single unit
- Good particle separation and high flow rate
- Good regulation characteristics with minimal hysteresis
- Choice of manual or semi-automatic condensate drain
- Setting values are secured by locking the rotary knob
- Choice of 5 µm or 40 µm filter inserts
- New filter cartridges → page 25

General technical data		Mini	
Size		With pressure gauge	Without pressure gauge
Pneumatic port 1, 2		G1/4	
Design		Filter regulator with pressure gauge	Filter regulator without pressure gauge
Regulator function		With return flow function, with secondary exhaust	
Type of mounting		In-line installation Via through-hole With mounting bracket	
Mounting position		Vertical ±5°	
Grade of filtration	[µm]	5 40	
Air purity class at the output		Compressed air to ISO 8573-1:2010 [6:8:4] (grade of filtration 5 µm) Compressed air to ISO 8573-1:2010 [7:8:4] (grade of filtration 40 µm) Inert gases	
Condensate drain		Manual Semi-automatic	
Actuator lock		Rotary knob with latch	
Pressure regulation range	[bar]	0.5 ... 7	
Max. pressure hysteresis	[bar]	0.5	
Pressure indication		With pressure gauge	Prepared for G1/8
Pressure gauge connection		G1/8	

Standard nominal flow rate ¹⁾ qnN [l/min]		
Size		Mini
Grade of filtration	5 µm	≥ 1000
	40 µm	≥ 1200

1) Measured at p1 = 10 bar, p2 = 6 bar and Δp = 1 bar.

† 125 l/min must be available for the semi-automatic condensate drain to close correctly.

Datasheet

Operating and environmental conditions

Size	Mini
Operating pressure [bar]	1.5 ... 10
Operating medium	Compressed air to ISO 8573-1:2010 [-:9:-] Inert gases
Ambient temperature [°C]	-5 ... +50
Temperature of medium [°C]	-5 ... +50
Corrosion resistance class CRC ¹⁾	1

1) More information www.festo.com/x/topic/crc.

Weight [g]

Size	Mini
Filter regulator	200

Materials

Sectional view

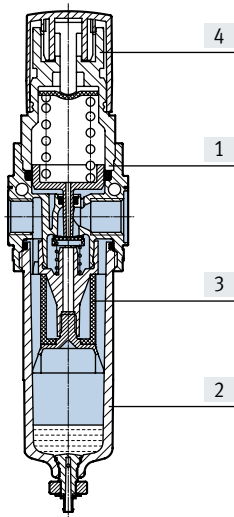

Filter regulator	Mini
[1] Housing	Reinforced PA
[2] Bowl	PC
[3] Filter	PE
[4] Rotary knob	POM
- Seals	NBR
Note on materials	RoHS-compliant

Standard flow rate q_n as a function of output pressure p_2

Operating pressure $p_1 = 10$ bar

Grade of filtration 5 μm

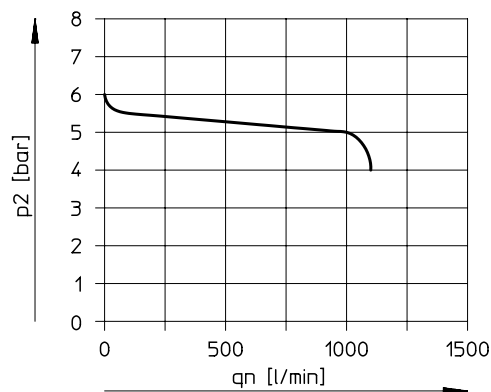

Grade of filtration 40 μm

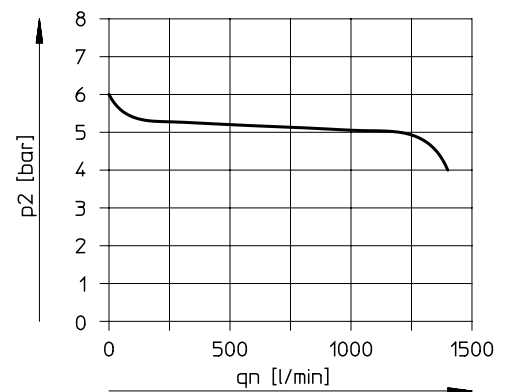

Note

Minor leakage at the output is intended by design. It improves the control behaviour of the regulator which is not compensated for input pressure.

In rare cases, however, the leakage can be up to 500 l/h.

Datasheet

Dimensions

Download CAD data → www.festo.com

Mini

With pressure gauge

[1] Barbed connector for plastic tubing PUN(-H)-8x1.25
 [2] Installation dimension
 [3] Socket head screw for wall mounting (2 included in the scope of delivery)
 [4] Manual condensate drain
 [5] Semi-automatic condensate drain

→ Flow direction

	B1	B2	B4	B6	B7 max.	B8	D1	D2 ∅	D3	D5 ∅	D6 ∅	D8
LFR-1/4-DB	44	20.5	34	41	37	9	G1/4	32	M36x1.5	39	5.6	M4

	L1	L2	L3	L4 min.	L5	L10	L12	L13	L14	⊕ 1
LFR-1/4-DB	171.7	47	17.3	60	76	2	20	10	9	14

Ordering data

Pressure regulation range 0.5 ... 7 bar

Condensate drain	Size	Connection	Grade of filtration 5 µm		Grade of filtration 40 µm	
			Part no.	Type	Part no.	Type

With pressure gauge, outer scale in bar, inner scale in psi

Manual	Mini	G1/4	539689	LFR-1/4-DB-7-5M-MINI	539685	LFR-1/4-DB-7-MINI
Semi-automatic	Mini	G1/4	539690	LFR-1/4-DB-7-5M-MINI-H	539686	LFR-1/4-DB-7-MINI-H

Without pressure gauge

Manual	Mini	G1/4	537644	LFR-1/4-DB-7-5M-O-MINI	537647	LFR-1/4-DB-7-O-MINI
Semi-automatic	Mini	G1/4	537646	LFR-1/4-DB-7-5M-O-MINI-H	537645	LFR-1/4-DB-7-O-MINI-H

Accessories

Filter cartridges, D series, metal



Ordering data

Size	Grade of filtration [μm]	Part no.	Type
Mini	5 (colour: blue)	159640	LFP-D-MINI-5M
	40 (colour: white)	363665	LFP-D-MINI-40M
Midi	5 (colour: blue)	159594	LFP-D-MIDI-5M
	40 (colour: white)	363667	LFP-D-MIDI-40M
Maxi	5 (colour: blue)	159641	LFP-D-MAXI-5M
	40 (colour: white)	363664	LFP-D-MAXI-40M

Filter cartridges, D series, polymer

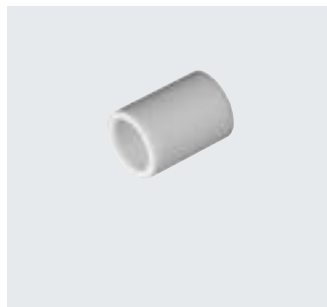

Ordering data

Size	Grade of filtration [μm]	Part no.	Type
Mini	5	547957	LFP-DB-MINI-5M
	40	534502	MS4-LFP-E

Accessories

Ordering data – Pressure gauge MA						
	Nominal size	Pneumatic connection	Display range		Part no.	Type
			[bar]	[psi]		
	Pressure gauge MA Datasheets → Internet: ma					
	40	G1/8	0 ... 10	0 ... 145	359874	MA-40-10-1/8
			0 ... 16	0 ... 232	345395	MA-40-16-1/8
	50	G1/4	0 ... 10	0 ... 145	359873	MA-50-10-1/4
			0 ... 16	0 ... 232	356759	MA-50-16-1/4
	Pressure gauge MA, DIN EN 837-1 Datasheets → Internet: ma					
	40	R1/8	0 ... 10	0 ... 145	162835	MA-40-10-1/8-EN
		G1/4	0 ... 10	0 ... 145	183900	MA-40-10-G1/4-EN
	Flanged pressure gauge FMA, DIN EN 837-1 Datasheets → Internet: fma					
	40	G1/4	0 ... 10	0 ... 145	159596	FMA-40-10-1/4-EN
0 ... 16			0 ... 232	159597	FMA-40-16-1/4-EN	
50	G1/4	0 ... 10	0 ... 145	159599	FMA-50-10-1/4-EN	
		0 ... 16	0 ... 232	159600	FMA-50-16-1/4-EN	

Ordering data – Pressure sensors SPAU Datasheets → Internet: spau						
	Pneumatic connection	Switching output	Display type	Electrical connection	Part no.	Type
Pressure sensor SPAU for direct mounting on the service unit component with pressure gauge connection (adapter for pneumatic connection included in the scope of delivery), pressure measurement range 0 ... 10 bar, relative pressure measurement						
	Male thread R1/8	2x PNP or 2x NPN, switchable	Illuminated LCD	M8x1, 4-pin	8001203	SPAU-P10R-T-R18M-L-PNLK-PNVBA-M8D
				M12x1, 4-pin	8001206	SPAU-P10R-T-R18M-L-PNLK-PNVBA-M12D
	Male thread R1/4			M8x1, 4-pin	8001209	SPAU-P10R-T-R14M-L-PNLK-PNVBA-M8D
				M12x1, 4-pin	8001208	SPAU-P10R-T-R14M-L-PNLK-PNVBA-M12D