

Parallel grippers HGPII, precise and positionable



Parallel grippers HGPPI, precise and positionable

Key features

General information

The parallel gripper HGPPI is a servopneumatic proportional gripper. It permits free and independent positioning of the gripper jaws, force/displacement regulation as well as speed regulation and metering of the gripping force.



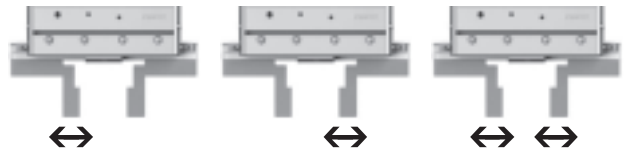



The parallel gripper enables flexible equipping tasks involving different workpiece sizes and shapes. It is smaller, lighter and yet more powerful than electrical grippers.

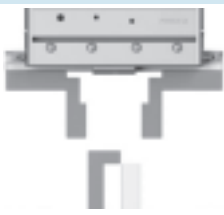

 **Note**

Sizing software
Gripper selection
→ www.festo.com

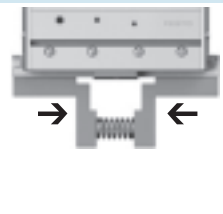
Typical applications

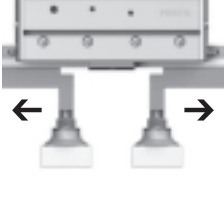
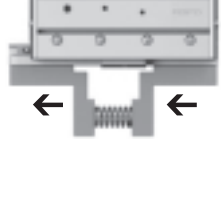
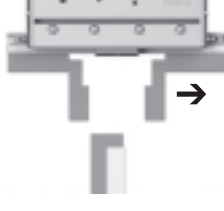
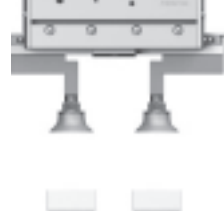
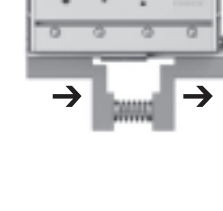
	Assembly of workpieces	Distribution of workpieces	Gripping with defined force
Step 1			
Step 2			
Step 3			
Step 4			

Parallel grippers HGPPI, precise and positionable

Key features

Pneumatic connections

From above

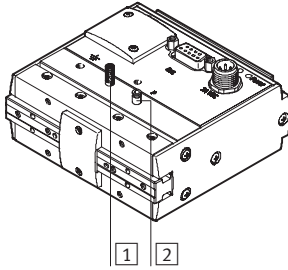

- 1 Pneumatic connection: Exhaust air
- 2 Pneumatic connection: Supply air

Mounting options

Direct mounting

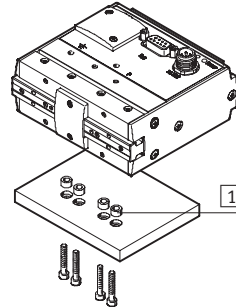

- 1 Centring sleeves ZBH-7
- 2 Connecting kit HAVB-3, HAVB-7

Dovetail mounting

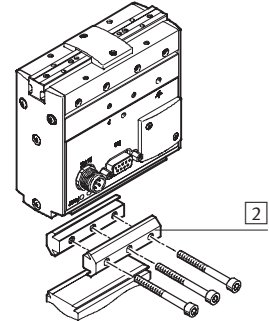

Electrical connections

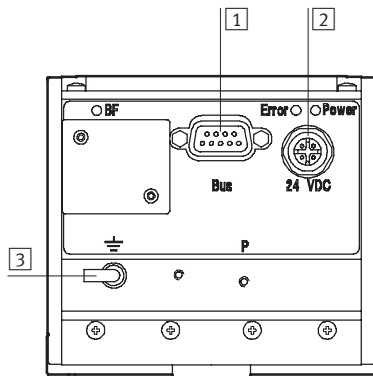

- 1 Fieldbus interface
- 2 Power supply
- 3 Earth terminal

On-site diagnosis

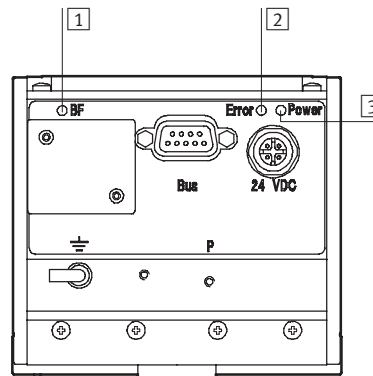

- 1 BF LED (red)
- 2 Error LED (red)
- 3 Power LED (green)

Note
Parallel grippers are not designed for the following applications:

- Machining
- Aggressive media

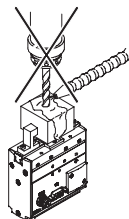

- Magnetic field

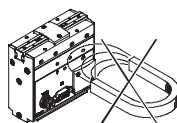

- Grinding dust



- Welding spatter

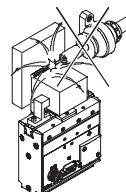

Parallel grippers HGPPI, precise and positionable

Peripherals overview and type codes

Peripherals overview

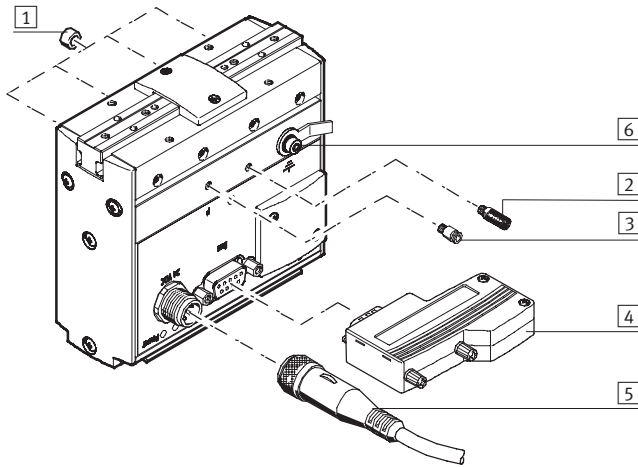

Accessories			
Type	Brief description		→ Page/Internet
1	Centring sleeve ZBH-7	For centring when mounting	10
2	Silencer U-M3	For damping the noise level	u
3	Push-in fitting QSM-M3-4	For connecting compressed air tubing with standard external diameters	quick star
4	Plug FBS-...	Profibus connector with 9-pin Sub-D plug	10
5	Cable with socket SIM-M12-...	For connecting the voltage supply	10
6	Earth terminal	Included in the scope of delivery of the gripper	-
7	-	Drive/gripper combinations	adapter kit

Type codes

		HGPPI	-	12	-	10	-	PB
Type								
HGPPI	Parallel gripper							
Size								
Stroke								
Interface								
PB	Profibus DP							

Parallel grippers HGPPI, precise and positionable

Technical data

FESTO

Function

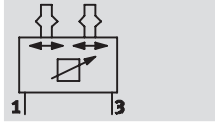

-  - Size
12
-  - Total stroke
20 mm



General technical data		
Size		12
Mechanical data		
Design		Twin pistons Ball bearing cage guide With integrated directly actuated poppet valves With integrated sequence controller With integrated displacement encoder With integrated pressure sensors With integrated closed-loop control
Mode of operation		Double-acting
Gripper function		Parallel
Number of gripper jaws		2
Variable stroke range per gripper jaw	[mm]	0 ... 10
Pneumatic connection		M3
Repetition accuracy	[mm]	± 0.1
Max. interchangeability	[mm]	≤ 0.2
Max. gripper jaw backlash	[mm]	0
Max. gripper jaw angular play	[°]	0
Position sensing		With hall sensor
Typical positioning time	[ms]	150 ... 250
Type of mounting		Via female thread and centring sleeve With dovetail-groove
Assembly position		Any
Minimum positioning stroke	[mm]	0.2
Min. positioning speed	[mm/s]	1
Weight	[g]	650
Electrical data		
Nominal voltage, load supply	[V DC]	24 ± 10%
Nominal voltage, logic supply	[V DC]	24 ± 10%
Residual ripple		5%
Max. current consumption, load	[A]	0.07
Max. current consumption, logic	[A]	0.2
Electrical connection		Plug, M12x1, 4-pin
Fieldbus		
Fieldbus coupling		Profibus DP
Version		RS 485 with electrical isolation
Addressing range		0 ... 125 with DIL switches
Electrical connection		Sub-D socket, 9-pin

Parallel grippers HGPPI, precise and positionable

Technical data

Operating and environmental conditions		
Operating pressure	[bar]	5 ... 6
Operating medium		Filtered compressed air, lubricated or unlubricated
Ambient temperature	[°C]	+5 ... +40
Relative air humidity		0 ... 95%, non-condensing
Corrosion resistance class CRC ¹⁾		2
Protection class		IP40
CE symbol (declaration of conformity)		In accordance with EU EMC directive

1) Corrosion resistance class 2 as per Festo standard 940 070
 Components requiring moderate corrosion resistance. Externally visible parts with primarily decorative surface requirements which are in direct contact with a normal industrial environment or media such as coolants or lubricating agents

Materials

Sectional view

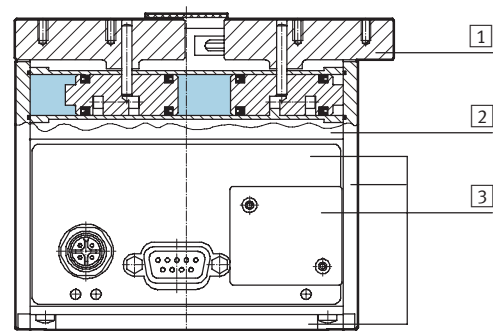

Parallel gripper		
1	Gripper jaws	High-strength wrought aluminium alloy, smooth-anodised
2	Housing	Smooth anodised aluminium
3	Cover plates	Wrought aluminium alloy, anodised

Gripping force [N] at 6 bar

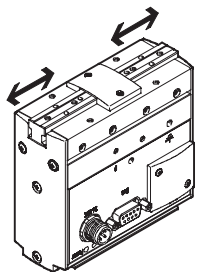

Size	12
Variable gripping force per gripper jaw	
Opening	10 ... 60
Closing	10 ... 60
Controllable total gripping force	
Opening	20 ... 120
Closing	20 ... 120
Maximum deviation from the desired gripping force	
Per gripper jaw	< 6

Parallel grippers HGPPI, precise and positionable

Technical data

FESTO

Characteristic load values at the gripper jaws

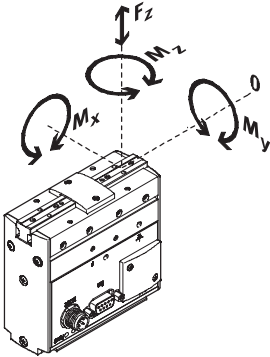

The indicated permissible forces and torques refer to a single gripper jaw. They include the lever arm, additional applied loads caused by the work-piece or external gripper fingers, as

well as forces which occur during movement.

The zero coordinate line (gripper finger guide) must be taken into consideration for the calculation of torques.

Size		12
Max. permissible force F_z	[N]	70
Max. permissible torque M_x	[Nm]	3
Max. permissible torque M_y	[Nm]	3
Max. permissible torque M_z	[Nm]	3

Mass moment of inertia [kgcm²]

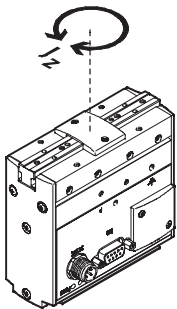

Inherent mass moment of inertia of the parallel gripper: 7.8 kgcm², specific to the central axis, without external gripper fingers, without load.

Maximum permissible lever arm x and eccentricity y

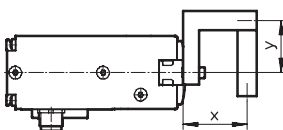

When gripping eccentrically, it is important to ensure that the following condition is observed with regard to the maximum gripping point:

$$\sqrt{(\text{Lever arm } x)^2 + (\text{Eccentricity } y)^2} < 70 \text{ mm}$$

Calculation example

Given:

Lever arm $x = 35 \text{ mm}$

Eccentricity $y = 45 \text{ mm}$

$$\sqrt{(35 \text{ mm})^2 + (45 \text{ mm})^2} = 57 \text{ mm}$$

$$57 \text{ mm} < 70 \text{ mm}$$

Result:

The calculated value is less than 70 mm. Thus the 35 mm lever arm is permitted in conjunction with the 45 mm eccentricity.

Parallel grippers HGPP1, precise and positionable

Technical data

Pin allocation

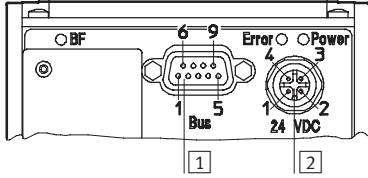

1 Profibus interface, 9-pin SUB-D socket	
Pin	Function
1	Earth
2	-
3	RxD/TxD-P
4	CNTR-P
5	DGND
6	VP
7	-
8	RxD/TxD-N
9	-

2 Voltage supply, 4-pin, M12x1 plug	
Pin	Function
1	24 V (logic)
2	24 V (load)
3	0 V (Logik)
4	Screen ¹⁾

1) Connection to housing via a 1 MOhm resistor

Dimensions

Download CAD data → www.festo.com

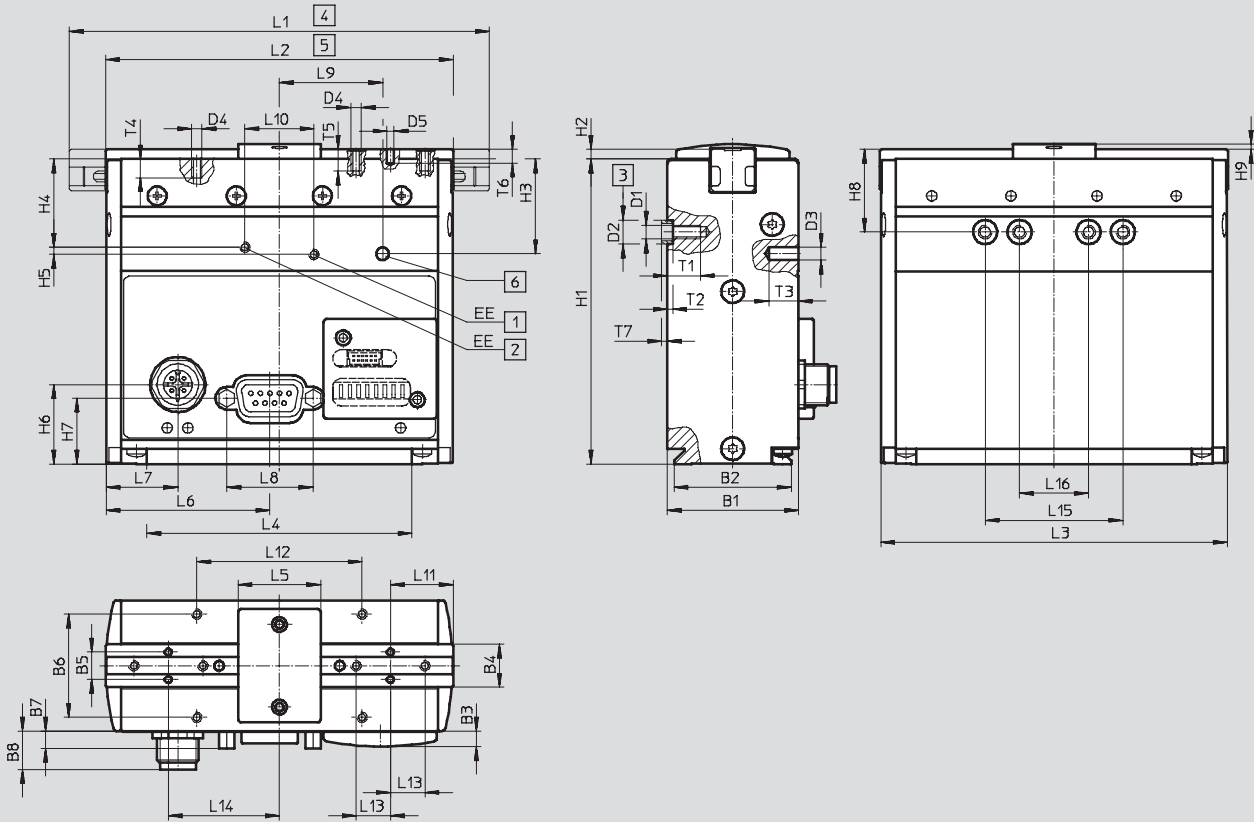

- 1 Pneumatic connection: Supply air (QSM-M3-4)
- 2 Pneumatic connection: Exhaust air (QSM-M3-4 or U-M3)
- 3 Hole for side-mounting with centring ring and non-ferromagnetic screws.
- 4 Gripper jaw open
- 5 Gripper jaw closed
- 6 Earth terminal (kit with M4x8 screw and cable lug enclosed)

Parallel grippers HGPPI, precise and positionable

FESTO

Technical data

Size	B1	B2 ±0.1	B3	B4 ±0.1	B5 ±0.02	B6 ±0.1	B7	B8	D1	D2 ∅ H7	D3 ∅	D4	D5 ∅ H8
12	38	34	4.5	12.5	8	30	5	11.1	M4	7	3.7	M3	6

Size	EE	H1 +0.1/-0.9	H2 ±0.15	H3	H4	H5	H6	H7	H8 +0.1/-0.5	H9 ±0.2
12	M3	88.6		27.5	25.6	2.1	23.1	19.2	24	3

Size	L1 +0.4/-0.1	L2 +0.4/-0.6	L3	L4	L5	L6	L7	L8	L9	L10	L11 ±0.02
12	122	101	100.6	77	24	47.5	20.8	25	30	20	18.25

Size	L12 ±0.1	L13 ±0.1	L14 +0.2/-0.3	L15 ¹⁾	L16 ¹⁾	T1	T2 +0.1	T3	T4	T5	T6	T7 -0.2
12	48	10	32.25	40	20	9.6	1.6	8.5	5.5	6.3	4	1.6

1) Tolerance for centring hole: ±0.02 mm
Tolerance for thread: ±0.1 mm

Parallel grippers HGPPi, precise and positionable

Technical data and accessories

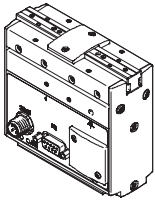

Piston	
	Part No. Type
	539 054 HGPPi-12-10-PB

Ordering data – Accessories					
	For size [mm]	Remarks	Part No.	Type	PU ¹⁾
Centring sleeve ZBH Technical data → Internet: zbh					
	12	For centring the gripper when mounting	186 717	ZBH-7	10

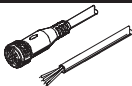
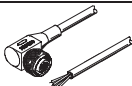
1) Packaging unit quantity

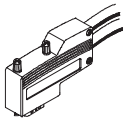
Ordering data – Connecting cables					Technical data → Internet: nebu
	Electrical connection, left	Electrical connection, right	Cable length [m]	Part No.	Type
	Straight socket, M12x1, 5-pin	Cable, open end, 4-pin	2.5	550 326	NEBU-M12G5-K-2.5-LE4
			5	541 328	NEBU-M12G5-K-5-LE4
	Angled socket, M12x1, 5-pin	Cable, open end, 4-pin	2.5	550 325	NEBU-M12G5-K-2.5-LE4
			5	541 329	NEBU-M12W5-K-5-LE4

Ordering data – Plug			
	Brief description	Part No.	Type
	Profibus connector with 9-pin Sub-D plug	533 780	FBS-SUB-9-WS-PB-K

Ordering data – Documentation				
	Brief description	Language	Part No.	Type
Description				
	User documentation in paper form is not included in the scope of delivery.	DE	543 299	P.BE-HGPPi-PB-DE
		EN	543 300	P.BE-HGPPi-PB-EN
		ES	543 301	P.BE-HGPPi-PB-ES
		FR	543 302	P.BE-HGPPi-PB-FR
		IT	543 303	P.BE-HGPPi-PB-IT
		SV	543 304	P.BE-HGPPi-PB-SV
Documentation package				
	User documentation on CD-ROM is included in the scope of delivery for the parallel gripper HGPPi.	DE, EN, ES, FR, IT, SV	549 199	P.BE-HGPPi-PB-UDOK