

Cantilever axes EGSA, with spindle drive



- 1 - Type discontinued  
Available up until 2013

## Cantilever axes EGSA, with spindle drive

Key features

### At a glance

The spindle driven cantilever axis EGSA reduces cycle times to an absolute minimum. This is thanks to a powerful mechanical system and a range of motor choices adapted to the requirements of the application.

In contrast to the electric cantilever axis DGEA designed for longer strokes, the EGSA demonstrates its strengths with short strokes.

Advantages:

- Maximum precision
- High dynamic response
- Repetition accuracy of  $\pm 0.01$  mm

### Complete system comprises cantilever axis, motor, motor controller and motor mounting kit

#### Spindle driven cantilever axis

With axial kit



With parallel kit

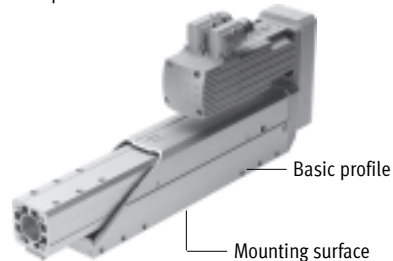

Note

The spindle driven cantilever axis must only be mounted using the underside of the base profile (→ picture on left). The lateral holes on the base profile are provided for securing accessories (e.g. protective trunking).

#### Motor

→ 11



1



2

- 1 Servo motor EMMS-AS
- 2 Stepper motor EMMS-ST

Note

A range of specially adapted complete solutions is available for the spindle driven cantilever axis EGSA and the motors.

#### Motor controller

Technical data → Internet: motor controller



1



2

- 1 Servo motor controller CMMP-AS
- 2 Stepper motor controller CMMS-ST

#### Motor mounting kit

→ 11

Axial kit



Parallel kit

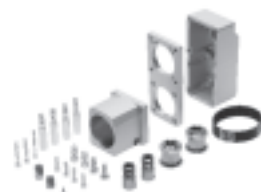

There are complete kits for both parallel and axial motor mounting.

## Cantilever axes EGSA, with spindle drive

Key features

System product for handling and assembly technology

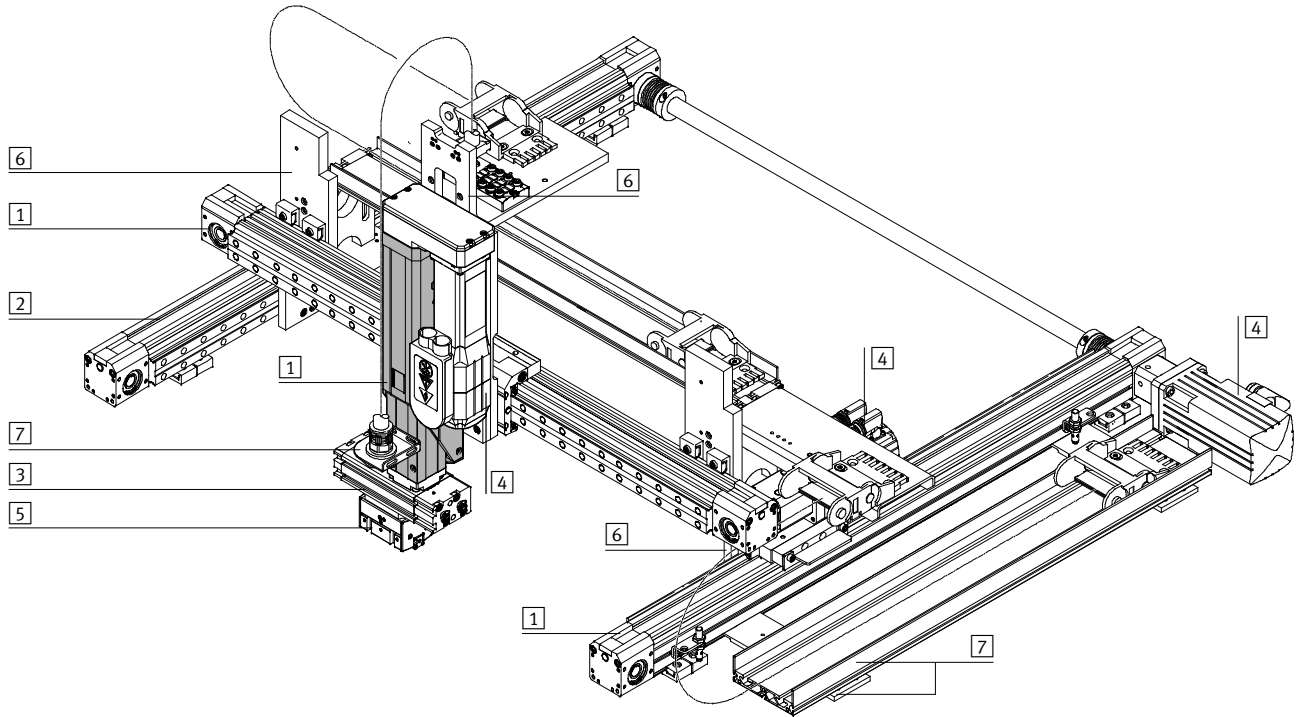

System components and accessories		
	Brief description	→ Page/Internet
1	Axes	Wide range of combinations possible within handling and assembly technology axes
2	Guide axes	To increase force and torque capacity in multi-axis applications guide axes
3	Drives	Wide range of combinations possible within handling and assembly technology drive
4	Motors	Servo and stepper motors motor
5	Grippers	Wide range of variations possible within handling and assembly technology gripper
6	Adapters	For drive/drive and drive/gripper connections adapter kit
7	Installation components	For a clean, safe layout of electrical cables and tubing installation component

- 7 - Type discontinued  
Available up until 2013

## Cantilever axes EGSA, with spindle drive

Type codes and peripherals overview

FESTO

### Type codes

EGSA		50	100
<b>Type</b>			
EGSA	Cantilever axis with spindle drive		
<b>Size</b>			
<b>Stroke [mm]</b>			

### Peripherals overview

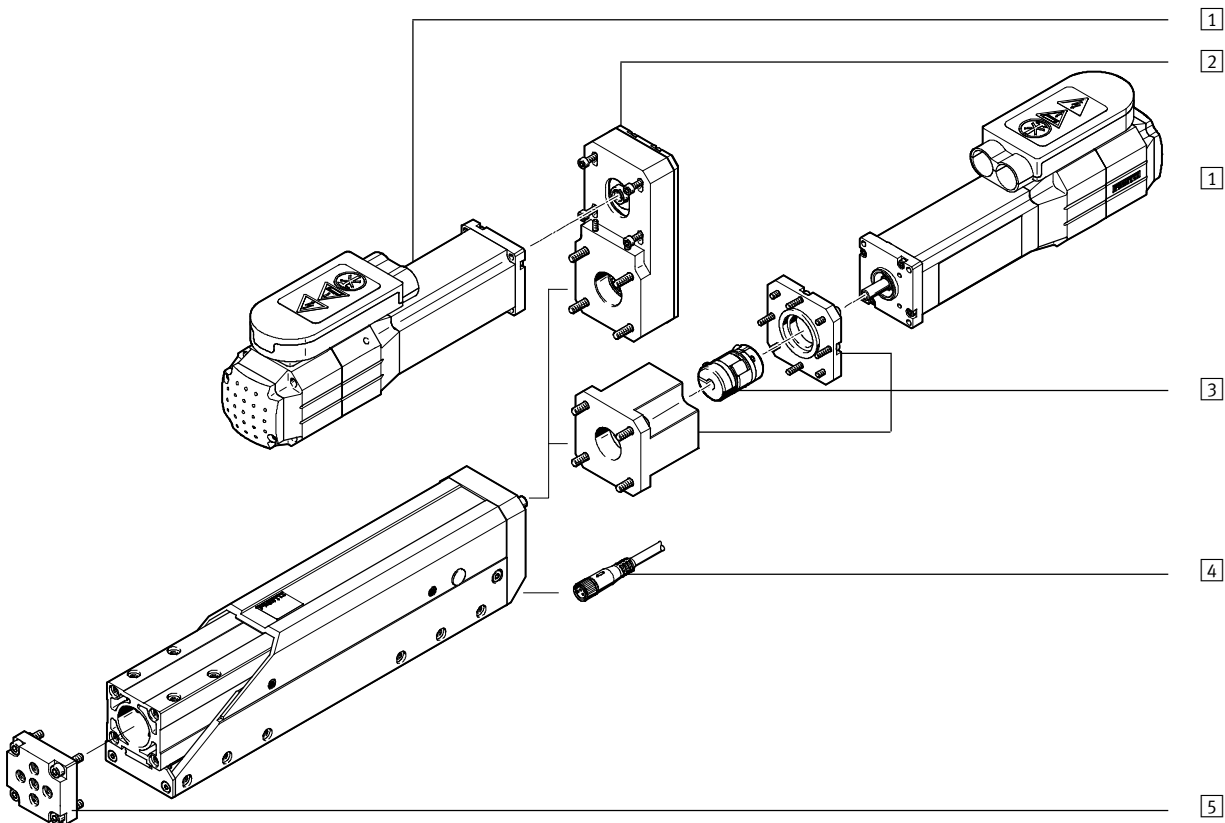

Accessories		
Type	Brief description	→ Page/Internet
1 Motor EMMS	<ul style="list-style-type: none"> <li>Motors specially matched to the axis, with or without brake</li> <li>The motor can be turned by 90° for mounting, depending on requirements. This means the connection side can be freely selected</li> </ul>	11
2 Parallel kit EAMM-U	For parallel motor mounting (consisting of: housing, clamping sleeve, toothed belt pulley, toothed belt)	11
3 Axial kit EAMM-A	For axial motor mounting (consisting of: coupling, coupling housing and motor flange)	11
4 Connecting cable NEBU	For connecting the proximity sensor to a controller. The proximity sensor (N/C contact) is integrated in the spindle driven cantilever axis	12
5 Adapter kit HMSV	Interface between the spindle driven cantilever axis and drive or gripper	12

- 2 - Type discontinued  
Available up until 2013

FESTO

## Cantilever axes EGSA, with spindle drive

Technical data

Function

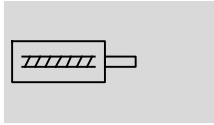

- $\varnothing$  - Size  
50 and 60
- | - Stroke length  
100 ... 300 mm

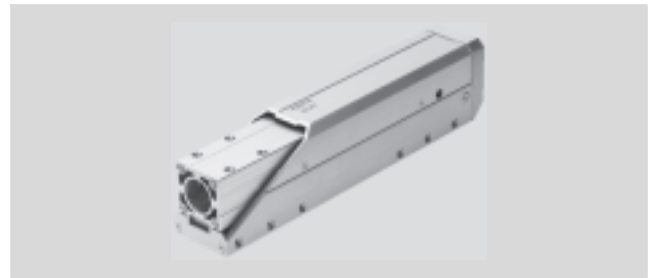

General technical data				
Size	50		60	
Constructional design	Electromechanical cantilever axis with recirculating ball bearing spindle and roller bearing guide			
Working stroke [mm]	100	100	200	300
Stroke reserve [mm]	-3/+7	-4/+9		
Max. speed [m/s]	1.0	1.5		1.0
Max. rotational speed [rpm]	3,000			
Max. acceleration <sup>1)</sup> [m/s <sup>2</sup> ]	15			
Reversing backlash <sup>2)</sup> [mm]	≤ 0.02			
Repetition accuracy [mm]	±0.01			
Position sensing	Sensing of the reference point via integrated reference sensor (N/C contact)			
Type of mounting	Via female thread and centring sleeve			
Mounting position	Any			

1) At max. effective load

2) In new condition

Operating and environmental conditions				
Size	50		60	
Ambient temperature <sup>1)</sup> [°C]	0 ... 50			
Storage temperature [°C]	0 ... 50			
Duty cycle [%]	100			
Noise level [dB]	< 58		< 62	
Protection class	IP20			
Relative air humidity <sup>2)</sup> [%]	0 ... 95			

1) Note operating range of proximity sensors and motors

2) Non-condensing

### Materials

Sectional view

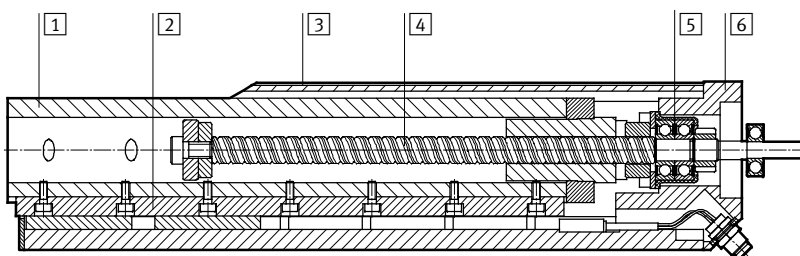

Spindle driven cantilever axis		
1	Cantilever profile	Wrought aluminium alloy, anodised
2	Guide rail	Rolled steel
3	Housing profile, cover	Wrought aluminium alloy, anodised
4	Ball screw	Steel
5	Ball bearing	Steel
6	Spindle bearing plate	Wrought aluminium alloy, anodised
-	Note on material	Conforms to RoHS

## Cantilever axes EGSA, with spindle drive

Technical data

FESTO

Weight					
Size	50		60		
Stroke	[mm]	100	100	200	300
Basic weight	[g]	2,000	3,300	4,200	5,100
Moving load	[g]	750	1,350	1,800	2,250

Mass moment of inertia					
Size	50		60		
Stroke	[mm]	100	100	200	300
Total	[kgmm <sup>2</sup> ]	2	21.9	29.8	37.8
Per kg of effective load	[kgmm <sup>2</sup> /kg]	2.5	16.4		

Mechanical data					
Size	50		60		
Spindle diameter	[mm]	10	12.7		
Spindle pitch	[mm/rev.]	10	25.4		
Max. feed force $F_{xmax}$	[N]	120	240		
Continuous feed force	[N]	100	200		
Max. effective load, horizontal	[kg]	5	10		
Max. effective load, vertical	[kg]	3	6		
Continuous driving torque	[Nm]	0.2	1		
Max. radial force <sup>1)</sup>	[N]	60	110		

1) On the drive shaft

### Calculation of the mean feed force $F_{xm}$

The peak feed force value must not exceed the maximum feed force within a movement cycle. In the case of vertical operation, the peak value is generally

achieved during the acceleration phase of the upwards stroke. If the maximum feed force is exceeded, this can increase wear and thus shorten

the service life of the ball screw spindle. The maximum speed must likewise not be exceeded.

$$F_x \leq F_{xmax}$$

and

$$v_x \leq v_{xmax}$$

#### Mean feed force (to DIN 69 051-4)

During operation, the continuous feed force may be briefly exceeded up to the maximum feed force. The continu-

ous feed force must, however, be adhered to when averaged over a movement cycle.

$$F_{xm} \leq F_{xcont}$$

$$F_{xm} = \sqrt[3]{\sum F_x^3 \times \frac{v_x}{v_{xm}} \times \frac{q}{100}} =$$

$$F_{xm} = \sqrt[3]{F_{x1}^3 \times \frac{v_{x1}}{v_{xm}} \times \frac{q_1}{100} + F_{x2}^3 \times \frac{v_{x2}}{v_{xm}} \times \frac{q_2}{100} + F_{x3}^3 \times \frac{v_{x3}}{v_{xm}} \times \frac{q_3}{100} + \dots}$$

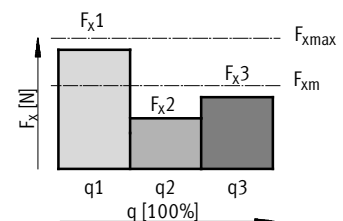

#### Mean feed speed (to DIN 69 051-4)

$$v_{xm} = \sum v_x \times \frac{q}{100} = v_{x1} \times \frac{q_1}{100} + v_{x2} \times \frac{q_2}{100} + v_{x3} \times \frac{q_3}{100} + \dots$$

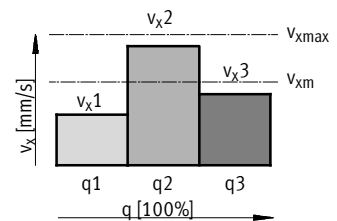

$F_x$	Feed force	$v_x$	Feed speed
$F_{xm}$	Mean feed force	$v_{xm}$	Mean feed speed
$F_{xmax}$	Max. feed force	$v_{xmax}$	Max. feed speed
$F_{xcont}$	Continuous feed force		
$q$	Time		

## Cantilever axes EGSA, with spindle drive

Technical data

### Characteristic load values of the guide

The indicated forces and torques refer to the centre of the guide rail. They must not be exceeded during dynamic operation. Special attention must be paid to the cushioning phase.

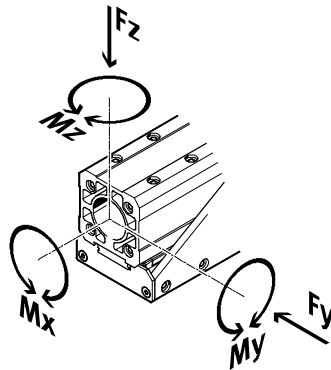

If the cantilever axis is simultaneously subjected to several of the forces and torques listed below, the following equation must be satisfied in addition to the indicated maximum loads:

$$\left| \frac{F_y}{F_{y_{\max.}}} \right| + \left| \frac{F_z}{F_{z_{\max.}}} \right| + \left| \frac{M_x}{M_{x_{\max.}}} \right| + \left| \frac{M_y}{M_{y_{\max.}}} \right| + \left| \frac{M_z}{M_{z_{\max.}}} \right| \leq 1$$

### Permissible forces and torques

Size		50	60
$F_{y_{\max.}}$	[N]	150	200
$F_{z_{\max.}}$	[N]	150	200
$M_{x_{\max.}}$	[Nm]	10	25
$M_{y_{\max.}}$	[Nm]	25	70
$M_{z_{\max.}}$	[Nm]	25	70

- - Note

Sizing software  
PositioningDrives  
→ [www.festo.com](http://www.festo.com)

### Positioning time $t$ as a function of working stroke $l$ and load $m$

EGSA-50-100 with servo motor EMMS-AS-40...

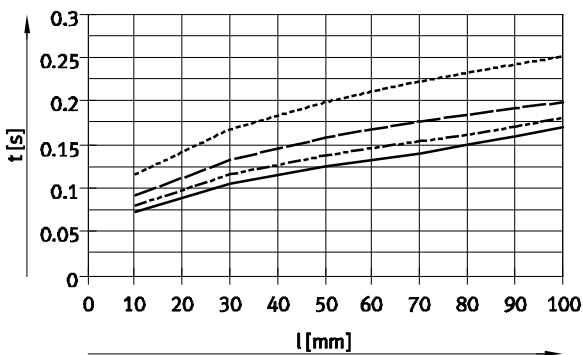

— m = 0 kg  
- - - m = 1 kg  
- - - m = 2 kg  
- - - m = 3 kg

EGSA-60-300 with servo motor EMMS-AS-55...

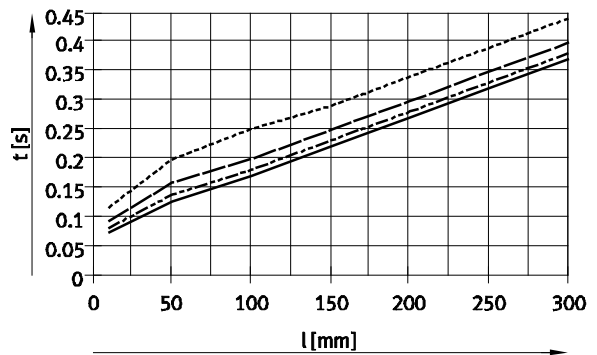

— m = 0 kg  
- - - m = 2 kg  
- - - m = 4 kg  
- - - m = 6 kg

## Cantilever axes EGSA, with spindle drive

Technical data

FESTO

Deflection  $f$  as a function of working stroke  $l$  and effective load  $F$

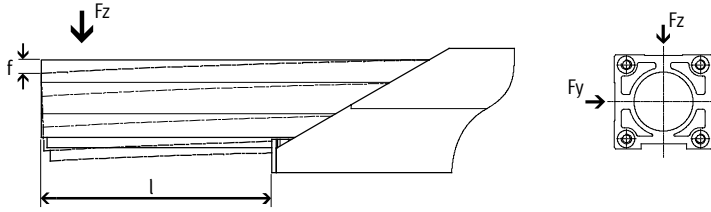

EGSA-50-100

Applied force  $F_y$

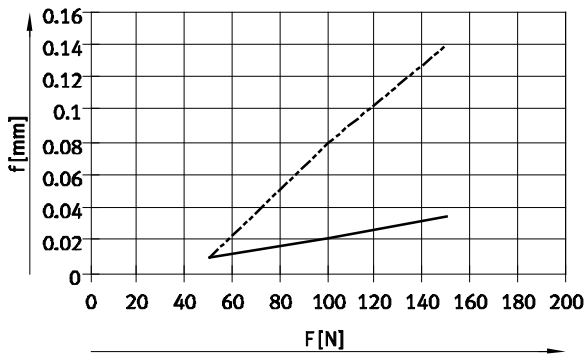

Applied force  $F_z$

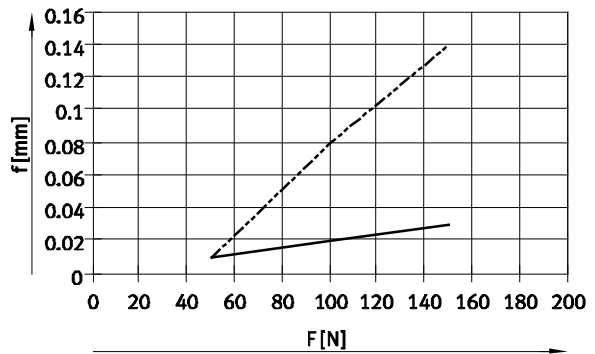

—  $l = 0$  mm  
- - -  $l = 100$  mm

EGSA-60-...

Applied force  $F_y$

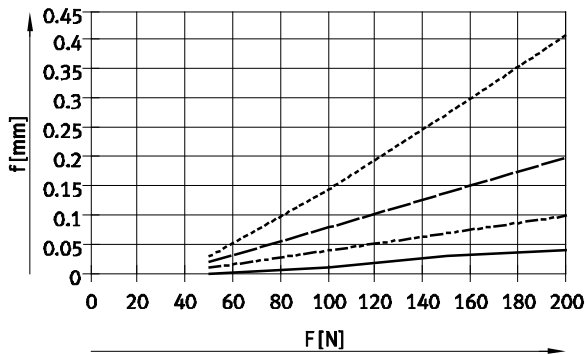

Applied force  $F_z$

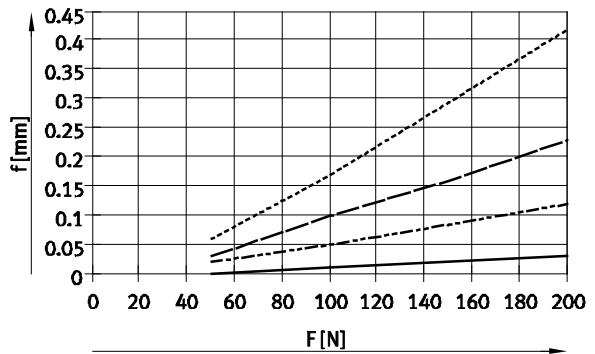

—  $l = 0$  mm  
- - -  $l = 100$  mm  
- · -  $l = 200$  mm  
· · ·  $l = 300$  mm



# Cantilever axes EGSA, with spindle drive

Technical data

## Dimensions

Download CAD data → [www.festo.com](http://www.festo.com)

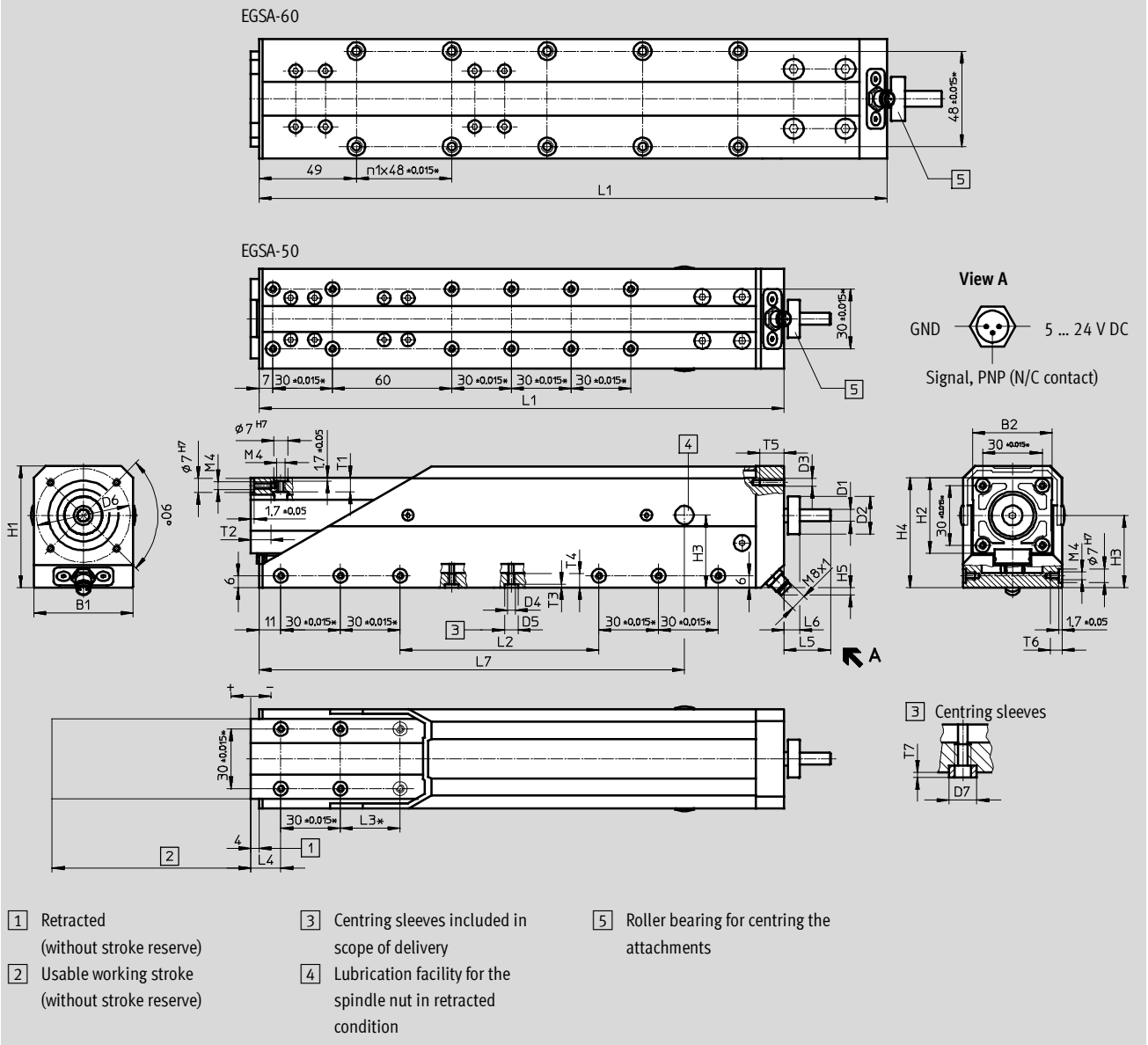

Size	Stroke [2]	Stroke reserve		B1	B2	D1 k6 ∅	D2 -0.01 ∅	D3	D4	D5 H7 ∅	D6 ∅	D7 ∅	H1	H2	H3
		Retracted	Advanced												
50	100	-3	+7	50	40	6	19	M4	M4	7	47	7 <sub>js7</sub>	61.4	38	36.4
60	100	-4	+9	60	48	8	22	M5	M6	9	60	9 <sub>h6</sub>	75	48	45
	200														
	300														

Size	Stroke [2]	H4	H5	L1	L2	L3* ±0.015	L4	L5	L6	L7	n1	T1 min.	T2 min.	T3 ±0.05	T4 min.	T5 min.	T6 min.	T7 ±0.1
60	100	69	1.3	316	152	30	20	27.5	~9	258	4	10	14	2.2	12	11	15	1.8
	200			416	252					358	6							
	300			516	352					458	8							

\* Tolerances for centring holes, ±0.2 for threaded holes

- 1 - Type discontinued  
Available up until 2013

## Cantilever axes EGSA, with spindle drive

FESTO

Technical data

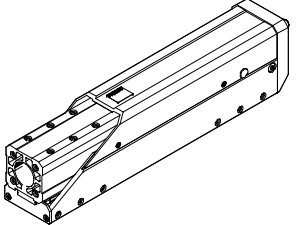

Ordering data				
	Size	Stroke	Part No.	Type
	50	100	558199	EGSA-50-100
	60	100	558200	EGSA-60-100
		200	558201	EGSA-60-200
		300	558202	EGSA-60-300

- 2 - Type discontinued  
Available up until 2013

FESTO

## Cantilever axes EGSA, with spindle

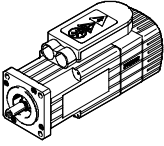
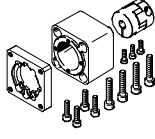
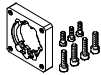
Accessories

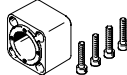
Permissible axis/motor combinations with axial kit				Technical data → Internet: eamm-a
Motor	Axial kit	Axial kit consisting of:		
		Motor flange	Coupling	Coupling housing
				
Type	Part No. Type	Part No. Type	Part No. Type	Part No. Type
<b>EGSA-50</b>				
With servo motor				
EMMS-AS-40-...	559798 EAMM-A-A19-40A	558904 EAMF-A-28C-40A	558901 EAMC-20-30-6-6	559801 EAMK-A-A19-28C
With stepper motor				
EMMS-ST-42-...	558895 EAMM-A-A19-42A	558905 EAMF-A-28C-42A	558902 EAMC-20-30-5-6	559801 EAMK-A-A19-28C
<b>EGSA-60</b>				
With servo motor				
EMMS-AS-55-...	559799 EAMM-A-A22-55A	559800 EAMF-A-38C-55A	557390 EAMC-30-35-8-9	559802 EAMK-A-A22-38C
EMMS-AS-70-...	558898 EAMM-A-A22-70A	558908 EAMF-A-38C-70A	123042 EAMC-30-35-8-11	559802 EAMK-A-A22-38C
With stepper motor				
EMMS-ST-57-...	558897 EAMM-A-A22-57A	558907 EAMF-A-38C-57A	530088 EAMC-30-35-6.35-8	559802 EAMK-A-A22-38C

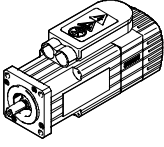
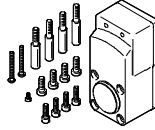
Permissible axis/motor combinations with parallel kit		Technical data → Internet: eamm-u
Motor	Parallel kit	
		
Type	Part No.	Type
<b>EGSA-50</b>		
With servo motor		
EMMS-AS-40-...	559785	EAMM-U-A19-40A
<b>EGSA-60</b>		
With servo motor		
EMMS-AS-55-...	559786	EAMM-U-A22-55A
EMMS-AS-70-...	559787	EAMM-U-A22-70A

- 3 - Note

Technical data for motors

→ Internet: motor



- 1 - Type discontinued  
Available up until 2013

## Cantilever axes EGSA, with spindle

Accessories

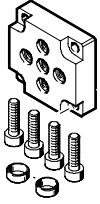
FESTO

Ordering data – Adapter kits				
	Comment	For size	Part No.	Type
	Drive/drive connections, drive/gripper connections → Internet: hmsv	50	560017	HMSV-61
		60	560018	HMSV-62
			560019	HMSV-63

Ordering data – Connecting cables				Technical data → Internet: nebu	
	Electrical connection, left	Electrical connection, right	Cable length [m]	Part No.	Type
	Straight socket, M8x1, 3-pin	Cable, open end, 3-wire	2.5	541333	NEBU-M8G3-K-2.5-LE3
			5	541334	NEBU-M8G3-K-5-LE3
	Angled socket, M8x1, 3-pin	Cable, open end, 3-wire	2.5	541338	NEBU-M8W3-K-2.5-LE3
			5	541341	NEBU-M8W3-K-5-LE3