

**Bellows cylinders EB/EBS**



- 1 - Type discontinued EBS  
Available up until 2011

## Bellows cylinders EB/EBS

Key features, product range overview and type code

### Key features



Bellows cylinders function both as driving and pneumatic spring components. Bellows cylinders function as a driving component by providing pressurising and exhaust functions. As the stroke increases, the force generated is reduced in relation the contractional force of

the bellows. When bellows cylinders are supplied with permanent pressure, they function as a cushioning component. The simple design consists of two metal plates with a ribbed rubber bellows. There are no sealing components and no moving mechanical parts. Bellows cylinders

are single-acting drives that do not require spring returns, as the reset is performed through the application of external force. Rolling bellows have a different stroke/force characteristic to conventional bellows and can cover

a wider stroke range in relation to installation height. With rolling bellows cylinders, the reduction in force only begins due to the contractional force of the bellows after approximately 50% of the stroke travelled.

### Product range overview

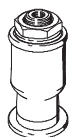
Function	Variant	Type	Size	Stroke [mm]	→ Page/Internet
Single-acting	<b>Bellows</b>				
		EB Single-bellows cylinder	145	60	3
			165	65	
			215	80	
			250	85	
			325	95	
			385	115	
		EB Double-bellows cylinder	145	100	3
			165	125	
			215	155	
			250	185	
			325	215	
			385	230	
	<b>Rolling bellows</b>				
	EBS Rolling bellows	80	110	12	
		100	105		

### Type codes



		EB	–	250	–	85
<b>Type</b>						
Single-acting						
EB	Bellows					
EBS	Rolling bellows					
<b>Size</b>						
<b>Stroke [mm]</b>						

# Bellows cylinders EB

Technical data

Function



-  - Diameter  
145 ... 385 mm
-  - Stroke length  
60 ... 230 mm



General technical data						
Size	145	165	215	250	325	385
Pneumatic connection	G $\frac{1}{8}$	G $\frac{1}{4}$	G $\frac{3}{4}$	G $\frac{3}{4}$	G $\frac{1}{4}$	G $\frac{1}{4}$
Mode of operation	Single-acting					
Design	Bellows					
Type of mounting	With female thread					
Mounting position	Any					

Operating and environmental conditions	
Operating medium	Filtered compressed air, lubricated or unlubricated
Operating pressure [bar]	0 ... 8
Ambient temperature [°C]	-40 ... +70
Corrosion resistance class CRC <sup>1)</sup>	2

1) Corrosion resistance class 2 to Festo standard 940 070  
Components subject to moderate corrosion stress. Externally visible parts with primarily decorative surface requirements which are in direct contact with a normal industrial environment or media such as coolants or lubricating agents

Forces [N]						
Size	145	165	215	250	325	385
Single-bellows cylinder						
Force/stroke curve	→ 4		→ 5			
Resetting force	200				300	
Double-bellows cylinder						
Force/stroke curve	→ 6		→ 7			
Resetting force	200				300	

-  - Note
- Bellows cylinders may only be driven against a workpiece, or they must be equipped with stroke limiting stops at the stroke ends, because the bellows would otherwise be overloaded
  - A resetting force is required in order to press the bellows cylinder together to its minimum height. As a rule, this is achieved through the applied load
  - The entire bearing surfaces of the upper and lower plates must be utilised in order to absorb forces
  - Bellows cylinders must be exhausted before disassembly
  - The rubber bellows must not come into contact with other parts during operation

# Bellows cylinders EB

Technical data



Weights [g]						
Size	145	165	215	250	325	385
Single-bellows cylinder	900	1,200	2,000	2,300	4,100	5,800
Double-bellows cylinder	1,100	1,500	2,300	3,000	4,800	6,900

## Materials

Sectional view

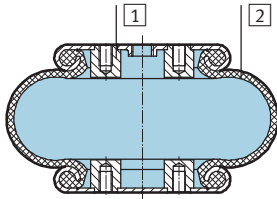

Bellows cylinder		
1	Housing	Galvanised steel
2	Bellows	Rubber
-	Note on materials	Free of copper, PTFE and silicone
		Conforms to RoHS

## Thrust F and bellows volume V as a function of the minimum installation height H2 + stroke length

The diagram illustrates the change in thrust F with various working pressures and differing bellows volumes V in relation to stroke length. The

minimum installation height H2 must be observed in order to fully reach the indicated forces.

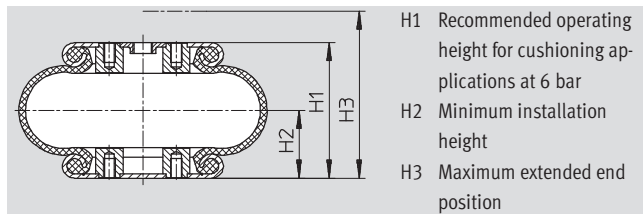

- H1 Recommended operating height for cushioning applications at 6 bar
- H2 Minimum installation height
- H3 Maximum extended end position

## Single-bellows cylinder

EB-145-60

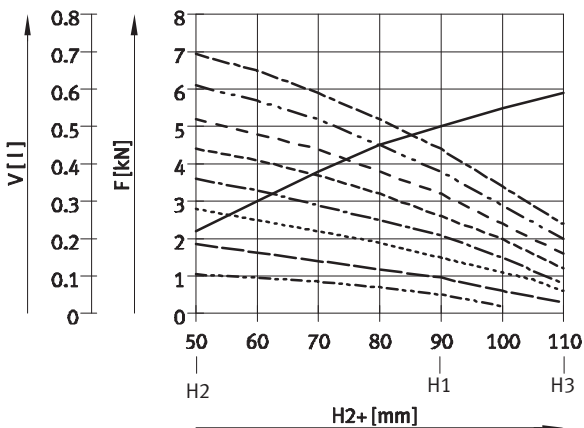

EB-165-65

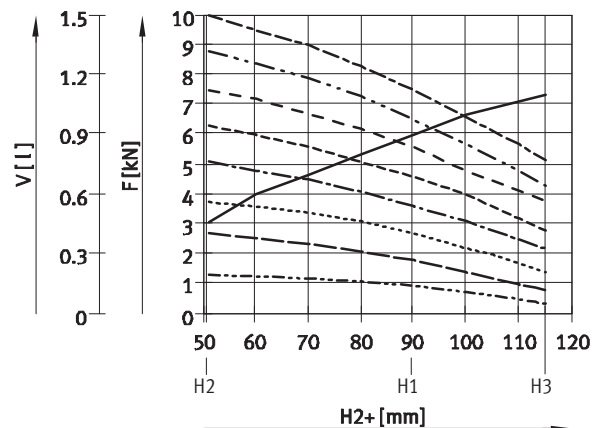

+ plus stroke length

- |       |        |       |       |       |       |
|-------|--------|-------|-------|-------|-------|
| ————— | Volume | ..... | 3 bar | ----- | 6 bar |
| ----- | 1 bar  | ----- | 4 bar | ----- | 7 bar |
| ----- | 2 bar  | ----- | 5 bar | ----- | 8 bar |

# Bellows cylinders EB

Technical data

FESTO

## Single-bellows cylinder

EB-215-80

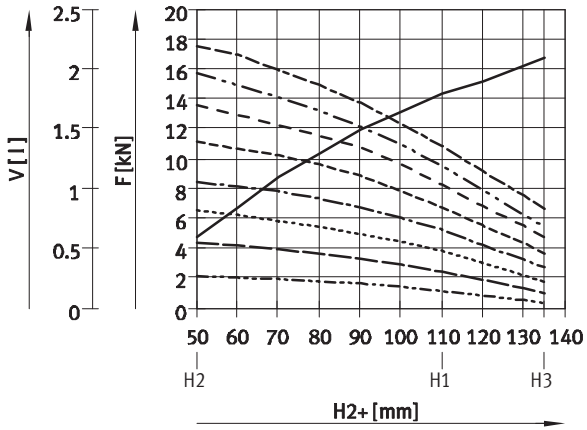

EB-250-85

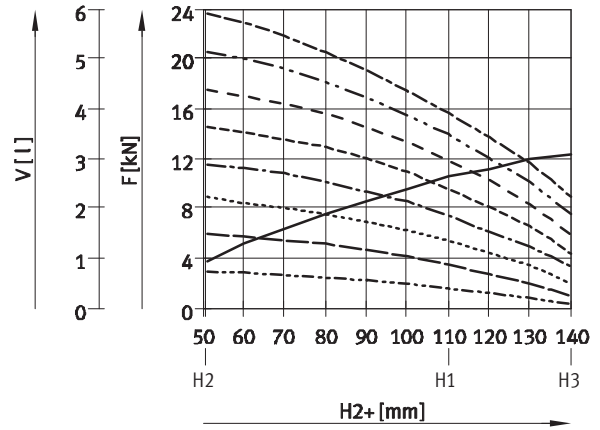

EB-325-95

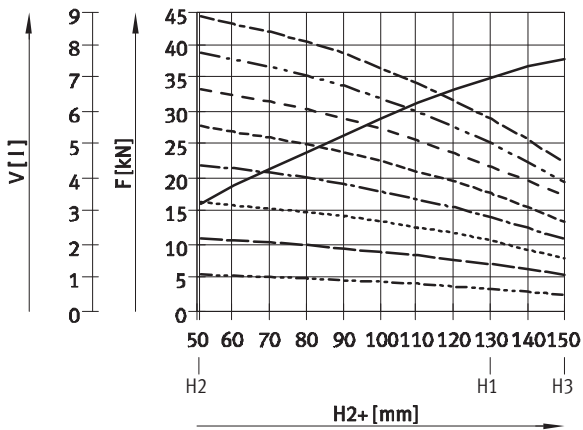

EB-385-115

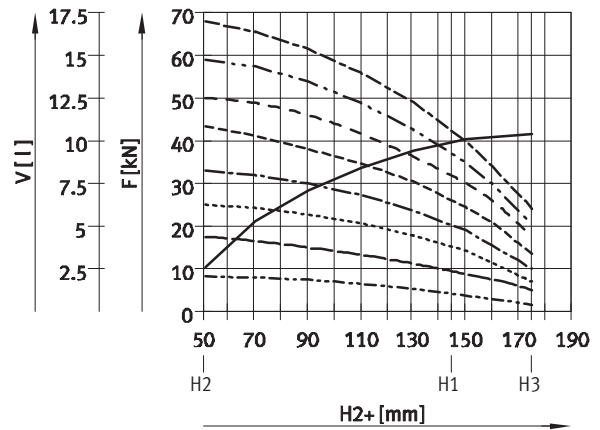

+ plus stroke length

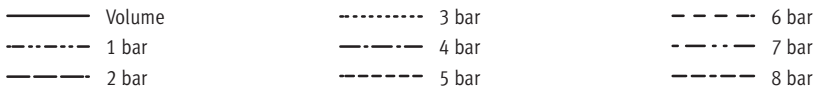

# Bellows cylinders EB

Technical data



## Thrust F and bellows volume V as a function of the minimum installation height H2 + stroke length

The diagram illustrates the change in thrust F with various working pressures and differing bellows volumes V in relation to stroke length. The

minimum installation height H2 must be observed in order to fully reach the indicated forces.

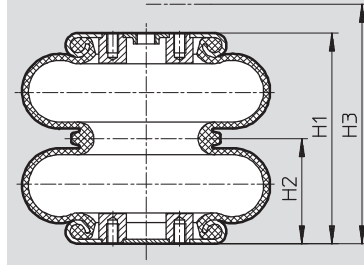

- H1 Recommended operating height for cushioning applications at 6 bar
- H2 Minimum installation height
- H3 Maximum extended end position

## Double-bellows cylinder

EB-145-100

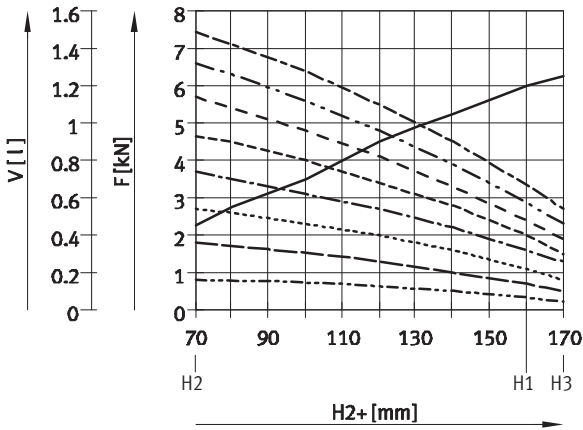

EB-165-125

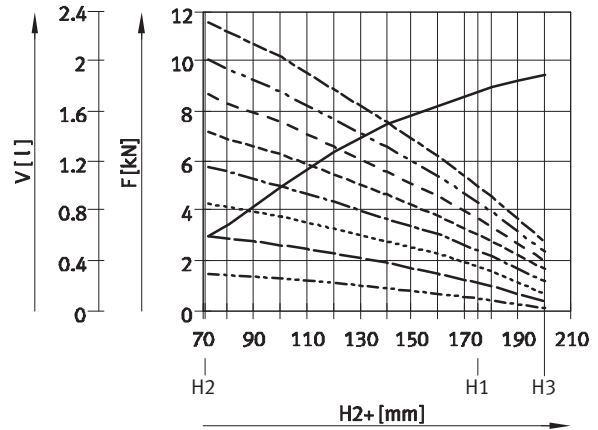

+ plus stroke length

- |             |             |             |
|-------------|-------------|-------------|
| — Volume    | ----- 3 bar | ----- 6 bar |
| ----- 1 bar | ----- 4 bar | ----- 7 bar |
| ----- 2 bar | ----- 5 bar | ----- 8 bar |

# Bellows cylinders EB

Technical data

## Double-bellows cylinder

EB-215-155

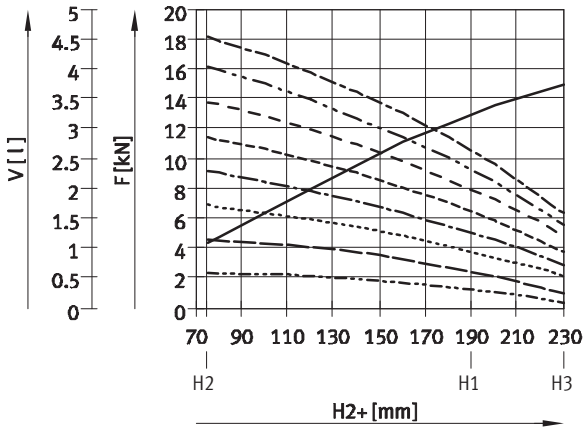

EB-250-185

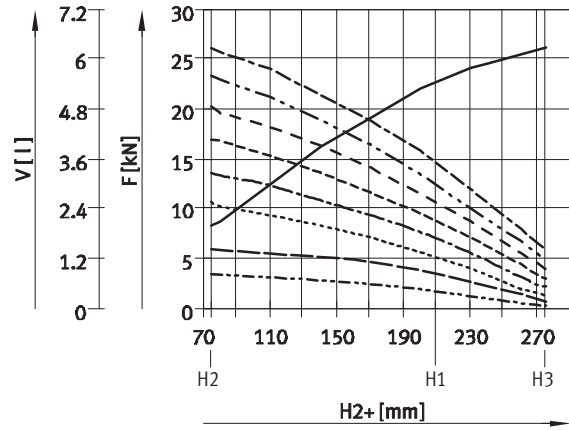

EB-325-215

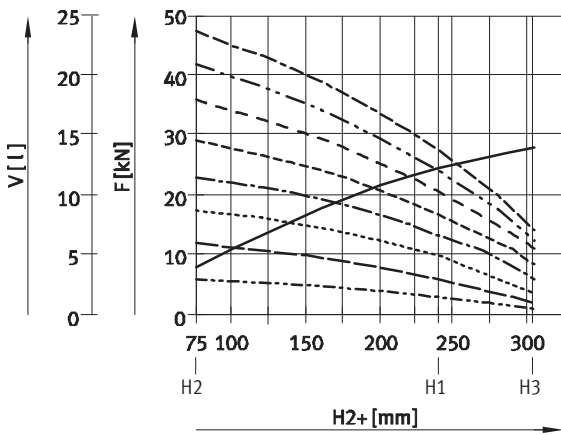

EB-385-230

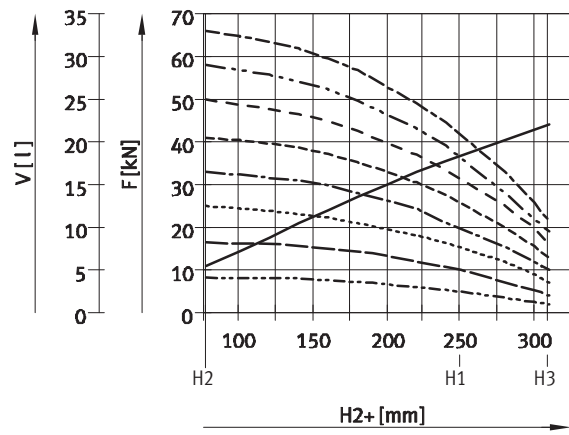

+ plus stroke length

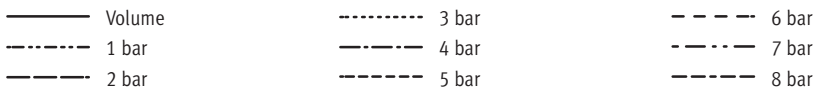

# Bellows cylinders EB

Technical data

FESTO

## Dimensions – Single-bellows cylinder

Download CAD data → [www.festo.com](http://www.festo.com)

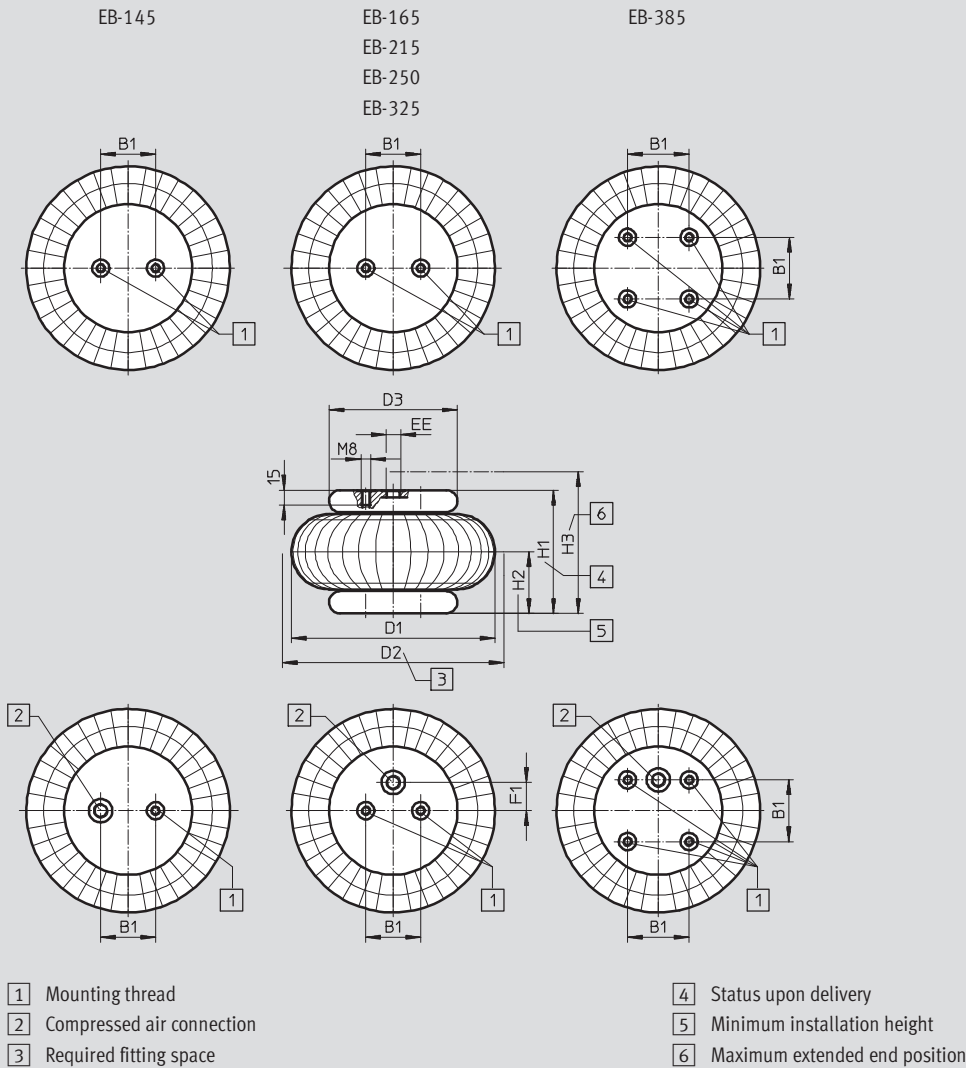

## Maximum offset between the mounting surfaces

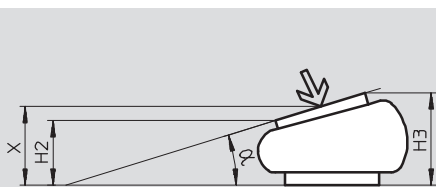
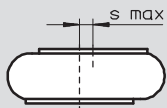

- Note

The stroke of the bellows cylinder can be made to describe a circular arc, in which case the indicated tilt angle  $\alpha$  must not be exceeded. During setup it must be observed that the minimum height H2 is not fallen short of, and

that the maximum height H3 is not exceeded at any given point. The height at the centre of the plate X is the decisive factor in the calculation of the thrust.



# Bellows cylinders EB

Technical data

Type	B1 ±0.2	D1 ∅ max.	D2 ∅	D3 ∅	EE	F1 ±0.2	H1	H2 min.	H3 max.	S <sub>max</sub>	Tilt angle α max.
EB-145-60	20	145	160	90	G $\frac{1}{8}$	-	90	50	110	10	20°
EB-165-65	44.5	165	180	108	G $\frac{1}{4}$	0	90	51	115	10	20°
EB-215-80	70	215	230	141	G $\frac{3}{4}$	0	110	50	135	10	20°
EB-250-85	89	250	265	161	G $\frac{3}{4}$	38.1	110	51	140	10	20°
EB-325-95	157.5	325	340	228	G $\frac{1}{4}$	73	130	51	150	10	15°
EB-385-115	158.8	385	400	287	G $\frac{1}{4}$	79.4	145	51	175	10	15°

Ordering data – Single-bellows cylinder			
Size	Stroke [mm]	Part No.	Type
145	60	<b>36 486</b>	<b>EB-145-60</b>
165	65	<b>36 487</b>	<b>EB-165-65</b>
215	80	<b>36 488</b>	<b>EB-215-80</b>
250	85	<b>36 489</b>	<b>EB-250-85</b>
325	95	<b>193 788</b>	<b>EB-325-95</b>
385	115	<b>193 789</b>	<b>EB-385-115</b>

# Bellows cylinders EB

Technical data

FESTO

## Dimensions – Double-bellows cylinder

Download CAD data → [www.festo.com](http://www.festo.com)

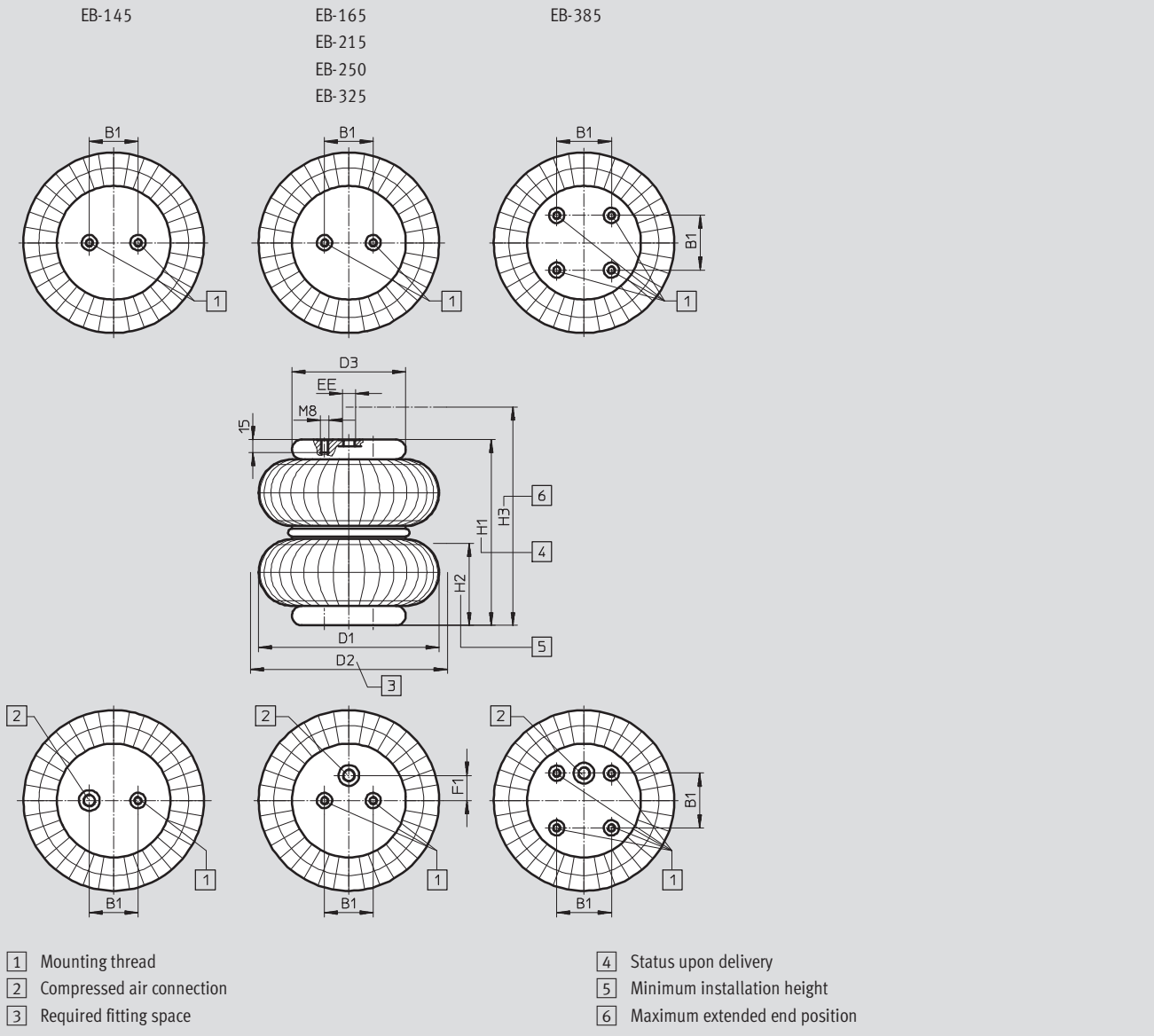

## Maximum offset between the mounting surfaces

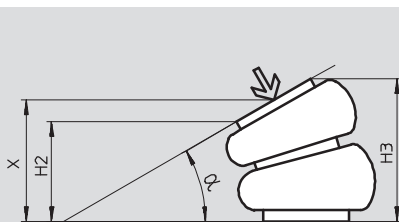
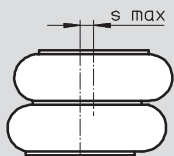

- Note

The stroke of the bellows cylinder can be made to describe a circular arc, in which case the indicated tilt angle  $\alpha$  must not be exceeded. During setup it must be observed that the minimum height H2 is not fallen short of, and

that the maximum height H3 is not exceeded at any given point. The height at the centre of the plate X is the decisive factor in the calculation of the thrust.

## Bellows cylinders EB

Technical data

Type	B1 ±0.2	D1 ∅ max.	D2 ∅	D3 ∅	EE	F1 ±0.2	H1	H2 min.	H3 max.	S <sub>max</sub>	Tilt angle α max.
EB-145-100	20	145	160	90	G $\frac{1}{8}$	–	160	70	170	20	30°
EB-165-125	44.5	165	180	108	G $\frac{1}{4}$	0	175	72	200	20	30°
EB-215-155	70	215	230	141	G $\frac{3}{4}$	0	190	75	230	20	30°
EB-250-185	89	250	265	161	G $\frac{3}{4}$	38.1	210	75	275	20	25°
EB-325-215	157.5	325	340	228	G $\frac{1}{4}$	73	240	75	305	20	20°
EB-385-230	158.8	385	400	287	G $\frac{1}{4}$	79.4	250	77	310	20	20°

Ordering data – Double-bellows cylinder			
Size	Stroke [mm]	Part No.	Type
145	100	<b>36 490</b>	<b>EB-145-100</b>
165	125	<b>36 491</b>	<b>EB-165-125</b>
215	155	<b>36 492</b>	<b>EB-215-155</b>
250	185	<b>36 493</b>	<b>EB-250-185</b>
325	215	<b>193 790</b>	<b>EB-325-215</b>
385	230	<b>193 791</b>	<b>EB-385-230</b>

-  - Type discontinued  
Available up until 2011

## Bellows cylinders EBS

Technical data

FESTO

Function



-  - Diameter  
80 and 100 mm

-  - Stroke length  
105 and 110 mm



General technical data	
Size	80   100
Pneumatic connection	G3/8
Mode of operation	Single-acting
Design	Rolling bellows
Type of mounting	With female thread
Mounting position	Any

Operating and environmental conditions	
Operating medium	Filtered compressed air, lubricated or unlubricated
Operating pressure [bar]	0.9 ... 8.0
Ambient temperature [°C]	-40 ... +70
Corrosion resistance class CRC <sup>1)</sup>	2

1) Corrosion resistance class 2 to Festo standard 940 070  
Components subject to moderate corrosion stress. Externally visible parts with primarily decorative surface requirements which are in direct contact with a normal industrial environment or media such as coolants or lubricating agents

Forces [N]	
Size	80   100
Force/stroke curve	→ 13
Resetting force	350   450

-  - Note

- Bellows cylinders may only be driven against a workpiece, or they must be equipped with stroke limiting stops at the stroke ends, because the bellows would otherwise be overloaded
- A resetting force is required in order to press the bellows cylinder together to its minimum height. As a rule, this is achieved through the applied load
- Rolling bellows require a minimum pressure of 0.9 bar in order to be able to roll on the piston. Consequently they must not be pushed back to their initial position when in the unpressurised state as this will damage the tube
- The entire bearing surfaces of the upper and lower plates must be utilised in order to absorb forces
- The rubber bellows must not come into contact with other parts during operation
- Bellows cylinders must be exhausted before disassembly

## Bellows cylinders EBS

Technical data

Weights [g]		
Size	80	100
Product weight	400	500

### Materials

Sectional view

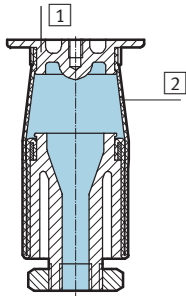

Bellows cylinder		
1	Housing	Polyamide, fibreglass reinforced
2	Bellows	Rubber
-	Note on materials	Free of copper, PTFE and silicone

### Thrust F and bellows volume V as a function of the minimum installation height H2 + stroke length

The diagrams illustrate the change in thrust F with various working pressures and differing bellows volumes V in relation to stroke length. The

minimum installation height H2 must be observed in order to fully reach the indicated forces.

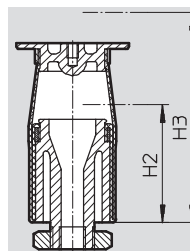

H2 Minimum installation height  
H3 Maximum extended end position

#### EBS-80-110

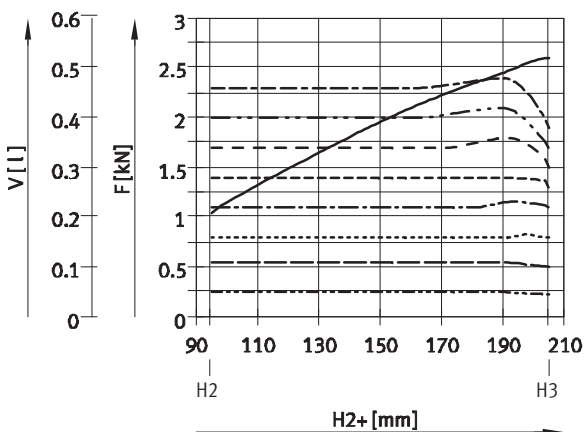

+ plus stroke length

— Volume  
- - - 1 bar  
- - - 2 bar  
- - - 3 bar  
- - - 4 bar  
- - - 5 bar

#### EBS-100-105

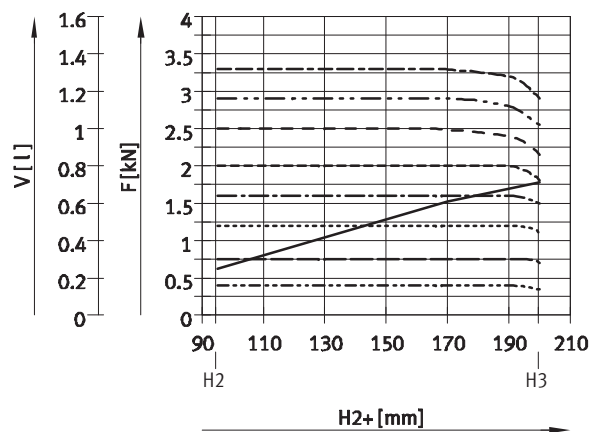

- - - 6 bar  
- - - 7 bar  
- - - 8 bar

-  - Type discontinued  
Available up until 2011

## Bellows cylinders EBS

Technical data

FESTO

### Dimensions – Rolling bellows

Download CAD data → [www.festo.com](http://www.festo.com)

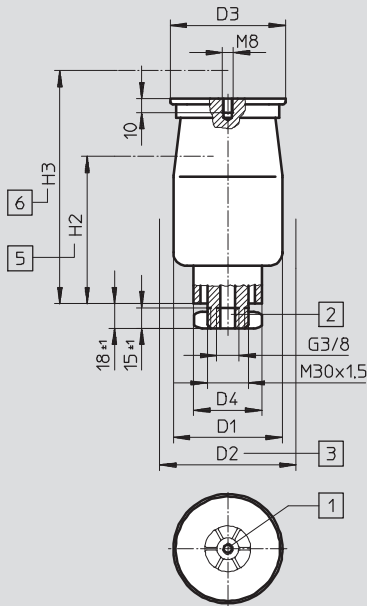

- 1 Mounting thread
- 2 Compressed air connection
- 3 Required fitting space
- 5 Minimum installation height
- 6 Maximum extended end position

### Maximum offset between the mounting surfaces

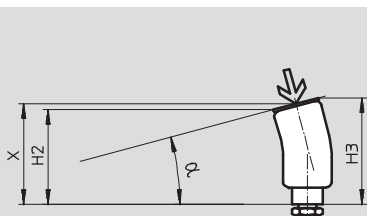
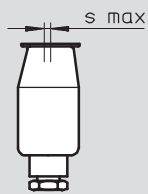

 Note

The stroke of the bellows cylinder can be made to describe a circular arc, in which case the indicated tilt angle  $\alpha$  must not be exceeded. During setup it must be observed that the minimum height H2 is not fallen short of, and

that the maximum height H3 is not exceeded at any given point. The height at the centre of the plate X is the decisive factor in the calculation of the thrust.

Type	D1 ∅ max.	D2 ∅	D3 ∅ ±1	D4 ∅ ±0.5	H2 min.	H3 max.	s <sub>max</sub>	Tilt angle $\alpha$ max.
EBS-80-110	80	100	76.5	50	95	205	10	15°
EBS-100-105	97	115	86.5	60.5	95	200	10	15°

### Ordering data – Rolling bellows

Size	Stroke [mm]	Part No.	Type
80	110	193 794	EBS-80-110
100	105	193 795	EBS-100-105