



Linear actuators DLP, Copac

FESTO



Characteristics and type codes

General information

-  - Diameter
80 ... 320 mm
-  - Stroke length
40 ... 600 mm, additional
stroke lengths on request
-  - Force
2800 ... 48000 N

The linear actuators Copac are ideally suited for use in water, wastewater, service water, process water and bulk material technology as well as the silo and paper industry. A clean solution for shut-off, inspection, safety and control slide valves. The linear actuator Copac acts directly on the slide gate and ensures that various positions can be approached accurately.

- Fast or slow valve actuation
- Position sensing
- Internal air channels eliminate protruding tubing and attachments, and thus also undesirable accumulation of contaminants
- Suitable for manual on-site use, as well as automatic operation
- Opening and closing actuated via flange-mounted solenoid valve with port pattern to Namur, or via valve terminals with a choice of 30 different fieldbus protocols
- Sturdy and reliable, even in aggressive environments
- High corrosion resistance
- Mounting hole pattern to DIN 3358/ISO 5210 for direct attachment
- Port pattern to Namur VDI/VDE 3845 for mounting solenoid valves



Type codes

001	Series
DLP	Double-acting linear drive

002	Piston diameter
80	80
100	100
125	125
160	160
200	200
250	250
320	320

003	Stroke
...	40 ... 600

004	Position sensing
A	For proximity sensor

Peripherals overview

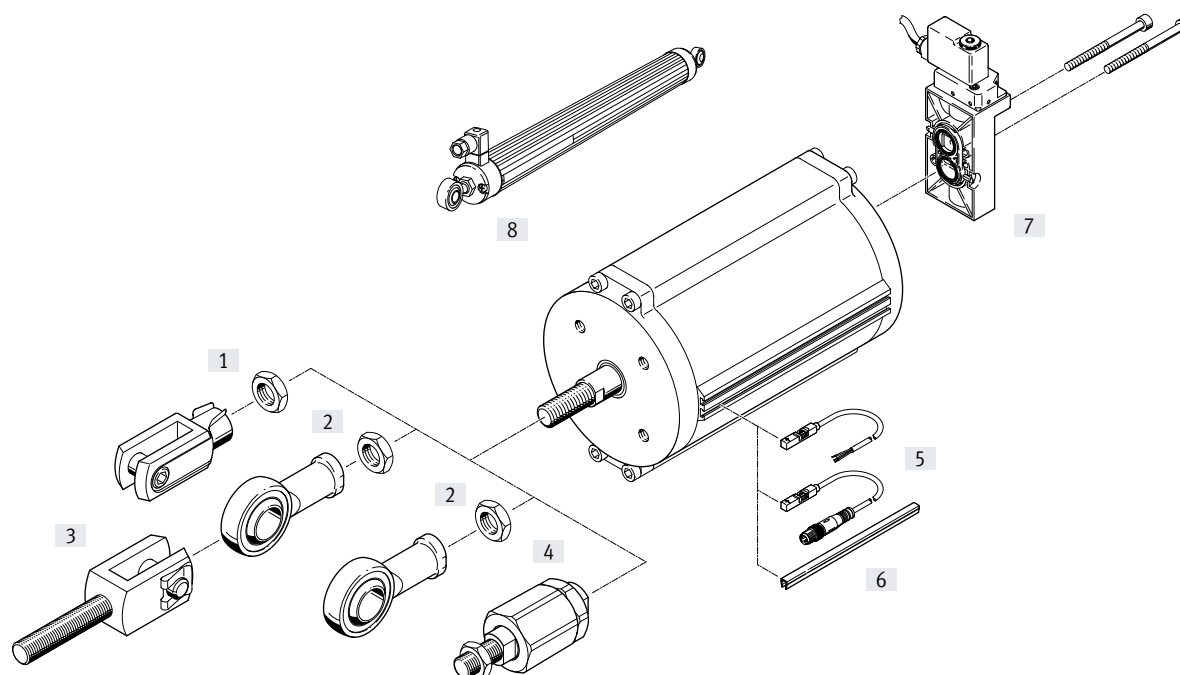

Mounting components and accessories		Description	DLP-8 0/100	DLP-12 5/160	DLP-200 ... 320	→ Page/Internet
[1]	Rod clevis SG	Enables a simple connection between the piston rod and slide gate	■	■	■	9
	Rod clevis, stainless steel CRSG		■	■	–	9
[2]	Rod eye SGS	With spherical bearing	■	■	■	9
	Rod eye, stainless steel CRSGS		■	■	–	9
[3]	Rod clevis SGA	With male thread	■	■	■	9
[4]	Self-aligning rod coupler FK/CRFK	For compensating radial and angular deviations	■	■	■	9
[5]	Proximity switch SMT-8M-A	Magneto-resistive, 5 ... 30 V DC, to EU Explosion Protection Directive (ATEX)	■	■	■	10
	Proximity switch CRSMT-8		■	■	■	10
	Proximity switch SDBT		Magneto-resistive, NAMUR, to EU Explosion Protection Directive (ATEX)	■	■	■
[6]	Slot cover ABP-5-S	To protect the sensor cables and slots from contamination	■	■	■	11
[7]	Solenoid valves	Namur port pattern, not with [8] or [10]	■	■	■	solenoid valve
[8]	Displacement encoder MLO-POT	Conversion of the linear motion into an electric voltage signal. The maximum stroke is 700 mm.	■	■	■	9

Data sheet

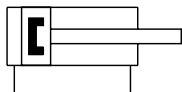

- | - Stroke length
40 ... 600 mm, additional stroke lengths on request
- ≡ - Force
2800 ... 48000 N



General technical data							
Piston diameter	80	100	125	160	200	250	320
Pneumatic connection	G1/4						
Based on standard	DIN 3358						
Valve connection conforms to standard	VDI/VDE 3845 (NAMUR)						
Mode of operation	Double-acting						
Design	Piston cylinder						
Cushioning	None						
Stroke reserve [mm]	2					4	
Mounting position	Any						
Position sensing	Via proximity switch						
Valve actuator efficiency [%]	95						

Operating and environmental conditions	
Operating pressure ¹⁾ [bar]	2 ... 8
Nominal operating pressure [bar]	6
Operating medium	Compressed air to ISO 8573-1:2010 [7:4:4]
Note on operating/pilot medium	Lubricated operation possible (in which case lubricated operation will always be required)
Ambient temperature ²⁾³⁾ [°C]	-20 ... +80
Corrosion resistance CRC ⁴⁾	3

- 1) Depending on the counter force of the valve slide, a higher minimum pressure may be required to actuate the overall system
- 2) Additional temperature ranges available on request
- 3) Note operating range of proximity switches
- 4) Corrosion resistance class CRC 3 to Festo standard FN 940070
High corrosion stress. Outdoor exposure under moderate corrosive conditions. Externally visible parts with primarily functional surface requirements which are in direct contact with a normal industrial environment.

ATEX	
ATEX category for gas	II 2G
Type of ignition protection for gas	Ex h IIC T4 Gb
ATEX category for dust	II 2D
Type of ignition protection for dust	Ex h IIIC T120°C Db
Explosion-proof ambient temperature ¹⁾	-20°C ≤ Ta ≤ +60°C
CE marking (see declaration of conformity)	To EU Explosion Protection Directive (ATEX)

- 1) Note operating range of proximity switches

Data sheet

Forces [N] and air consumption [NI]							
Piston diameter	80	100	125	160	200	250	320
Theoretical force at 6 bar, advancing	3016	4712	7363	12064	18850	29542	48255
Theoretical force at 6 bar, retracting	2827	4524	6881	11581	18080	28698	47501
Theoretical air consumption at 6 bar and 10 mm stroke, pushing	0.35	0.55	0.86	1.41	2.12	3.44	5.63
Theoretical air consumption at 6 bar and 10 mm stroke, pulling	0.33	0.53	0.80	1.35	2.11	3.35	5.54

Weight [g]							
Piston diameter	80	100	125	160	200	250	320
Basic weight with 0 mm stroke	1843	2801	4855	5854	12831	21117	33907
Additional weight per 10 mm stroke	68	80	145	159	187	325	399
Moving mass with 0 mm stroke	624	997	1809	2183	4691	6650	11040
Additional moving mass per 10 mm stroke	25	25	63	63	99	99	99

Materials

Sectional view

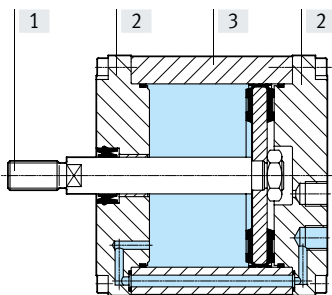

Linear actuators						
[1]	Piston rod	<table border="1"> <tr> <td>∅ 80 ... 320</td> <td>High-alloy stainless steel</td> </tr> </table>	∅ 80 ... 320	High-alloy stainless steel		
∅ 80 ... 320	High-alloy stainless steel					
[2]	Cover	<table border="1"> <tr> <td>∅ 80 ... 160, 250, 320</td> <td>Wrought aluminium alloy</td> </tr> <tr> <td>∅ 200</td> <td>Cast aluminium</td> </tr> </table>	∅ 80 ... 160, 250, 320	Wrought aluminium alloy	∅ 200	Cast aluminium
∅ 80 ... 160, 250, 320	Wrought aluminium alloy					
∅ 200	Cast aluminium					
[3]	Housing	<table border="1"> <tr> <td>∅ 80 ... 160, 250</td> <td>Smooth-anodised wrought aluminium alloy</td> </tr> <tr> <td>∅ 200, 320</td> <td>High-alloy steel</td> </tr> </table>	∅ 80 ... 160, 250	Smooth-anodised wrought aluminium alloy	∅ 200, 320	High-alloy steel
∅ 80 ... 160, 250	Smooth-anodised wrought aluminium alloy					
∅ 200, 320	High-alloy steel					
-	Seals	<table border="1"> <tr> <td>∅ 80 ... 320</td> <td>NBR</td> </tr> <tr> <td>∅ 80, 100, 320</td> <td>NBR, TPE-U (PU)</td> </tr> </table>	∅ 80 ... 320	NBR	∅ 80, 100, 320	NBR, TPE-U (PU)
∅ 80 ... 320	NBR					
∅ 80, 100, 320	NBR, TPE-U (PU)					

Data sheet

Dimensions

Download CAD data → www.festo.com

∅ 80 ... 160

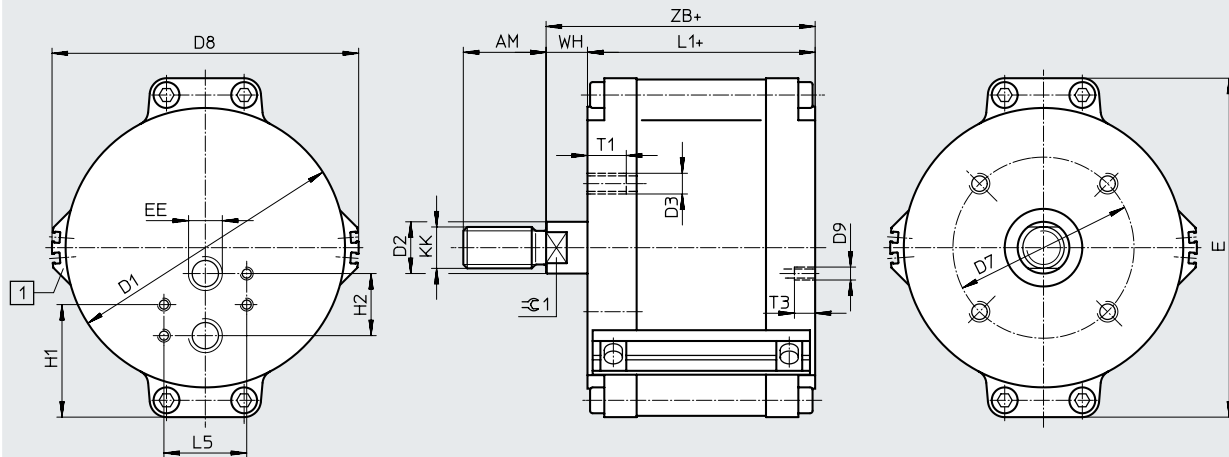

∅ 200 ... 320

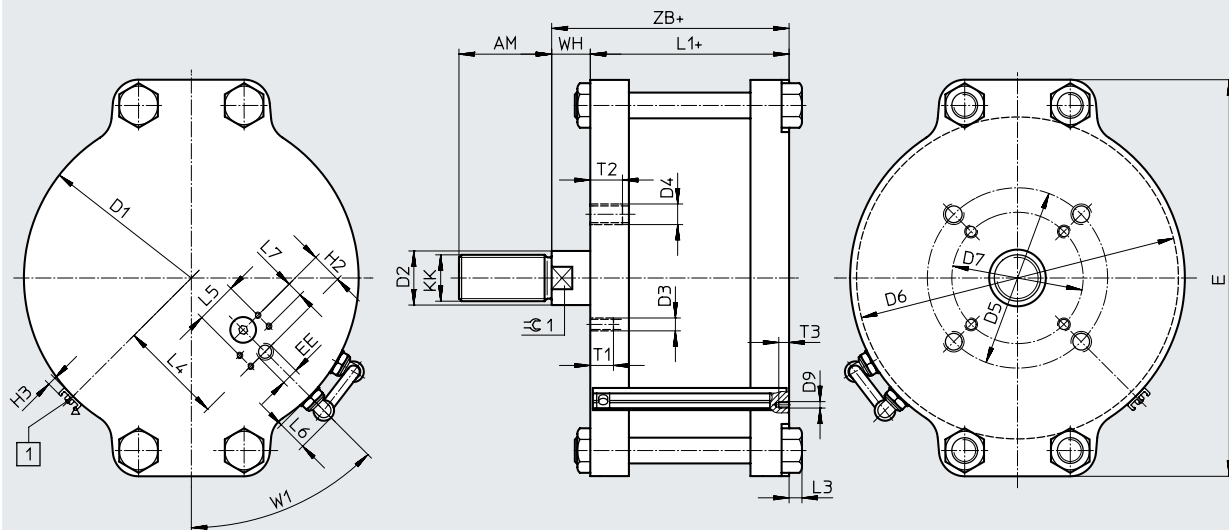

[1] Mounting rail for proximity switches SME/SMT-8

+ = plus stroke length

Data sheet

∅ [mm]	AM	D1 ∅	D2 ∅	D3 ∅	D4 ∅	D5 ∅	D6 ∅	D7 ∅	D8 ∅	D9 ∅	E	EE	H1	H2	H3
	-2														
DLP-80-...-A	32	87	20	M8	-	-	-	70	99	M5	108	G1/4	43.5	24	-
DLP-100-...-A	32	108	20	M8	-	-	-	70	119	M5	131	G1/4	43.5	24	-
DLP-125-...-A	54	135	32	M10	-	-	-	102	147	M5	163	G1/4	43.5	24	-
DLP-160-...-A	54	170	32	M10	-	-	-	102	182	M5	199	G1/4	43.5	24	-
DLP-200-...-A	72	216	40	M10	M16	140	210	102	-	M5	271	G1/4	43.5	24	4.5
DLP-250-...-A	72	260	40	M10	M16	140	244	102	-	M5	308	G1/4	43.5	24	4.5
DLP-320-...-A	72	332	40	M10	M16	140	324	102	-	M5	378	G1/4	43.5	24	4.5

∅ [mm]	KK	L1	L3	L4	L5	L6	L7	T1	T2	T3	W1	WH	ZB	⊕1
DLP-80-...-A	M16x1.5	100 +1.4/-0.4	-	-	32	-	-	15	-	8	45°	16 +0.6/-1.8	116 +0.6/-0.8	16
DLP-100-...-A	M16x1.5	104 +1.4/-0.4	-	-	32	-	-	15	-	8	45°	16 +0.6/-1.8	120 +0.6/-0.8	16
DLP-125-...-A	M27x2	114 +1.6/-0.6	-	-	32	-	-	18	-	8	45°	24 +0.8/-1.8	138 +0.8/-1.0	27
DLP-160-...-A	M27x2	114 +1.6/-0.6	-	-	32	-	-	18	-	8	45°	24 +1.2/-1.8	138 +1.2/-0.8	27
DLP-200-...-A	M36x2	150 +0.8/-1.0	10	81	32	24.5	12	20	24	8	45°	30 ±1.4	180 ±1	36
DLP-250-...-A	M36x2	152 +0.8/-1.4	25	94	32	24.5	12	20	25	8	45°	30 +1.8/-1.4	182 ±1	36
DLP-320-...-A	M36x2	159 +0.8/-1.4	-	130	32	24.5	12	20	25	8	45°	30 +1.8/-1.6	189 +0.8/-1.2	36

Data sheet

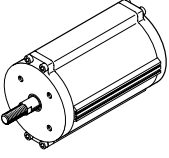
Ordering data				
Type	Piston diameter [mm]	Stroke [mm]	Part no.	Type
With position sensing				
	80	40 ... 500	187479	DLP-80-...-A
	100	50 ... 500	187480	DLP-100-...-A
	125	50 ... 500	187481	DLP-125-...-A
	160	100 ... 500	187482	DLP-160-...-A
	200	100 ... 600	542711	DLP-200-...-A
	250	100 ... 600	187483	DLP-250-...-A
	320	150 ... 600	187484	DLP-320-...-A



 **Note**

Generally, the stroke length of the linear actuator Copac corresponds to the nominal diameter of the process valve. The system tolerances can lead to a greater stroke range than the specified nominal stroke range of the linear actuator. The zero point is set with an adjustable rod clevis. This ensures that the end position of the valve slide is reached and the zero position of the system is fixed.



Additional stroke lengths on request.

Accessories



Ordering data – Piston rod attachments

Designation	For diameter	Part no.	Type
Rod eye SGS			
	80, 100	9263	SGS-M16x1.5
	125, 160	10774	SGS-M27x2
	200, 250, 320	10775	SGS-M36x2
Rod clevis SGA			
	80, 100	10768	SGA-M16x1.5
	125, 160	10770	SGA-M27x2
	200, 250, 320	10771	SGA-M36x2

Data sheets → Internet: piston rod attachment

Designation	For diameter	Part no.	Type
Rod clevis SG			
	80, 100	6146	SG-M16x1.5
	125, 160	14987	SG-M27x2-B
	200, 250, 320	9581	SG-M36x2
Self-aligning rod coupler FK			
	80, 100	6142	FK-M16x1.5
	125, 160	10485	FK-M27x2
	200, 250, 320	10746	FK-M36x2

Ordering data – Piston rod attachments, corrosion-resistant

Designation	For diameter	Part no.	Type
Rod eye CRSG			
	80, 100	13571	CRSG-M16x1.5
	125, 160	185361	CRSG-M27x2
Self-aligning rod coupler CRFK			
	80	2490673	CRFK-M16x1.5
	100		

Data sheets → Internet: piston rod attachment

Designation	For diameter	Part no.	Type
Rod clevis CRSGS			
	80, 100	195584	CRSGS-M16x1.5
	125, 160	195586	CRSGS-M27x2

Ordering data – Displacement encoder

Stroke [mm]	Part no.	Type
100	192213	MLO-POT-100-LWG
150	192214	MLO-POT-150-LWG
225	152645	MLO-POT-225-LWG
300	152646	MLO-POT-300-LWG
360	152647	MLO-POT-360-LWG
450	152648	MLO-POT-450-LWG
600	152650	MLO-POT-600-LWG
750	152651	MLO-POT-750-LWG

Data sheets → Internet: mlo

Ordering data – Plug socket for displacement encoder

PIN	Pin allocation	Part no.	Type
1	Power supply	194332	SD-4-WD-7
2	Signal		
3	0 V		
4	PE (yellow), shielded		

Data sheets → Internet: sd-4

Accessories







Ordering data – Proximity switch for T-slot, corrosion-resistant					Data sheets → Internet: crsmt
Switching output	Electrical connection	Cable length [m]	Part no.	Type	

N/O contact					
	PNP	Cable, 3-wire	5	574380	CRSMT-8M-PS-24V-K-5.0-OE

Ordering data – Proximity switch for T-slot, NAMUR					Data sheets → Internet: sdbt
Switching output	Electrical connection	Cable length [m]	Part no.	Type	

N/O contact					
	NAMUR	Cable, 2-wire	5	579071	SDBT-MS-20NL-ZN-E-5-LE-EX6
			10	579072	SDBT-MS-20NL-ZN-E-10-LE-EX6

Accessories

Ordering data – Connecting cable M8x1						Data sheets → Internet: nebu
	Electrical connection, left	Electrical connection, right	Switching output	Cable length [m]	Part no.	Type
Basic type						
	Straight socket, M8x1, 3-pin	Cable, open end, 3-wire	–	2.5	541333	NEBU-M8G3-K-2.5-LE3
				5	541334	NEBU-M8G3-K-5-LE3
				10	541332	NEBU-M8G3-K-10-LE3
	Angled socket, M8x1, 3-pin	Cable, open end, 3-wire	–	2.5	541338	NEBU-M8W3-K-2.5-LE3
				5	541341	NEBU-M8W3-K-5-LE3
				10	541335	NEBU-M8W3-K-10-LE3
With switching status indication						
	Angled socket, M8x1, 3-pin	Cable, open end, 3-wire	PNP	2.5	541337	NEBU-M8W5P-K-2.5-LE3
				5	541340	NEBU-M8W5P-K-5-LE3
			NPN	2.5	541336	NEBU-M8W5N-K-2.5-LE3
				5	541339	NEBU-M8W5N-K-5-LE3
Ordering data – Slot cover for T-slot						
	Mounting	Length [m]		Part no.	Type	
	Insertable	2x 0.5		151680	ABP-5-S	
Ordering data – Cable clip SMBK-8						
				Part no.	Type	
	For fixing the cable in the sensor slot			534254	SMBK-8	
Ordering data – Inscription labels						
	Material	Use	Dimensions [mm]	Part no.	Type	PU ¹⁾
	Polycarbonate	For insertion in the inscription label holder	23x4	541598	ASLR-L-423	34

1) Packaging unit per frame