

Linear actuators DFPC

FESTO



Key features

Function

The linear actuators DFPC are double-acting pneumatic actuators that are optimised for the requirements of process automation. The product variants with a mounting interface based on ISO 5210 or ISO 15552 and extended tie rods are designed for actuating process valves such as gate valves and knife-gate valves, pinch valves or process valves without housing. The sturdy, corrosion-resistant design is suitable for applications in different segments of process automation, such as water treatment, mining, the paper and pulp industry or the chemical

industry. The modular product system offers great flexibility thanks to the custom configuration options.

A number of standard variants can be supplied quickly from stock.

Innovative

- Sturdy, corrosion-resistant tie rod design, ideal for use in harsh ambient conditions
- Elastic cushioning rings for reducing the impact forces of the piston hitting the end positions of the actuator

Flexible

- Variants can be configured according to individual needs using a modular product system
- Standard variants available quickly from stock
- Additional contactless end-position sensing possible with proximity switches

Design

- Sturdy tie rod design
- Double-acting
- Sizes $\varnothing 80 \dots \varnothing 320$
- Stroke lengths 10 ... 1600 mm
- Mounting interface based on ISO 5210 or ISO 15552, with extended tie rods
- Operating pressure 0.06 ... 0.8 MPa, 8.7 ... 116 psi, 0.6 ... 8 bar
- Ambient temperature $-20 \dots +80^{\circ}\text{C}$
- ATEX II 2GD

Ordering data – Product options

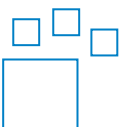

Configurable product
This product and all its product options can be ordered using the configurator.

The configurator can be found under Products on the DVD or at www.festo.com/catalogue/...

Part no.	Type
8110796	DFPC-80
8110785	DFPC-100
8110797	DFPC-125
8133065	DFPC-160
8133072	DFPC-200
8141420	DFPC-250
8141421	DFPC-320

Type codes

001	Series	
DFPC	Linear drive	

002	Piston diameter [mm]	
80	80	
100	100	
125	125	
160	160	
200	200	
250	250	
320	320	

003	Stroke [mm]	
50	50	
65	65	
80	80	
100	100	
125	125	
150	150	
200	200	
250	250	
300	300	
350	350	
400	400	
...	10 ... 1600	

004	Function	
D	Double-acting	

005	Piston rod thread type	
	Male thread	

006	Housing surface treatment	
	None	

007	EU certification	
	None	
EX4	II 2GD	

008	Piston rod extension	
	None	
...E	1 ... 500 mm	

009	Piston rod thread extension	
	None	
...L	0 ... 70 mm	

010	Piston rod thread shortening	
...S	1 ... 74 mm	

011	Piston rod thread	
	Standard	
M16	M16	
M16P	M16x1.5	
M20	M20	
M20P	M20x1.5	
M24	M24	
M24P	M24x2	
M27	M27	
M27P	M27x2	
M30	M30	
M30P	M30x2	
M36	M36	
M36P	M36x2	
M42	M42	
M42P	M42x2	
M48	M48	
M48P	M48x2	

012	Thread length of spacer bolts on bearing cap	
	None	
...LB2	10 ... 140 mm	

Peripherals overview

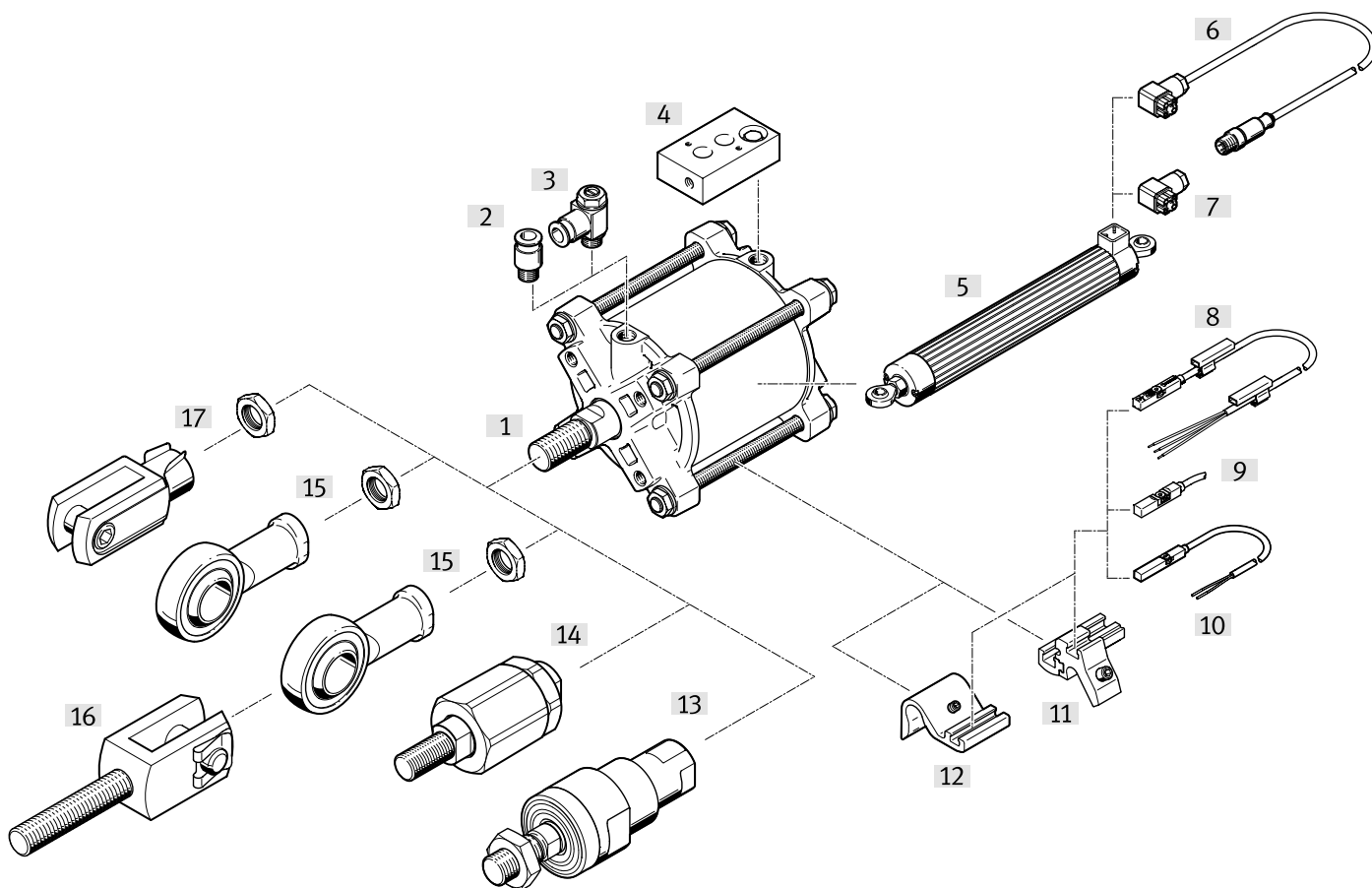





Mounting attachments and accessories		Description	→ Page/Internet
[1]	Linear actuators DFPC	Variants with mounting interface to ISO 5210 or ISO 15552 with extended tie rods	5
[2]	Push-in fitting QS	For connecting tubing with standard O.D.	qs
[3]	One-way flow control valve GRLA, GRLZ	Exhaust air and supply air flow control with one-way function	14
[4]	Control plate DADG	Control plate for mounting a valve to VDI/VDE 3845 (NAMUR) using a hollow bolt on the actuators of the DFPC series in sizes G1/8 and G1/4	14
[5]	Displacement encoder MLO-POT	Connecting rod potentiometer ¹⁾ , absolute measurement with high resolution	13
[6]	Connecting cable NEBC	M12, 5-pin connecting cable between the sensor interface and displacement encoder	15
[7]	Socket SD	For displacement encoder connection	15
[8]	Proximity switch CRSMT-8	Magneto-resistive, corrosion-resistant, to EU Explosion Protection Directive (ATEX)	14
[9]	Proximity switch SDBT	Magneto-resistive, NAMUR, to EU Explosion Protection Directive (ATEX)	14
[10]	Proximity switch SMT-8M-A	Magneto-resistive, 5 ... 30 V DC, to EU Explosion Protection Directive (ATEX)	14
[11]	Mounting kit SMBZ-8- ...	For proximity switch SME/SMT-8M, with piston diameter 100	15
[12]	Sensor bracket DASP-F10-...	For proximity switch SME/SMT-8M, for piston diameter 125 and piston diameter 160	15
[13]	Self-aligning rod coupler CRFK	For compensating radial and angular deviations, corrosion-resistant	13
[14]	Self-aligning rod coupler FK	For compensating radial and angular deviations	13
[15]	Rod eye SGS/CRSGS	With spherical bearing	13
[16]	Rod clevis SG/CRSG	Permits a swivelling movement of the cylinder in one plane	13
[17]	Rod clevis SGA	With male thread	13

1) The mounting on the linear actuator DFPC must be individually manufactured.

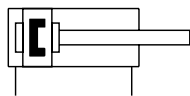
Datasheet

Function



-  - Piston \varnothing
80 ... 320 mm
-  - Stroke
10 ... 1600 mm
-  - Force
2827 ... 48255 N



General technical data

Size of valve actuator	80	100	125	160	200	250	320
Piston \varnothing	80 mm	100 mm	125 mm	160 mm	200 mm	250 mm	320 mm
Stroke	50 mm; 65 mm; 80 mm	80 mm; 100 mm; 125 mm	100 mm; 125 mm; 150 mm	150 mm; 200 mm; 250 mm; 300 mm	300 mm; 350 mm; 400 mm	-	
	10 ... 1600 mm						
Design	Piston, piston rod, tie rod, cylinder barrel						
Operating mode	Double-acting						
Pneumatic connection	G1/8			G1/4			
Cushioning	Elastic cushioning rings/plates at both ends						
Process valve connection to standard	ISO 5210						
Type of mounting	Optionally: on flange to ISO 5210, with spacer bolts						
Flange hole pattern	F07		F10			F10, F14	
Mounting position	Any						
Position sensing	For proximity switch						

1) Spacer bolts suitable for DFPC...LB2, based on ISO 15552

Operating and environmental conditions

Size of valve actuator	80	100	125	160	200	250	320
Operating medium	Compressed air to ISO 8573-1:2010 [7:4:4]						
Note on the operating/pilot medium	Lubricated operation possible (in which case lubricated operation will always be required)						
Operating pressure	0.06 ... 0.8 MPa						
Operating pressure	8.7 ... 116 psi						
Operating pressure	0.6 ... 8 bar						
Nominal operating pressure	0.6 MPa						
Ambient temperature	-20 ... 80°C						
Shock resistance ¹⁾	Shock test with severity level 1 to FN 942017-5 and EN 60068-2-27						
Vibration resistance ¹⁾	Transport application test with severity level 1 to FN 942017-4 and EN 60068-2-6						
Explosion protection certification outside the EU	-					EPL Db (GB), EPL Gb (GB)	

1) Effective up to a stroke of 400 mm

Datasheet

ATEX¹⁾

ATEX category gas	II 2G
Type of (ignition) protection for gas	Ex h IIC T4 Gb
ATEX category for dust	II 2D
Type of (ignition) protection for dust	Ex h IIIC T120°C Db
Explosion-proof ambient temperature	-20°C ≤ Ta ≤ +80°C
CE marking (see declaration of conformity)	To EU Explosion Protection Directive (ATEX)

1) Selected types, additional information at [www.festo.com/catalogue/...](http://www.festo.com/catalogue/)

Forces and impact energy

Size of valve actuator	80	100	125	160	200	250	320
Theoretical force at 0.6 MPa (6 bar, 87 psi), advancing	3016 N	4712 N	7363 N	12064 N	18850 N	29452 N	48255 N
Theoretical force at 0.6 MPa (6 bar, 87 psi), retracting	2827 N	4524 N	7069 N	11581 N	18096 N	28698 N	47077 N
Impact energy in the end positions	1.4 J	0.94 J	1.1 J	3.3 J	4.8 J	6 J	12.6 J

Permissible impact velocity:

Maximum permissible mass:

$$v = \sqrt{\frac{2 \cdot E}{m_1 + m_2}}$$

$$m_2 = \frac{2 \cdot E}{v^2} - m_1$$

v Impact velocity [m/s]
 E Kinetic impact energy [Nm]
 m₁ Moving dead weight [kg]
 m₂ Moving applied load [kg]

Air consumption¹⁾

Size of valve actuator	80	100	125	160	200	250	320
Air consumption, advancing, per 10 mm stroke	0.352 l	0.55 l	0.859 l	1.407 l	2.199 l	3.436 l	5.63 l
Air consumption, retracting, per 10 mm stroke	0.33 l	0.528 l	0.825 l	1.351 l	2.111 l	3.348 l	5.492 l

1) At 6 bar

Weight

Size of valve actuator	80	100	125	160	200	250	320
Basic weight with 0 mm stroke	1230.3 g	1666.6 g	2968.9 g	5948.7 g	10258.2 g	19296.54 g	33831.25 g
Additional weight per 10 mm stroke	61.8 g	71.4 g	107.4 g	148.61 g	255.79 g	335.51 g	473.67 g
Moving mass with 0 mm stroke	451 g	617.1 g	1059.6 g	2102 g	3575.4 g	5600.4 g	9868.9 g
Additional moving mass per 10 mm stroke	24.8 g		38.9 g	64.34 g	105.31 g		151.1 g

Datasheet

Materials

Cover material	Gravity die-cast aluminium, aluminium
Piston rod material	High-alloy stainless steel
Piston rod wiper seal material	TPE-U(PU)
Nut material	High-alloy stainless steel
Static seal material	NBR
Tie rod material	High-alloy stainless steel
Cylinder barrel material	Smooth-anodised wrought aluminium alloy
Note on materials	RoHS-compliant

Permissible axial force without buckling of the piston rod

The length "l" is made up of:

- The stroke of the actuator
- The piston rod extension
- The piston rod thread extension

The dimension "WH" and the thread length have already been taken into account.

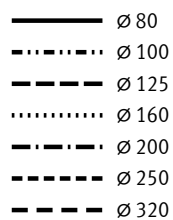
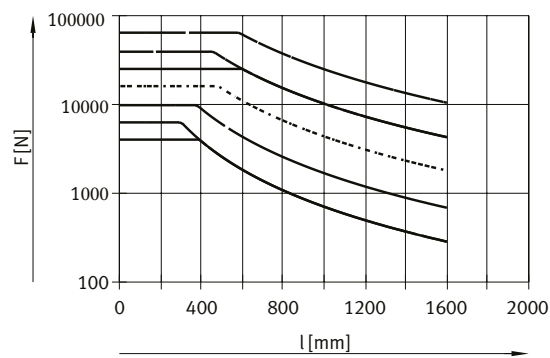

Datasheet

Dimensions

Download CAD data → www.festo.com

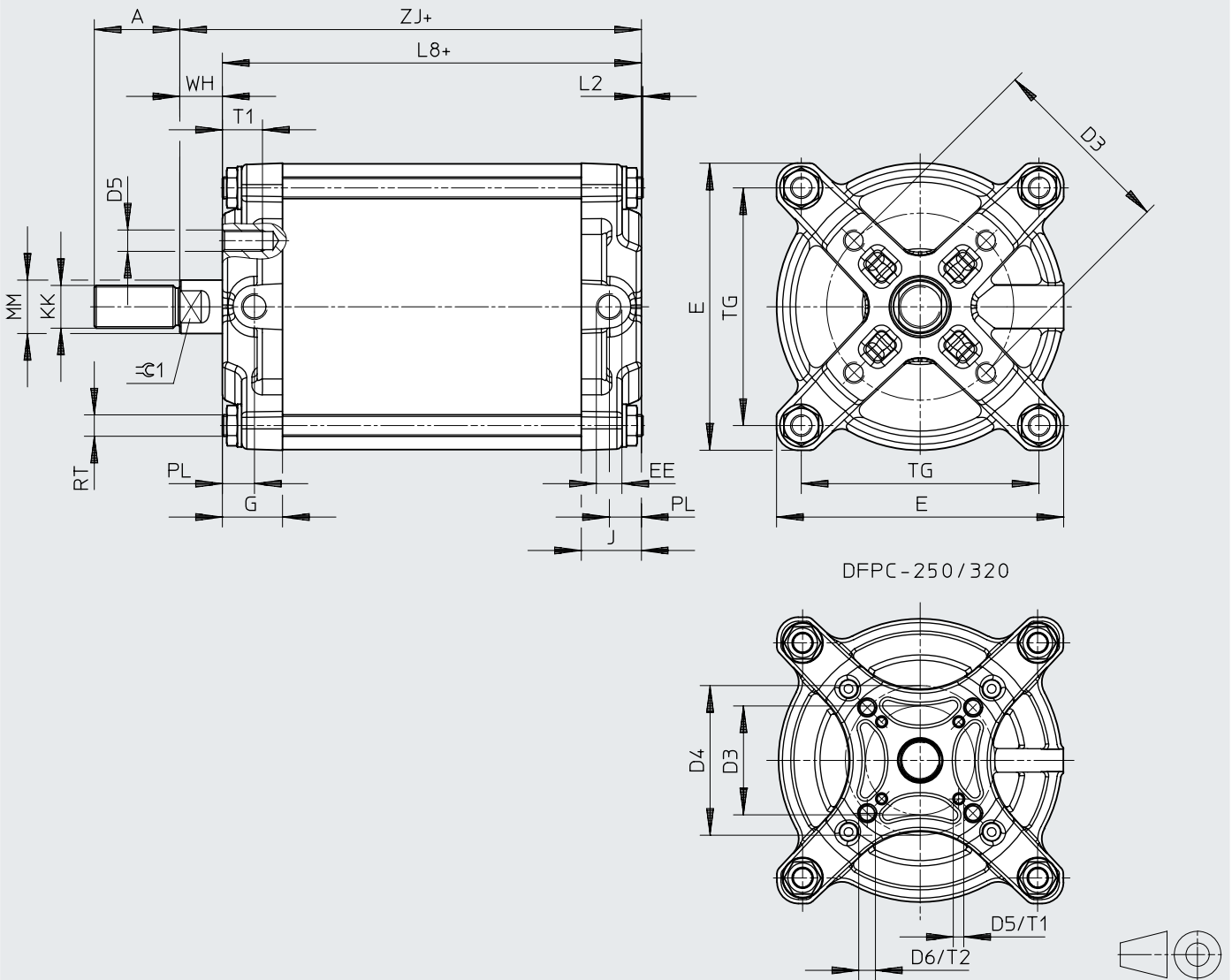

DFPC-250/320

+ = plus stroke length

Datasheet

	A	D3 ∅	D5	E	EE	G	J	L2
	-0.5							max.
DFPC-80-...-D	32	70	M8	90	G1/8	22.7	22.7	2.4
DFPC-100-...-D	32	70	M8	107.5	G1/8	22.5	22.5	2.2
DFPC-125-...-D	40	102	M10	136	G1/8	24.5	24.5	1.6
DFPC-160-...-D	54	102	M10	170	G1/4	25.3	25.3	0.7
DFPC-200-...-D	72	102	M10	211	G1/4	29.9	29.9	1
DFPC-250-...-D	72	102	M10	268	G1/4	39.2	39.2	2.5
DFPC-320-...-D	84	102	M10	338	G1/4	51	51	1.7

	L8	MM ∅	PL	RT	T1	TG	WH	ZJ	⊖1
DFPC-80-...-D	75.2	20	15.2	M8	15	72	16 +0.6/-1.6	91.2	16
DFPC-100-...-D	76.8	20	12	M8	15	89	16 +0.7/-1.2	92.8	16
DFPC-125-...-D	91	25	14	M10	18	110	20 +0.9/-1	111	21
DFPC-160-...-D	127	32	14.3	M12	18	140	24 +1.1/-1.1	150.9	27
DFPC-200-...-D	144.2	40	18.9	M16	20	175	30 +1.2/-1.2	173.8	36
DFPC-250-...-D	173.8	40	20.8	M20	20	220	30 +1.4/-1.4	203.8	36
DFPC-320-...-D	204.8	50	32	M20	20	270	30 +1.5/-1.5	234.8	46

	KK	
	DFPC...	-M-... ¹⁾
80	M16x1.5	M16/M20 ²⁾ /M20x1.5 ²⁾
100	M16x1.5	M16/M20 ²⁾ /M20x1.5 ²⁾
125	M20x1.5	M16/M16x1.5/M20/M24 ²⁾ /M24x1.5 ²⁾
160	M27x2	M16/M16x1.5/M20/M20x1.5/M24/M24x1.5/M27
200	M36x2	M16/M16x1.5/M20/M20x1.5/M24/M24x1.5/M27/M27x2/M30/M30x2/M36
250	M36x2	M24/M24x1.5/M27/M27x2/M30/M30x2/M36
320	M42x2	M27/M27x2/M30/M30x2/M36/M36x2/M42/M48/M48x2

- 1) Regular threads or threads with smaller nominal diameter than in the basic version can generally not withstand such high loads. This requires modifying the screw connection.
2) Additional lock nut for piston rod attachments (see page → 13) required for mounting.

Datasheet

Dimensions – Variants

Download CAD data → www.festo.com

[E] Extended piston rod

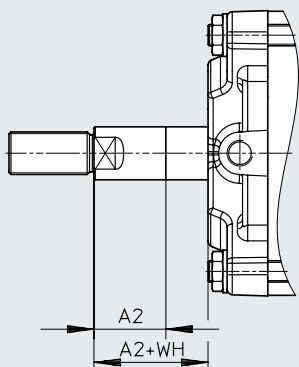

[S] Shortened piston rod thread

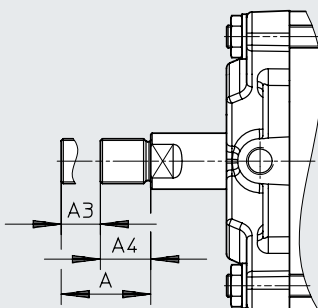

[L] Extended piston rod thread

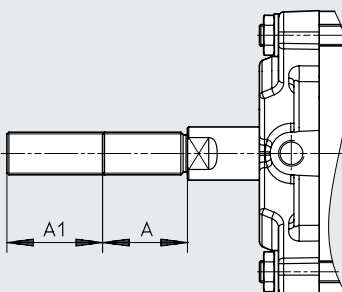

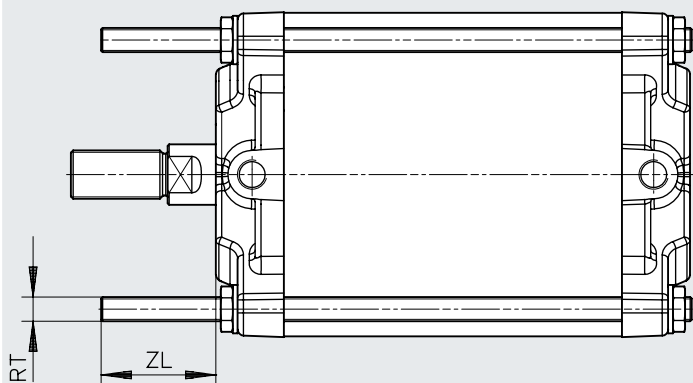

[LB2] Spacer bolts on the bearing cap

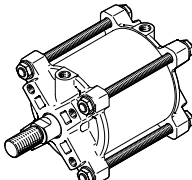

	A -0.5	A1		A2		A3		A4	RT	WH	ZL	
		min.	max.	min.	max.	min.	max.				min. ±0.5	max. ±0.5
DFPC-80-...-D	32	1	70	1	500	1	22	A – A3	M8	16 +0.6/-1.6	10	120
DFPC-100-...-D	32	1	70	1	500	1	22	A – A3	M8	16 +0.7/-1.2	10	120
DFPC-125-...-D	40	1	70	1	500	1	30	A – A3	M10	20 +0.9/-1	10	120
DFPC-160-...-D	54	1	70	1	500	1	44	A – A3	M12	24 +1.1/-1.1	10	120
DFPC-200-...-D	72	1	70	1	500	1	62	A – A3	M16	30 +1.2/-1.2	10	120
DFPC-250-...-D	72	1	70	1	500	1	62	A – A3	M20	30 +1.4/-1.4	10	140
DFPC-320-...-D	84	1	70	1	500	1	74	A – A3	M20	30 +1.5/-1.5	10	140

Datasheet

Ordering data		Piston ø [mm]	Stroke [mm]	Weight [g]	Part no.	Type
	Double-acting linear actuator with cushioning at both ends	80	50	1540	8110815	DFPC-80-50-D
			65	1720	8110817	DFPC-80-65-D
			80	1630	8110816	DFPC-80-80-D
		100	80	2240	8110777	DFPC-100-80-D
			100	2380	8110776	DFPC-100-100-D
			125	2560	8110775	DFPC-100-125-D
		125	100	4040	8110773	DFPC-125-100-D
			125	4310	8110774	DFPC-125-125-D
			150	4580	8110772	DFPC-125-150-D
		160	150	8180	8133079	DFPC-160-150-D
			200	8920	8133080	DFPC-160-200-D
			250	9660	8133081	DFPC-160-250-D
			300	10410	8133082	DFPC-160-300-D
		200	300	17930	8133104	DFPC-200-300-D
			350	19210	8133105	DFPC-200-350-D
400	20490		8133106	DFPC-200-400-D		

 **Note**

For other stroke variants in the modular product system, see page → 12

Ordering data – Modular product system

Ordering table												
Piston ø	80	100	125	160	200	250	320	Condi- tions	Code	Enter code		
Module no.	8110796	8110785	8110797	8133065	8133072	8141420	8141421					
Product type	DFPC								DFPC	DFPC		
Piston ø [mm]	80	–								–80		
	–	100	–							–100		
	–		125	–						–125		
	–			160	–					–160		
	–				200	–				–200		
	–					250	–			–250		
	–						320	–		–320		
Stroke [mm]	10 ... 1600											
Function	Double-acting								–D			
Piston rod thread type	Male thread											
Housing surface treatment	None											
EU certification	None									–EX4		
Piston rod extension [mm]	None											
	1 ... 500							[4]		–...E		
Piston rod thread extension [mm]	None											
	1 ... 70							[1]		–...L		
Piston rod thread shortener [mm]	None											
	1 ... 22	1 ... 22	1 ... 30	1 ... 44	1 ... 62	1 ... 62	1 ... 74	[2]		...S		
Piston rod thread	Standard (→ 9)											
	M16					–					–M16	
	–			M16x1.5		–					–M16P	
	M20										–M20	
	M20x1.5		–			M20x1.5		–			–M20P	
	–			M24				–		[3]	–M24	
	–			M24x1.5				–		[3]	–M24P	
	–				M27							–M27
	–					M27x2						–M27P
	–				M30							–M30
	–				M30x2							–M30P
	–					M36						–M36
	–						M36x2					–M36P
	–						M42					–M42
	–						M48					–M48
–						M48x2					–M48P	
Thread length of spacer bolts on the bearing cap [mm]	Without spacer bolts											
	10 ... 120					10 ... 140					...LB2	

- 1) ...L Not in combination with shortened piston rod thread (...S)
- 2) ...S Not in combination with extended piston rod thread (...L)
- 3) M24, M24P Not in combination with piston diameter 80 and 100
- 4) ...E Upper limit for selected stroke and piston rod extension is < 1600 mm

 **Note**

For other fixed-stroke variants,
see page → 11

Accessories

Ordering data – Piston rod attachments

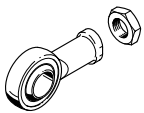
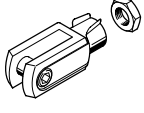
Designation	For ø	Part no.	Type
Rod eye SGS			
	80, 100	9263	SGS-M16x1.5
	125	9264	SGS-M20x1.5
	160	10774	SGS-M27X2
	200, 250	10775	SGS-M36X2
	320	10776	SGS-M42X2
Rod clevis SG¹⁾			
	80, 100	6146	SG-M16x1.5
	125	6147	SG-M20x1.5
	160	14987	SG-M27X2-B
	200, 250	9581	SG-M36X2
	320	9582	SG-M42X2

Datasheets → Internet: piston rod attachment

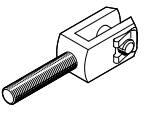
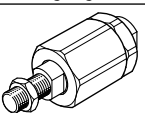
Designation	For ø	Part no.	Type
Rod clevis SGA¹⁾			
	80, 100	10768	SGA-M16x1.5
	125	10769	SGA-M20x1.5
	160	10770	SGA-M27X2
	200, 250	10771	SGA-M36X2
Self-aligning rod coupler FK¹⁾			
	80, 100	6142	FK-M16x1.5
	125	6143	FK-M20x1.5
	160	10485	FK-M27X2
	200, 250	10746	FK-M36X2

Ordering data – Piston rod attachments, corrosion-resistant

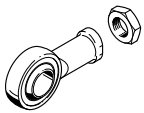
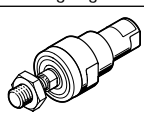
Designation	For ø	Part no.	Type
Rod eye CRSGS			
	80, 100	195584	CRSGS-M16x1.5
	125	195585	CRSGS-M20x1.5
	160	195586	CRSGS-M27X2
Self-aligning rod coupler CRFK			
	80, 100	2490673	CRFK-M16x1.5
	125	2545677	CRFK-M20x1.5

Datasheets → Internet: piston rod attachment

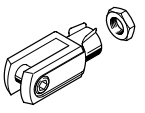
Designation	For ø	Part no.	Type
Rod clevis CRSG¹⁾			
	80, 100	13571	CRSG-M16x1.5
	125	13572	CRSG-M20x1.5
	160	185361	CRSG-M27X2





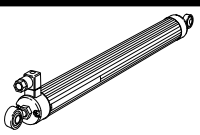

1) Suitable for ATEX (areas)

Ordering data – Displacement encoders





		Stroke [mm]	Part no.	Type
	Connecting rod potentiometer	100	192213	MLO-POT-100-LWG
		150	192214	MLO-POT-150-LWG
		225	152645	MLO-POT-225-LWG
		300	152646	MLO-POT-300-LWG
		360	152647	MLO-POT-360-LWG
		450	152648	MLO-POT-450-LWG
		600	152650	MLO-POT-600-LWG
		750	152651	MLO-POT-750-LWG

Datasheets → Internet: mlo-pot

Accessories

Ordering data – One-way flow control valves						
	Connection		Part no.	Type		
	Thread	For tubing O.D.				
Exhaust air flow control valve with slotted head screw						
	G1/8	4	193143	GRLA-1/8-QS-4-D		
		6	193144	GRLA-1/8-QS-6-D		
		8	193145	GRLA-1/8-QS-8-D		
Exhaust air flow control valve with knurled screw						
	G1/8	8	534337	GRLA-1/8-QS-8-RS-D		
Supply air flow control valve with slotted head screw						
	G1/8	8	193159	GRLZ-1/8-QS-8-D		
Ordering data – Control plate, NAMUR						
	Description	Pneumatic connection	Part no.	Type	Datasheets → Internet: dadg	
	For mounting a valve to VDI/VDE 3845 (NAMUR) using a hollow bolt	G1/4	8131548	DADG-FM-VDE1G14		
		G1/8	8131546	DADG-FM-VDE1G18		
Ordering data – Proximity switch for T-slot, magneto-resistive						
	Switching output	Electrical connection		Cable length [m]	Part no.	Type
		Cable	Plug M8x1			
N/O						
	PNP	–	3-pin	0.3	574334	SMT-8M-A-PS-24V-E-0.3-M8D
		3-core	–	5	574336	SMT-8M-A-PS-24V-E-5.0-OE
Ordering data – Proximity switch for T-slot, corrosion-resistant						
	Switching output	Electrical connection	Cable length [m]	Part no.	Type	Datasheets → Internet: crsmt
N/O						
	PNP	Cable, 3-core	5	574380	CRSMT-8M-PS-24V-K-5.0-OE	
Ordering data – Proximity switch for T-slot, NAMUR						
	Switching output	Electrical connection	Cable length [m]	Part no.	Type	Datasheets → Internet: sdbt
N/O						
	NAMUR	Cable, 2-core	5	579071	SDBT-MS-20NL-ZN-E-5-LE-EX6	
			10	579072	SDBT-MS-20NL-ZN-E-10-LE-EX6	

Accessories

Ordering data – Mounting kits for proximity switches			Datasheets → Internet: crsmb, smbz, dasp	
	For piston ø	Materials	Part no.	Type
	80 ... 320	Housing: Polyurethane Rail: Hard anodised aluminium Free of copper and PTFE	525565	CRSMB-8-32/100
	80, 100	Rail: Anodised wrought aluminium alloy Screws: High-alloy stainless steel Free of copper and PTFE	537806	SMBZ-8-32/100
	125	Housing: Anodised wrought aluminium alloy Screws: High-alloy stainless steel	8127664	DASP-F10-125-A
	160	Housing: Anodised wrought aluminium alloy Screws: High-alloy stainless steel	8144200	DASP-F10-160-A
	200	Housing: Anodised wrought aluminium alloy Screws: High-alloy stainless steel	1553813	DASP-M4-160-A
	250, 320		1456781	DASP-M4-250-A

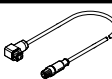
Ordering data – Connecting cables		Datasheets → Internet: nebc	
	Description	Part no.	Type
	Between sensor interface and displacement encoder	549293	NEBC-P1W4-K-0.3-N-M12G5

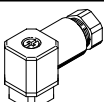
Ordering data – Plug sockets		Datasheets → Internet: sd	
	Description	Part no.	Type
	For displacement encoder connection	194332	SD-4-WD-7