

Safety systems CMGA



Safety systems CMGA

Key features

FESTO

At a glance

Safety systems (basic modules)

→ 9

- CMGA-B1-M0-L0-A0
- CMGA-B1-M1-L1-A0
- CMGA-B1-M2-L2-A0

The CMGA is a compact safety system with the option of integrated drive monitoring for one axis.

It can be parameterised using downloadable application programs (→ www.festo.com/net/Support-Portal). An ideal solution for simple applications.

The safety system can also be freely programmed for implementing complex applications.

Suitable for safe processing of:

- Emergency stop switches
- Door monitoring
- Light curtains
- Two-hand buttons
- Enabling buttons
- Limit switches
- Measuring systems

There are pre-configured modules available for pre-processing of safety-relevant signals. The same applies to safety functions for drive monitoring.

In its basic design, the device has 14 safe inputs and 3 switch-off channels, which can be extended to max. 65 safe I/Os.

There are modules with encoder interface (incl. TTL/HTL, SIN/COS, proximity switch) available for safe speed and/or position sensing.

Safety systems (extension modules)

→ 15

- CMGA-E1
- CMGA-E1-CO
- CMGA-E1-DN
- CMGA-E1-PB

Extension modules for I/O:

The extension module has:

- 12 safe inputs
- 10 safe inputs/outputs, can be configured as inputs or outputs
- 2 signal outputs.

Extension modules for fieldbus:

Extension modules for transmitting diagnostic and status data to a higher-level controller by means of a standard fieldbus.

A maximum of two extension modules can be operated with one basic module.

Mounting

The modules are mounted on a mounting rail by means of snap latches (→ 20).

The individual modules are connected using plug connectors NEKM 1 (→ 20), which are also attached to the mounting rail.

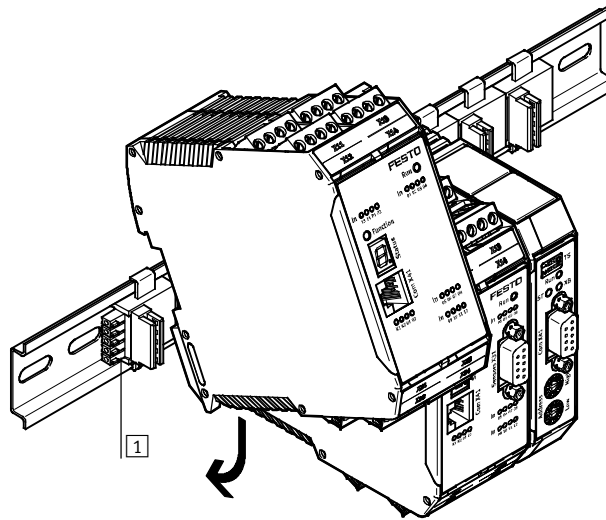

Safety systems CMGA

Key features

Overview of the safety system

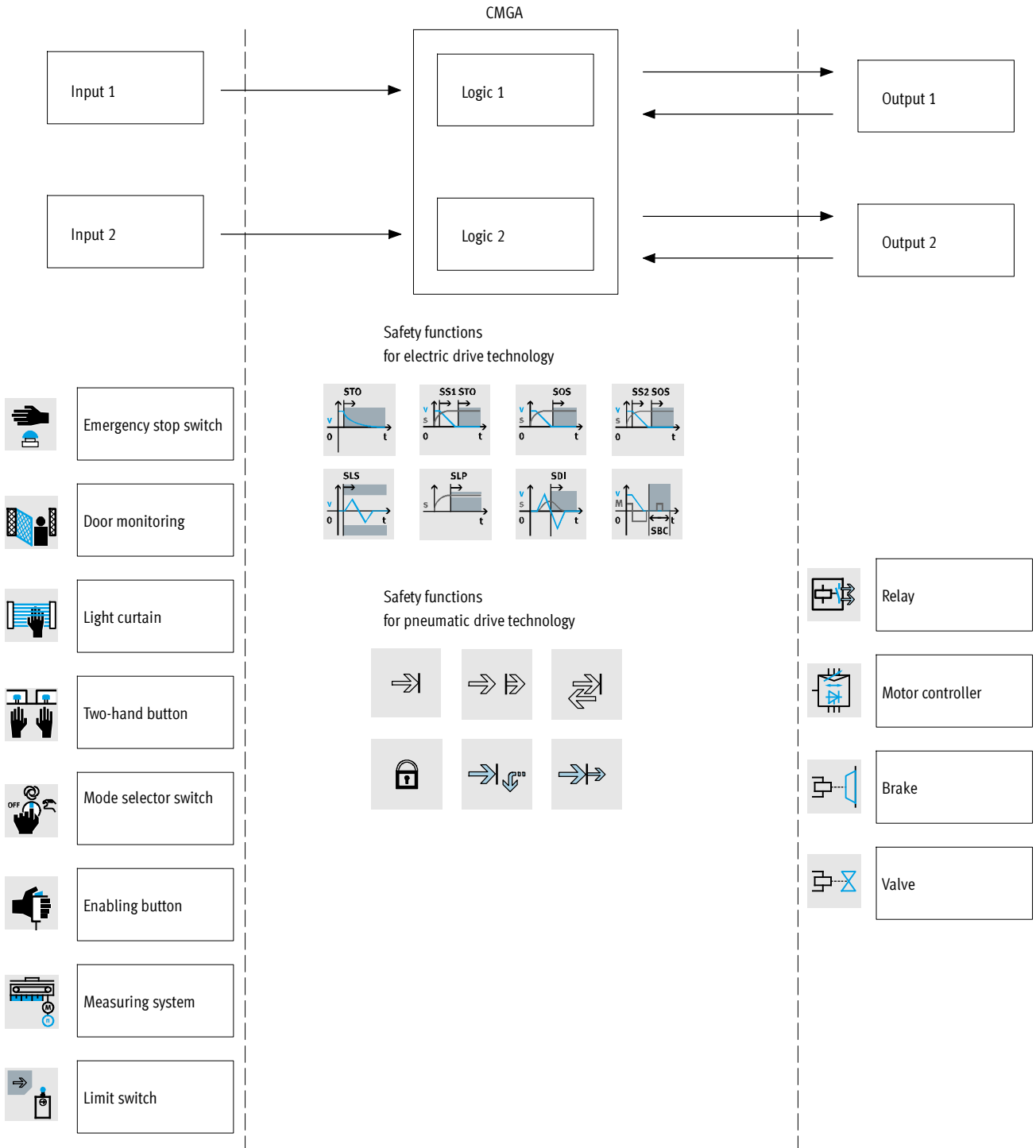

Safety systems CMGA

Key features

FESTO

Safety inputs

Emergency stop switch



- For manually requesting an emergency stop
- Single-channel input signal (1 N/C contact)
- Two-channel input signal (2 N/C contacts)
- Logic and optional time-based monitoring of the two-channel input signals
- Optional cross-circuit detection
- Optional acknowledgement request after start and activation

Door monitoring

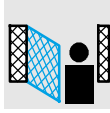

- Two-channel input signal (1 N/C contact and 1 N/O contact or 2 N/C contacts)
- Optional with single-channel or two-channel input signal for interlocking
- Logic and optional time-based monitoring of the two-channel input signals
- Optional cross-circuit detection
- Optional acknowledgement request after start and opening

Light curtain

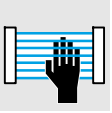

- Two-channel input signal (1 N/C contact and 1 N/O contact or 2 N/C contacts)
- Logic and optional time-based monitoring of the two-channel input signals
- Optional cross-circuit detection
- Optional acknowledgement request after start and activation

Two-hand button

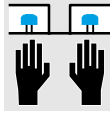

- Single-channel input signal (2 N/O contacts, type IIIA acc. to EN 574)
- Two-channel input signal (2 changeover switches, type IIIC acc. to EN 574)
- Logic and time-based monitoring of the two-channel input signals
- Cross-circuit detection

Limit switch



- Single-channel input signal (1 N/O contact or 1 N/C contact)
- Two-channel input signal (2 N/C contacts)
- Logic and optional time-based monitoring of the two-channel input signals
- Optional cross-circuit detection







Mode selector switch



- 2, 3 or 4 input signals
- Logic monitoring of the input signals
- Optional cross-circuit detection

Safety systems CMGA

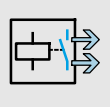
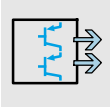
Key features

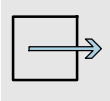
Safety inputs	
Enabling button  <ul style="list-style-type: none"> • Single-channel input signal (1 N/C contact or 1 N/O contact) • Two-channel input signal (2 N/C contacts) 	Pressure-sensitive safety mat with switching contact(s)  <ul style="list-style-type: none"> • Logic and optional time-based monitoring of the two-channel input signals • Optional cross-circuit detection • Optional acknowledgement request after start and monitoring
Scanner  <ul style="list-style-type: none"> • Single-channel input signal (1 N/O contact or 1 N/C contact) • Two-channel input signal (1 N/O contact and 1 N/C contact or 2 N/C contacts) 	Start button  <ul style="list-style-type: none"> • Logic and optional time-based monitoring of the two-channel input signals • Optional cross-circuit detection • Optional acknowledgement request after start and activation
Safe relay output  <p>Safe switch-off channel with two linked relay outputs. Externally connected contactors and relays with forced contacts can optionally be monitored.</p>	High/low semiconductor outputs  <p>Safe switch-off channel with two linked semiconductor outputs. Externally connected contactors and relays with forced contacts can optionally be monitored.</p>
Safe digital outputs  <p>Safe digital outputs with optional monitoring of externally connected contactors and relays.</p>	Signal outputs  <p>Non-safe signal outputs for messages to other logic devices, e.g. error messages to the higher-level controller.</p>

Safety systems CMGA

Key features

FESTO

Safety functions for electric drive technology

Safe Torque Off (STO)



Shuts off the supply of torque-generating energy to the drive to prevent movement.
Corresponds to stop category 0 to DIN EN 60204-1.

Safe Stop 1 (SS1, type 3)

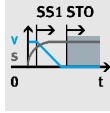

Triggers and controls the drive delay and triggers the safe torque off function with a delay
Corresponds to stop category 1 to DIN EN 60204-1.

Safe Stop 1 (SS1, type 1 or 2)

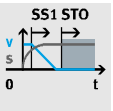

Triggers and monitors the drive delay and triggers the safe torque off function when the drive is at standstill.
Corresponds to stop category 1 to DIN EN 60204-1.

Safe Operating Stop (SOS, type 1)

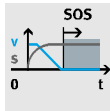

Prevents the active drive moving out of standstill at only minimal speed.

Safe Operating Stop (SOS, type 2)

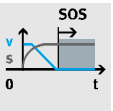

Prevents the active drive moving out of standstill by more than a specific amount.

Safe Stop 2 (SS2, type 3)

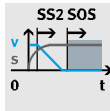

Triggers and controls the drive delay and triggers the safe operating stop function with a delay.
Corresponds to stop category 2 to DIN EN 60204-1.

Safe Stop 2 (SS2, type 1 or 2)

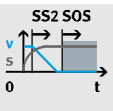

Triggers and monitors the drive delay and triggers the safe operating stop function at standstill.
Corresponds to stop category 2 to DIN EN 60204-1.

Safely Limited Speed (SLS)

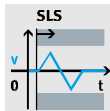

Prevents the motor exceeding the defined speed limit.

Safe Brake Control (SBC)

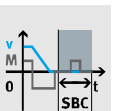

Supplies a safe output signal for activating external clamping units or brakes.

Safe Direction (SDI)

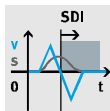

Prevents the drive moving in the wrong direction.

Safely Limited Position (SLP)

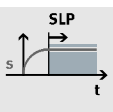

Prevents the drive exceeding the defined position or orientation limits.

Safe Cam (SCA)

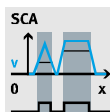

A safe output signal is generated while the motor position is in a specified range.

Safety systems CMGA

Key features

Safety functions for electric drive technology

Safe Speed Monitor (SSM)

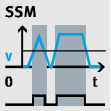

A safe output signal is generated while the speed is in a specified range.

Safely Limited Increment (SLI)



Monitors adherence to a specified increment during movements.

Encoder Status (ECS)

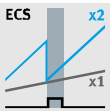

Error status of the speed/position sensor.

Position Deviation Muting (PDM)

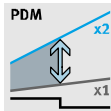

Mutes deviation monitoring during two-sensor operation.

Safety functions for pneumatic drive technology

The following safety functions for pneumatic drive technology can be activated and monitored together with a suitable pneumatic circuit.

The safety characteristics that can be achieved depend on the circuit and the components used.

Safe stopping and blocking



Stops a standard pneumatic drive by shutting off at least one volumetric flow path into or out of the drive.

Switching to unpowered

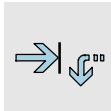

Shuts off the supply of energy to the pneumatic drive; both chambers are exhausted.

Safely limited speed

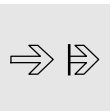

Prevents the pneumatic drive exceeding the defined speed limit.

Safely limited force/torque

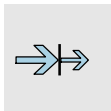

Prevents the pneumatic drive exceeding the defined force/torque limit.

Safe reversing



Reverses the direction of movement of the pneumatic drive and prevents the drive moving in the wrong direction.

Safe venting

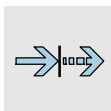

Supplies a limited amount of energy to the system or drive. This triggers the system or drive to move to the initial position.

Safety systems CMGA

Key features



Application programs

There are application programs available to download in the support portal (➔ www.festo.com/net/SupportPortal).

The programs are designed for one performance level (PLe), category 4; however, the actual levels and

categories depend on the components used and the wiring.

Functions	Safety system		Electric axes	Emergency stop	Protection against startup Acknowledgement and start button	Operating modes Automatic and manual	Output of ready for operation	Output of emergency stop request	Output of operating modes	Protective door	Light curtain	Two-hand	Manual: Enabling button	Special operating mode: Single-ended operation: Light curtain
	Number	Type												
Emergency stop switch, STO	1	CMGA-B1-M0-L0-A0	≥1	1 ... 3	1	–	1	1	–	–	–	–	–	–
Emergency stop switch, SS1	1	CMGA-B1-M0-L0-A0	≥1	1 ... 3	1	–	1	1	–	–	–	–	–	–
• Emergency stop switch • Safety doors • Manual operating mode	1	CMGA-B1-M0-L0-A0	≥1	1 ... 3	1	2	1	1	–	1 ... 3	–	–	–	–
	1 ... 2	CMGA-E1												
• Emergency stop switch • Safety doors • Manual operating mode: Enabling button with SLS	1	CMGA-B1-M2-L2-A0	1	1 ... 3	1	2	1	1	2	1 ... 3	–	–	1	–
	1 ... 2	CMGA-E1												
• Emergency stop switch • Safety doors • Light curtain • Manual operating mode: Enabling button with SLS	1	CMGA-B1-M2-L2-A0	1	1 ... 3	1	2	1	1	2	1 ... 3	1 ... 3	–	1	–
	1 ... 2	CMGA-E1												
• Emergency stop switch • Safety doors • Light curtain • Two-hand operation • Manual operating mode: Enabling button with SLS	1	CMGA-B1-M2-L2-A0	1	1 ... 3	1	2	1	1	2	1 ... 3	1 ... 3	1	1	–
	1 ... 2	CMGA-E1												
• Emergency stop switch • Safety doors • Two-hand operation • Manual operating mode: Enabling button with SLS	1	CMGA-B1-M2-L2-A0	1	1 ... 3	1	2	1	1	2	1 ... 3	–	1	1	–
	1 ... 2	CMGA-E1												
• Emergency stop switch • Safety doors • Light curtain • Light curtain in single- ended operation • Manual operating mode: Enabling button with SLS	1	CMGA-B1-M2-L2-A0	1	1 ... 3	1	3	1	1	3	1 ... 3	1 ¹⁾ 0 ... 2 ¹⁾	–	1	1
	1 ... 2	CMGA-E1												

1) 1 Light curtain in single-ended operation
0 ... 2 Light curtain triggers an emergency stop

Safety systems CMGA, basic module

Type codes

Safety system (basic module)

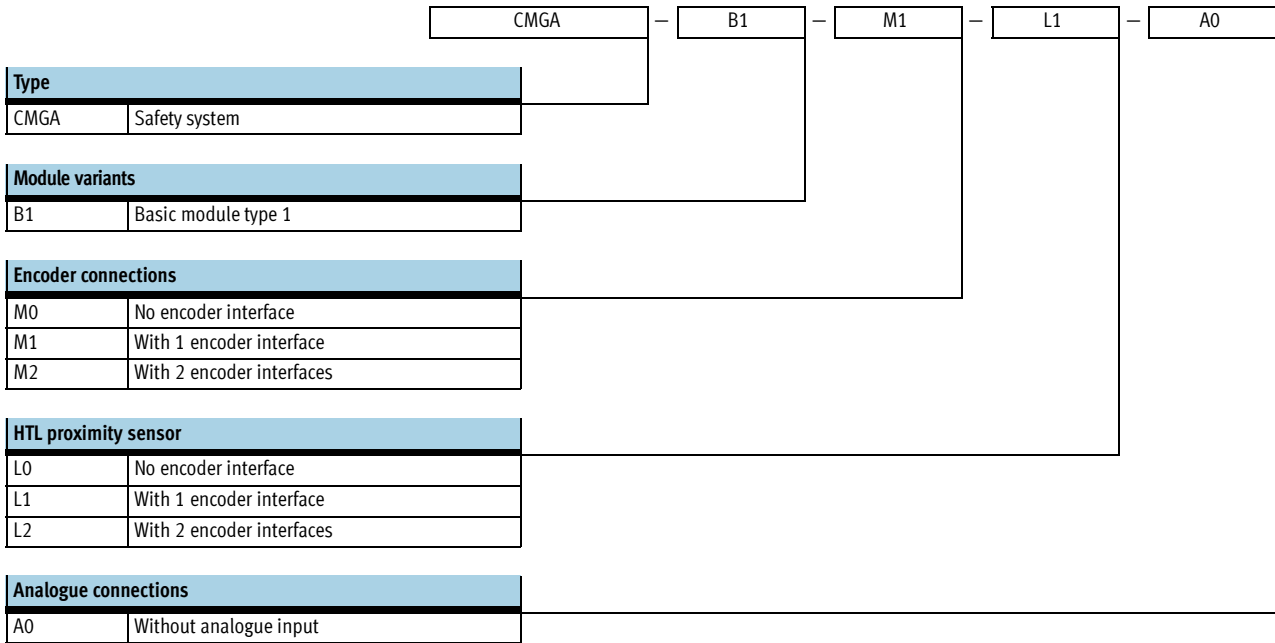

Safety systems CMGA, basic module

Technical data

FESTO

Safety system
CMGA-B1



Safety characteristics			
Type	CMGA-		
	B1-M0-L0-A0	B1-M1-L1-A0	B1-M2-L2-A0
Conforms to	EN ISO 13849-1		
Safety function	Safe Torque Off (STO)		
	Safe Brake Control (SBC)		
	Safe logic functions		
	Safe Stop 1 (SS1) type 3		
	-	Safe Stop 1 (SS1), type 1, 2	
	-	Safe Operating Stop (SOS)	
	-	Safe Stop 2 (SS2), type 1, 2, 3	
	-	Safely Limited Speed (SLS)	
	-	Safely Limited Position (SLP)	
	-	Safe Direction (SDI)	
	-	Safely Limited Increment (SLI)	
	-	Safely Limited Acceleration (SLA)	
	-	Safe Emergency Limit (SEL)	
	-	Safe Cam (SCA)	
-	Position Deviation Muting (PDM)		
-	Encoder Status (ECS)		
Performance level (PL)	Cat. 4, PL e		
Safety integrity level (SIL)	SIL 3		
Certificate issuing authority	TÜV Rheinland		
PFH	3.0×10^{-9}	2.2×10^{-9}	6.2×10^{-9}
Proof test interval	20 a		
CE marking (see declaration of conformity)	To EU EMC Directive ¹⁾		
	To EC Machinery Directive		
Shock resistance	As per EN 60068-2-29		
Vibration resistance	As per EN 60068-2-6		

1) For information about the applicability of the component see the manufacturer's EC declaration of conformity at: www.festo.com → Support → User documentation.
If the component is subject to restrictions on usage in residential, office or commercial environments or small businesses, further measures to reduce the emitted interference may be necessary.

Safety systems CMGA, basic module

Technical data

General technical data			
Type	CMGA-		
	B1-M0-L0-A0	B1-M1-L1-A0	B1-M2-L2-A0
Axis monitoring	–	1 axis	1 axis
Encoder interface input, function	–	1 input: incr. TTL (max. 200 kHz) incr. HTL (max. 200 kHz) sin/cos (max. 200 kHz) SSI (max. 150 kHz)	2 inputs: incr. TTL (max. 200 kHz) incr. HTL (max. 200 kHz) sin/cos (max. 200 kHz) SSI (max. 150 kHz)
	–	1 input: Proximity sensor (max. 10 kHz)	2 inputs: Proximity sensor (max. 10 kHz)
Number of digital logic inputs	14, including 8 OSSD-compatible (24 V DC/20 mA)		
Digital output design	1 safe relay output (24 V DC/2 A or 230 V AC/2 A)		
	2 signal outputs (24 V DC/100 mA)		
	2 pulse outputs (max. 250 mA)		
	2 safe digital outputs (24 V DC/250 mA)		
Electrical connection	Plug-in		
Connection cross section [mm]	0 ... 1.5		
Display	LED		
	Digit representation with 7 segments		
Mounting position	Free convection		
	Vertical		
Type of mounting	Via mounting rail		
Product weight [g]	300	310	390

Electrical data		
Nominal operating voltage [V DC]	24 (–15%/+20%)	
Nominal current, logic supply [A]	Max. 2	
Operating range of logic input [V DC]	24 (–15%/+20%)	
Logic input specification	Based on IEC 61131-2	
Safe digital outputs [mA]	250	
Signal outputs [mA]	100	

Operating and environmental conditions			
Type	CMGA-		
	B1-M0-L0-A0	B1-M1-L1-A0	B1-M2-L2-A0
Ambient temperature [°C]	0 ... 50		
Storage temperature [°C]	–10 ... +70		
Protection class	IP20		
CE marking (see declaration of conformity)	To EU EMC Directive ¹⁾		
	To EC Machinery Directive		
Note on materials	RoHS-compliant		
	Contains PWIS (paint-wetting impairment substances)		

1) For information about the applicability of the component see the manufacturer's EC declaration of conformity at: www.festo.com → Support → User documentation.
If the component is subject to restrictions on usage in residential, office or commercial environments or small businesses, further measures to reduce the emitted interference may be necessary.

Safety systems CMGA, basic module

Technical data



Pin allocation

CMGA-B1-M0-L0-A0

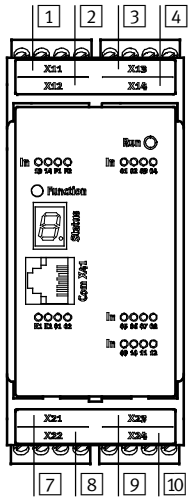

CMGA-B1-M1-L1-A0

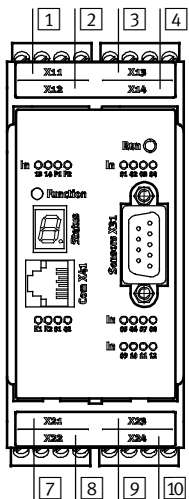

CMGA-B1-M2-L2-A0

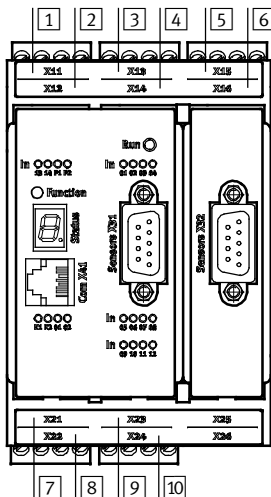

Plug	Pin	Function	Description	Note	
Safety characteristics					
1	X11	1	U24	Voltage supply	
	2	U24	Voltage supply		
	3	0 V	Voltage supply		
	4	0 V	Voltage supply		
2	X12	1	DI 13	Digital IN 13	
	2	DI 14	Digital IN 14		
	3	P1	Pulse output P1		
	4	P2	Pulse output P2		
3	X13	1	U_ENC_1	Supply to encoder X31 ¹⁾	
	2	GND_ENC_1	Supply to encoder X31 ¹⁾		
	3	DO 0.1	Signal and auxiliary output		
	4	DO 0.2	Signal and auxiliary output		
4	X14	1	DI 01	Digital IN 01 OSSD-compatible	PL e
	2	DI 02	Digital IN 02 OSSD-compatible	PL e	
	3	DI 03	Digital IN 03 OSSD-compatible	PL e	
	4	DI 04	Digital IN 04 OSSD-compatible	PL e	
5	X15	1	U_ENC_2	Supply to encoder X32 ²⁾	
	2	GND_ENC_2	Supply to encoder X32 ²⁾		
	3	n.c.	Do not use		
	4	n.c.	Do not use		
6	X16	1	n.c.	Do not use	
	2	n.c.	Do not use		
	3	n.c.	Do not use		
	4	n.c.	Do not use		
7	X21	1	DO 0 HI	HISIDE output 0	In combination with safe switch-off channel, category 4
	2	DO 0 LO	LOSIDE output 0		
	3	DO 1 HI	HISIDE output 1	In combination with safe switch-off channel, category 4	
	4	DO 1 LO	LOSIDE output 1		
8	X22	1	K1.1	Relay output 1	In combination with safe switch-off channel, category 4
	2	K1.2	Relay output 1		
	3	K2.1	Relay output 2		
	4	K2.2	Relay output 2		
9	X23	1	DI 05	Digital IN 05	PL d
	2	DI 06	Digital IN 06	PL d	
	3	DI 07	Digital IN 07	PL d	
	4	DI 08	Digital IN 08	PL d	
10	X24	1	DI 09	Digital IN 09 OSSD-compatible	PL e
	2	DI 10	Digital IN 10 OSSD-compatible	PL e	
	3	DI 11	Digital IN 11 OSSD-compatible	PL e	
	4	DI 12	Digital IN 12 OSSD-compatible	PL e	

1) Not used with CMGA-B1-M0-L0-A0.

2) Not used with CMGA-B1-M0-L0-A0 and CMGA-B1-M1-L1-A0.

Safety systems CMGA, basic module

Technical data

Pin allocation

CMGA-B1-M1-L1-A0

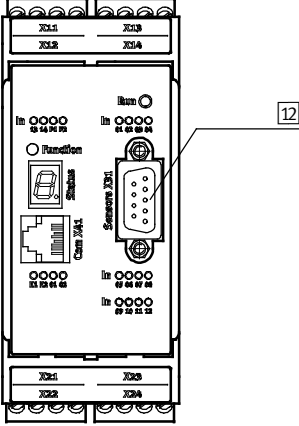

CMGA-B1-M2-L2-A0

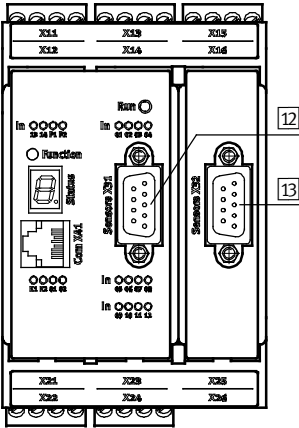

Plug	Pin	Incr. TTL	sin/cos	SSI Master mode	SSI Slave mode
12 X31	1	n.c.	n.c.	n.c.	n.c.
	2	0 V	0 V	0 V	0 V
	3	n.c.	n.c.	n.c.	n.c.
	4	B-	cos-	Clk-	Clk-
	5	A+	sin+	Data+	Data+
	6	A-	sin-	Data-	Data-
	7	n.c.	n.c.	n.c.	n.c.
	8	B+	cos+	Clk+	Clk+
	9	+V _{DC}	+V _{DC}	+V _{DC}	+V _{DC}
13 X32	1	n.c.	n.c.	n.c.	n.c.
	2	0 V	0 V	0 V	0 V
	3	n.c.	n.c.	n.c.	n.c.
	4	B-	cos-	Clk-	Clk-
	5	A+	sin+	Data+	Data+
	6	A-	sin-	Data-	Data-
	7	n.c.	n.c.	n.c.	n.c.
	8	B+	cos+	Clk+	Clk+
	9	+V _{DC}	+V _{DC}	+V _{DC}	+V _{DC}

Safety systems CMGA, basic module

Technical data

Dimensions Download CAD data → www.festo.com

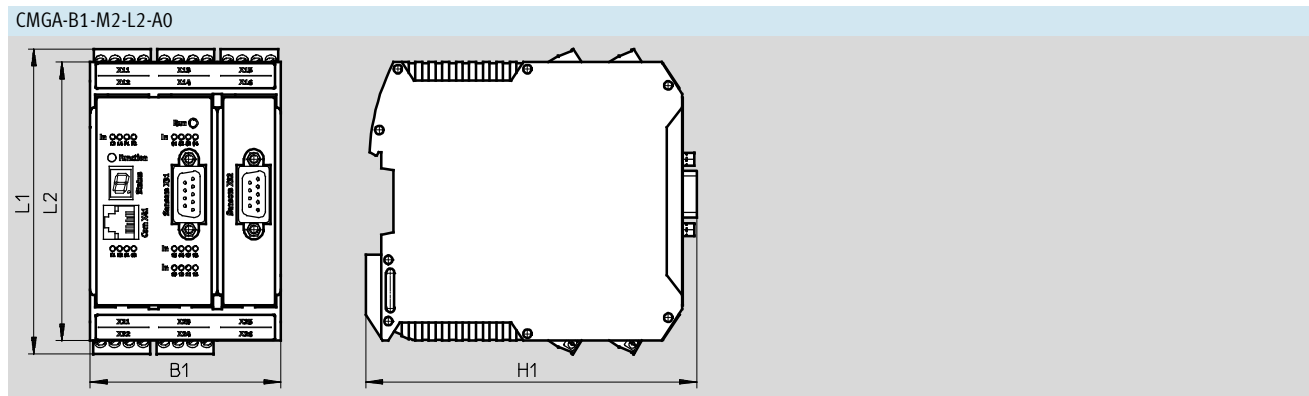
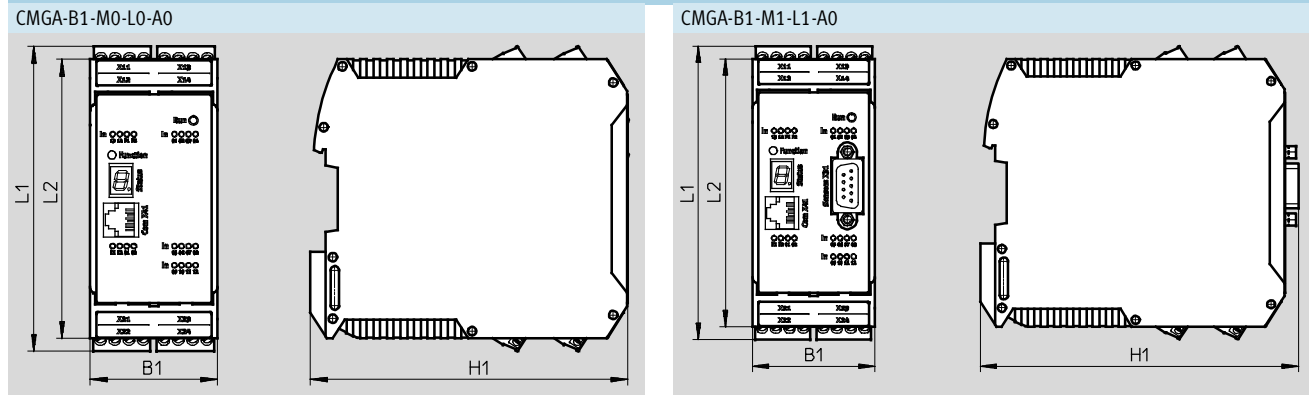

Type	B1	H1	L1	L2
CMGA-B1-M0-L0-A0	45	113	108	99
CMGA-B1-M1-L1-A0	45	118	108	99
CMGA-B1-M2-L2-A0	68	118	108	99

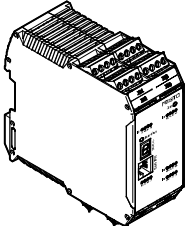
Ordering data			
Type	Description	Part No.	Type
	-	1680823	CMGA-B1-M0-L0-A0
	For 1 axis, 1 encoder input	1680824	CMGA-B1-M1-L1-A0
	For 1 axis, 2 encoder inputs	1680825	CMGA-B1-M2-L2-A0

Safety systems CMGA, extension module

Type codes

Safety system (extension module)

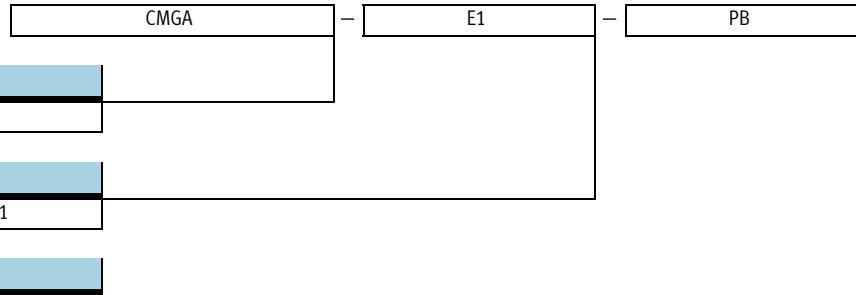

Type	
CMGA	Extension module

Module variants	
E1	Extension module for series CMGA-B1

Communication	
-	I/O
CO	CANopen
DN	DeviceNet
PB	Profibus DP

Safety systems CMGA, extension module

Technical data

FESTO

Safety system
CMGA-E1



Safety characteristics	
Type	CMGA-E1
Conforms to	EN ISO 13849-1
Performance level (PL)	Cat. 4, PL e
Safety integrity level (SIL)	SIL 3
Certificate issuing authority	TÜV Rheinland
PFH	2.6×10^{-9}
Proof test interval	20 a
CE marking (see declaration of conformity)	To EU EMC Directive ¹⁾ To EC Machinery Directive
Shock resistance	As per EN 60068-2-29
Vibration resistance	As per EN 60068-2-6

1) For information about the applicability of the component see the manufacturer's EC declaration of conformity at: www.festo.com → Support → User documentation.
If the component is subject to restrictions on usage in residential, office or commercial environments or small businesses, further measures to reduce the emitted interference may be necessary.

General technical data				
Type	CMGA-			
	E1	E1-CO	E1-DN	E1-PB
Number of digital logic inputs	12, including 8 OSSD-compatible	–	–	–
Digital output design	10 safe digital inputs/outputs	–	–	–
	2 signal outputs	–	–	–
	2 pulse outputs	–	–	–
Electrical connection	Plug-in	–	–	–
Connection cross section [mm]	0 ... 1.5	–	–	–
Display	LED	–	–	–
Control elements	–	DIP switch	–	–
	–	Rotary coding switch	–	–
Mounting position	Free convection	–	–	–
	Vertical	–	–	–
Type of mounting	Via mounting rail	–	–	–
Product weight [g]	300	110	110	110

Safety systems CMGA, extension module

Technical data

Technical data – Fieldbus interface				
Type	CMGA-			
	E1	E1-CO	E1-DN	E1-PB
Bus connection	–	9-pin, Sub-D	5-pin, Sub-D	9-pin, Sub-D
Fieldbus coupling	–	CANopen	DeviceNet	Profibus DP
Max. fieldbus transmission rate [Mbps]	–	1	0.5	12

Electrical data				
Type	CMGA-			
	E1	E1-CO	E1-DN	E1-PB
Nominal operating voltage [V DC]	24 (–15%/+20%)			
Nominal current, logic supply [A]	2	–	–	–
Operating range of logic input [V DC]	24 (–15%/+20%)			
Logic input specification	Based on IEC 61131-2			
Safe digital inputs/outputs [mA]	250	–	–	–
Signal outputs [mA]	100	–	–	–

Operating and environmental conditions				
Type	CMGA-			
	E1	E1-CO	E1-DN	E1-PB
Ambient temperature [°C]	0 ... 50			
Protection class	IP20			
CE marking (see declaration of conformity)	To EU EMC Directive ¹⁾			
	To EC Machinery Directive	–	–	–
Note on materials	RoHS-compliant			
	Contains PWIS (paint-wetting impairment substances)			

1) For information about the applicability of the component see the manufacturer's EC declaration of conformity at: www.festo.com → Support → User documentation.
 If the component is subject to restrictions on usage in residential, office or commercial environments or small businesses, further measures to reduce the emitted interference may be necessary.

Safety systems CMGA, extension module

Technical data

Pin allocation					
CMGA-E1					
Plug	Pin	Function	Description	Note	
				Safety characteristics	
1	X11	1	U24	Voltage supply	
		2	U24	Voltage supply	
		3	0 V	Voltage supply	
		4	0 V	Voltage supply	
2	X12	1	IO 01	Digital I/O 1	PL e, two channel with 2 pulses
		2	IO 02	Digital I/O 2	PL e, two channel with 2 pulses
		3	P1	Pulse output P1	
		4	P2	Pulse output P2	
3	X13	1	n.c.	Do not use	
		2	n.c.	Do not use	
		3	O 1.1	Signal and auxiliary output	
		4	O 1.2	Signal and auxiliary output	
4	X14	1	DI 01	Digital IN 01 OSSD-compatible	PL e
		2	DI 02	Digital IN 02 OSSD-compatible	PL e
		3	DI 03	Digital IN 03 OSSD-compatible	PL e
		4	DI 04	Digital IN 04 OSSD-compatible	PL e
5	X21	1	IO 03	Digital I/O 3	PL e, two channel with 2 pulses
		2	IO 04	Digital I/O 4	PL e, two channel with 2 pulses
		3	IO 05	Digital I/O 5	PL e, two channel with 2 pulses
		4	IO 06	Digital I/O 6	PL e, two channel with 2 pulses
6	X22	1	IO 07	Digital I/O 7	PL e, two channel with 2 pulses
		2	IO 08	Digital I/O 8	PL e, two channel with 2 pulses
		3	IO 09	Digital I/O 9	PL e, two channel with 2 pulses
		4	IO 10	Digital I/O 10	PL e, two channel with 2 pulses
7	X23	1	DI 05	Digital IN 05	PL d, single channel
		2	DI 06	Digital IN 06	PL d, single channel
		3	DI 07	Digital IN 07	PL d, single channel
		4	DI 08	Digital IN 08	PL d, single channel
8	X24	1	DI 09	Digital IN 09 OSSD-compatible	PL e
		2	DI 10	Digital IN 10 OSSD-compatible	PL e
		3	DI 11	Digital IN 11 OSSD-compatible	PL e
		4	DI 12	Digital IN 12 OSSD-compatible	PL e

Safety systems CMGA, extension module

Technical data

FESTO

Dimensions

Download CAD data → www.festo.com

CMGA-E1

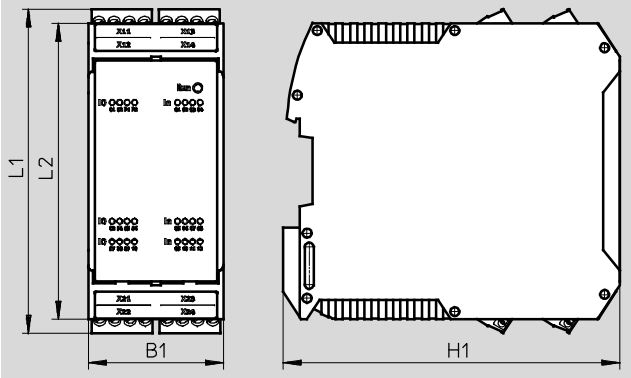

CMGA-E1-CO

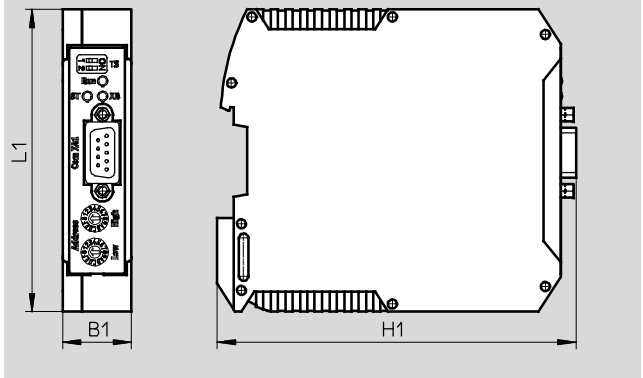

CMGA-E1-DN

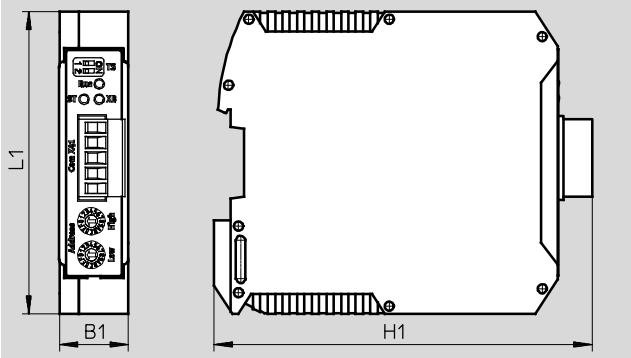

CMGA-E1-PB

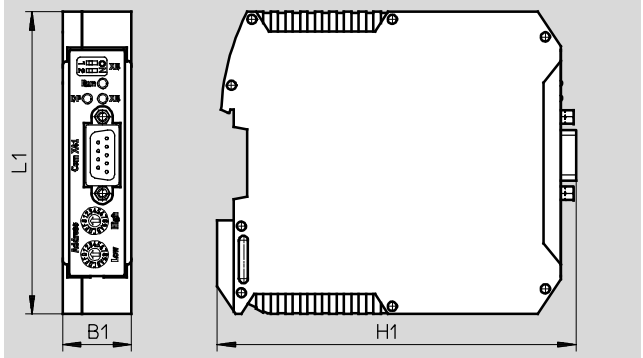

Type	B1	H1	L1	L2
CMGA-E1	45	113	108	99
CMGA-E1-CO	23	118	99	-
CMGA-E1-DN	23	124	99	-
CMGA-E1-PB	23	118	99	-

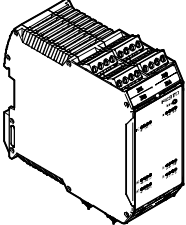

Ordering data

Type	Description	Part No.	Type
	Extension module I/O	1680826	CMGA-E1
	CANopen extension module	1680828	CMGA-E1-CO
	DeviceNet extension module	1680829	CMGA-E1-DN
	Profibus DP extension module	1680827	CMGA-E1-PB

Safety systems CMGA

Accessories

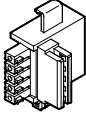
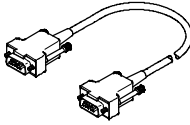
FESTO

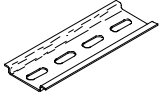
Ordering data				
Type	Brief description	Cable length [m]	Part No.	Type
	Plug connector for connecting the modules to one another via a rear wall bus	–	1680832	NEKM-C-13
	Encoder cable for connection between safety system CMGA and motor controller CMM...	0.5	1680830	NEBC-S1G9-K-0.5-N-S-S1G9
		2	1680831	NEBC-S1G9-K-2-N-S-S1G9
	Programming cable, converts the USB interface on the PC for CMGA modules	–	1680835	NEBC-U1G4-K-2-N-R5G4
	Scope of delivery: <ul style="list-style-type: none"> • USB cable • Programming cable • Programming adapter 			
	Mounting rail for attaching the safety systems	–	35430	NRH-35-2000

Ordering data				
Type	Brief description	Part No.	Type	
	Programming software for creating custom application programs	1680833	GSPF-CMGA-BS-1	
	Configuration software for programming previously created application programs → Support Portal	1680834	GSPF-CMGA-BS-2	