

Pressure regulator VRPA

FESTO

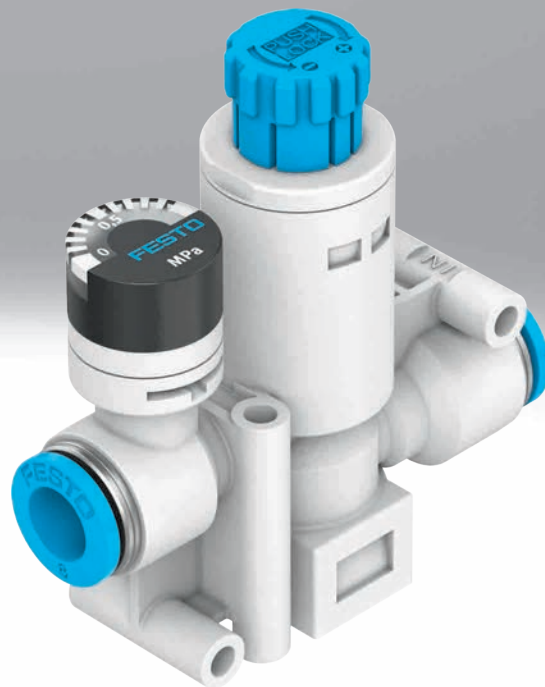

Product range overview and type codes

Product range overview

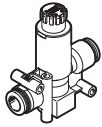
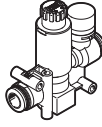
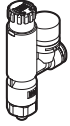
Design	Version	Type	Pneumatic connection		Standard nominal flow rate [l/min]
			1	2	
Inline	Without pressure gauge				
		VRPA-C	QS-4	QS-4	80
			QS-6	QS-6	90
			QS-8	QS-8	130
	With pressure gauge, pressure gauge scale in MPa				
		VRPA-CM	QS-4	QS-4	80
QS-6			QS-6	90	
QS-8			QS-8	125	
L-shape	With pressure gauge, pressure gauge scale in MPa				
		VRPA-LM	M5	QS-4	80
				QS-6	90
			R1/8	QS-4	90
				QS-6	100
				QS-8	110
			R1/4	QS-6	115
				QS-8	130

Type codes

001	Series
VRPA	Pressure regulator

002	Design
C	Inline
L	L-shape

003	Pressure indication
	Without pressure gauge
M	With pressure gauge

004	Pneumatic connection 1
Q4	Push-in connector 4 mm
Q6	Push-in connector 6 mm
Q8	Push-in connector 8 mm
M5	M5
R18	R1/8
R14	R1/4

005	Pneumatic connection 2
Q4	Push-in connector 4 mm
Q6	Push-in connector 6 mm
Q8	Push-in connector 8 mm
E	Same size as connection 1

Data sheet

Inline, with/without pressure gauge

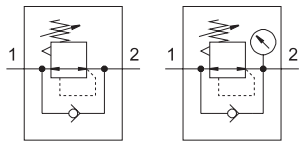

-  - Standard nominal flow rate
80 ... 130 l/min



L-shape, with pressure gauge

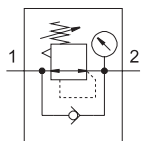

-  - Standard nominal flow rate
80 ... 130 l/min



General technical data

Pneumatic connection 1	QS-4	QS-6	QS-8	M5	R1/8	R1/4
Pneumatic connection 2	QS-4	QS-6	QS-8	QS-4, QS-6	QS-4, QS-6, QS-8	QS-6, QS-8
Controller function	Outlet pressure constant, with secondary venting, with return flow action					
Pressure regulation range [MPa]	0.1 ... 0.8					
Actuation type	Manual					
Mounting position	Any					
Adjusting element	Rotary knob with detent					
Pressure indicator	With/without pressure gauge			With pressure gauge		
Type of mounting	With through-hole			Screw-in		
Type of seal on screwed trunnion	-		Sealing ring		Coating	
Rotatability	-			360°/continuous rotation not permitted		
Nominal tightening torque [Nm]	-		0.8 ±20%		-	

Operating and environmental conditions

Operating pressure	See graph → page 5					
Operating medium	Compressed air to ISO 8573-1:2010 [7:4:4]					
Note on the operating/pilot medium	Lubricated operation possible (in which case lubricated operation will always be required)					
Ambient temperature [°C]	0 ... +60					

Materials

Pneumatic connection 1	QS-4	QS-6	QS-8	M5	R1/8	R1/4
Housing	PBT			PBT		
Screwed trunnion	-			Nickel-plated brass		
Threaded seal	-		-		PTFE	
Static seals	NBR			NBR		
Note on materials	RoHS-compliant			RoHS-compliant		

Data sheet

Operating pressure p as a function of temperature t

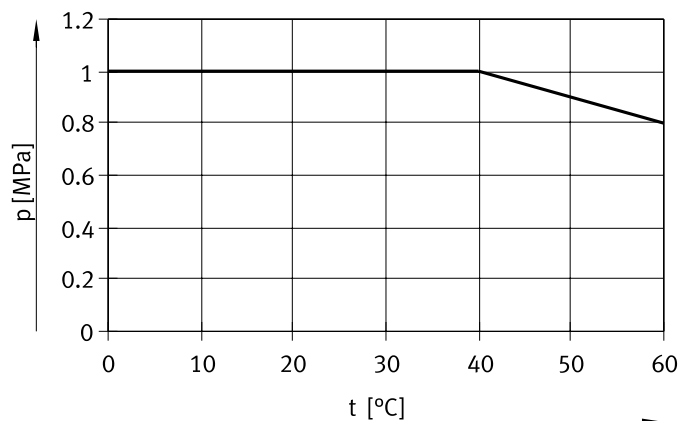

Dimensions – Inline

Download CAD data → www.festo.com

VRPA-C, without pressure gauge

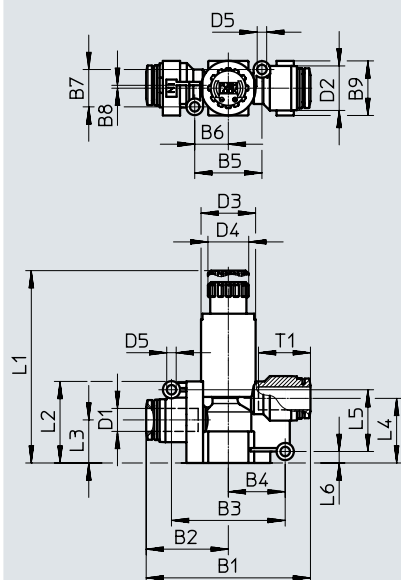

VRPA-CM, with pressure gauge

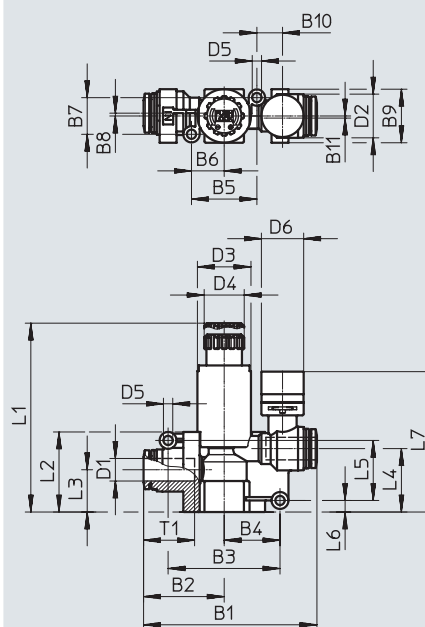

Type	B1	B2	B3	B4	B5	B6	B7	B8	B9	B10	B11	D1 ∅	D2 ∅
VRPA-C-Q4-E	44.4	22.2	30	15	20.6	10.3	9	1	15	-	-	4	11.5
VRPA-C-Q6-E	44.6	22.3	30	15	20.6	10.3	9	1	15	-	-	6	11.5
VRPA-C-Q8-E	57.2	28.6	39.6	19.8	23.4	11.7	13	1	19	-	-	8	15.5
VRPA-CM-Q4-E	53.4	22.2	30	15	20.2	10.1	9	1	15	10.2	1	4	11.5
VRPA-CM-Q6-E	53.6	22.3	30	15	20.2	10.1	9	1	15	10.2	1	6	11.5
VRPA-CM-Q8-E	61.5	28.6	39.7	19.9	23.2	11.6	13	1	19	9.1	0	8	15.5

Type	D3 ∅	D4 ∅	D5 ∅	D6 ∅	L1		L2	L3	L4	L5	L6	L7	T1
					Unlocked	Locked							
VRPA-C-Q4-E	15	14.2	3.3	-	61.6	58.9	24.5	13	18.8	17	4.2	-	11.6
VRPA-C-Q6-E	15	14.2	3.3	-	61.6	58.9	24.5	13	18.8	17	4.2	-	11.9
VRPA-C-Q8-E	19	14.2	3.3	-	65.7	63	28.4	15	22.5	21.5	4	-	18.1
VRPA-CM-Q4-E	15	14.2	3.3	15	61.6	58.9	24.5	13	18.8	17	4.2	43.3	11.6
VRPA-CM-Q6-E	15	14.2	3.3	15	61.6	58.9	24.5	13	18.8	17	4.2	43.3	11.9
VRPA-CM-Q8-E	19	14.2	3.3	15	65.7	63	28.4	15	22.5	21.3	4.1	49.8	18.1

Data sheet

Dimensions – L-shape

Download CAD data → www.festo.com

VRPA-LM, with pressure gauge

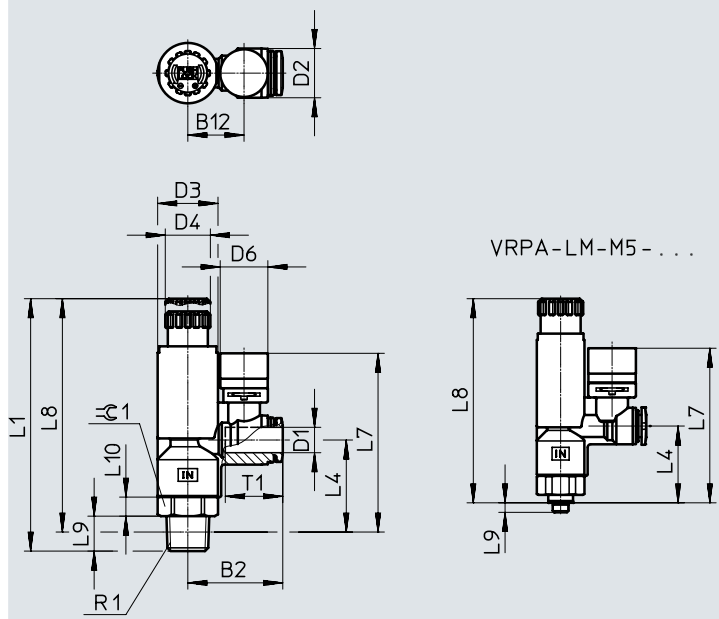

Type	B2	B12	D1 ∅	D2 ∅	D3 ∅	D4 ∅	D6 ∅
VRPA-LM-M5-Q4	26.9	16.2	4	11.5	15	14.2	15
VRPA-LM-M5-Q6	27	16.2	6	11.5	15	14.2	15
VRPA-LM-R18-Q4	26.9	16.2	4	11.5	15	14.2	15
VRPA-LM-R18-Q6	27	16.2	6	11.5	15	14.2	15
VRPA-LM-R18-Q8	28.4	16.2	8	15.5	15	14.2	15
VRPA-LM-R14-Q6	30	17.7	6	15.5	19	14.2	15
VRPA-LM-R14-Q8	29.9	17.7	8	15.5	19	14.2	15

Type	L1		L4	L7	L8		L9	L10	R1	T1	≈ 1
	Unlocked	Locked			Unlocked	Locked					
VRPA-LM-M5-Q4	70	67.3	24.2	48.7	66.8	64.3	3	6	M5x0.8	11.6	14
VRPA-LM-M5-Q6	70	67.3	24.2	48.7	66.8	64.3	3	6	M5x0.8	11.9	14
VRPA-LM-R18-Q4	71.5	68.8	24.7	49.2	67.3	64.8	8	5	R1/8	11.6	14
VRPA-LM-R18-Q6	71.5	68.8	24.7	49.2	67.3	64.8	8	5	R1/8	11.9	14
VRPA-LM-R18-Q8	71.5	68.8	24.7	52	67.3	64.8	8	5	R1/8	18.1	14
VRPA-LM-R14-Q6	78.2	75.5	29	56.3	72	69.5	11	6	R1/4	17	17
VRPA-LM-R14-Q8	78.2	75.5	29	56.3	72	69.5	11	6	R1/4	18.1	17

Data sheet

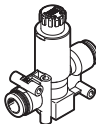
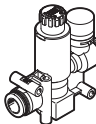
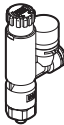
Ordering data		Pneumatic connection		Standard nominal flow rate [l/min]	Weight [g]	Part no.	Type
		1	2				
Inline, without pressure gauge							
	QS-4	QS-4	80	19	8086000	VRPA-C-Q4-E	
	QS-6	QS-6	90	20	8086001	VRPA-C-Q6-E	
	QS-8	QS-8	130	33	8086002	VRPA-C-Q8-E	
Inline, with pressure gauge, pressure gauge scale in MPa							
	QS-4	QS-4	80	23	8086003	VRPA-CM-Q4-E	
	QS-6	QS-6	90	23	8086004	VRPA-CM-Q6-E	
	QS-8	QS-8	125	36	8086005	VRPA-CM-Q8-E	
L-shape, with pressure gauge, pressure gauge scale in MPa							
	M5	QS-4	80	29	8086007	VRPA-LM-M5-Q4	
		QS-6	90	29	8086008	VRPA-LM-M5-Q6	
	R1/8	QS-4	90	29	8086009	VRPA-LM-R18-Q4	
		QS-6	100	29	8086010	VRPA-LM-R18-Q6	
		QS-8	110	31	8086011	VRPA-LM-R18-Q8	
	R1/4	QS-6	115	49	8086012	VRPA-LM-R14-Q6	
QS-8		130	49	8086013	VRPA-LM-R14-Q8		

Festo - Your Partner in Automation



1 Festo Inc.
5300 Explorer Drive
Mississauga, ON L4W 5G4
Canada

Festo Customer Interaction Center
Tel: 1 877 463 3786
Fax: 1 877 393 3786
Email: customer.service.ca@festo.com



2 Festo Pneumatic
Av. Ceylán 3,
Col. Tequesquináhuac
54020 Tlalnepantla,
Estado de México

Multinational Contact Center
01 800 337 8669
ventas.mexico@festo.com



3 Festo Corporation
1377 Motor Parkway
Suite 310
Islandia, NY 11749

Festo Customer Interaction Center
1 800 993 3786
1 800 963 3786
customer.service.us@festo.com



4 Regional Service Center
7777 Columbia Road
Mason, OH 45040

Connect with us



www.festo.com/socialmedia



www.festo.com

Subject to change