

## Sub-bases VABP

**FESTO**



## Key features

### At a glance

The sub-base VABP can be used to help implement specific switch-off behaviour when switching off the valve load voltage. It is a single-channel solution for uncoupling the drive from the power valve.

4 switch-off functions are possible.

The sub-base is not a safety device, nor is it a complete safety solution. However, it can form part of a safety solution.

Key features:

- Compact design
- Simple installation
- Suitable for servo-pneumatic drives
- Can be attached directly to the proportional directional control valve VPWP
- Connecting cable for direct connection to the proportional directional control valve VPWP
- Suitable for cylinders that are controlled by 5/2- or 5/3-way valves
- For ISO valves with spring return and external auxiliary pilot air
- Extended range of accessories:
- ISO solenoid valves with switching position sensing for producing a diagnostic rate > 60%

### The technology in detail

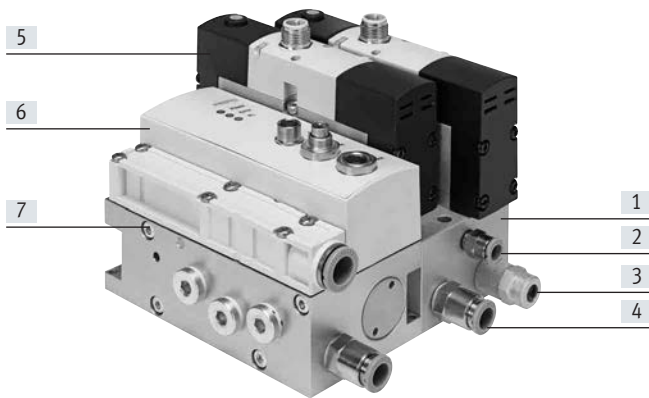

- [1] Sub-base VABP  
(example with valves mounted)
- [2] Pilot port
- [3] Function port B
- [4] Function port A
- [5] Solenoid valve VSVA, MN1H
- [6] Proportional directional control valve VPWP
- [7] Retaining screws

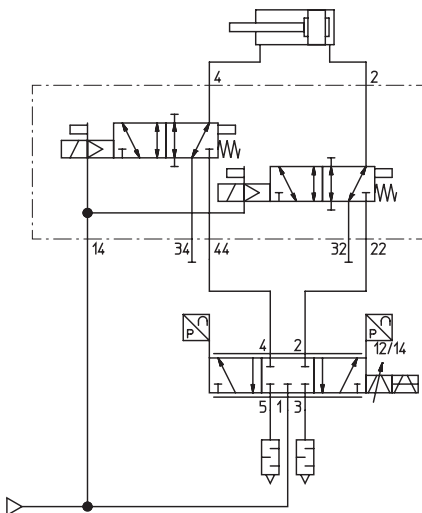

The 4 different single-channel switch-off functions can be configured using function ports 32 (A) and 34 (B):

- Stopping a movement: blocking
- De-energising: exhausting
- Reversing with reduced speed
- Switching off power: short-circuit

### Note

An application document "Demonstrating VABP protective measures" is available from the Support Portal.

## Type codes

<b>001</b>	<b>Series</b>	
<b>VABP</b>	Sub-base	
<b>002</b>	<b>Allocation</b>	
<b>S1</b>	Version S1	
<b>S3</b>	Version S3	
<b>003</b>	<b>Size</b>	
<b>26</b>	Size 26	
<b>1</b>	Size 1	
<b>2</b>	Size 2	
<b>004</b>	<b>Version</b>	
<b>V1</b>	Switching variant, emergency stop functions	
<b>005</b>	<b>Connection type</b>	
<b>G</b>	Supply air/exhaust air/pilot supply air/pilot exhaust air	

<b>006</b>	<b>Pneumatic connection</b>	
<b>G18</b>	G1/8	
<b>G14</b>	G1/4	
<b>G38</b>	G3/8	
<b>007</b>	<b>Valve positions</b>	
<b>2</b>	2 valve positions	
<b>008</b>	<b>Equipment</b>	
	Without valves	
<b>M</b>	With valves	
<b>009</b>	<b>Electrical connection</b>	
	None	
<b>A1</b>	Plug pattern type A, to EN 175301-803	
<b>R3</b>	M12 individual plug (5-pin)	

## Peripherals overview

### VABP-S3-26V1G / VABP-S1-1V1G

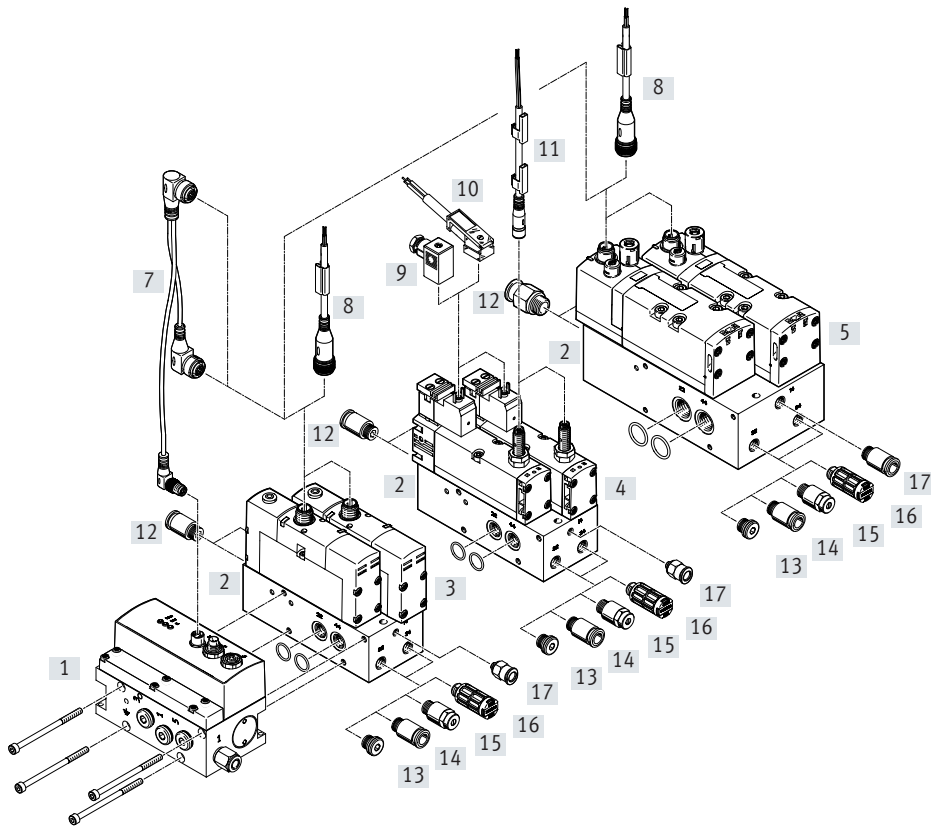

### VABP-S1-2V1G

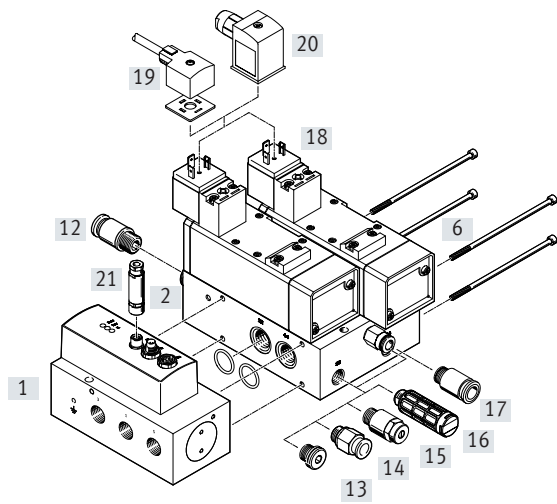

## Peripherals overview

Accessories	See allocation table below				Description	→ Page/ Internet
	[3]	[4]	[5]	[6]		
[1] Proportional directional control valve VPWP	■	■	■	■	5/3-way proportional directional control valve for applications with Soft Stop and for pneumatic positioning	vpwp
[2] Sub-base VABP	■	■	■	■	For realising specific switch-off functions	6
[7] Connecting cable NEDV	■	-	■	-	Connecting solenoid valve to proportional directional control valve VPWP	15
[8] Connecting cable NEBU-M12	■	-	■	-	<ul style="list-style-type: none"> <li>Connecting solenoid valve to controller.</li> <li>Alternative to [7]</li> </ul>	15
[9] Plug socket MSSD-EB	-	■	-	-	<ul style="list-style-type: none"> <li>Connecting solenoid valve to controller.</li> <li>Alternative to [10]</li> </ul>	15
[10] Plug socket with cable KMEB	-	■	-	-	Connecting solenoid valve to controller.	15
[11] Connecting cable NEBU-M8	-	■	-	-	Connecting switching position sensing system to controller	15
[12] Push-in fitting QS	■	■	■	■	For working ports 2 and 4	15
[13] Blanking plug B	■	■	■	■	<ul style="list-style-type: none"> <li>For function ports 32 and 34</li> <li>For implementing a switch-off function</li> </ul>	14
[14] Push-in fitting QS	■	■	■	■	<ul style="list-style-type: none"> <li>For function ports 32 and 34</li> <li>For implementing a switch-off function</li> </ul>	15
[15] Exhaust air flow control valve GRE	■	■	■	■	<ul style="list-style-type: none"> <li>For function ports 32 and 34</li> <li>For implementing a switch-off function</li> </ul>	14
[16] Silencer UC	■	■	■	■	<ul style="list-style-type: none"> <li>For function ports 32 and 34</li> <li>For implementing a switch-off function</li> </ul>	14
[17] Push-in fitting QS	■	■	■	■	For pilot air port 14	15
[18] Solenoid coil MSN1G	-	-	-	■	For actuating the solenoid valve	14
[19] Connecting cable KMC	-	-	-	■	Connecting solenoid valve to controller	15
[20] Plug socket MSSD-C	-	-	-	■	<ul style="list-style-type: none"> <li>Connecting solenoid valve to controller.</li> <li>Alternative to [19]</li> </ul>	15
[21] Plug NECU	-	-	-	■	For connecting the solenoid valves to the proportional directional control valve VPWP	15

Allocation table		
Sub-base	Solenoid valve (→ page 14)	Proportional directional control valve
[3] VABP-S3-26V1G	VSVA-B-M52-MZH-A1-1R5L	VPWP-4/-6
[4] VABP-S3-26V1G	VSVA-B-M52-MZ-A1-1C1-APP <sup>1)</sup>	VPWP-4/-6
[5] VABP-S1-1V1G	VSVA-B-M52-MZD-D1-1R5L	VPWP-8
[6] VABP-S1-1V1G	MN1H-5/2-D-2-FR-S-C	VPWP-10

1) Solenoid valve with switching position sensing

## Datasheet

-  - Flow rate  
800 ... 2000 l/min

-  - Pressure  
0 ... 16 bar

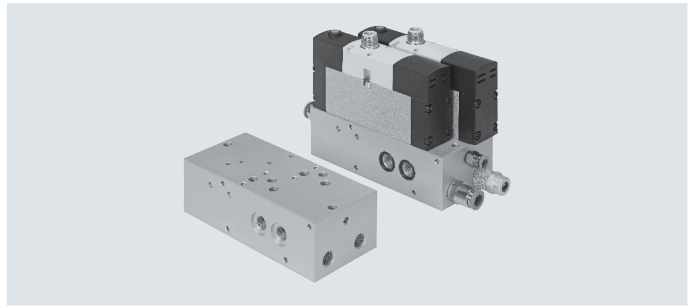

### General technical data

Type	VABP-S3-26V1G	VABP-S1-1V1G	VABP-S1-2V1G
For proportional directional control valve	VPWP-4/-6	VPWP-8	VPWP-10
Width [mm]	26	42	54
Pneumatic connection			
Working ports: 2, 4, 22, 44	G1/8	G1/4	G3/8
Pilot air supply: 14	M5	G1/8	G1/8
Function ports: 32, 34	G1/8	G1/8	G1/4
Standard nominal flow rate [l/min]	800	1400	2000
Mounting position			
Product weight			
Without valves [g]	668	1623	1950
With valves [g]	1200	2480	3400
With solenoid valve	[1]	[2]	[3]
Valve function	5/2		[4]
Reset method	Mechanical spring		
Type of control	Piloted		
Pilot air supply	External		
Flow direction	Reversible		
Switching position sensing	-	Yes	-
Switching element function	-	N/C	-
Switching output	-	PNP	-
Nominal width	9	11	11
Actuation type	Electrical		
Manual override	Without or covered		
Nominal operating voltage [V]	24		
Permissible voltage fluctuation [%]	±10	±10	-15/±10

## Datasheet

Operating and environmental conditions				
Type		VABP-S3-26V1G	VABP-S1-1V1G	VABP-S1-2V1G
Operating medium <sup>1)</sup>		Compressed air to ISO 8573-1:2010 [6:4:4]		
Operating pressure <sup>1)</sup>	[bar]	0 ... 16		
Pilot pressure with valves	[bar]	3 ... 8		
Ambient temperature	[°C]	0 ... 50		
Temperature of medium	[°C]	0 ... 50		

1) Note operating range of connected components.

Materials				
Type		VABP-S3-26V1G	VABP-S1-1V1G	VABP-S1-2V1G
Manifold rail		Wrought aluminium alloy		
O-ring		NBR		
Screws		Steel		
Note on materials		RoHS-compliant		

### Configuring the switch-off functions

The sub-base is not a safety device, nor is it a complete safety solution. However, it can form part of a safety solution.

Suitable accessories must be mounted at the function ports [32] and [34] in order to configure the different switch-off functions.

Sub-base	Silencer	Blanking plug	Exhaust air flow control valve	Push-in fitting
VABP-S3-26V1G	U-1/8	B-1/8	GRE-1/8	QS-G1/8-4, 6 or 8
VABP-S1-1V1G	U-1/8	B-1/8	GRE-1/8	QS-G1/8-4, 6 or 8
VABP-S1-2V1G	U-1/4	B-1/4	GRE-1/4	QS-G1/8-6, 8 or 10

### Switch-off variants

#### Circuit 1: Stopping a movement - blocking

When the valves are switched off, the movement of the drive will be stopped.

Note:

- Following actuation of the switch-off function, the drive will be under pressure
- In the case of a vertical mounting position, it is possible that the payload will slowly drop

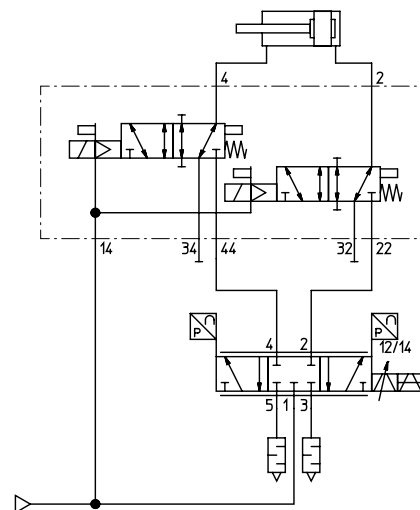
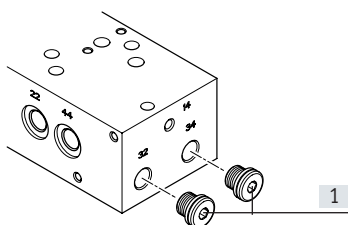

[1] Blanking plug

## Datasheet

### Switch-off variants

#### Circuit 2: De-energising - exhausting

When the valves are switched off, the drive will be exhausted.

Note:

- Not suitable for a vertical mounting position without additional safety functions
- If the exhaust air flow control valves are closed, the drive will not be exhausted
- Exhausting is also possible via the silencer

[1] Exhaust air flow control valve or silencer

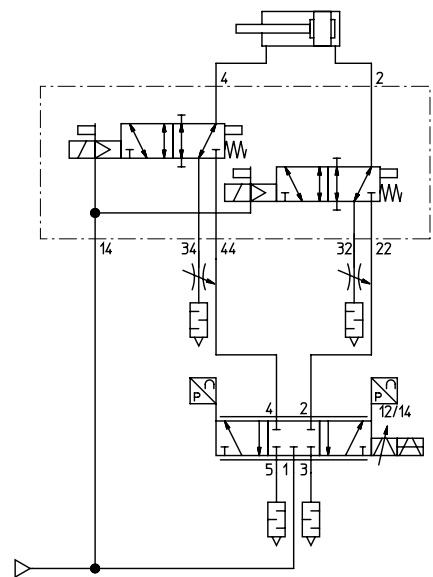
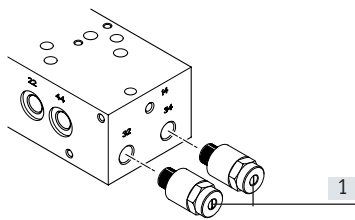

#### Circuit 3: Reversing (advancing) and reducing speed

When the solenoid valves are switched off, the movement of a retracting drive is reversed with simultaneous reduction of speed. The drive travels into the end position.

Note:

- The holding function is time-limited
- To generate the reversing movement even in the event of compressed air failure, an air reservoir with non-return function can be inserted at port [32] for compressed air supply.

[1] Exhaust air flow control valve

[2] Push-in fitting

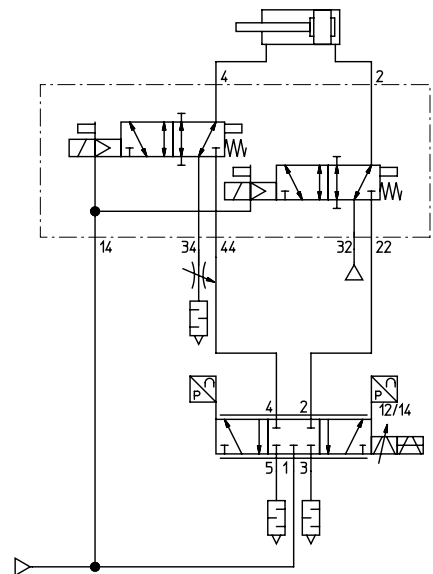
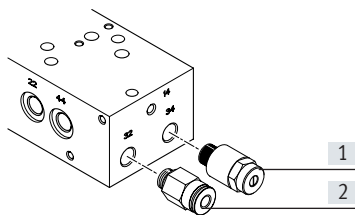



## Datasheet

### Switch-off variants

#### Circuit 4: Reversing (retracting) and reducing speed

When the solenoid valves are switched off, the movement of an extending drive is reversed with simultaneous reduction of speed. The drive travels into the end position.

Note:

- The holding function is time-limited
- To generate the reversing movement even in the event of compressed air failure, an air reservoir with non-return function can be inserted at port [34] for compressed air supply.

- [1] Push-in fitting  
[2] Exhaust air flow control valve

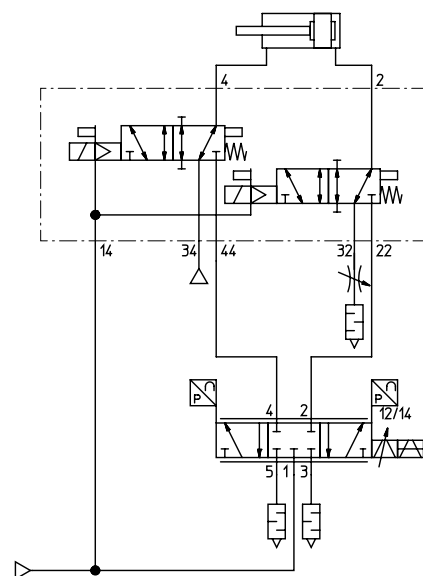
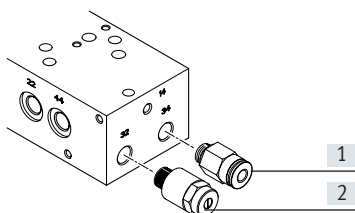

#### Circuit 5: Switching off power – short-circuit

When the valves are switched off, the two chambers are interconnected. The drive comes to a stop.

Note:

- Following actuation of the switch-off function, the drive will be under pressure
- Not suitable for a vertical mounting position without additional safety functions
- To restrict the run-out movement, it is recommended that a thin tube (4 or 6 mm) is used for connecting the ports [32] and [34] or a throttle valve (e.g. GRO...) is used.

- [1] Push-in fitting  
[2] Tubing  
[3] Throttle valve

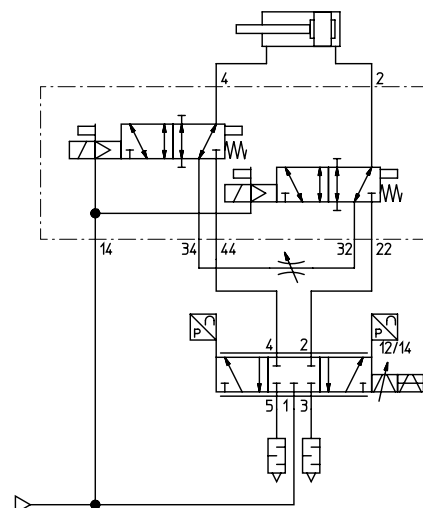
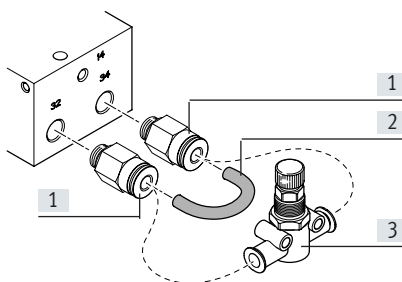

Datasheet

Dimensions

Download CAD data → [www.festo.com](http://www.festo.com)

VABP-S3-26V1G

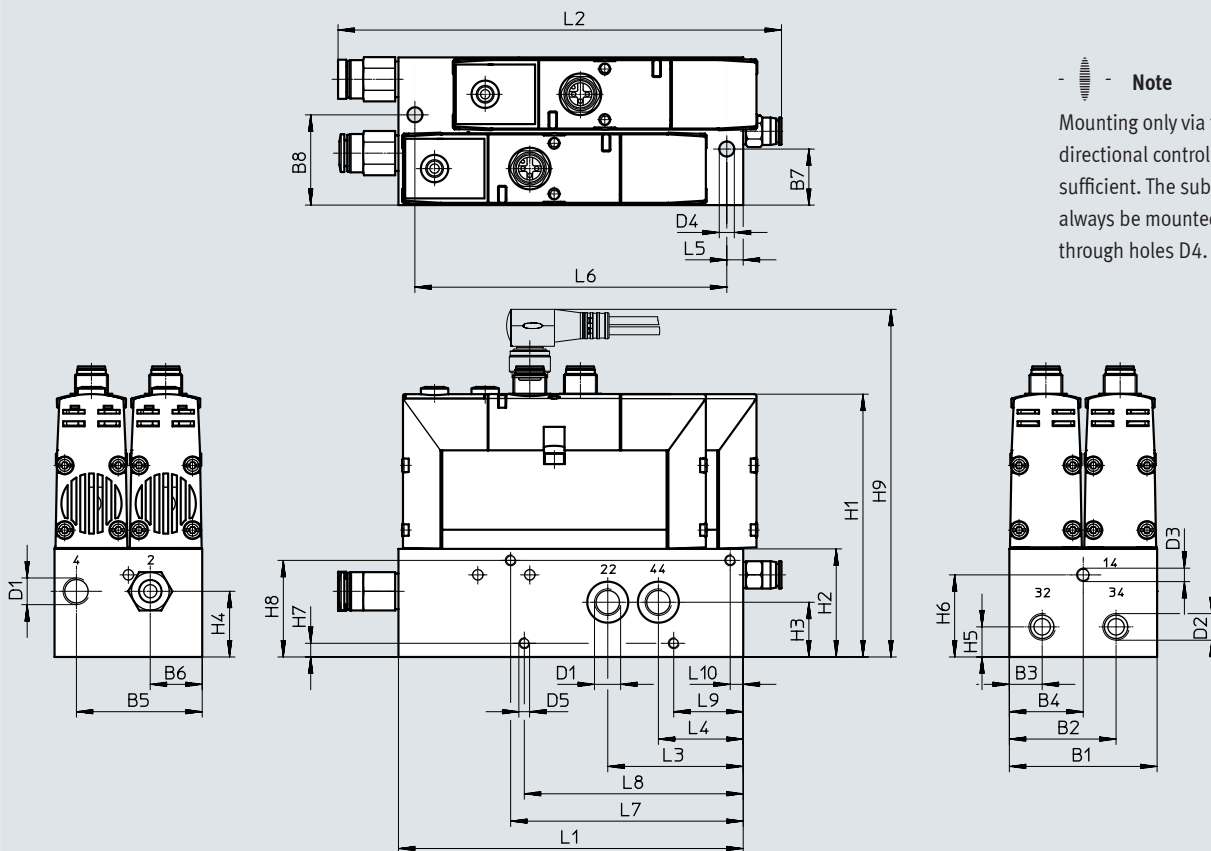

**Note**  
 Mounting only via the proportional directional control valve VPWP is not sufficient. The sub-base must also always be mounted directly using the through holes D4.

	B1	B2	B3	B4	B5	B6	B7	B8
Without valves	54	39	12	27	46	19	20.5	33
With valves								
	D1	D2	D3	D4	D5	H1	H2	H3
Without valves	G1/8	G1/8	M5	5.5	M4	-	39.5	20
With valves						96		
	H4	H5	H6	H7	H8	H9	L1	L2
Without valves	24	11	30	±0.1	±0.1	-	126	-
With valves						124.5		162
	L3	L4	L5	L6	L7	L8	L9	L10
Without valves	49.5	31	6	120	±0.1	±0.1	±0.1	±0.1
With valves								

Datasheet

Dimensions

Download CAD data → [www.festo.com](http://www.festo.com)

VABP-S1-1V1G

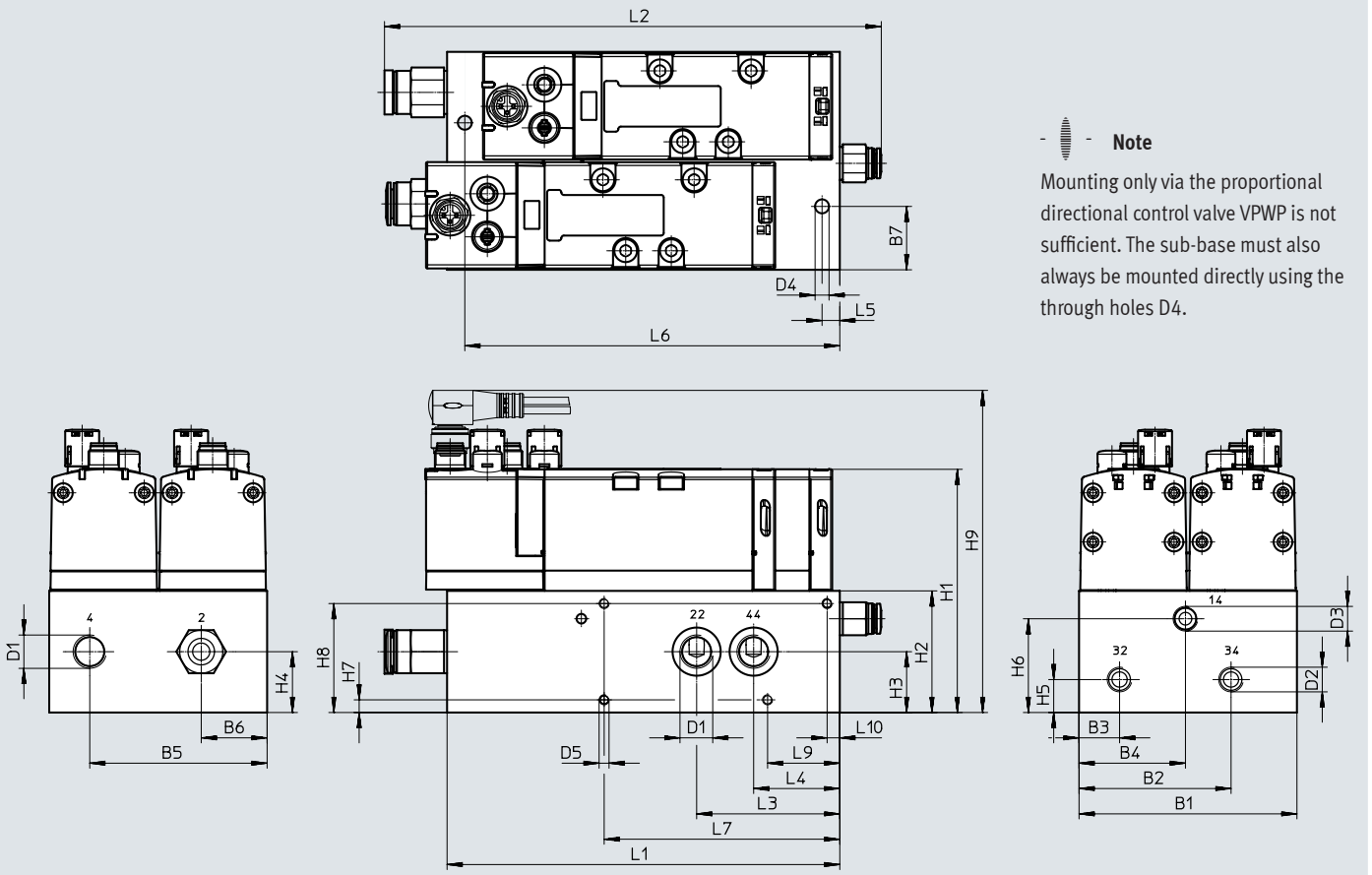

	B1	B2	B3	B4	B5	B6	B7	B8
Without valves	86	60	16	42	70	26	25	58
With valves								
	D1	D2	D3	D4	D5	H1	H2	H3
Without valves	G1/4	G1/8	G1/8	5.5	M4	-	48	24
With valves						96		
	H4	H5	H6	H7	H8	H9	L1	L2
Without valves	24	13	37	±0.1	±0.1	-	155	-
With valves						132		196
	L3	L4	L5	L6	L7	L9	L10	
Without valves	56.5	34	7	148	±0.1	±0.1	±0.1	
With valves								

# Datasheet

## Dimensions

Download CAD data → [www.festo.com](http://www.festo.com)

VABP-S3-26V1G

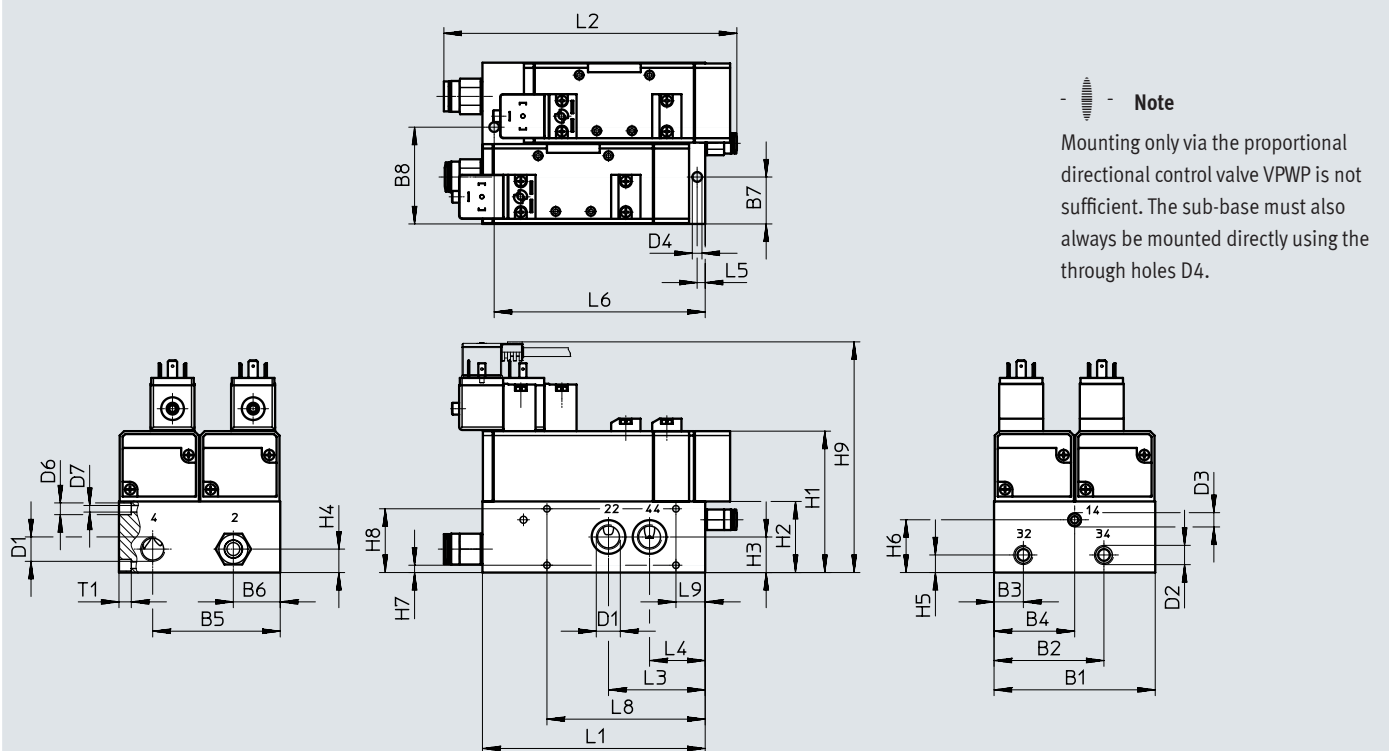

	B1	B2	B3	B4	B5	B6	B7	B8
Without valves	110	75	20	55	87	32	32	66
With valves								
	D1	D2	D3	D4 ∅	D6 ∅ H13	D7 ∅ H13	H1	H2
Without valves	G3/8	G1/4	G1/8	6.6	4.5	8	–	48.5
With valves							96.5	
	H3	H4	H5	H6	H7 ±0.1	H8 ±0.1	H9	L1
Without valves	24.3	16	12	36	5	43.5	–	152
With valves							157	
	L2	L3	L4	L5	L6	L8 ±0.1	L9 ±0.1	T1
Without valves	–	66	38	5.5	144	108	20	8.4
With valves	200							



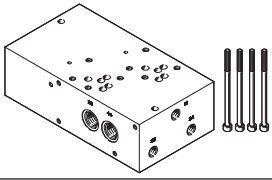
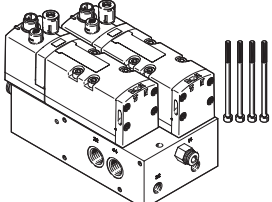

## Datasheet

Ordering data		Standard nominal flow rate	Part no.	Type
<b>Without valves</b>				
	800	2605074	VABP-S3-26V1G-G18-2	
	1400	2614860	VABP-S1-1V1G-G14-2	
	2000	2738671	VABP-S1-2V1G-G38-2	
<b>With valves</b>				
	800	2605075	VABP-S3-26V1G-G18-2M-R3	
	1400	2614863	VABP-S1-1V1G-G14-2M-R3	
	2000	2738672	VABP-S1-2V1G-G38-2M-A1	

**Note**

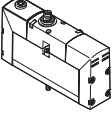
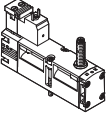
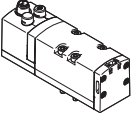
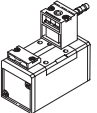
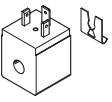

The solenoid valve VSVA with switching position sensing must be ordered separately  
 → page 14

Accessories

Ordering data	Description	Part no.	Type	PU <sup>1)</sup>
<b>Solenoid valve</b>				
	For sub-base: • VABP-S3-26V1G-G18-2	534546	VSVA-B-M52-MZH-A1-1R5L	1
	For sub-base: • VABP-S3-26V1G-G18-2 • With switching position sensing via inductive proximity switch	560726	VSVA-B-M52-MZ-A1-1C1-APP	1
	For sub-base: • VABP-S1-1V1G-G14-2	561373	VSVA-B-M52-MZD-D1-1R5L	1
	For sub-base: • VABP-S1-2V1G-G38-2	159718	MN1H-5/2-D-2-FR-S-C	1
<b>Solenoid coil</b>				
	For solenoid valve: • MN1H-5/2-D-2-FR-S-C	123060	MSN1G-24DC-OD	1
<b>Blanking plug</b>				
	For implementing a switch-off function	3568	B-1/8	10
		3569	B-1/4	
<b>Silencer</b>				
	For implementing a switch-off function	161419	UC-1/8	1
		165004	UC-1/4	
<b>Exhaust air flow control valve</b>				
	For implementing a switch-off function	10351	GRE-1/8	1
		10352	GRE-1/4	
<b>Throttle valve</b>				
	For implementing a switch-off function	193973	GRO-QS-6	1

1) Packaging unit

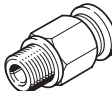
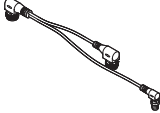
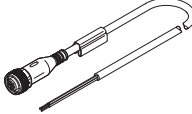
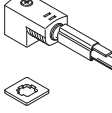
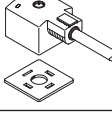
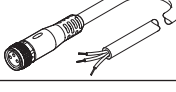
## Accessories

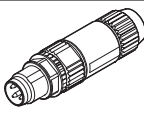
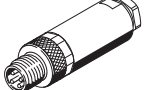
Ordering data	Description	Part no.	Type	PU <sup>1)</sup>
<b>Push-in fitting (use push-in fitting with sealing ring only)</b>				
	For pilot air port 14			
	VABP-S3-26V1G	130896	QSM-B-M5-6-20	20
	VABP-S1-1V1G	186096	QS-G1/8-6	10
	VABP-S1-2V1G	186098	QS-G1/8-8	
	For function ports 32, 34			
	VABP-S3-26V1G	186096	QS-G1/8-6	10
	VABP-S1-1V1G	186098	QS-G1/8-8	
	VABP-S1-2V1G	186099	QS-G1/4-8	
	For working ports 2, 4, 22, 44			
	VABP-S3-26V1G	186098	QS-G1/8-8	10
VABP-S1-1V1G	186101	QS-G1/4-10		
VABP-S1-2V1G	186103	QS-G3/8-12		
<b>Connecting cable and plug socket with cable</b>				
	Connecting solenoid valve to proportional directional control valve VPWP. For the solenoid valves: • VSVA-B-M52-MZH-A1-1R5L • VSVA-B-M52-MZD-D1-1R5L	2384165	NEDV-L2R1-V7-M12W3-K-0.1L1-N-M8W4-0.2R1	1
	Connecting solenoid valve to controller. For the solenoid valves: • VSVA-B-M52-MZH-A1-1R5L • VSVA-B-M52-MZD-D1-1R5L	541363	NEBU-M12G5-K-2.5-LE3	1
		541364	NEBU-M12G5-K-5-LE3	
	Connecting solenoid valve to controller. For solenoid valve with switching position sensing: • VSVA-B-M52-MZ-A1-1C1-APP	151688	KMEB-1-24-2.5-LED	1
		151689	KMEB-1-24-5-LED	
	Connecting solenoid valve to controller. For solenoid valve: • MN1H-5/2-D-2-FR-S-C	30931	KMC-1-24DC-2.5-LED	1
		30933	KMC-1-24DC-5-LED	
	Connecting switching position sensing system to controller	541334	NEBU-M8G3-K-5-LE3	1
<b>Plug and plug socket</b>				
	Alternative plug socket for solenoid valve. For solenoid valve with switching position sensing: • VSVA-B-M52-MZ-A1-1C1-APP	151687	MSSD-EB	1
	Alternative plug socket for solenoid valve. For solenoid valve: • MN1H-5/2-D-2-FR-S-C	34583	MSSD-C	1
	• Insulation displacement connector • Connecting the cable KMC to the proportional directional control valve VPWP	562025	NECU-S-M8G4-HX	1
	• Insulation displacement connector • Connecting the cable KMC to the proportional directional control valve VPWP	1068198	NECU-S-M8G4-C2	1

1) Packaging unit

# Festo - Your Partner in Automation



**1 Festo Inc.**  
5300 Explorer Drive  
Mississauga, ON L4W 5G4  
Canada

**Festo Customer Interaction Center**  
Tel: 1 877 463 3786  
Fax: 1 877 393 3786  
Email: [customer.service.ca@festo.com](mailto:customer.service.ca@festo.com)

**2 Festo Pneumatic**  
Av. Ceylán 3,  
Col. Tequesquináhuac  
54020 Tlalnepantla,  
Estado de México

**Multinational Contact Center**  
01 800 337 8669  
[ventas.mexico@festo.com](mailto:ventas.mexico@festo.com)

**3 Festo Corporation**  
1377 Motor Parkway  
Suite 310  
Islandia, NY 11749

**Festo Customer Interaction Center**  
1 800 993 3786  
1 800 963 3786  
[customer.service.us@festo.com](mailto:customer.service.us@festo.com)

**4 Regional Service Center**  
7777 Columbia Road  
Mason, OH 45040

Connect with us



[www.festo.com/socialmedia](http://www.festo.com/socialmedia)



[www.festo.com](http://www.festo.com)

Subject to change