

Proximity switch for T-slot

FESTO

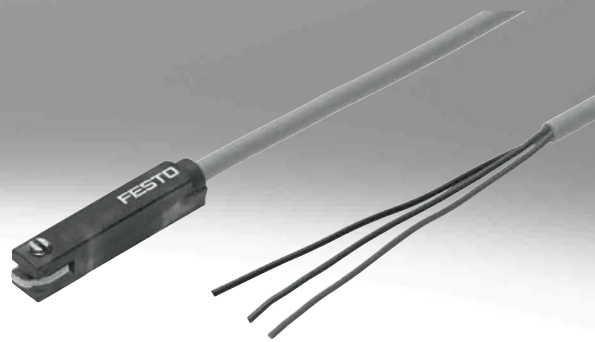

Festo Core Range
Solves the majority of your automation tasks

With the Festo Core Range, we have selected the most important products and functions from our broad product catalogue, and added the quickest delivery.

Worldwide: Quickest delivery – wherever, whenever
Simply good: Expected high Festo quality
Fast: Easy and fast to select

The Core Range offers you the best value for your automation tasks.

Just look
for the
star!

Product range overview

Design	Type of mounting	Measuring principle	Type	Operating voltage range	Switching output	Switching element function	→ Page
For T-slot	Standard						
	Screw-clamped, insertable in the slot from above	Magnetic Hall	SDBT-MSX	10 ... 30 V DC	PNP/NPN, switchable	N/O / N/C contact, switchable	–
	Insertable in the slot from above, flush with the cylinder profile	Magneto-resistive	SMT-8M-A	5 ... 30 V DC	PNP	N/O contact	–
						N/C contact	
					NPN	N/O contact	
					Non-contacting, 2-wire	N/O contact	
	Insertable in the slot from above, flush with the cylinder profile	Magnetic reed	SME-8M	5 ... 30 V AC/DC	Contacting, bipolar	N/O contact	–
						N/C contact	
	Insertable in the slot lengthwise, flush with the cylinder profile	Magnetic reed	SME-8	12 ... 30 V AC/DC	Contacting, bipolar	N/O contact	7
				3 ... 230 V AC/DC		N/C contact	11
	Insertable in the slot lengthwise	Magneto-resistive	SMT-8G	10 ... 30 V DC	PNP, NPN	N/O contact	–
		Magneto-resistive	SMT-8-SL	10 ... 30 V DC	PNP	N/O contact	–
		Magnetic reed	SME-8-SL	10 ... 30 V AC/DC	Contacting, bipolar	N/O contact	7
	With accessories	Magneto-resistive	SMT0-8E	10 ... 30 V DC	PNP	N/O contact	–
					NPN		
		Magnetic reed	SME0-8E	12 ... 30 V DC	Contacting, bipolar	N/O contact	–
			3 ... 250 V DC				
				3 ... 230 V AC			
	Corrosion-resistant						
	Insertable in the slot from above, flush with the cylinder profile	Magneto-resistive	CRSMT-8M	5 ... 30 V DC	PNP	N/O contact	–
	Welding-field-resistant						
	Insertable in the slot from above, screw-clamped	Magneto-resistive	SDBT-BSW	10 ... 30 V DC	PNP	N/O contact	–
					NPN		
Non-contacting, 2-wire							
With accessories	Magneto-inductive	SMTS0-8E	10 ... 30 V DC	PNP	N/O contact	–	
				NPN			
Heat-resistant up to 120°C							
Insertable in the slot lengthwise, flush with the cylinder profile	Magnetic reed	SME-8-...S6	0 ... 30 V AC/DC	Contacting, bipolar	N/O contact	11	
With accessories	Magnetic reed	SME0-8E-...S6	0 ... 30 V DC	Contacting	N/O contact	–	
			0 ... 30 V AC				
To EU Explosion Protection Directive (ATEX)							
Insertable in the slot from above, screw-clamped	Magneto-resistive	SDBT-MS-...EX6	8.2 V DC	NAMUR	NAMUR	–	

Product range overview

Design	Type of mounting	Measuring principle	Type	Operating voltage range	Switching output	Switching element function	→ Page
For C-slot	Standard						
	Insertable in the slot from above, flush with the cylinder profile	Magneto-resistive	SMT-10M	10 ... 30 V DC	PNP	N/O contact	C-slot
					NPN		
				Non-contacting, 2-wire			
		Magnetic reed	SME-10M	5 ... 30 V AC/DC	Contacting, bipolar	N/O contact	
Insertable in the slot lengthwise	Magneto-resistive	SMT-10G	10 ... 30 V DC	PNP	N/O contact		
	Magnetic reed	SME-10	12 ... 27 V AC/DC	Contacting	N/O contact		

T-slot switches can be used for drives with T-slot

Exceptions

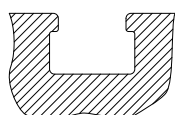

- DFM-B: SMT0-8E, SMTSO-8E, SME0-8E and SMP0-8E cannot be used
- DHDS: SME-8M can only be used on $\varnothing 50$
- DHPS: SME-8M can only be used on $\varnothing 20 \dots 35$
- HGDD-63-A: SMT-8M-A cannot be used
- HGPT-B: only SMT-8G can be used from size 40 and upwards
- SDBT-BSW- ... -PU/NU can only be used on a limited number of drive series. Page → 53

C-slot switches can be used for drives with C-slot

Exceptions

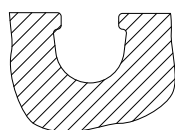

- ADVC $\varnothing 100$: SMT-10M and SME-10M cannot be used (ADVC has a T-slot and C-slot)
- DSM/DSM-B-6/8/10: SME-10M cannot be used
- DSM/DSM-B-10/16: SMT-10M cannot be used
- HGPT-B: only SMT-10G can be used for sizes up to and including size 35

For drives with sensor rail: these are available with 2 cylinder barrel contours

Only T-slot switches CRSMT-8M, SMT-8M-A and SDBT-MS- ... -EX6 can be used, and only with the identified profile.

CRSMT-8M and SMT-8M-A can be used for all diameters; SDBT-MS- ... -EX6 cannot be used for diameters 40 and 50.

Example: DSBF

Example: CDC

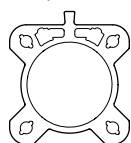

Suitable

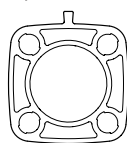

Not suitable

Peripherals overview

Mounting components and accessories		→ Page	Mounting components and accessories		→ Page
Proximity switches			Mounting kits and accessories		
[1]	SME-8-K-..., with cable	7	[7]	Mounting kit SMBR	14
[2]	SME-8-K-LED-230	11	[8]	Mounting kit CRSMB, corrosion-resistant	15
[3]	SME-8-SL-..., with plug	7	[9]	Mounting kit SMB-8-FENG	15
[4]	SME-8-S-..., with cable and plug	7	[10]	Sensor bracket DASP-M4-...	16
			[15]	Sensor tester SM-TEST-1	17
			-	Positioning element SMM-8	16
			-	Clip SMBK-8	17
			-	Inscription label ASLR	17
			-	Safety clip NEAU	17
Connecting cables			Drives		
[5]	NEBU-M...G...	17	[11]	Drives with T-slot	-
[6]	NEBU-M...W...	17	[12]	Round cylinders	-
			[13]	Standards-based cylinders DSBC	-
			[14]	Drives with tie or mounting rod	-

Type codes

001	Series
SME	Proximity sensor
002	Design type
8	For T-slot
003	Sensor version
	Inserted in the slot lengthwise
SL	Inserted in the slot lengthwise, sturdy due to long guides
004	Switching output
	None
O	N/C contact, 3-wire
ZS	2-wire PNP N/O contact
005	Switching status indication
	None
LED	Yellow LED

006	Rated operating voltage
24	24 V DC
230	230 V AC
007	Cable characteristic
	None
K	Standard/suitable for energy chains
008	Cable length [m]
5,0	5.0 m
7,5	7.5 m
009	Electrical connection
OE	Open end
SL	Plug

Data sheet – Magnetic reed

Function

N/O contact, with cable, 3-wire

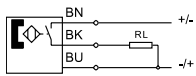

N/O contact, with plug

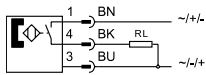

- Magnetic reed measuring principle
- Insertable in the slot lengthwise

SME-8-SL

- Sturdy thanks to long guides
- Plug directly on sensor

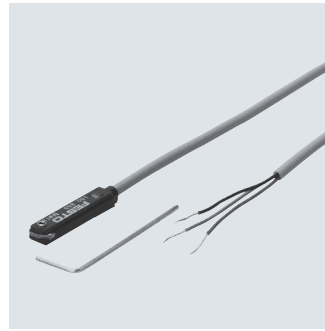

General technical data		SME-8-K	SME-8-S	SME-8-ZS	SME-8-O	SME-8-SL
Type						
Design		For T-slot				
Conforms to standard		EN 60947-5-2				
Certification		RCM compliance mark				
CE marking (see declaration of conformity)		To EU EMC Directive ¹⁾				
Note on materials		Free of copper and PTFE				
		RoHS-compliant	–	RoHS-compliant		

1) For information about the area of use, see the EC declaration of conformity at: www.festo.com/sp → Certificates.

If the devices are subject to usage restrictions in residential, commercial or light-industrial environments, further measures for the reduction of the emitted interference may be necessary.

Input signal/measuring element		SME-8-K	SME-8-K5	SME-8-K-7.5	SME-8-S	SME-8-ZS	SME-8-O	SME-8-SL
Type								
Measuring principle		Magnetic reed						
Ambient temperature	[°C]	–40 ... +60	–40 ... +70	–40 ... +70	–40 ... +70	–40 ... +60	–40 ... +60	–40 ... +60

Switching output		SME-8-K	SME-8-S	SME-8-ZS	SME-8-O	SME-8-SL
Type						
Switching output		Contacting, bipolar				
Switching element function		N/O contact	N/O contact	N/O contact	N/C contact	N/O contact
Reproducibility of switching value	[mm]	±0.1	±0.1	±0.1	±0.1	±0.1
Switch-on time	[ms]	≤ 0.5	≤ 0.5	≤ 0.5	≤ 2	≤ 0.6
Switch-off time	[ms]	≤ 0.03	≤ 0.03	≤ 0.03	≤ 0.2	≤ 0.05
Max. switching frequency	[Hz]	800	–	800	–	500
Max. output current	[mA]	500	500	80	50	500
Max. switching capacity AC	[VA]	10	10	–	1.5	10
Max. switching capacity DC	[W]	10	10	2.16	1.5	10
Voltage drop	[V]	0	–	≤ 3.5	≤ 2.5	0

Output, additional data	
Short circuit protection	No
Overload protection	Not present

Electronics		SME-8-K	SME-8-S	SME-8-ZS	SME-8-O	SME-8-SL
Type						
Operating voltage range	[V AC]	12 ... 30	12 ... 30	–	12 ... 30	10 ... 30
Operating voltage range	[V DC]	12 ... 30	12 ... 30	12 ... 27	12 ... 30	10 ... 30
Reverse polarity protection		No				

Data sheet – Magnetic reed

Electromechanics							
Type	SME-8-K	SME-8-K5	SME-8-K-7.5	SME-8-S	SME-8-ZS	SME-8-O	SME-8-SL
Electrical connection	Cable, 3-wire			Cable with plug M8x1, 3-pin	Cable, 2-wire	Cable, 3-wire	Plug M8x1, 3-pin
Outlet direction of connection	In-line						
Cable length [m]	2.5	5	7.5	0.3	2.5	7.5	–
Information on materials: cable sheath	TPE-U (PUR)						–

Mechanics							
Type	SME-8-K	SME-8-K5	SME-8-K-7.5	SME-8-S	SME-8-ZS	SME-8-O	SME-8-SL
Type of mounting	Clamped in T-slot Insertable in the slot lengthwise						
Information on materials: housing	Epoxy resin PC PET High-alloy stainless steel						

Display/operation	
Switching status indication	Yellow LED

Immission/emission							
Type	SME-8-K	SME-8-K5	SME-8-K-7.5	SME-8-S	SME-8-ZS	SME-8-O	SME-8-SL
Ambient temperature with flexible cable installation [°C]	–5 ... +60	–5 ... +70	–5 ... +70	–5 ... +70	–5 ... +60	–5 ... +60	–
Degree of protection	IP65 IP67			– IP67	IP65 IP67	– IP67	IP65 IP67
Insulation voltage [V]	50						
Surge resistance [kV]	3	3	3	3	3	3	3
Pollution degree	3						

Pin allocation to EN 60947-5-2			
Plug, 3-pin M8x1	Pin	Wire colour	Allocation
	1	Brown	+
	3	Blue	–
	4	Black	Output

Data sheet – Magnetic reed

Dimensions

Download CAD data → www.festo.com

N/O contact, cable

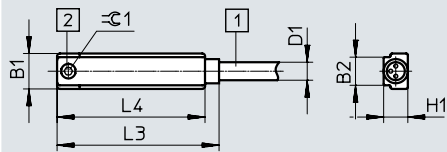

- [1] Connecting cable, 3-wire cable, 3 x 0.14 mm²
- [2] Yellow light emitting diode
- [3] Max. tightening torque 0.2 Nm

Type	B1	B2	D1 ∅	H1	L3	L4	±0.1
SME-8-K- ...	6.4	5	2.9	4.3	28.8	26.3	1.3

Dimensions

Download CAD data → www.festo.com

N/C contact, cable

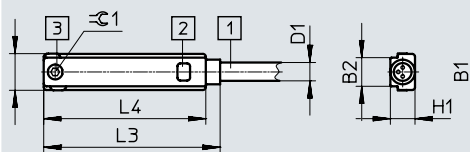

- [1] Connecting cable, 3-wire cable, 3 x 0.14 mm²
- [2] Yellow light emitting diode
- [3] Max. tightening torque 0.2 Nm

Type	B1	B2	D1 ∅	H1	L3	L4	±0.1
SME-8-O-K-LED-24	6.4	5	2.9	4.4	30.8	28.3	1.3

Dimensions

Download CAD data → www.festo.com

Plug M8x1

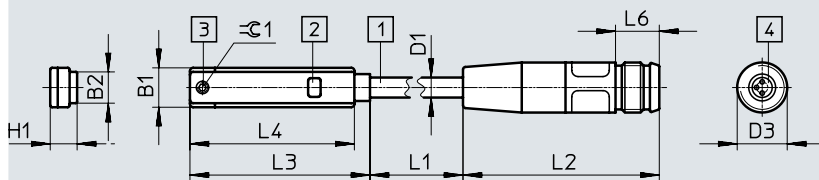



- [1] Connecting cable
- [2] Yellow light emitting diode
- [3] Clamping element
- [4] Plug to fit connecting cable NEBU-M8

L1 Cable length

Type	B1	B2	D1 ∅	D3	H1	L2 +5	L3	L4	L6 min.	±0.1
SME-8-S-LED-24	6.3	5	2.9	M8	4.7	31	28.8	26.3	6	1.3

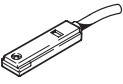
Data sheet – Magnetic reed

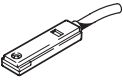
Ordering data							
	Switching output	Electrical connection			Cable length [m]	Part no.	Type
		Cable	Cable with plug M8x1	Plug M8x1			
N/O contact, basic version							
	Contacting, bipolar	3-wire	–	–	2.5	150855	SME-8-K-LED-24
			–	–	5.0	175404	SME-8-K5-LED-24
			–	–	7.5	530491	SME-8-K-7.5-LED-24
	–	3-pin	–	0.3	150857	SME-8-S-LED-24	
	Contacting, bipolar	–	–	–	2.5	171169	SME-8-ZS-KL-LED-24
			–	3-pin	–	526622	SME-8-SL-LED-24
N/C contact							
	Contacting, bipolar	3-wire	–	–	7.5	160251	SME-8-O-K-LED-24

Data sheet – Magnetic reed

Function

N/O contact, with cable, 2-wire

0...30 V AC/DC

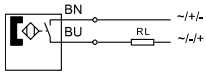

N/O contact, with cable, 2-wire

3...230 V AC/DC

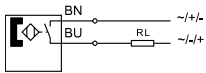

- Magnetic reed measuring principle
- Insertable in the slot lengthwise
- Heat-resistant design
- Variants with operating voltage range up to 230 V DC/AC

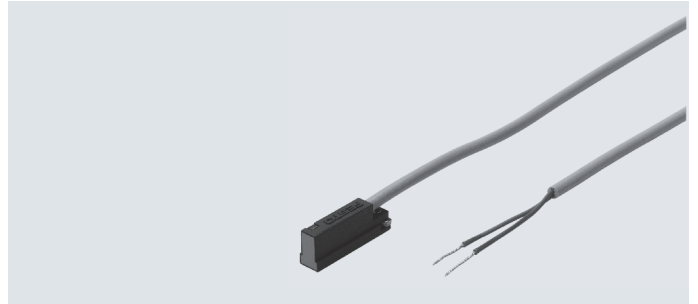

General technical data	SME-8...S6	SME-8...230
Design	For T-slot	
Conforms to standard	EN 60947-5-2	
Certification	–	RCM compliance mark
	–	CCC
CE marking (see declaration of conformity)	–	To EU EMC Directive ¹⁾
	–	To EU Low Voltage Directive
Note on materials	Free of copper and PTFE	
	RoHS-compliant	

1) For information about the area of use, see the EC declaration of conformity at: www.festo.com/sp → Certificates.

If the devices are subject to usage restrictions in residential, commercial or light-industrial environments, further measures for the reduction of the emitted interference may be necessary.

Input signal/measuring element	SME-8...S6	SME-8...230
Measuring principle	Magnetic reed	
Ambient temperature [°C]	–40 ... +120	–30 ... +60

Switching output	SME-8...S6	SME-8...230
Switching output	Contacting, bipolar	
Switching element function	N/O contact	
Reproducibility of switching value [mm]	±0.1	±0.1
Switch-on time [ms]	≤ 0.5	2
Switch-off time [ms]	≤ 0.03	0.03
Max. switching frequency [Hz]	800	500
Max. output current [mA]	500	120
Max. switching capacity AC [VA]	10	
Max. switching capacity DC [W]	10	
Voltage drop [V]	≤ 0	≤ 3.9
Off-state current [mA]	–	0

Data sheet – Magnetic reed

Output, additional data		
	SME-8-...-S6	SME-8-...-230
Short circuit protection	No	
Overload protection	Not present	
Electronics		
	SME-8-...-S6	SME-8-...-230
Operating voltage range [V AC]	0 ... 30	3 ... 230
Operating voltage range [V DC]	0 ... 30	3 ... 230
Reverse polarity protection	No	
Electromechanics		
	SME-8-...-S6	SME-8-...-230
Electrical connection	Cable, 2-wire, open end	
Outlet direction of connection	In-line	
Cable length [m]		2.5
Information on materials: cable sheath	TPE-S	TPE-U (PUR)
Mechanics		
	SME-8-...-S6	SME-8-...-230
Type of mounting	Clamped in T-slot	
	Insertable in the slot lengthwise	
Information on materials: housing	Epoxy resin	
	PET	
	High-alloy stainless steel	
Information on materials: cable sheath	TPE-S	TPE-U (PUR)
Display/operation		
	SME-8-...-S6	SME-8-...-230
Switching status indication	–	Yellow LED
Immission/emission		
	SME-8-...-S6	SME-8-...-230
Ambient temperature with flexible cable installation [°C]	–5 ... +120	–5 ... +60
Ambient temperature	–40 ... +120	–
Degree of protection	–	–
	IP67	IP68
Insulation voltage [V]	50	–
Surge resistance [kV]	0.8	4
Pollution degree	3	3

Data sheet – Magnetic reed

Dimensions

Download CAD data → www.festo.com

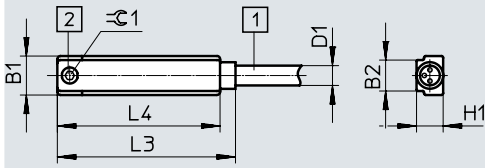

- [1] Connecting cable, 3-wire cable, 3 x 0.14 mm²
- [2] Max. tightening torque 0.2 Nm

Type	B1	B2	D1 ∅	H1	L3	L4	$\varnothing 1$
	±0.05	-0.08	±0.05...-0.1	-0.1		+0.2	
SME-8-...-S6	6.4	5	2.9	4.3	28.8	26.3	1.3

Dimensions

Download CAD data → www.festo.com

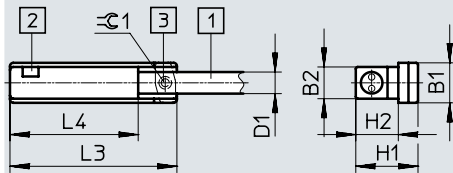

- [1] Connecting cable
- [2] Yellow light emitting diode
- [3] Max. tightening torque 0.2 Nm

Type	B1	B2	D1 ∅	H1	H2	L3	L4	$\varnothing 1$
SME-8-K-LED-230	6.4	5	3.4	9.8	6.7	26.2	20.2	1.3

Ordering data

	Switching output	Electrical connection	Outlet direction of connection	Cable length	Weight	Part no.	Type
		Cable		[m]	[g]		
N/O contact, heat-resistant							
	Contacting, bipolar	2-wire, open end	In-line	2.5	50	161756	SME-8-K-24-S6
N/O contact, operating voltage range up to 230 V AC/DC							
	Contacting, bipolar	2-wire, open end	In-line	2.5	39	152820	SME-8-K-LED-230

Accessories

Mounting kit SMBR

Material:
Polyacetal
RoHS-compliant

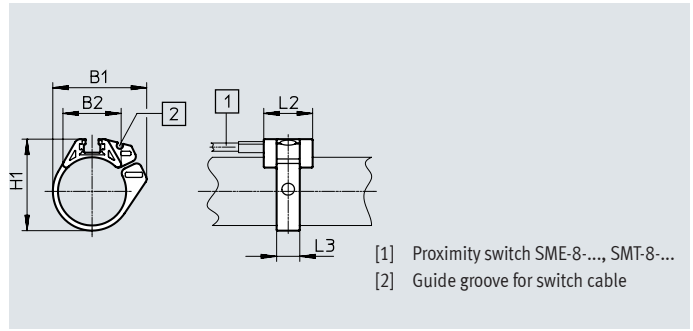

Dimensions and ordering data

For piston \varnothing	B1	B2	H1	L2	L3	Part no.	Type
8	18.9	12.3	17.5	19	7	175091	SMBR-8-8
10	20.4	13.7	19.9	19	7	175092	SMBR-8-10
12	22.7	14.3	21.9	19	7	★ 175093	SMBR-8-12
16	28.2	16.9	25.7	19	8	★ 175094	SMBR-8-16
20	34.5	20.8	30.4	19	9	★ 175095	SMBR-8-20
25	36.7	22.7	35.6	19	9	★ 175096	SMBR-8-25
32	41.7	24.6	42.7	19	9	175097	SMBR-8-32
40	47.1	26.5	50.7	19	9	175098	SMBR-8-40
50	56.4	28.6	61.5	19	9	175099	SMBR-8-50
63	69.4	32	74.5	19	9	175100	SMBR-8-63

Accessories

Mounting kit CRSMB

Design: for round cylinders

Type of mounting: any

Type of mounting: glued

Degree of protection: IP65, IP68, IP69K

Ambient temperature: -40 ... +90°C

Material:

Housing: anodised aluminium,
TPE-U(PU)

Free of copper and PTFE

RoHS-compliant

PWIS conformity:

VDMA24364-B2-L

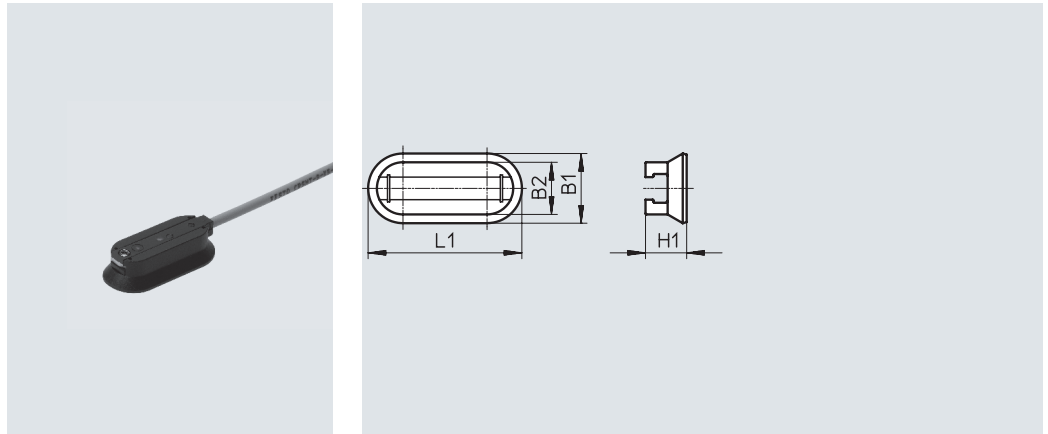

Ordering data									
For piston \varnothing	B1	B2	H1	L1	CRC ¹⁾	Part no.	Type		
32 ... 100	15.8	11.8	9.3	35	4	525565	CRSMB-8-3 2/100		

1) Corrosion resistance class CRC 4 to Festo standard FN 940070

Particularly high corrosion stress. Outdoor exposure under extreme corrosive conditions, e.g. in the chemical or food industries. Such applications may need to be safeguarded by means of special testing (→ also FN 940082), using appropriate media.

Mounting kit

SMB-8-FENG

Material:

Wrought aluminium alloy

Free of copper and PTFE

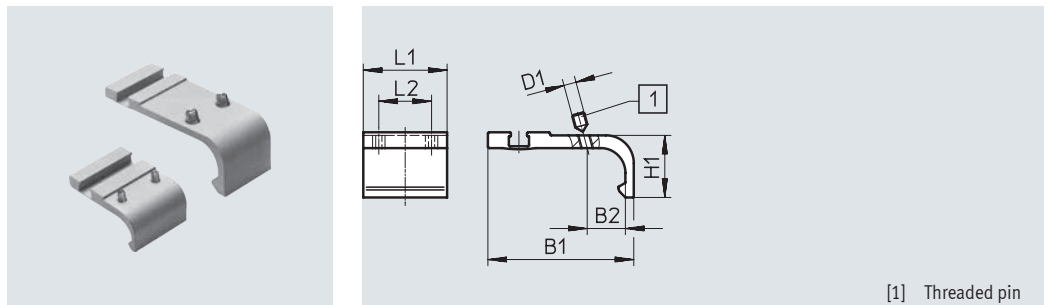

[1] Threaded pin

Dimensions and ordering data									
For piston \varnothing	B1	B2	D1	H1	L1	L2	Tightening torque [Nm]	Part no.	Type
32/40	35.1	8.7	M3	15.5	27	17	0.2	175705	SMB-8-FENG-3 2/40
50/63	47	12.3	M4	20	27	17	0.5	175706	SMB-8-FENG-50/63
80/100	64.3	15.7	M5	24.3	27	17	0.7	175707	SMB-8-FENG-80/100

Accessories

Positioning element SMM

Insertable in the slot lengthwise

Ambient temperature: -40 ... +120°C

Materials:

Housing: anodised wrought aluminium alloy

Screws: high-alloy stainless steel

Note on materials: RoHS-compliant

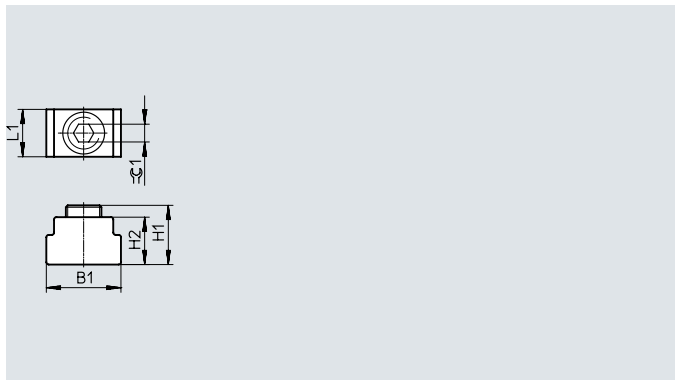
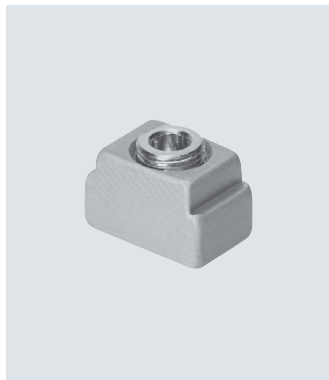

Dimensions and ordering data								
B1	H1	H2	L1	$\approx \varnothing 1$	CRC ¹⁾	Part no.	Type	PU ²⁾
6.3	5.0	4.0	4.0	1.5	3	547941	SMM-8	10

1) Corrosion resistance class CRC 3 to Festo standard FN 940070

High corrosion stress. Outdoor exposure under moderate corrosive conditions. Externally visible parts with primarily functional surface requirements which are in direct contact with a normal industrial environment.

2) Packaging unit

Sensor bracket DASP-M4-...-A

Material:

Anodised wrought aluminium alloy

Screws: high-alloy stainless steel

RoHS-compliant

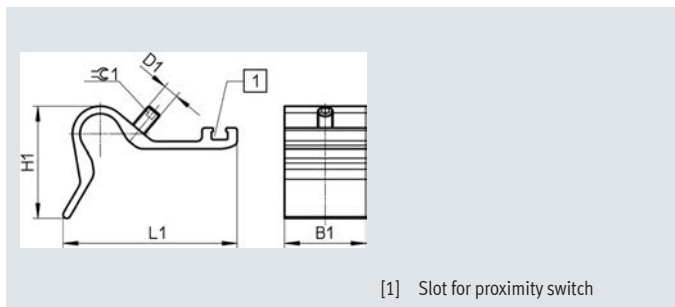







[1] Slot for proximity switch

Dimensions and ordering data										
Type	B1	D1	H1	L1	$\approx \varnothing 1$	Tightening torque [Nm]	CRC ¹⁾	Weight [g]	Part no.	Type
DASP-M4-125-A	32.5	M5	28	45.4	2.5	1	3	26.5	1451483	DASP-M4-125-A
DASP-M4-160-A	32.5	M6	44.7	69.4	3	1	3	41.5	1553813	DASP-M4-160-A
DASP-M4-250-A	32.5	M6	56.3	88	3	1	3	60	1456781	DASP-M4-250-A
DASP-M4-320-A	32.5	M6	56.3	88	3	1	3	60	3015256	DASP-M4-320-A

1) Corrosion resistance class CRC 3 to Festo standard FN 940070

High corrosion stress. Outdoor exposure under moderate corrosive conditions. Externally visible parts with primarily functional surface requirements which are in direct contact with a normal industrial environment.

Accessories

Ordering data – Connecting cables		Number of wires	Cable length [m]	Part no.	Type	Data sheets → Internet: nebu/sim
Socket M8x1, 3-pin						
	For SMT/SME-8... and SMTO/SMTSO/SME0-8E	3	2.5	★ 541333	NEBU-M8G3-K-2.5-LE3	
			5	★ 541334	NEBU-M8G3-K-5-LE3	
	For SMT/SME-8... and SMTO/SMTSO/SME0-8E	3	2.5	★ 541338	NEBU-M8W3-K-2.5-LE3	
			5	★ 541341	NEBU-M8W3-K-5-LE3	
Socket M12x1, 5-pin						
	For SMT/SME-8M and SMTO/SMTSO/SME0-8E	3	2.5	★ 541363	NEBU-M12G5-K-2.5-LE3	
			5	★ 541364	NEBU-M12G5-K-5-LE3	
	For SMT/SME-8M and SMTO/SMTSO/SME0-8E	3	2.5	541367	NEBU-M12W5-K-2.5-LE3	
			5	541370	NEBU-M12W5-K-5-LE3	
Socket M12x1, resistant to welding spatter						
	For SDBT and SMTSO	3	3	30450	SIM-M12-RS-3GD-3	
	For SDBT and SMTSO	3	3	30451	SIM-M12-RS-3WD-3	

Ordering data – Safety clip for ATEX zone		Size	Description	Part no.	Type	PU ¹⁾
	M8	<ul style="list-style-type: none"> Protects "equipment that is not intrinsically safe" in zones 2 and 22 against simple disconnection ATEX category: gas: II 3G / dust: II 3D 	548067	NEAU-M8-GD	1	
	M12		548068	NEAU-M12-GD	1	

1) Packaging unit

Ordering data – Mounting components		Description	Part no.	Type
		For fixing connecting cables in place	534254	SMBK-8

Ordering data – Sensor tester		Description	Part no.	Type
		<ul style="list-style-type: none"> Testing the functionality of proximity switches using the integrated voltage supply Adjusting proximity switches on the cylinder 	158481	SM-TEST-1

Ordering data – Inscription labels		Size	Part no.	Type	PU ¹⁾
		23x4 mm	541598	ASLR-L-423	34

1) Packaging unit

Festo - Your Partner in Automation



1 Festo Inc.
5300 Explorer Drive
Mississauga, ON L4W 5G4
Canada

Festo Customer Interaction Center
Tel: 1 877 463 3786
Fax: 1 877 393 3786
Email: customer.service.ca@festo.com

2 Festo Pneumatic
Av. Ceylán 3,
Col. Tequesquináhuac
54020 Tlalnepantla,
Estado de México

Multinational Contact Center
01 800 337 8669
ventas.mexico@festo.com

3 Festo Corporation
1377 Motor Parkway
Suite 310
Islandia, NY 11749

Festo Customer Interaction Center
1 800 993 3786
1 800 963 3786
customer.service.us@festo.com

4 Regional Service Center
7777 Columbia Road
Mason, OH 45040

Connect with us



www.festo.com/socialmedia



www.festo.com

Subject to change