







- Electrically or pneumatically actuated valves
- Valves with internal or external pilot air
- Manifold mounting for 2 ... 10 valves or individual mounting

# Solenoid/pneumatic valves, midi pneumatics

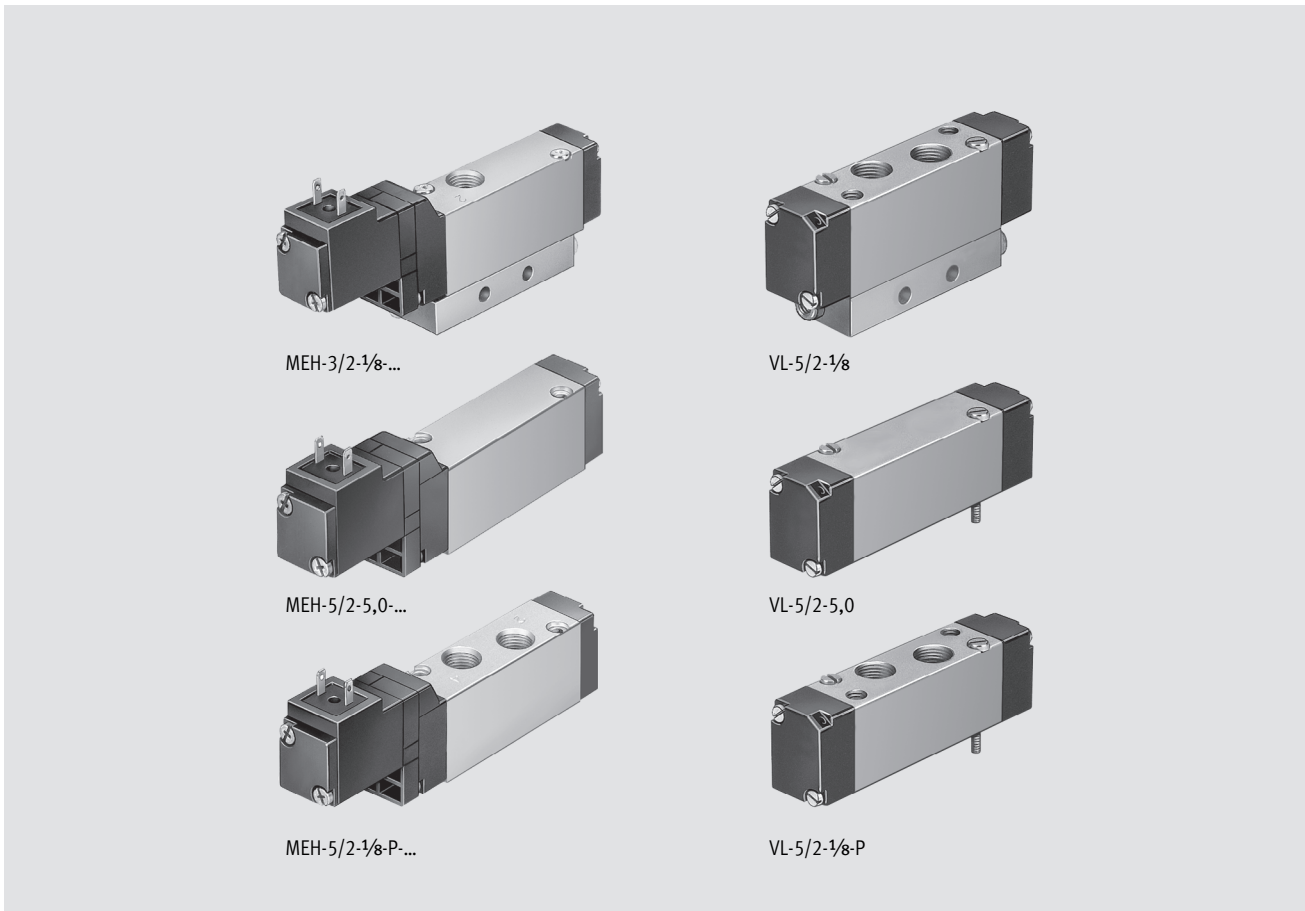
Features

FESTO



Parameter	Variants	Possible combinations	Mounting
<p>-  - Flow rate 200 ... 700 l/min</p>	<ul style="list-style-type: none"> <li>Electrically and pneumatically actuated valves</li> <li>3/2, 5/2 and 5/3-way valves</li> </ul>	<ul style="list-style-type: none"> <li>Any number of valves can be added with series sub-bases</li> <li>2 ... 10 manifold mounted valves with blanking plates for spare positions</li> <li>Prefabricated plug socket with cable, LED and protective circuit</li> <li>Cable and solenoid coil for assembly by user</li> <li>Manual override</li> </ul>	<p>Semi in-line valves, threaded</p> <ul style="list-style-type: none"> <li>Individual mounting</li> </ul> <p>Sub-base valves</p> <ul style="list-style-type: none"> <li>Sub-base</li> <li>Series sub-base</li> </ul> <p>Valves with in-line connection at top</p> <ul style="list-style-type: none"> <li>PRS manifold</li> </ul>
<p>-  - Width 18 mm</p>	<ul style="list-style-type: none"> <li>Sub-base valves</li> <li>Semi in-line valves</li> </ul>		
<p>-  - Voltage 24 V DC 110 or 230 V AC</p>			

# Solenoid/pneumatic valves, midi pneumatics

Features

## Mounting options

Individual sub-base

Connection at side

AS-ME-1/8

AS-VL-1/8

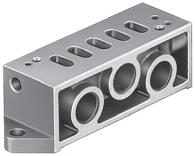

Connection underneath

AU-ME-1/8



Manifold mounting

Series sub-base

AW-ME-1/8



AW-VL-1/8

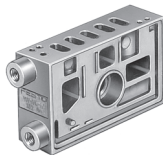

Intermediate plate

ZP-ME-1/8



End plate kit

EP-ME-1/8



Blanking plate for spare positions

PRMEB-5



In-line manifold

PRS-ME-1/8

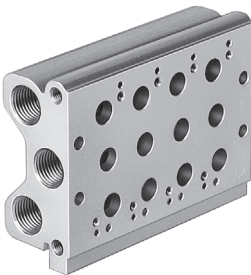

Blanking plate for spare positions

PRSB-ME-1/8

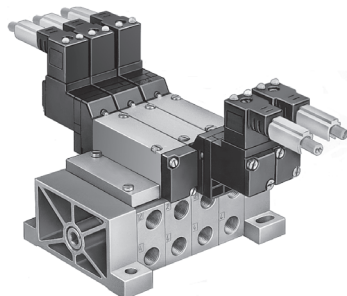
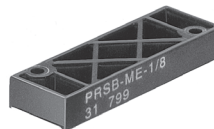

# Solenoid valves MEH/MEBH, midi pneumatics

Overview – Solenoid valves

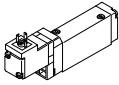
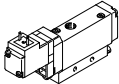
Function	Design	Type	Nominal flow rate [l/min]	Pneumatic connection	Operating voltage		Semi in-line valve	Sub-base valve
					[V DC]	[V AC]		
3/2-way valves		MEBH-3/2-...	700	5.0 mm	24	110, 230	-	■
			600	G1/8			■	-
		MOEBH-3/2-...	700	5.0 mm	24	110, 230	-	■
			600	G1/8			■	-
		MEH-3/2-...	700	5.0 mm	24	-	-	■
			600	G1/8			■	-
		MOEH-3/2-...	700	5.0 mm	24	-	-	■
			600	G1/8			■	-

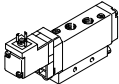
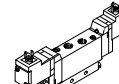
Function	Design	Type	Nominal flow rate [l/min]	Pneumatic connection	Operating voltage		Semi in-line valve	Sub-base valve
					[V DC]	[V AC]		
5/2-way valves		MEBH-5/2-...	700	5.0 mm	24	110, 230	-	■
			600	G1/8			■	-
		MEH-5/2-...	700	5.0 mm	24	-	-	■
			600	G1/8			■	-
		JMEBH-5/2-...	700	5.0 mm	24	110, 230	-	■
			650	G1/8			■	-
		JMEH-5/2-...	700	5.0 mm	24	-	-	■
			650	G1/8			■	-

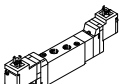
Function	Design	Type	Nominal flow rate [l/min]	Pneumatic connection	Operating voltage		Semi in-line valve	Sub-base valve
					[V DC]	[V AC]		
5/3-way valves		MEBH-5/3...	500	5.0 mm	24	110, 230	-	■
			600	G1/8			■	-
			400	5.0 mm			-	■
			300	G1/8			■	-
			400	5.0 mm			-	■
			200	G1/8			■	-
		MEH-5/3...	500	5.0 mm	24	-	-	■
			600	G1/8			■	-
			400	5.0 mm			-	■
			300	G1/8			■	-
			400	5.0 mm			-	■
			200	G1/8			■	-

# Solenoid valves MEH/MEBH, midi pneumatics

Overview – Solenoid valves



Type	Pilot air supply		Type of reset		Normal position		→ Page/Internet
	internal	external	pneumatic spring	mechanical spring	closed	open	
<b>Solenoid valve</b>							
MEBH-3/2-...	■	-	-	■	■	-	9
MOEBH-3/2-...	■	-	-	■	-	■	
MEH-3/2-...	■	-	-	■	■	-	21
MOEH-3/2-...	■	-	-	■	-	■	

Type	Pilot air supply		Type of reset		Normal position		→ Page/Internet
	internal	external	pneumatic spring	mechanical spring	closed	open	
<b>Solenoid valve</b>							
MEBH-5/2-...	■	■	■	■	-	-	9
MEH-5/2-...	■	■	■	■	-	-	21
<b>Double solenoid valve</b>							
JMEBH-5/2-...	■	■	-	-	-	-	9
JMEH-5/2-...	■	■	-	-	-	-	21

Type	Pilot air supply		Type of reset		Normal position			→ Page/Internet
	internal	external	pneumatic spring	mechanical spring	closed	exhausted	pressurised	
<b>Solenoid valve</b>								
MEBH-5/3...	■	■	-	■	■	-	-	9
	■	■	-	■	-	■	-	
	■	■	-	■	-	-	■	
MEH-5/3...	■	■	-	■	■	-	-	21
	■	■	-	■	-	■	-	
	■	■	-	■	-	-	■	

# Pneumatic valves VL/J, midi pneumatics

Overview – Pneumatic valves

Function	Design	Type	Nominal flow rate [l/min]	Pneumatic connection	Semi in-line valve	Sub-base valve
5/2-way valves	Pneumatic valve					
		VL-5/2-...	700	5.0 mm	-	■
			600	G $\frac{1}{8}$	■	-
	Double pilot valve					
		J-5/2-...	700	5.0 mm	-	■
			650	G $\frac{1}{8}$	■	-

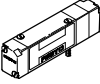
Function	Design	Type	Nominal flow rate [l/min]	Pneumatic connection	Semi in-line valve	Sub-base valve
5/3-way valves	Pneumatic valve					
		VL-5/3...	600	5.0 mm	-	■
			500	G $\frac{1}{8}$	■	-
			350	5.0 mm	-	■
			350	G $\frac{1}{8}$	■	-
			300	5.0 mm	-	■
			300	G $\frac{1}{8}$	■	-

# Pneumatic valves VL/J, midi pneumatics

Overview – Pneumatic valves

Type	Pilot air supply		Type of reset		→ Page/Internet
	internal	external	pneumatic spring	mechanical spring	
<b>Pneumatic valve</b>					
VL-5/2-...	■	-	-	■	34
<b>Double pilot valve</b>					
J-5/2-...	■	-	-	-	34

Type	Pilot air supply		Normal position			→ Page/Internet
	internal	external	closed	exhausted	pressurised	
<b>Pneumatic valve</b>						
VL-5/3...	■	-	■	-	-	34
	■	-	-	■	-	
	■	-	-	-	■	

# Solenoid valves MEH/MEBH, midi pneumatics

Type codes

MEBH – 5/2 – 1/8 – P – L – B – 110AC

Type	
MEBH	Single solenoid, with EB solenoid coil
MOEBH	Single solenoid, with EB solenoid coil, normally open
MEH	Single solenoid, with E solenoid coil
MOEH	Single solenoid, with E solenoid coil, normally open
JMEBH	Double solenoid, with EB solenoid coil
JMEH	Double solenoid, with E solenoid coil

Valve function	
3/2	3/2-way valve
5/2	5/2-way valve
5/3	5/3-way valve

Normal position	
G	Closed
E	Exhausted
B	Pressurised

Design, pneumatic connection/nominal size	
1/8	Semi in-line valve, thread G1/8
5.0	Sub-base valve, 5 mm

Mounting method	
P	On manifold PRS-ME

Type of reset	
	Mechanical spring
L	Pneumatic spring

Pilot air supply	
	Internal
S	External

Generation	
B	B series

  

Operating voltage	
	24 V DC
110AC	110 V AC
230AC	230 V AC



# Solenoid valves MEBH, midi pneumatics

Technical data

-  - Flow rate  
200 ... 700 l/min

-  - Voltage  
24 V DC  
110/230 V AC

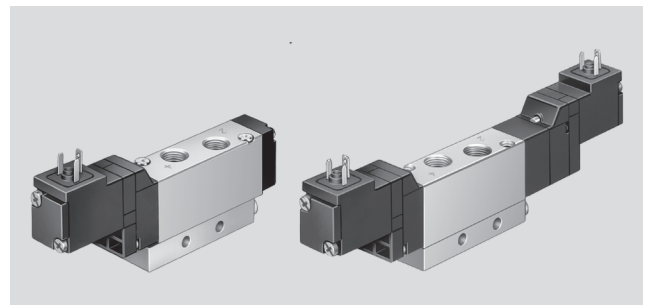

General technical data							
Type		MEBH-3/2-... MOEBH-3/2-...	MEBH-5/2-...	JMEBH-5/2-...	MEBH-5/3...		
Design		Piston spool					
Type of mounting	...-1/8	2 through-holes					
	...-5.0	On sub-base with two M3 screws					
	...-1/8-P	On manifold with two M3 screws					
Pneumatic connection	...-1/8	G1/8					
	...-5.0	Sub-base					
	...-1/8-P	G1/8					
Lap		Overlap					
Nominal size	[mm]	5					
Standard nominal flow rate 1 > 2, 1 > 4					G	E	B
	...-1/8	600/500	600	650	600	300	200
	...-5.0	700/600	700	700	500	400	400
	...-1/8-P	600/500	600	650	650	300	200
Materials		Housing: Aluminium Seals: Nitrile rubber					
Weight	[g]						
	...-1/8	105	105	142	153		
	...-5.0	105	105	146	150		
...-1/8-P	105	105	142	153			

Operating and environmental conditions							
Type		MEBH-3/2-... MOEBH-3/2-...	MEBH-5/2-...	JMEBH-5/2-...	MEBH-5/3...		
Operating medium		Compressed air in accordance with ISO 8573-1:2010 [7:4:4] <sup>1)</sup>					
Note on operating/pilot medium		Operation with lubricated medium possible (in which case lubricated operation will always be required)					
Operating pressure range	Internal pilot air supply	[bar]	2 ... 8	2.5 ... 8	1.5 ... 8	3 ... 8	
	External pilot air supply	[bar]	-	-0.9 ... +10			
Pilot pressure range		[bar]	-	2.5 ... 8	1.5 ... 8	3 ... 8	
Ambient temperature		[°C]	-5 ... +50				
Temperature of medium		[°C]	-5 ... +50				
Note on materials		RoHS-compliant					

1) Only oils of viscosity class 32 may be used for lubricated operation.

## Solenoid valves MEBH, midi pneumatics

Technical data

Valve response times [ms]							
Type	MEBH-3/2-... MOEBH-3/2-...		MEBH-5/2-...		JMEBH-5/2-...	MEBH-5/3...	
Type of reset	mechanical	pneumatic	mechanical	pneumatic	–	mechanical	pneumatic
On	10	–	10	15	–	12	–
Off	28	–	28	18	–	25	–
Changeover	–	–	–	–	10	–	–

Electrical data			
EB solenoid coil			
Electrical connection			Plug, square design to EN 175301-803, type C
Operating voltage	D.C. voltage	[V DC]	24
	AC voltage	[V AC]	110/230 (50 ... 60 Hz)
Coil characteristics	D.C. voltage	[W]	1.5
	AC voltage	[VA]	2.4
Protection class to EN 60 529			IP65 (in combination with plug socket)

# Solenoid valves MEBH, midi pneumatics

Technical data – 3/2-way valves

## Dimensions

Download CAD data → [www.festo.com](http://www.festo.com)

Semi in-line valve with thread G1/8

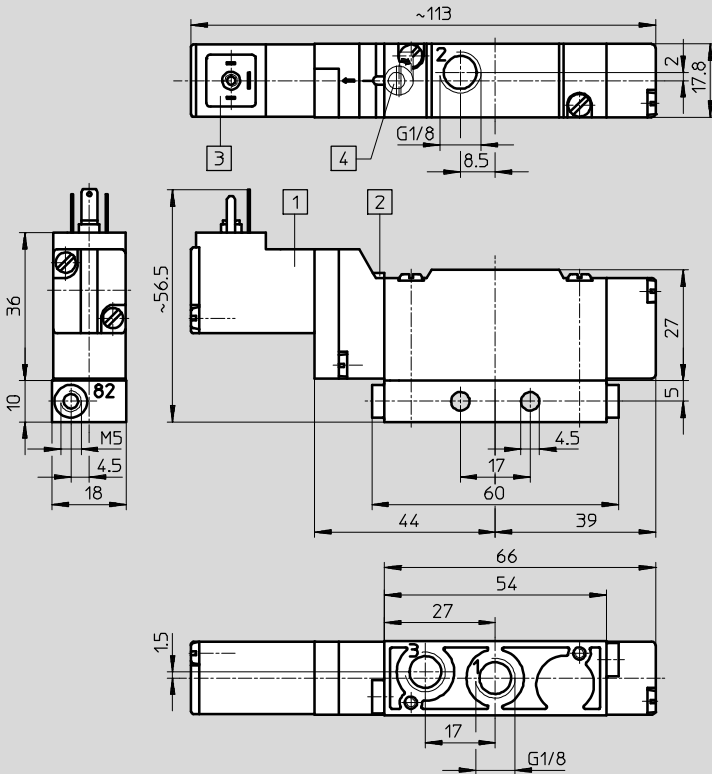

- 1 Solenoid coil can be rotated 180°<sup>1)</sup>
  - 2 Manual override
  - 3 Suitable for plug sockets to EN 175 301-803, form C: MSSD-EB or KMEB-...
  - 4 Manual override tool (accessory) AHB-ME-1/8
- 1) The seal must not be turned!

Semi in-line valve for manifold PRS-ME

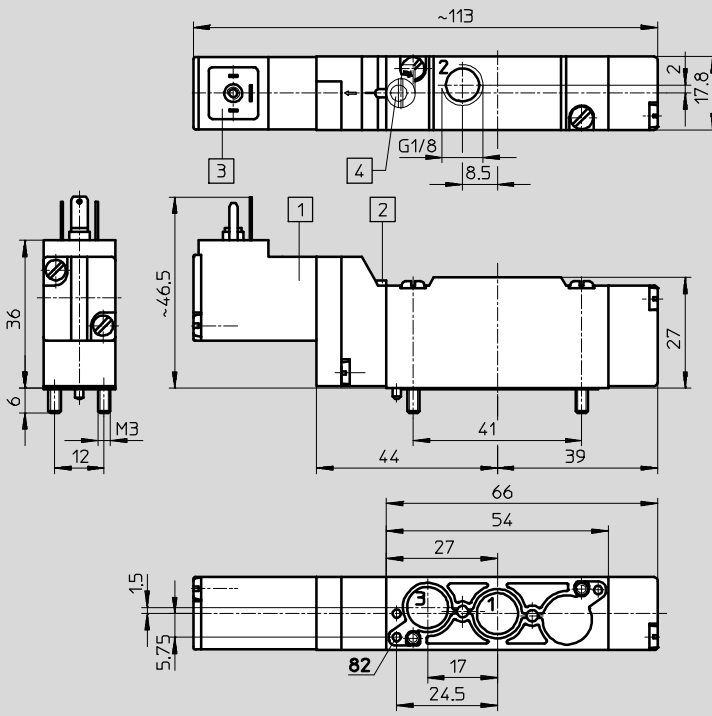

- 1 Solenoid coil can be rotated 180°<sup>1)</sup>
  - 2 Manual override
  - 3 Suitable for plug sockets to EN 175 301-803, form C: MSSD-EB or KMEB-...
  - 4 Manual override tool (accessory) AHB-ME-1/8
- 1) The seal must not be turned!

# Solenoid valves MEBH, midi pneumatics

Technical data – 3/2-way valves

FESTO

## Dimensions

Download CAD data → [www.festo.com](http://www.festo.com)

Sub-base valve

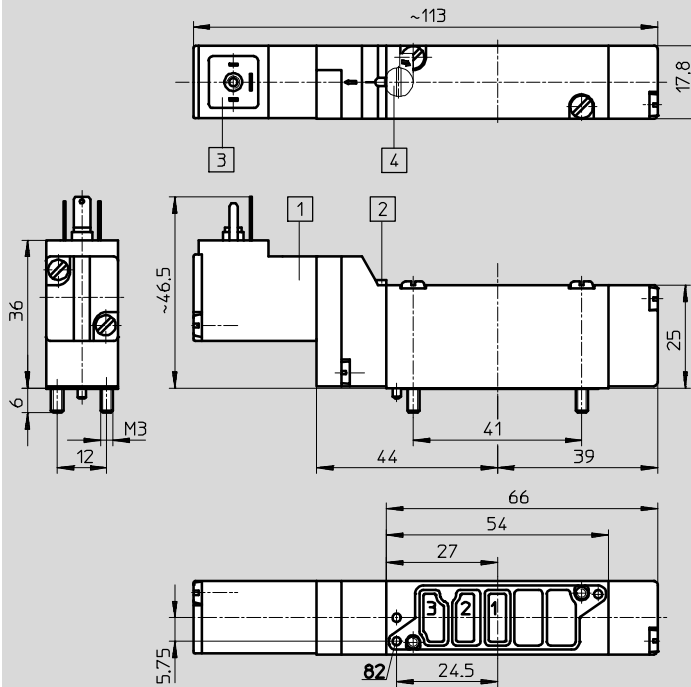

- 1) Solenoid coil can be rotated 180°<sup>1)</sup>
  - 2) Manual override
  - 3) Suitable for plug sockets to EN 175 301-803, form C: MSSD-EB or KMEB-...
  - 4) Manual override tool (accessory) AHB-ME-1/8
- 1) The seal must not be turned!

## Ordering data

Circuit symbol	Description	Voltage	Part No.	Type
<b>Normally closed</b>				
	Semi in-line valve with thread G1/8	24 V DC	172998	MEBH-3/2-1/8-B
		110 V AC	173042	MEBH-3/2-1/8-B-110AC
		230 V AC	173084	MEBH-3/2-1/8-B-230AC
	Semi in-line valve for manifold PRS-ME	24 V DC	173000	MEBH-3/2-1/8-P-B
		110 V AC	173056	MEBH-3/2-1/8-P-B-110AC
		230 V AC	173098	MEBH-3/2-1/8-P-B-230AC
	Sub-base valve	24 V DC	172999	MEBH-3/2-5,0-B
		110 V AC	173070	MEBH-3/2-5,0-B-110AC
		230 V AC	173112	MEBH-3/2-5,0-B-230AC
<b>Normally open</b>				
	Semi in-line valve with thread G1/8	24 V DC	173001	MOEBH-3/2-1/8-B
		110 V AC	173053	MOEBH-3/2-1/8-B-110AC
		230 V AC	173095	MOEBH-3/2-1/8-B-230AC
	Semi in-line valve for manifold PRS-ME	24 V DC	173003	MOEBH-3/2-1/8-P-B
		110 V AC	173067	MOEBH-3/2-1/8-P-B-110AC
	Sub-base valve	24 V DC	173002	MOEBH-3/2-5,0-B

# Solenoid valves MEBH, midi pneumatics

Technical data – 5/2-way valves

## Dimensions

Download CAD data → [www.festo.com](http://www.festo.com)

Semi in-line valve with thread G1/8

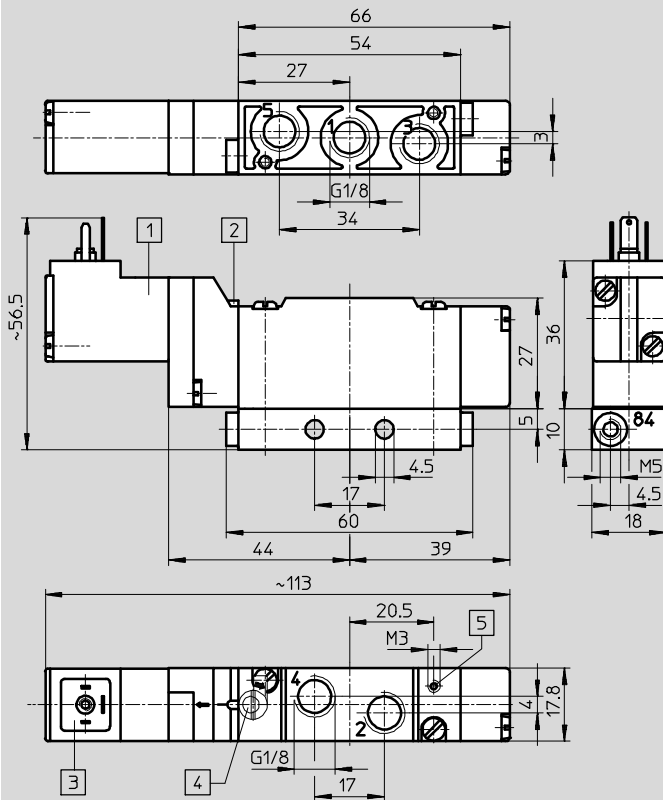

- 1 Solenoid coil can be rotated 180°<sup>1)</sup>
- 2 Manual override
- 3 Suitable for plug sockets to EN 175301-803, form C: MSSD-EB or KMEB-...
- 4 Manual override tool (accessory) AHB-ME-1/8
- 5 Port for external pilot air on S types

1) The seal must not be turned!

Semi in-line valve for manifold PRS-ME

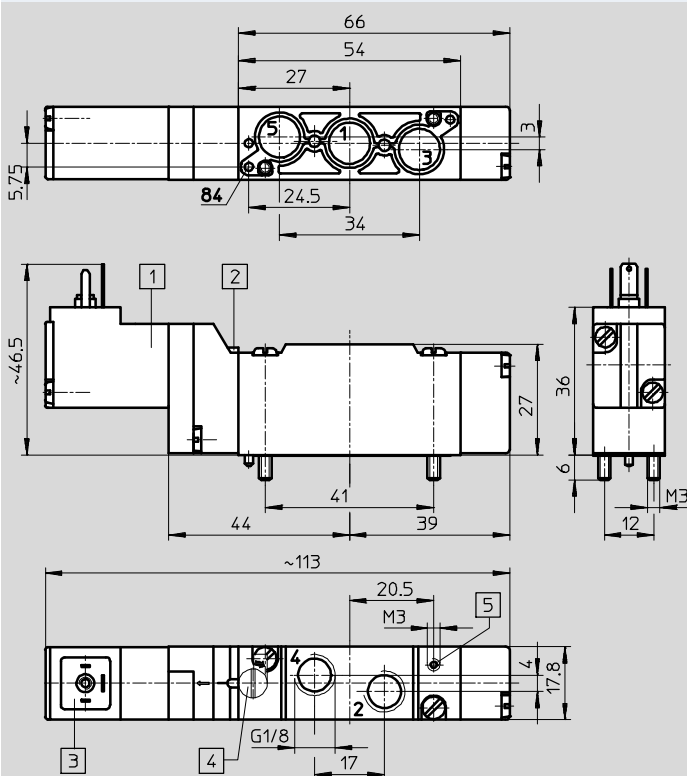

- 1 Solenoid coil can be rotated 180°<sup>1)</sup>
- 2 Manual override
- 3 Suitable for plug sockets to EN 175301-803, form C: MSSD-EB or KMEB-...
- 4 Manual override tool (accessory) AHB-ME-1/8
- 5 Port for external pilot air on S types

1) The seal must not be turned!

# Solenoid valves MEBH, midi pneumatics

Technical data – 5/2-way valves

## Dimensions

Download CAD data → [www.festo.com](http://www.festo.com)

Sub-base valve

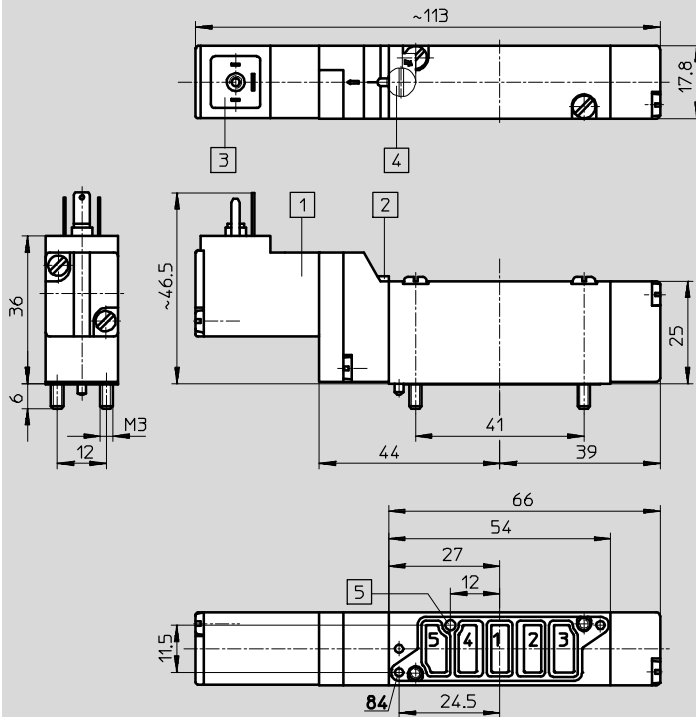

- 1 Solenoid coil can be rotated 180°<sup>1)</sup>
  - 2 Manual override
  - 3 Suitable for plug sockets to EN 175 301-803, form C: MSSD-EB or KMEB-...
  - 4 Manual override tool (accessory) AHB-ME-1/8
  - 5 Port for external pilot air on S types
- 1) The seal must not be turned!

# Solenoid valves MEBH, midi pneumatics

Technical data – 5/2-way valves

Ordering data				
Circuit symbol	Description	Voltage	Part No.	Type
<b>Mechanical spring return, internal pilot air supply</b>				
	Semi in-line valve with thread G1/8	24 V DC	173004	MEBH-5/2-1/8-B
		110 V AC	173043	MEBH-5/2-1/8-B-110AC
		230 V AC	173085	MEBH-5/2-1/8-B-230AC
	Semi in-line valve for manifold PRS-ME	24 V DC	173006	MEBH-5/2-1/8-P-B
		110 V AC	173057	MEBH-5/2-1/8-P-B-110AC
		230 V AC	173099	MEBH-5/2-1/8-P-B-230AC
	Sub-base valve	24 V DC	173005	MEBH-5/2-5,0-B
		110 V AC	173071	MEBH-5/2-5,0-B-110AC
		230 V AC	173113	MEBH-5/2-5,0-B-230AC
<b>Mechanical spring return, external pilot air supply</b>				
	Semi in-line valve with thread G1/8	24 V DC	173007	MEBH-5/2-1/8-S-B
		110 V AC	173046	MEBH-5/2-1/8-S-B-110AC
		230 V AC	173088	MEBH-5/2-1/8-S-B-230AC
	Semi in-line valve for manifold PRS-ME	24 V DC	173009	MEBH-5/2-1/8-P-S-B
		110 V AC	173060	MEBH-5/2-1/8-P-S-B-110AC
		230 V AC	173102	MEBH-5/2-1/8-P-S-B-230AC
	Sub-base valve	24 V DC	173008	MEBH-5/2-5,0-S-B
		110 V AC	173074	MEBH-5/2-5,0-S-B-110AC
		230 V AC	173116	MEBH-5/2-5,0-S-B-230AC
<b>Pneumatic spring return, internal pilot air supply</b>				
	Semi in-line valve with thread G1/8	24 V DC	173010	MEBH-5/2-1/8-L-B
		110 V AC	173044	MEBH-5/2-1/8-L-B-110AC
		230 V AC	173086	MEBH-5/2-1/8-L-B-230AC
	Semi in-line valve for manifold PRS-ME	24 V DC	173012	MEBH-5/2-1/8-P-L-B
		110 V AC	173058	MEBH-5/2-1/8-P-L-B-110AC
		230 V AC	173100	MEBH-5/2-1/8-P-L-B-230AC
	Sub-base valve	24 V DC	173011	MEBH-5/2-5,0-L-B
		110 V AC	173072	MEBH-5/2-5,0-L-B-110AC
		230 V AC	173114	MEBH-5/2-5,0-L-B-230AC
<b>Pneumatic spring return, external pilot air supply</b>				
	Semi in-line valve with thread G1/8	24 V DC	173013	MEBH-5/2-1/8-L-S-B
		110 V AC	173015	MEBH-5/2-1/8-P-L-S-B
	Semi in-line valve for manifold PRS-ME	24 V DC	173015	MEBH-5/2-1/8-P-L-S-B
		110 V AC	173059	MEBH-5/2-1/8-P-L-S-B-110AC
	Sub-base valve	24 V DC	173014	MEBH-5/2-5,0-L-S-B
110 V AC		173073	MEBH-5/2-5,0-L-S-B-110AC	

# Solenoid valves MEBH, midi pneumatics

Technical data – 5/2-way valves, double solenoid

## Dimensions

Download CAD data → [www.festo.com](http://www.festo.com)

Semi in-line valve with thread G1/8

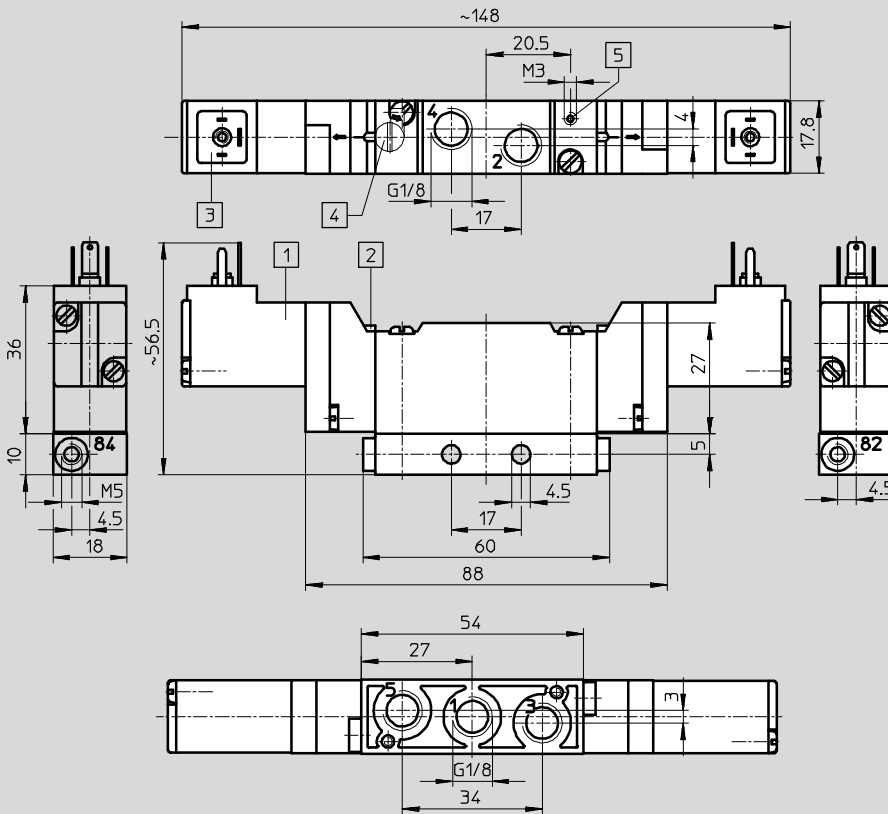

- 1 Solenoid coil can be rotated 180°<sup>1)</sup>
  - 2 Manual override
  - 3 Suitable for plug sockets to EN 175 301-803, form C: MSSD-EB or KMEB-...
  - 4 Manual override tool (accessory) AHB-ME-1/8
  - 5 Port for external pilot air on S types
- 1) The seal must not be turned!

Semi in-line valve for manifold PRS-ME

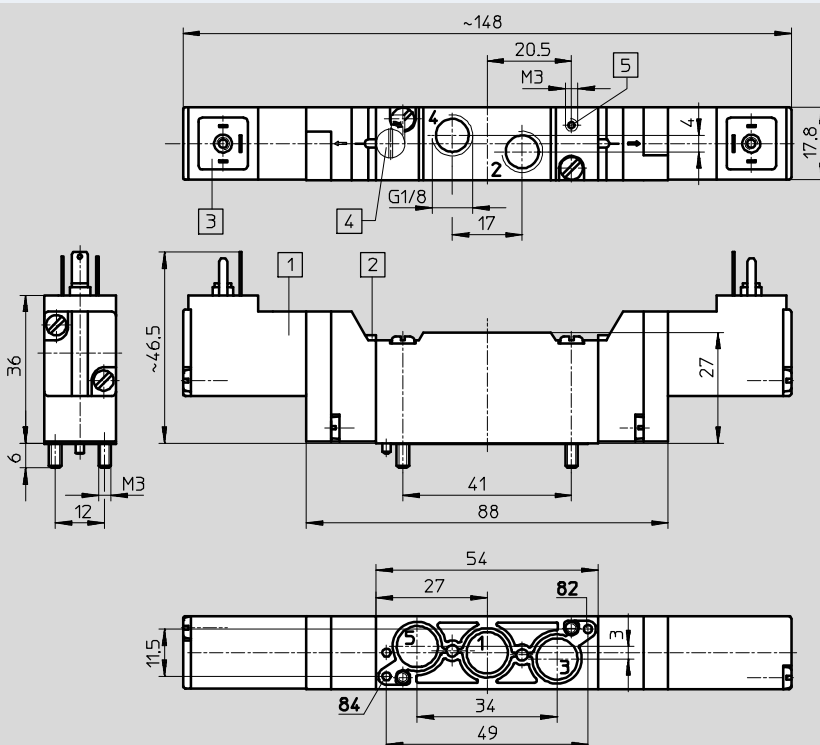

- 1 Solenoid coil can be rotated 180°<sup>1)</sup>
  - 2 Manual override
  - 3 Suitable for plug sockets to EN 175 301-803, form C: MSSD-EB or KMEB-...
  - 4 Manual override tool (accessory) AHB-ME-1/8
  - 5 Port for external pilot air on S types
- 1) The seal must not be turned!



# Solenoid valves MEBH, midi pneumatics

Technical data – 5/2-way valves, double solenoid

## Dimensions

Download CAD data → [www.festo.com](http://www.festo.com)

Sub-base valve

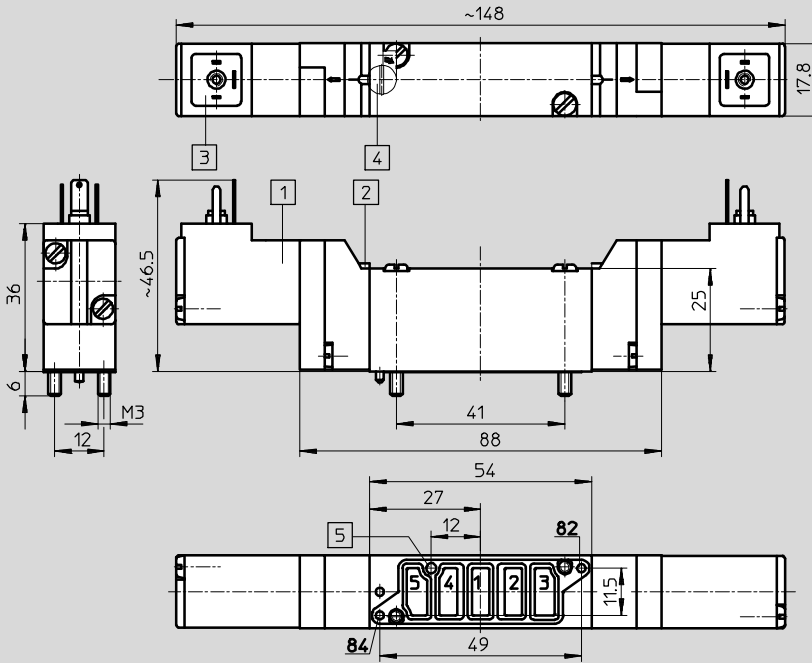

- 1 Solenoid coil can be rotated 180°<sup>1)</sup>
  - 2 Manual override
  - 3 Suitable for plug sockets to EN 175 301-803, form C: MSSD-EB or KMEB-...
  - 4 Manual override tool (accessory) AHB-ME-1/8
  - 5 Port for external pilot air on S types
- 1) The seal must not be turned!

## Ordering data

Circuit symbol	Description	Voltage	Part No.	Type
<b>Internal pilot air supply</b>				
	Semi in-line valve with thread G1/8	24 V DC	173034	JMEBH-5/2-1/8-B
		110 V AC	173040	JMEBH-5/2-1/8-B-110AC
		230 V AC	173082	JMEBH-5/2-1/8-B-230AC
	Semi in-line valve for manifold PRS-ME	24 V DC	173036	JMEBH-5/2-1/8-P-B
		110 V AC	173054	JMEBH-5/2-1/8-P-B-110AC
		230 V AC	173096	JMEBH-5/2-1/8-P-B-230AC
	Sub-base valve	24 V DC	173035	JMEBH-5/2-5,0-B
		110 V AC	173068	JMEBH-5/2-5,0-B-110AC
		230 V AC	173110	JMEBH-5/2-5,0-B-230AC
<b>External pilot air supply</b>				
	Semi in-line valve with thread G1/8	24 V DC	173037	JMEBH-5/2-1/8-S-B
		230 V AC	173083	JMEBH-5/2-1/8-S-B-230AC
	Semi in-line valve for manifold PRS-ME	110 V AC	173055	JMEBH-5/2-1/8-P-S-B-110AC
		230 V AC	173097	JMEBH-5/2-1/8-P-S-B-230AC
	Sub-base valve	24 V DC	173038	JMEBH-5/2-5,0-S-B
		230 V AC	173111	JMEBH-5/2-5,0-S-B-230AC

# Solenoid valves MEBH, midi pneumatics

Technical data – 5/3-way valves

## Dimensions

Download CAD data → [www.festo.com](http://www.festo.com)

Semi in-line valve with thread G1/8

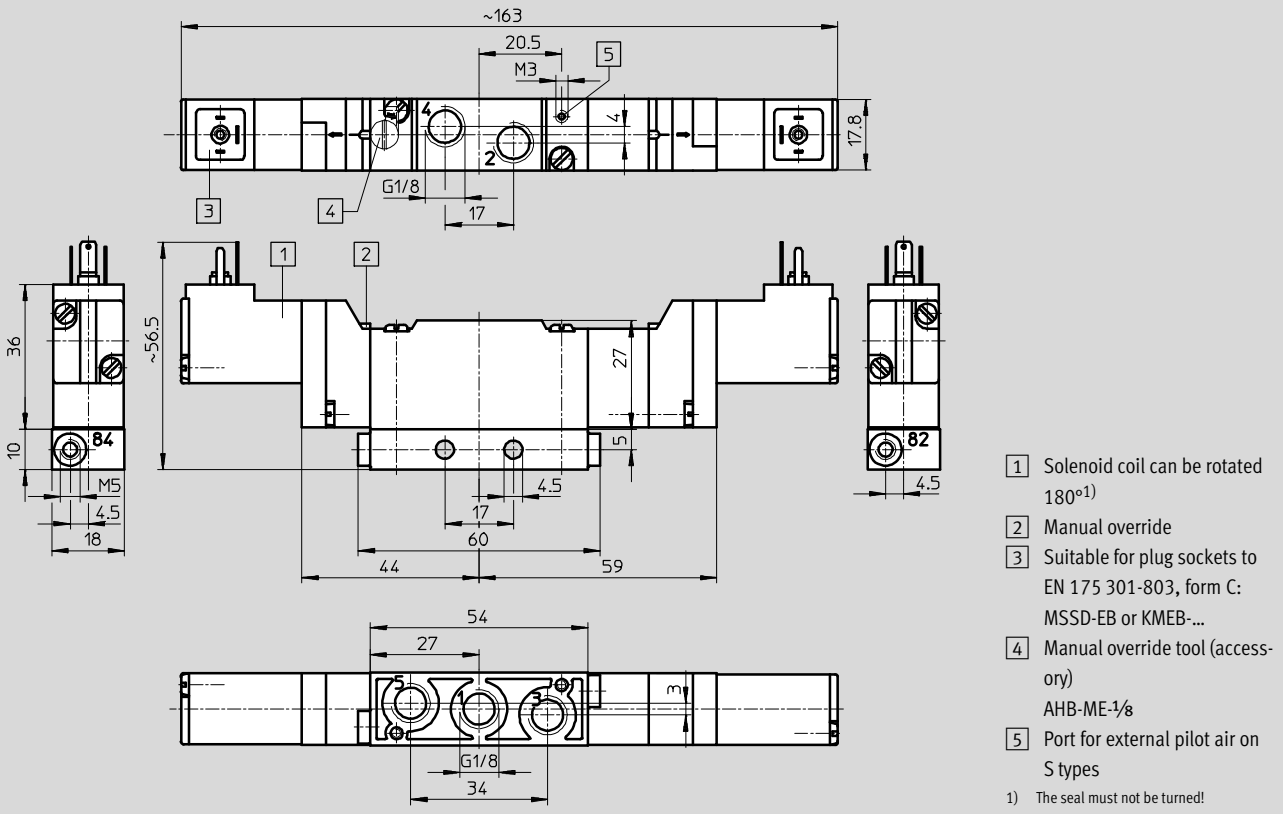

Semi in-line valve for manifold PRS-ME

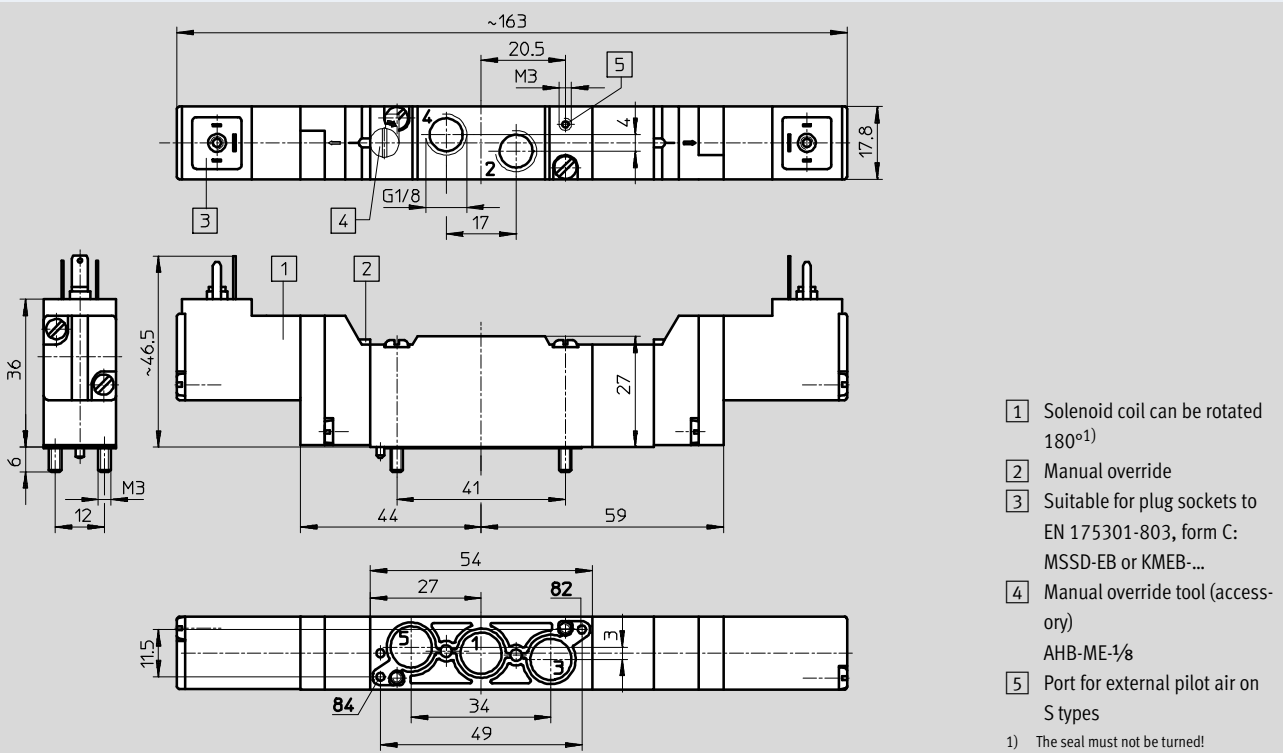

# Solenoid valves MEBH, midi pneumatics

Technical data – 5/3-way valves

## Dimensions

Download CAD data → [www.festo.com](http://www.festo.com)

Sub-base valve

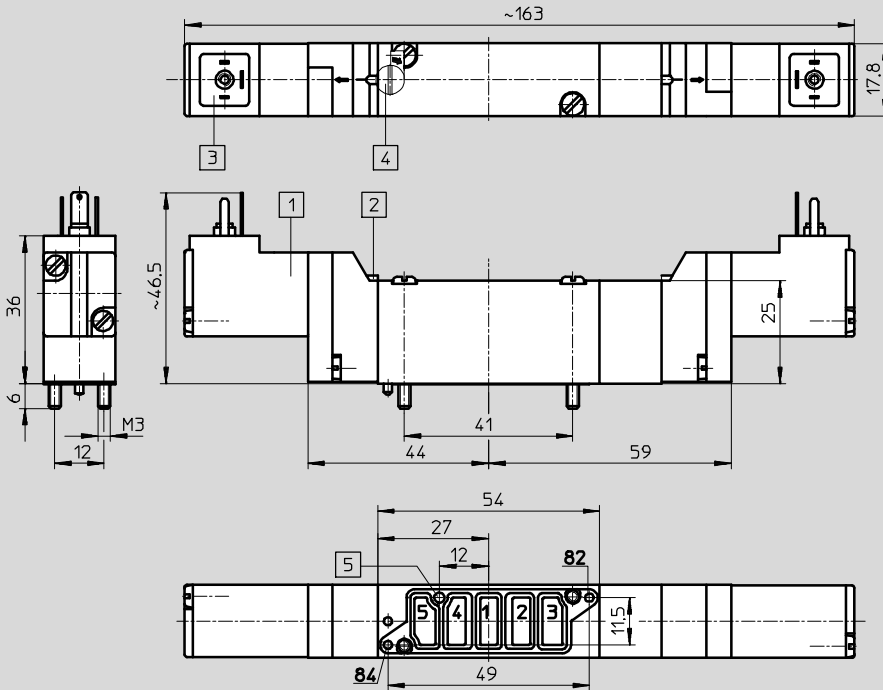

- 1 Solenoid coil can be rotated 180°<sup>1)</sup>
  - 2 Manual override
  - 3 Suitable for plug sockets to EN 175 301-803, form C: MSSD-EB or KMEB-...
  - 4 Manual override tool (accessory) AHB-ME-1/8
  - 5 Port for external pilot air on S types
- 1) The seal must not be turned!

## Ordering data

Circuit symbol	Description	Voltage	Part No.	Type
<b>Normally closed, internal pilot air supply</b>				
	Semi in-line valve with thread G1/8	24 V DC	173016	MEBH-5/3G-1/8-B
		230 V AC	173093	MEBH-5/3G-1/8-B-230AC
	Semi in-line valve for manifold PRS-ME	24 V DC	173018	MEBH-5/3G-1/8-P-B
		110 V AC	173065	MEBH-5/3G-1/8-P-B-110AC
		230 V AC	173107	MEBH-5/3G-1/8-P-B-230AC
	Sub-base valve	24 V DC	173017	MEBH-5/3G-5,0-B
	110 V AC	173079	MEBH-5/3G-5,0-B-110AC	
	230 V AC	173121	MEBH-5/3G-5,0-B-230AC	
<b>Normally closed, external pilot air supply</b>				
	Semi in-line valve with thread G1/8	24 V DC	173019	MEBH-5/3G-1/8-S-B
	Semi in-line valve for manifold PRS-ME	24 V DC	173021	MEBH-5/3G-1/8-P-S-B
	Sub-base valve	24 V DC	173020	MEBH-5/3G-5,0-S-B
		230 V AC	173122	MEBH-5/3G-5,0-S-B-230AC

# Solenoid valves MEBH, midi pneumatics

Technical data – 5/3-way valves

Ordering data				
Circuit symbol	Description	Voltage	Part No.	Type
<b>Normally exhausted, internal pilot air supply</b>				
	Semi in-line valve with thread G1/8	24 V DC	<b>173022</b>	<b>MEBH-5/3E-1/8-B</b>
		230 V AC	<b>173091</b>	<b>MEBH-5/3E-1/8-B-230AC</b>
	Semi in-line valve for manifold PRS-ME	24 V DC	<b>173024</b>	<b>MEBH-5/3E-1/8-P-B</b>
		110 V AC	<b>173063</b>	<b>MEBH-5/3E-1/8-P-B-110AC</b>
	Sub-base valve	24 V DC	<b>173023</b>	<b>MEBH-5/3E-5,0-B</b>
		110 V AC	<b>173077</b>	<b>MEBH-5/3E-5,0-B-110AC</b>
		230 V AC	<b>173119</b>	<b>MEBH-5/3E-5,0-B-230AC</b>
<b>Normally exhausted, external pilot air supply</b>				
	Semi in-line valve for manifold PRS-ME	24 V DC	<b>173027</b>	<b>MEBH-5/3E-1/8-P-S-B</b>
	Sub-base valve	24 V DC	<b>173026</b>	<b>MEBH-5/3E-5,0-S-B</b>
		230 V AC	<b>173120</b>	<b>MEBH-5/3E-5,0-S-B-230AC</b>
<b>Normally pressurised, internal pilot air supply</b>				
	Semi in-line valve with thread G1/8	24 V DC	<b>173028</b>	<b>MEBH-5/3B-1/8-B</b>
		230 V AC	<b>173089</b>	<b>MEBH-5/3B-1/8-B-230AC</b>
	Semi in-line valve for manifold PRS-ME	24 V DC	<b>173030</b>	<b>MEBH-5/3B-1/8-P-B</b>
		230 V AC	<b>173103</b>	<b>MEBH-5/3B-1/8-P-B-230AC</b>
	Sub-base valve	24 V DC	<b>173029</b>	<b>MEBH-5/3B-5,0-B</b>
<b>Normally pressurised, external pilot air supply</b>				
	Semi in-line valve with thread G1/8	24 V DC	<b>173031</b>	<b>MEBH-5/3B-1/8-S-B</b>
	Sub-base valve	24 V DC	<b>173032</b>	<b>MEBH-5/3B-5,0-S-B</b>

# Solenoid valves MEH, midi pneumatics

Technical data

-  - Flow rate  
200 ... 700 l/min

-  - Voltage  
24 V DC

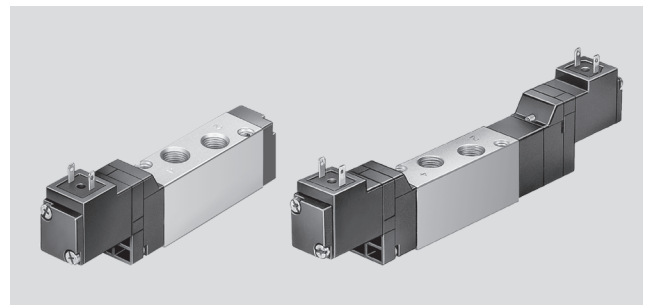

General technical data							
Type		MEH-3/2-... MOEH-3/2-...	MEH-5/2-...	JMEH-5/2-...	MEH-5/3...		
Design		Piston spool					
Type of mounting	...-1/8	2 through-holes					
	...-5.0	On sub-base with two M3 screws					
	...-1/8-P	On manifold with two M3 screws					
Pneumatic connection	...-1/8	G1/8					
	...-5.0	Sub-base					
	...-1/8-P	G1/8					
Lap		Overlap					
Nominal size	[mm]	5					
Standard nominal flow rate 1 > 2, 1 > 4	...-1/8	600/500	600	650	G	E	B
	...-5.0	700/600	700	700	600	300	200
	...-1/8-P	600/500	600	650	500	400	400
Materials		Housing: Aluminium Seals: Nitrile rubber					
Weight	[g]	...-1/8	105	105	142	153	
		...-5.0	105	105	146	150	
		...-1/8-P	105	105	142	153	

Operating and environmental conditions							
Type		MEH-3/2-... MOEH-3/2-...	MEH-5/2-...	JMEH-5/2-...	MEH-5/3...		
Operating medium		Compressed air in accordance with ISO 8573-1:2010 [7:4:4] <sup>1)</sup>					
Note on operating/pilot medium		Operation with lubricated medium possible (in which case lubricated operation will always be required)					
Operating pressure range	Internal pilot air supply	[bar]	2 ... 8	2.5 ... 8	1.5 ... 8	3 ... 8	
	External pilot air supply	[bar]	-	-0.9 ... +10			
Pilot pressure range		[bar]	-	2.5 ... 8	1.5 ... 8	3 ... 8	
Ambient temperature		[°C]	-5 ... +50				
Temperature of medium		[°C]	-5 ... +50				
Note on materials			RoHS-compliant				

1) Only oils of viscosity class 32 may be used for lubricated operation.

## Solenoid valves MEH, midi pneumatics

FESTO

Technical data

Valve response times [ms]							
Type	MEH-3/2-... MOEH-3/2-...		MEH-5/2-...		JMEH-5/2-...	MEH-5/3...	
Type of reset	mechanical	pneumatic	mechanical	pneumatic	–	mechanical	pneumatic
On	10	–	10	15	–	12	–
Off	28	–	28	18	–	25	–
Changeover	–	–	–	–	10	–	–

Electrical data	
E solenoid coil	
Electrical connection	Plug, square, connection pattern type C, to industry standard 9.4 mm
Operating voltage	[V DC] 24
Coil characteristics	[W] 1.5
Protection class to EN 60 529	IP65 (in combination with plug socket)

# Solenoid valves MEH, midi pneumatics

Technical data – 3/2-way valves

## Dimensions

Download CAD data → [www.festo.com](http://www.festo.com)

Semi in-line valve with thread G1/8

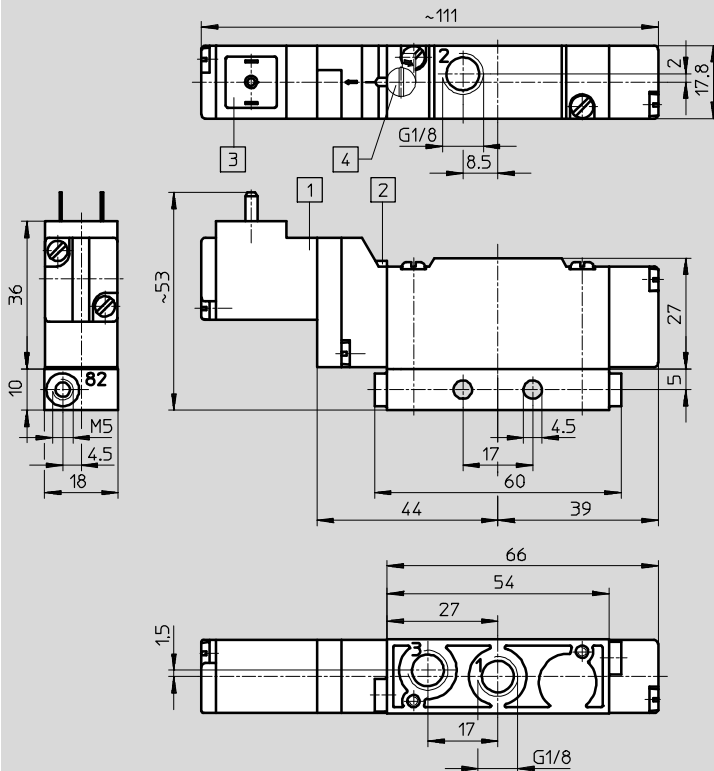

- 1) Solenoid coil can be rotated 180°<sup>1)</sup>
  - 2) Manual override
  - 3) Suitable for terminal sockets to DIN 46 247 or plug sockets MSSD-E type KME type
  - 4) Manual override tool (accessory) AHB-ME-1/8
- 1) The seal must not be turned!

Semi in-line valve for manifold PRS-ME

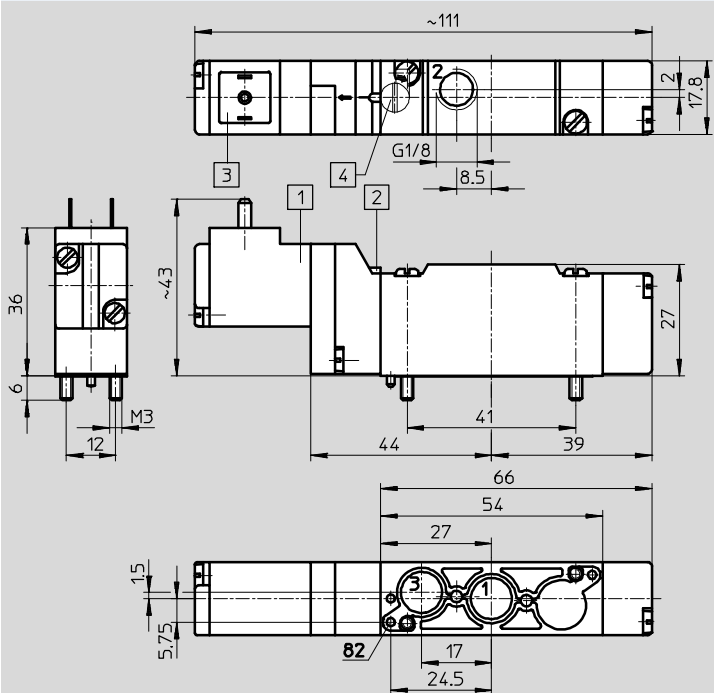

- 1) Solenoid coil can be rotated 180°<sup>1)</sup>
  - 2) Manual override
  - 3) Suitable for terminal sockets to DIN 46 247 or plug sockets MSSD-E type KME type
  - 4) Manual override tool (accessory) AHB-ME-1/8
- 1) The seal must not be turned!

# Solenoid valves MEH, midi pneumatics

Technical data – 3/2-way valves

Dimensions Download CAD data → [www.festo.com](http://www.festo.com)  
 Sub-base valve

1) Solenoid coil can be rotated 180°<sup>1)</sup>  
 2) Manual override  
 3) Suitable for terminal sockets to DIN 46 247 or plug sockets MSSD-E type KME type  
 4) Manual override tool (accessory) AHB-ME-1/8  
 1) The seal must not be turned!

Ordering data				
Circuit symbol	Description	Voltage	Part No.	Type
<b>Normally closed</b>				
	Semi in-line valve with thread G1/8	24 V DC	173124	MEH-3/2-1/8-B
	Semi in-line valve for manifold PRS-ME		173126	MEH-3/2-1/8-P-B
	Sub-base valve		173125	MEH-3/2-5,0-B
<b>Normally open</b>				
	Semi in-line valve with thread G1/8	24 V DC	173428	MOEH-3/2-1/8-B
	Semi in-line valve for manifold PRS-ME		173430	MOEH-3/2-1/8-P-B
	Sub-base valve		173429	MOEH-3/2-5,0-B



# Solenoid valves MEH, midi pneumatics

Technical data – 5/2-way valves

## Dimensions

Download CAD data → [www.festo.com](http://www.festo.com)

Semi in-line valve with thread G1/8

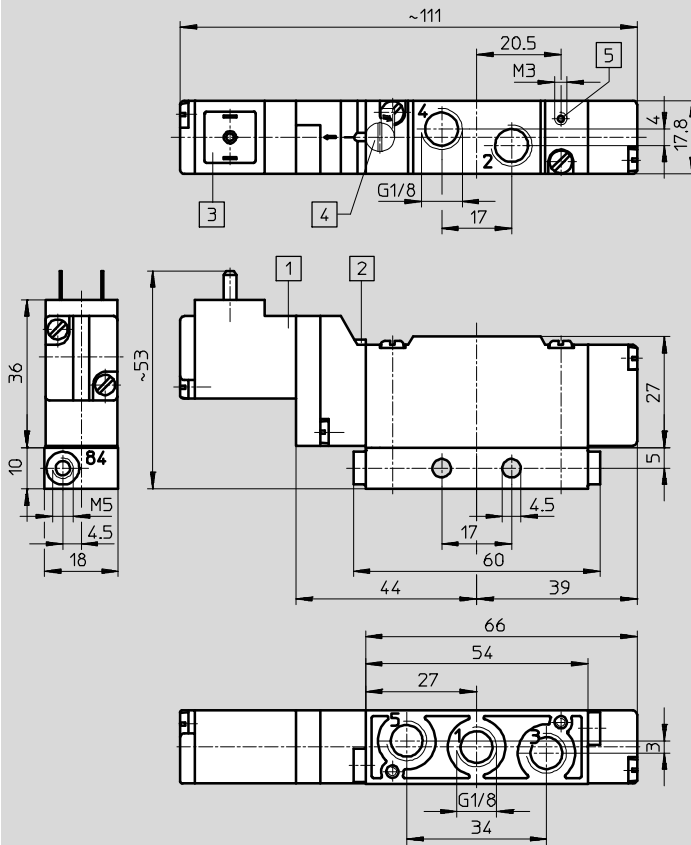

- 1) Solenoid coil can be rotated 180°<sup>1)</sup>
  - 2) Manual override
  - 3) Suitable for terminal sockets to DIN 46247 or plug sockets MSSD-E type KME type
  - 4) Manual override tool (accessory) AHB-ME-1/8
  - 5) Port for external pilot air on S types
- 1) The seal must not be turned!

Semi in-line valve for manifold PRS-ME

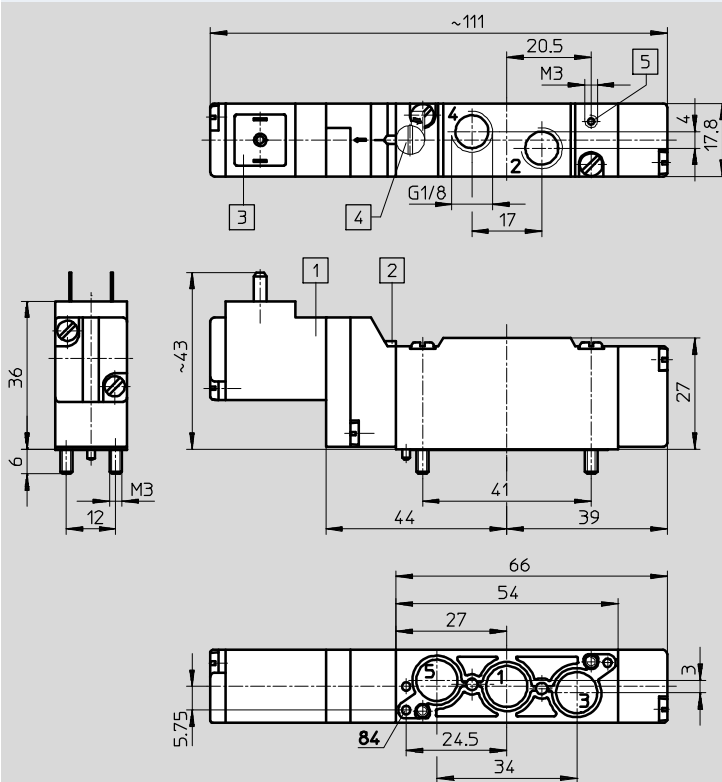

- 1) Solenoid coil can be rotated 180°<sup>1)</sup>
  - 2) Manual override
  - 3) Suitable for terminal sockets to DIN 46247 or plug sockets MSSD-E type KME type
  - 4) Manual override tool (accessory) AHB-ME-1/8
  - 5) Port for external pilot air on S types
- 1) The seal must not be turned!

# Solenoid valves MEH, midi pneumatics

Technical data – 5/2-way valves

## Dimensions

Download CAD data → [www.festo.com](http://www.festo.com)

Sub-base valve

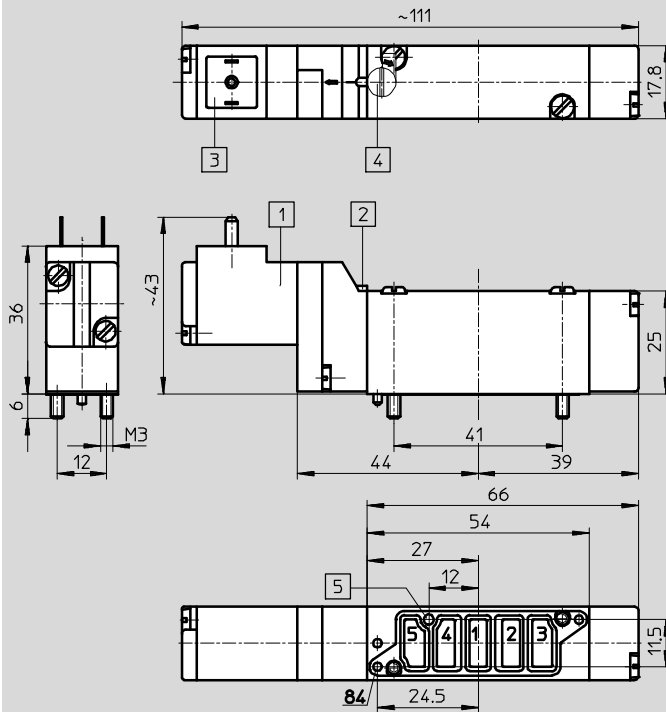

- 1) Solenoid coil can be rotated 180°<sup>1)</sup>
- 2) Manual override
- 3) Suitable for terminal sockets to DIN 46247 or plug sockets MSSD-E type KME type
- 4) Manual override tool (accessory) AHB-ME-1/8
- 5) Port for external pilot air on S types

1) The seal must not be turned!

# Solenoid valves MEH, midi pneumatics

Technical data – 5/2-way valves

Ordering data				
Circuit symbol	Description	Voltage	Part No.	Type
<b>Mechanical spring return, internal pilot air supply</b>				
	Semi in-line valve with thread G1/8	24 V DC	173127	MEH-5/2-1/8-B
	Semi in-line valve for manifold PRS-ME		173129	MEH-5/2-1/8-P-B
	Sub-base valve		173128	MEH-5/2-5,0-B
<b>Mechanical spring return, external pilot air supply</b>				
	Semi in-line valve with thread G1/8	24 V DC	173130	MEH-5/2-1/8-S-B
	Semi in-line valve for manifold PRS-ME		173132	MEH-5/2-1/8-P-S-B
	Sub-base valve		173131	MEH-5/2-5,0-S-B
<b>Pneumatic spring return, internal pilot air supply</b>				
	Semi in-line valve with thread G1/8	24 V DC	173133	MEH-5/2-1/8-L-B
	Semi in-line valve for manifold PRS-ME		173135	MEH-5/2-1/8-P-L-B
	Sub-base valve		173134	MEH-5/2-5,0-L-B
<b>Pneumatic spring return, external pilot air supply</b>				
	Semi in-line valve with thread G1/8	24 V DC	173136	MEH-5/2-1/8-L-S-B
	Semi in-line valve for manifold PRS-ME		173138	MEH-5/2-1/8-P-L-S-B
	Sub-base valve		173137	MEH-5/2-5,0-L-S-B

# Solenoid valves MEH, midi pneumatics

Technical data – 5/2-way valves, double solenoid

## Dimensions

Download CAD data → [www.festo.com](http://www.festo.com)

Semi in-line valve with thread G1/8

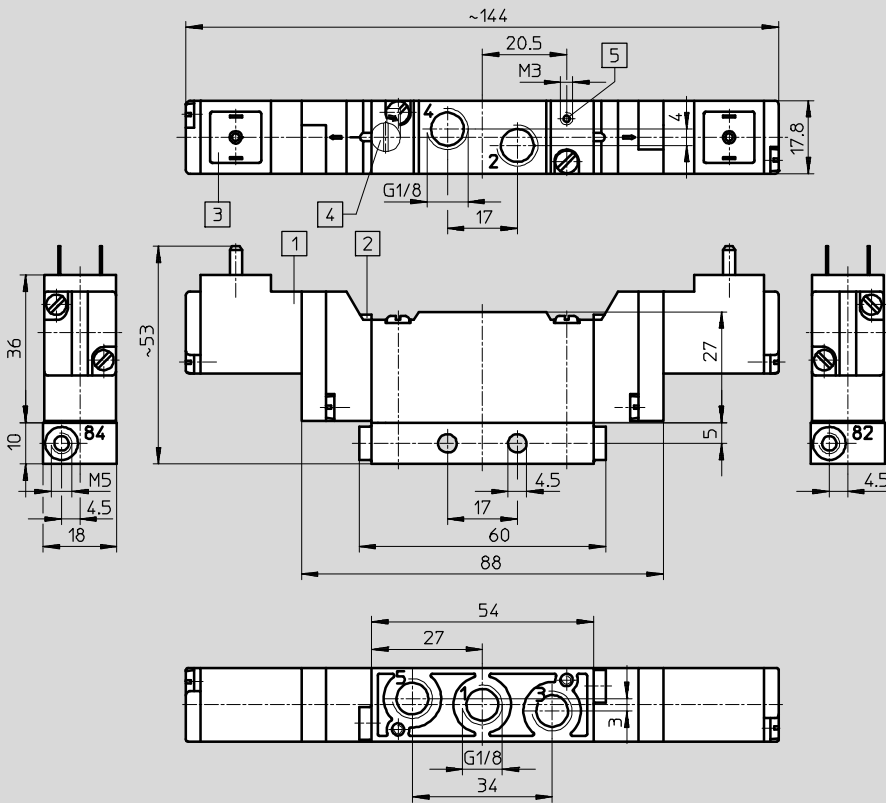

- 1) Solenoid coil can be rotated 180°<sup>1)</sup>
  - 2) Manual override
  - 3) Suitable for terminal sockets to DIN 46 247 or plug sockets MSSD-E type KME type
  - 4) Manual override tool (accessory) AHB-ME-1/8
  - 5) Port for external pilot air on S types
- 1) The seal must not be turned!

Semi in-line valve for manifold PRS-ME

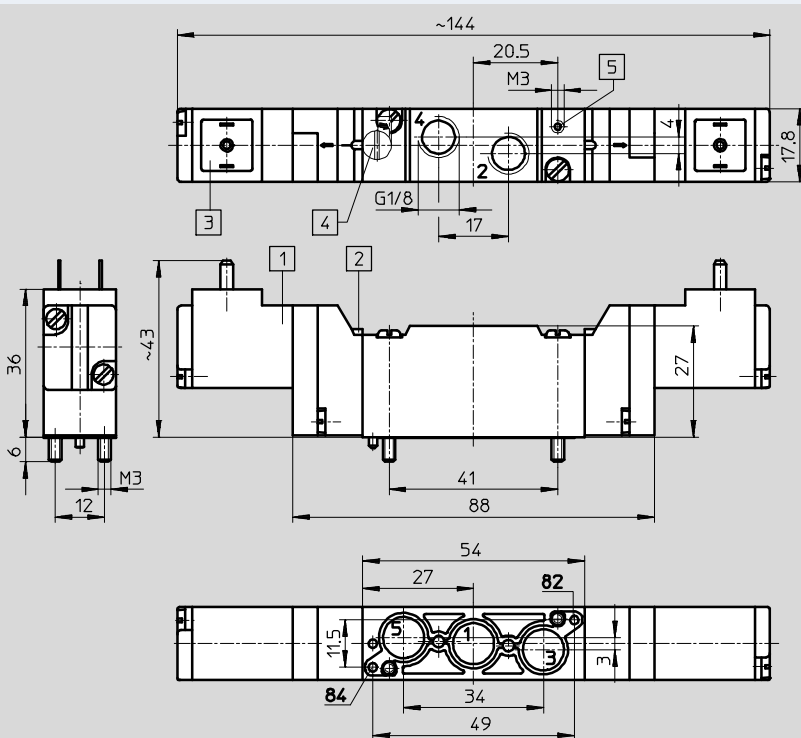

- 1) Solenoid coil can be rotated 180°<sup>1)</sup>
  - 2) Manual override
  - 3) Suitable for terminal sockets to DIN 46 247 or plug sockets MSSD-E type KME type
  - 4) Manual override tool (accessory) AHB-ME-1/8
  - 5) Port for external pilot air on S types
- 1) The seal must not be turned!

# Solenoid valves MEH, midi pneumatics

Technical data – 5/2-way valves, double solenoid

## Dimensions

Download CAD data → [www.festo.com](http://www.festo.com)

Sub-base valve

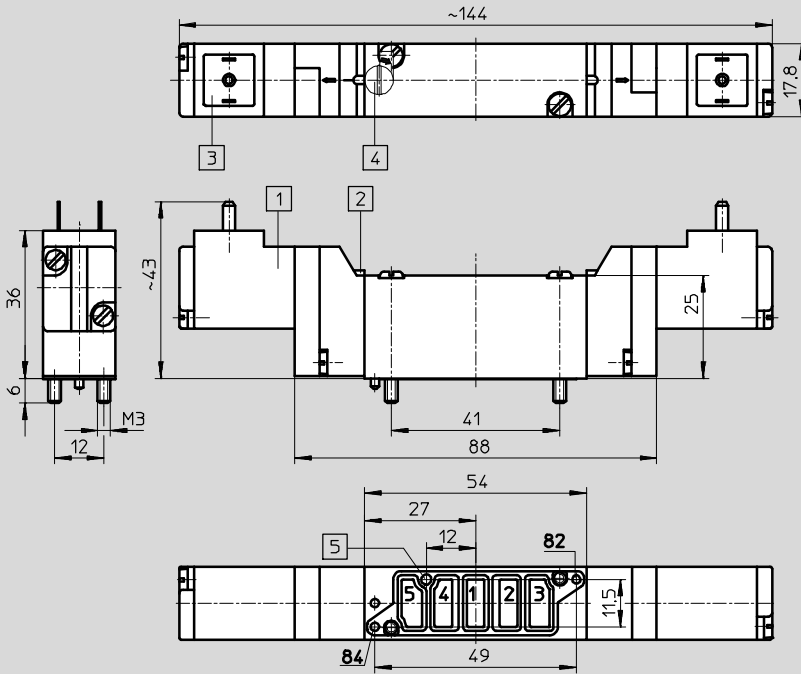

- 1 Solenoid coil can be rotated 180°<sup>1)</sup>
  - 2 Manual override
  - 3 Suitable for terminal sockets to DIN 46 247 or plug sockets MSSD-E type KME type
  - 4 Manual override tool (accessory) AHB-ME-1/8
  - 5 Port for external pilot air on S types
- 1) The seal must not be turned!

## Ordering data

Circuit symbol	Description	Voltage	Part No.	Type
<b>5/2-way valves</b>				
<b>Internal pilot air supply</b>				
	Semi in-line valve with thread G1/8	24 V DC	173431	JMEH-5/2-1/8-B
	Semi in-line valve for manifold PRS-ME		173433	JMEH-5/2-1/8-P-B
	Sub-base valve		173432	JMEH-5/2-5,0-B
<b>External pilot air supply</b>				
	Semi in-line valve with thread G1/8	24 V DC	173434	JMEH-5/2-1/8-S-B
	Semi in-line valve for manifold PRS-ME		173436	JMEH-5/2-1/8-P-S-B
	Sub-base valve		173435	JMEH-5/2-5,0-S-B

# Solenoid valves MEH, midi pneumatics

Technical data – 5/3-way valves

## Dimensions

Download CAD data → [www.festo.com](http://www.festo.com)

Semi in-line valve with thread G1/8

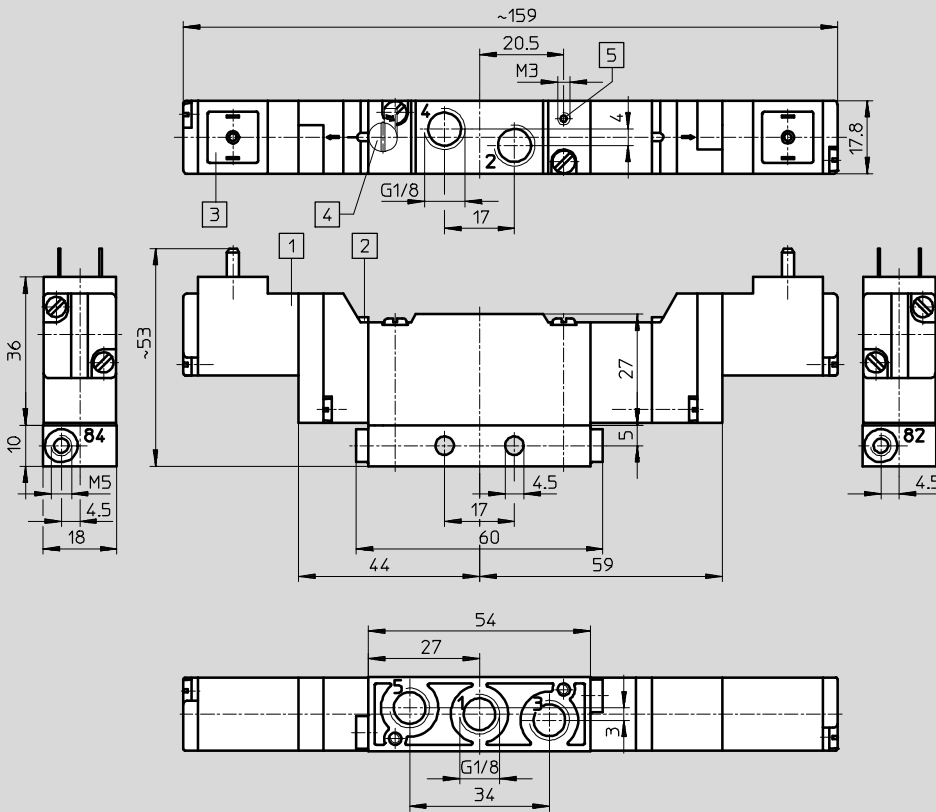

- 1 Solenoid coil can be rotated 180°<sup>1)</sup>
  - 2 Manual override
  - 3 Suitable for terminal sockets to DIN 46 247 or plug sockets MSSD-E type KME type
  - 4 Manual override tool (accessory) AHB-ME-1/8
  - 5 Port for external pilot air on S types
- 1) The seal must not be turned!

Semi in-line valve for manifold PRS-ME

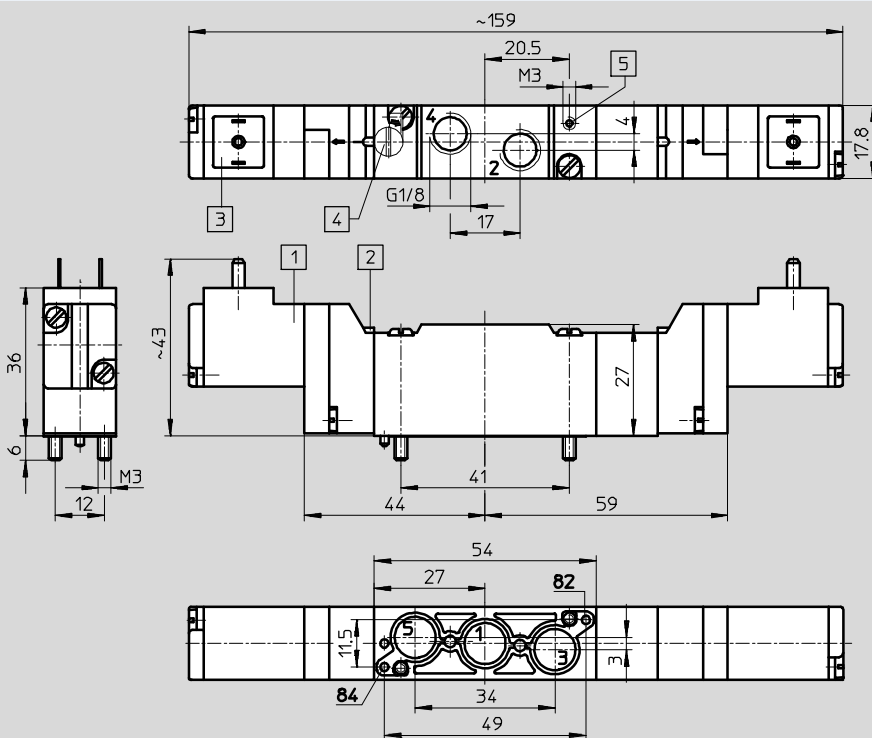

- 1 Solenoid coil can be rotated 180°<sup>1)</sup>
  - 2 Manual override
  - 3 Suitable for terminal sockets to DIN 46 247 or plug sockets MSSD-E type KME type
  - 4 Manual override tool (accessory) AHB-ME-1/8
  - 5 Port for external pilot air on S types
- 1) The seal must not be turned!

# Solenoid valves MEH, midi pneumatics

Technical data – 5/3-way valves

## Dimensions

Download CAD data → [www.festo.com](http://www.festo.com)

Sub-base valve

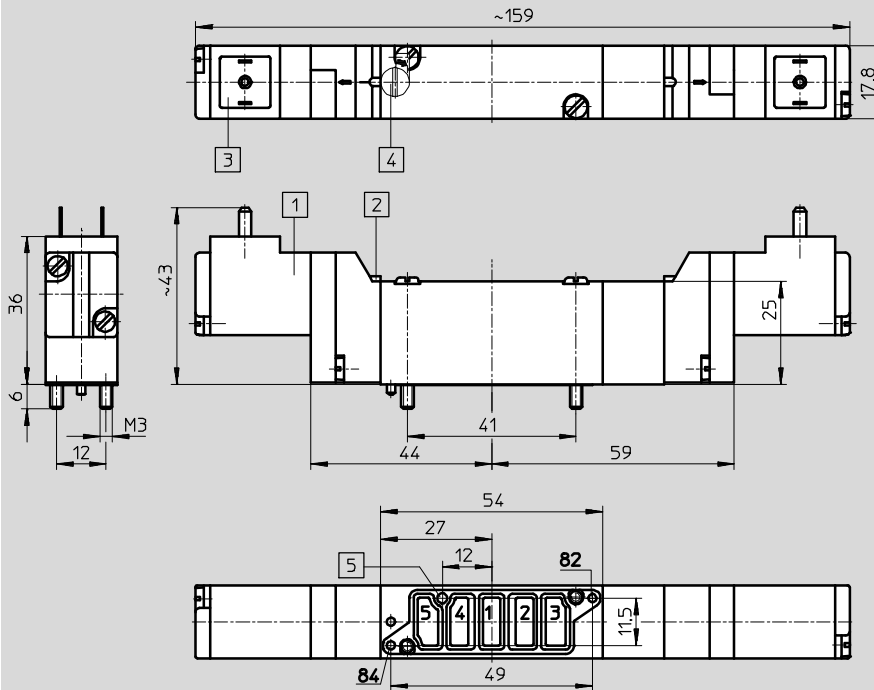

- 1) Solenoid coil can be rotated 180°<sup>1)</sup>
  - 2) Manual override
  - 3) Suitable for terminal sockets to DIN 46 247 or plug sockets MSSD-E type KME type
  - 4) Manual override tool (accessory) AHB-ME-1/8
  - 5) Port for external pilot air on S types
- 1) The seal must not be turned!

# Solenoid valves MEH, midi pneumatics

Technical data – 5/3-way valves

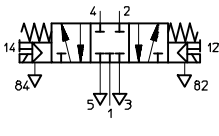
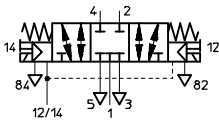
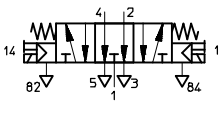
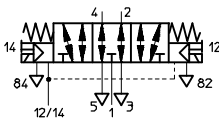
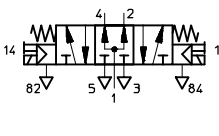
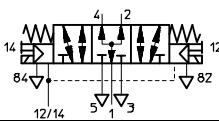
Ordering data				
Circuit symbol	Description	Voltage	Part No.	Type
<b>Normally closed, internal pilot air supply</b>				
	Semi in-line valve with thread G $\frac{1}{8}$	24 V DC	173139	MEH-5/3G- $\frac{1}{8}$ -B
	Semi in-line valve for manifold PRS-ME		173141	MEH-5/3G- $\frac{1}{8}$ -P-B
	Sub-base valve		173140	MEH-5/3G-5,0-B
<b>Normally closed, external pilot air supply</b>				
	Semi in-line valve with thread G $\frac{1}{8}$	24 V DC	173142	MEH-5/3G- $\frac{1}{8}$ -S-B
	Semi in-line valve for manifold PRS-ME		173144	MEH-5/3G- $\frac{1}{8}$ -P-S-B
	Sub-base valve		173143	MEH-5/3G-5,0-S-B
<b>Normally exhausted, internal pilot air supply</b>				
	Semi in-line valve with thread G $\frac{1}{8}$	24 V DC	173145	MEH-5/3E- $\frac{1}{8}$ -B
	Semi in-line valve for manifold PRS-ME		173147	MEH-5/3E- $\frac{1}{8}$ -P-B
	Sub-base valve		173146	MEH-5/3E-5,0-B
<b>Normally exhausted, external pilot air supply</b>				
	Semi in-line valve with thread G $\frac{1}{8}$	24 V DC	173148	MEH-5/3E- $\frac{1}{8}$ -S-B
	Semi in-line valve for manifold PRS-ME		173150	MEH-5/3E- $\frac{1}{8}$ -P-S-B
	Sub-base valve		173149	MEH-5/3E-5,0-S-B
<b>Normally pressurised, internal pilot air supply</b>				
	Semi in-line valve with thread G $\frac{1}{8}$	24 V DC	173151	MEH-5/3B- $\frac{1}{8}$ -B
	Semi in-line valve for manifold PRS-ME		173153	MEH-5/3B- $\frac{1}{8}$ -P-B
	Sub-base valve		173152	MEH-5/3B-5,0-B
<b>Normally pressurised, external pilot air supply</b>				
	Semi in-line valve with thread G $\frac{1}{8}$	24 V DC	173154	MEH-5/3B- $\frac{1}{8}$ -S-B
	Semi in-line valve for manifold PRS-ME		173156	MEH-5/3B- $\frac{1}{8}$ -P-S-B



# Pneumatic valves VL/J, midi pneumatics

Type codes

VL – 5/3 B – 1/8 – P – B

**Type**

VL	Single solenoid
J	Double solenoid

**Valve function**

5/2	5/2-way valve
5/3	5/3-way valve

**Normal position**

G	Closed
E	Exhausted
B	Pressurised

**Design, pneumatic connection/nominal size**

1/8	Semi in-line valve, thread G1/8
5.0	Sub-base valve, 5 mm

**Mounting method**

P	On manifold PRS-ME
---	--------------------

**Generation**

B	B series
---	----------

# Pneumatic valves VL/J, midi pneumatics

FESTO

Technical data

Flow rate  
300 ... 700 l/min

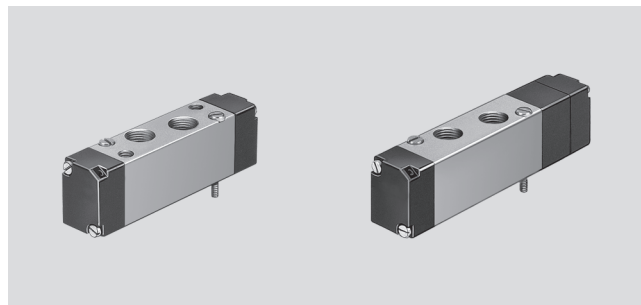

General technical data											
Type		VL-5/2-...	J-5/2-...	VL-5/3...							
Design		Piston spool, directly actuated									
Type of mounting	...-1/8	2 through-holes									
	...-5.0	On sub-base with two M3 screws									
	...-1/8-P	On manifold with two M3 screws									
Pneumatic connection	Working lines	...-1/8	G1/8								
		...-5.0	On sub-base								
	Pilot line	...-1/8-P	G1/8								
Lap		Overlap									
Nominal size	[mm]	5									
Standard nominal flow rate	[l/min]	1 → 2, 1 → 4	...-1/8	600	650	G	E	B			
						...-5.0	700	700	500	350	300
						...-1/8-P	600	650	600	350	300
						500	350	300			
Pilot air supply		External									
Direction of flow		Reversible									
Materials		Housing: Aluminium Seals: Nitrile rubber									
Weight	[g]	...-1/8	75	75	95						
		...-5.0	65	65	85						
		...-1/8-P	60	60	80						

Operating and environmental conditions						
Type		VL-5/2-...	J-5/2-...	VL-5/3...		
Operating medium		Compressed air in accordance with ISO 8573-1:2010 [7:4:4] <sup>1)</sup>				
Note on operating/pilot medium		Operation with lubricated medium possible (in which case lubricated operation will always be required)				
Operating pressure range	[bar]	-0.9 ... +10				
Pilot pressure range	[bar]	2.5 ... 8	1.5 ... 8	3 ... 8		
Ambient temperature	[°C]	-5 ... +50				
Temperature of medium	[°C]	-5 ... +50				
Note on materials		RoHS-compliant				

1) Only oils of viscosity class 32 may be used for lubricated operation.

Valve response times [ms]			
Type	VL-5/2-...	J-5/2-...	VL-5/3-...
On	6	-	6
Off	24	-	22
Changeover	-	5	-

# Pneumatic valves VL/J, midi pneumatics

Technical data – 5/2-way valves

## Dimensions

Download CAD data → [www.festo.com](http://www.festo.com)

### Semi in-line valve with thread G1/8

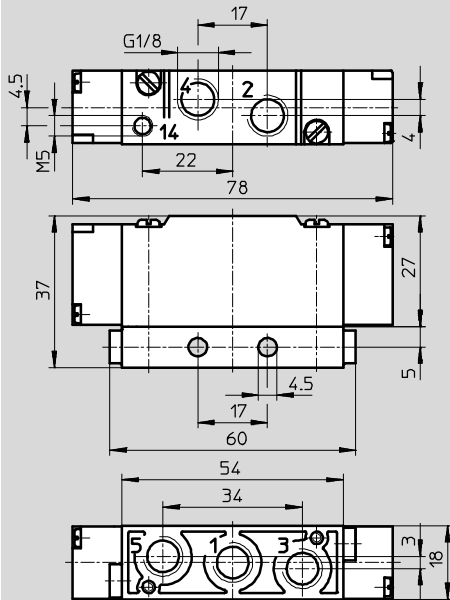

### Semi in-line valve for manifold PRS-ME

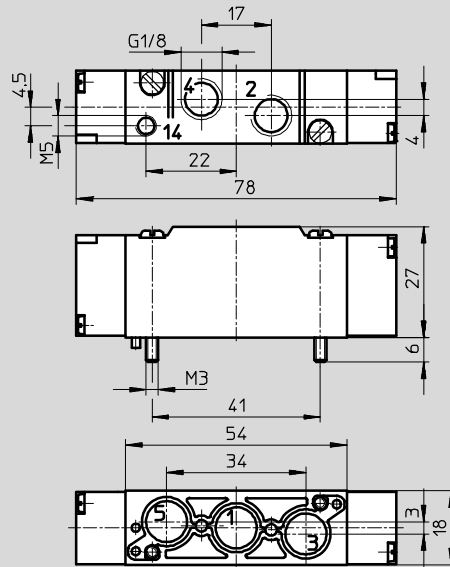

### Sub-base valve

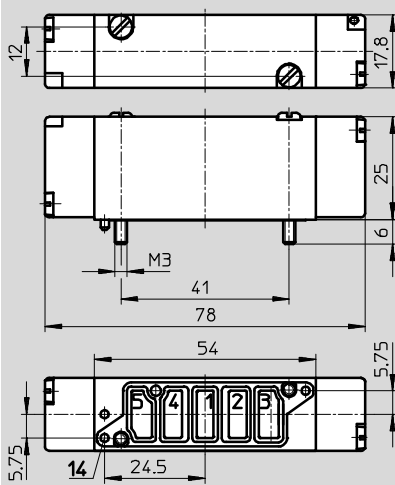

## Ordering data

Circuit symbol	Description	Part No.	Type
	Semi in-line valve with thread G1/8	173168	VL-5/2-1/8-B
	Sub-base valve	173169	VL-5/2-5,0-B
	Semi in-line valve for manifold PRS-ME	173170	VL-5/2-1/8-P-B

# Pneumatic valves VL/J, midi pneumatics

Technical data – 5/2-way valves, double pilot

## Dimensions

Download CAD data → [www.festo.com](http://www.festo.com)

Semi in-line valve with thread G $\frac{1}{8}$

Semi in-line valve for manifold PRS-ME

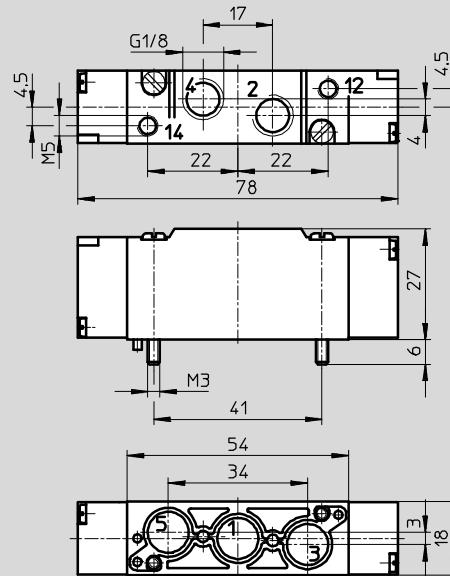
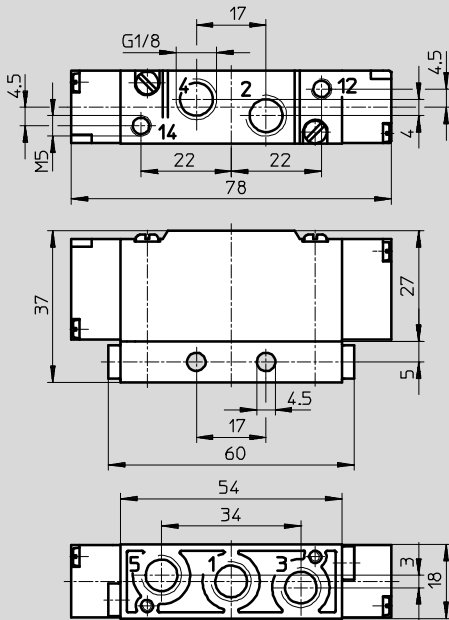

Sub-base valve

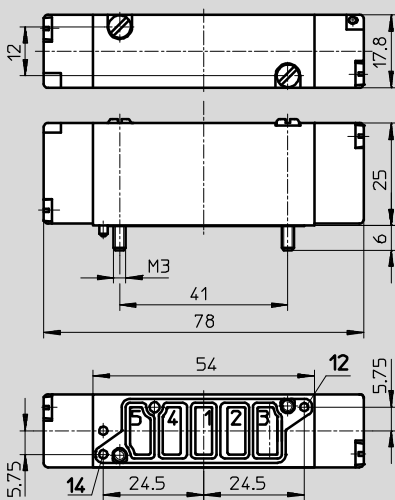

## Ordering data

Circuit symbol	Description	Part No.	Type
	Semi in-line valve with thread G $\frac{1}{8}$	173171	J-5/2- $\frac{1}{8}$ -B
	Sub-base valve	173172	J-5/2-5,0-B
	Semi in-line valve for manifold PRS-ME	173173	J-5/2- $\frac{1}{8}$ -P-B

# Pneumatic valves VL/J, midi pneumatics

Technical data – 5/3-way valves

## Dimensions

Download CAD data → [www.festo.com](http://www.festo.com)

Semi in-line valve with thread G1/8

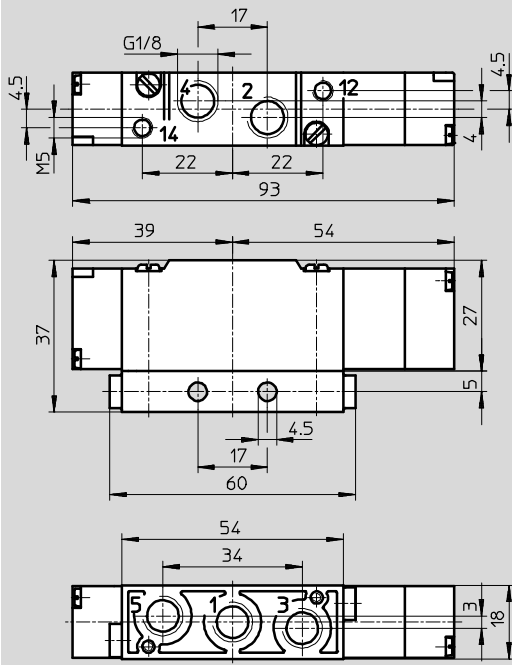

Semi in-line valve for manifold PRS-ME

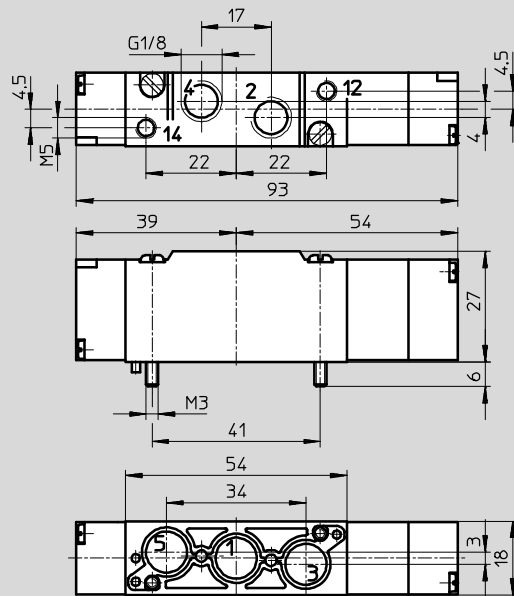

Sub-base valve

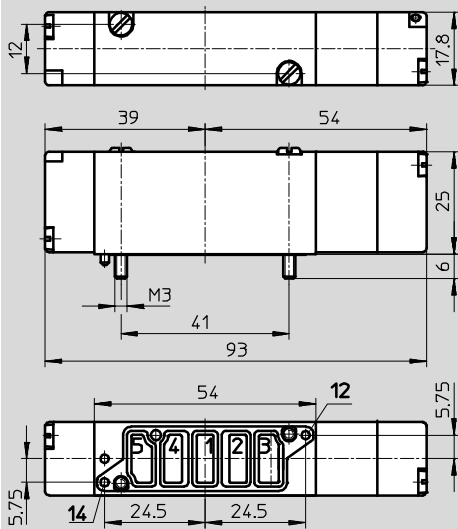

# Pneumatic valves VL/J, midi pneumatics

Technical data – 5/3-way valves

Ordering data			
Circuit symbol	Description	Part No.	Type
<b>Normally closed</b>			
	Semi in-line valve with thread G $\frac{1}{8}$	<b>173174</b>	<b>VL-5/3G-<math>\frac{1}{8}</math>-B</b>
	Sub-base valve	<b>173175</b>	<b>VL-5/3G-5,0-B</b>
	Semi in-line valve for manifold PRS-ME	<b>173176</b>	<b>VL-5/3G-<math>\frac{1}{8}</math>-P-B</b>
<b>Normally exhausted</b>			
	Semi in-line valve with thread G $\frac{1}{8}$	<b>173177</b>	<b>VL-5/3E-<math>\frac{1}{8}</math>-B</b>
	Sub-base valve	<b>173178</b>	<b>VL-5/3E-5,0-B</b>
	Semi in-line valve for manifold PRS-ME	<b>173179</b>	<b>VL-5/3E-<math>\frac{1}{8}</math>-P-B</b>
<b>Normally pressurised</b>			
	Semi in-line valve with thread G $\frac{1}{8}$	<b>173180</b>	<b>VL-5/3B-<math>\frac{1}{8}</math>-B</b>
	Sub-base valve	<b>173181</b>	<b>VL-5/3B-5,0-B</b>
	Semi in-line valve for manifold PRS-ME	<b>173182</b>	<b>VL-5/3B-<math>\frac{1}{8}</math>-P-B</b>

# Solenoid/pneumatic valves, midi pneumatics

Accessories

Individual sub-bases  
AS, AU

Material:  
Die-cast aluminium

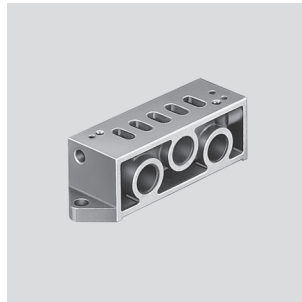

## Dimensions – Individual sub-bases

Download CAD data → [www.festo.com](http://www.festo.com)

AS-ME-1/8

AS-VL-1/8

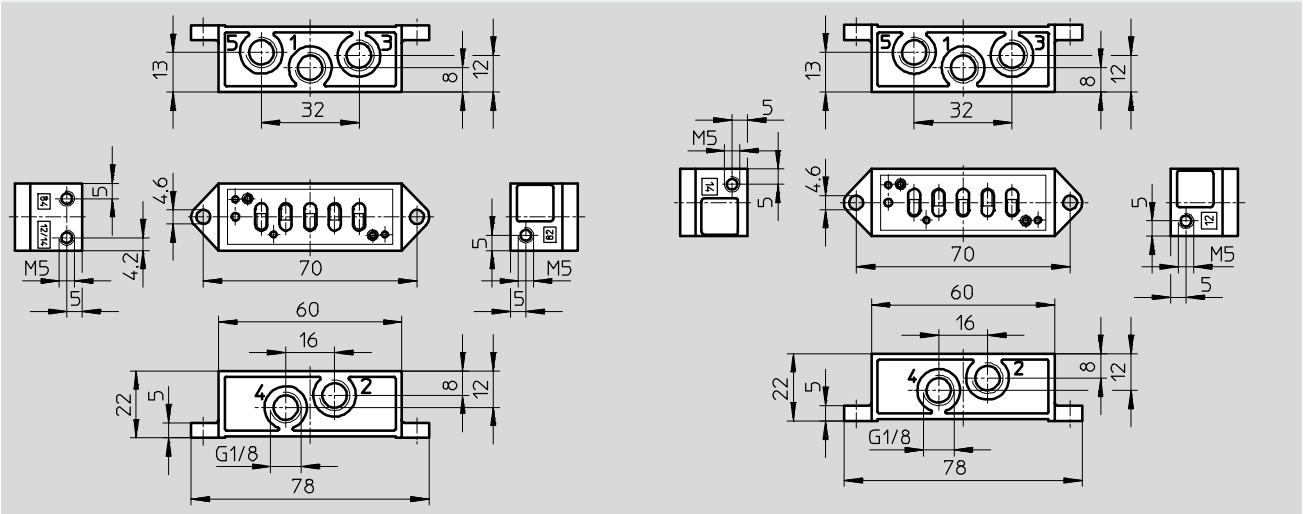

AU-ME-1/8

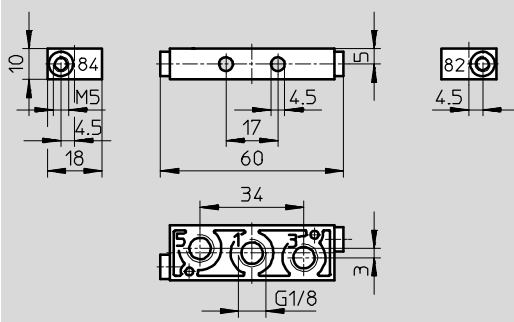

## Ordering data

Brief description		Pneumatic connection		Weight [g]	Part No.	Type
		1, 2, 3, 4, 5	82, 84			
For solenoid valves	Connection at side	G1/8	M5	50	<b>33405</b>	<b>AS-ME-1/8</b>
For pneumatic valves				50	<b>152803</b>	<b>AS-VL-1/8</b>
For valves type ...-1/8-P	Connection underneath			15	<b>32797</b>	<b>AU-ME-1/8</b>

# Solenoid/pneumatic valves, midi pneumatics

Accessories

FESTO

Series sub-bases

AW, EP, ZP

Material:

Die-cast aluminium

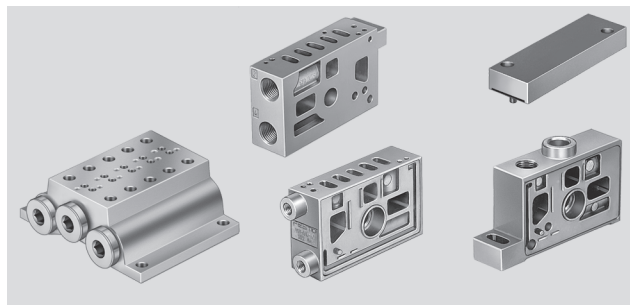

## Dimensions

Download CAD data → [www.festo.com](http://www.festo.com)

Manifold mounting

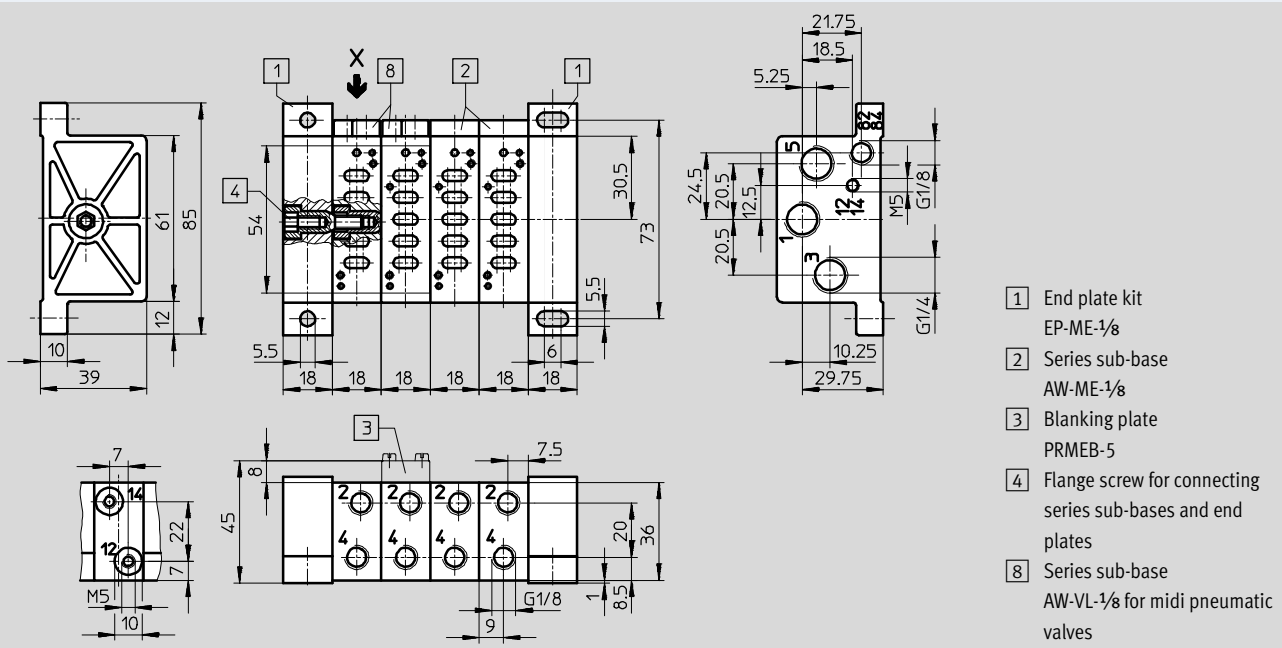

Ordering data					
Designation	Brief description	Scope of delivery	Weight [g]	Part No.	Type
Series sub-base	For solenoid valves	1 sub-base, seals and fastening screws	75	33406	AW-ME-1/8
	For pneumatic valves				152801
Blanking plate for spare positions	-	-	-	31798	PRMEB-5
End plate kit	-	2 end plates, seals and fastening screws	160	33407	EP-ME-1/8
Intermediate plate	With additional P connection	-	95	152592	ZP-ME-1/8-P
	With separate P connection to form pressure zones				152591



# Solenoid/pneumatic valves, midi pneumatics

Accessories

## Manifold PRS-ME

Material:  
Die-cast aluminium

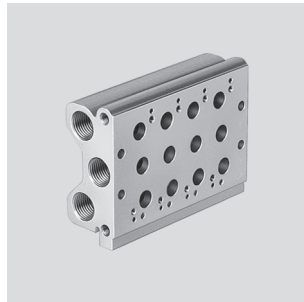

### Dimensions

Download CAD data → [www.festo.com](http://www.festo.com)

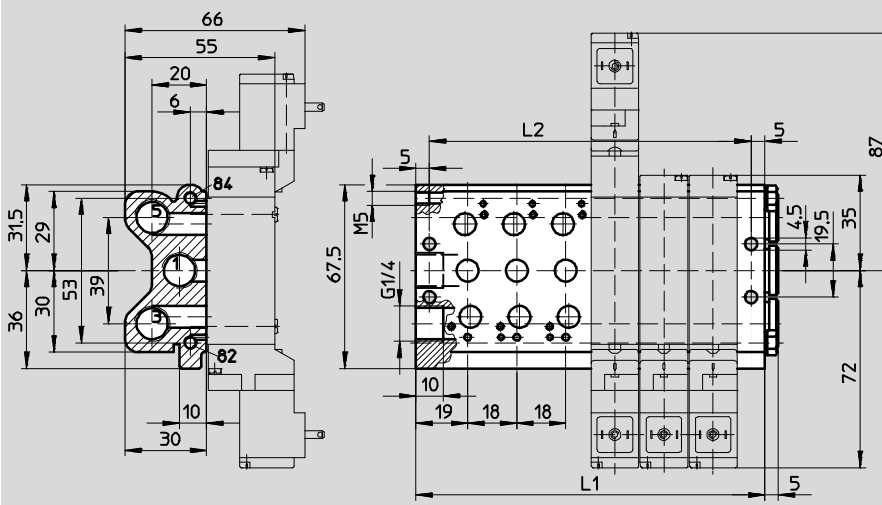

Number of valve positions	L1	L2
2	56	46
3	74	64
4	92	82

Number of valve positions	L1	L2
5	110	100
6	128	118
7	146	136

Number of valve positions	L1	L2
8	164	154
9	182	172
10	200	190

### Ordering data – Manifold block

Pneumatic connection			Number of valve positions	Weight [g]	Part No.	Type
1, 3, 5	2, 4	82, 84				
G1/4	G1/8 on valve	M5	2	200	33408	PRS-ME-1/8-2
			4	300	33409	PRS-ME-1/8-4
			6	430	33410	PRS-ME-1/8-6
			8	540	33411	PRS-ME-1/8-8
			10	680	33412	PRS-ME-1/8-10

### Ordering data – Blanking plate

Brief description	Part No.	Type
Blanking plate for spare positions	31799	PRSB-ME-1/8

- - Note



For combined assembly of series sub-bases AW-ME-1/8 and AW-VL-1/8, the following assembly sequence must be observed:





1. End plate with air supply
2. Series sub-bases for solenoid valves
3. Series sub-bases for pneumatic valves
4. End plate with flange screw

# Solenoid/pneumatic valves, midi pneumatics

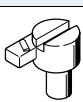
Accessories

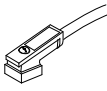

**FESTO**

Ordering data		Part No.	Type
Brief description			
<b>Push-in/threaded fittings QS</b>			
	-	→	Internet: quick star
<b>Silencers</b>			
	-	→	u
<b>Manual override tool, detenting</b>		Technical data → Internet: ahb	
	For midi valves MEH, MOEH, JMEH	<b>152797</b>	<b>AHB-ME-1/8</b>

Ordering data – Plug sockets, plug sockets with cable, illuminating seal for EB solenoid coils					
	Voltage	Cable length [m]	Switching status display with LED	Part No.	Type
<b>Plug socket without cable</b>				Technical data → Internet: mssd	
	-	-	-	<b>151687</b>	<b>MSSD-EB</b>
	-	-	-	<b>539712</b>	<b>MSSD-EB-M12</b>
<b>Plug socket without cable with insulation displacement technology</b>				Technical data → Internet: mssd	
	-	-	-	<b>192745</b>	<b>MSSD-EB-S-M14</b>
<b>PVC plug socket with cable</b>				Technical data → Internet: kmeb-1	
	24 V DC	2.5	■	<b>151688</b>	<b>KMEB-1-24-2,5-LED</b>
	24 V DC	5	■	<b>151689</b>	<b>KMEB-1-24-5-LED</b>
	24 V DC	10	■	<b>193457</b>	<b>KMEB-1-24-10-LED</b>
	Up to 240 V	2.5	-	<b>151690</b>	<b>KMEB-1-230AC-2,5</b>
	Up to 240 V	5	-	<b>151691</b>	<b>KMEB-1-230AC-5</b>
<b>PUR plug socket with cable</b>				Technical data → Internet: kmeb-2	
	24 V DC	2.5	■	<b>174844</b>	<b>KMEB-2-24-2,5-LED</b>
	24 V DC	5	■	<b>174845</b>	<b>KMEB-2-24-5-LED</b>
	Up to 240 V	2.5	-	<b>174846</b>	<b>KMEB-2-230-2,5</b>
	Up to 240 V	5	-	<b>174847</b>	<b>KMEB-2-230-5</b>
<b>Illuminating seal</b>				Technical data → Internet: meb-ld	
	12 ... 24 V DC	-	-	<b>151717</b>	<b>MEB-LD-12-24DC</b>
	230 V AC	-	-	<b>151718</b>	<b>MEB-LD-230AC</b>

# Solenoid/pneumatic valves, midi pneumatics

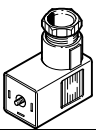
Accessories

Ordering data – Plug sockets, plug sockets with cable, illuminating seal for E solenoid coils					
	Voltage	Cable length [m]	Switching status display with LED	Part No.	Type
Plug socket without cable <span style="float: right;">Technical data → Internet: mssd</span>					
	–	–	–	<b>14098</b>	<b>MSSD-E</b>
				<b>539711</b>	<b>MSSD-E-M12</b>
Plug socket with cable <span style="float: right;">Technical data → Internet: kme</span>					
	24 V DC	2.5	■	<b>30943</b>	<b>KME-1-24DC-2,5-LED</b>
		5	■	<b>30945</b>	<b>KME-1-24DC-5-LED</b>
		10	■	<b>193455</b>	<b>KME-1-24DC-10-LED</b>
Illuminating seal <span style="float: right;">Technical data → Internet: me-ld</span>					
	24 V DC	–	–	<b>19141</b>	<b>ME-LD-12-24DC</b>

# Festo - Your Partner in Automation



**1 Festo Inc.**  
5300 Explorer Drive  
Mississauga, ON L4W 5G4  
Canada

**Festo Customer Interaction Center**  
Tel: 1 877 463 3786  
Fax: 1 877 393 3786  
Email: [customer.service.ca@festo.com](mailto:customer.service.ca@festo.com)



**2 Festo Pneumatic**  
Av. Ceylán 3,  
Col. Tequesquináhuac  
54020 Tlalnepantla,  
Estado de México

**Multinational Contact Center**  
01 800 337 8669  
[ventas.mexico@festo.com](mailto:ventas.mexico@festo.com)



**3 Festo Corporation**  
1377 Motor Parkway  
Suite 310  
Islandia, NY 11749

**Festo Customer Interaction Center**  
1 800 993 3786  
1 800 963 3786  
[customer.service.us@festo.com](mailto:customer.service.us@festo.com)



**4 Regional Service Center**  
7777 Columbia Road  
Mason, OH 45040

Connect with us



[www.festo.com/socialmedia](http://www.festo.com/socialmedia)



[www.festo.com](http://www.festo.com)

Subject to change