

Standards-based cylinders DSBF-C, ISO 15552, clean design

FESTO



Characteristics

At a glance



- Standards-based cylinders to ISO 15552 (corresponds to the withdrawn standards ISO 6431, DIN ISO 6431, VDMA24562, NFE49003.1 and UNI 10290)

- The standards-based cylinder is used wherever hygiene, ease of cleaning and resistance are important, predominantly in dry and splash zones in the food and packaging industry.
- For hygiene reasons, the threads on the cylinder caps should be sealed with suitable plug screws (available as accessories → page 31)

- Resistant to conventional cleaning agents
- Increased corrosion protection
- Three types of cushioning available:
 - Elastic cushioning elastic cushioning rings/plates at both ends
 - PPS cushioning: pneumatic cushioning, self-adjusting at both ends
 - PPV cushioning: pneumatic cushioning, adjustable at both ends

- The variants can be configured according to individual needs using a modular product system
- Excellent flexibility thanks to a wide range of variants
- Comprehensive range of mounting accessories for just about every type of installation
- Contactless position sensing via proximity switches

The technology in detail

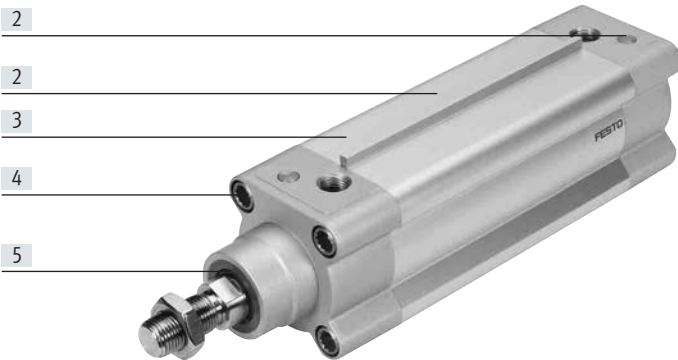

- [1] Hygienic and self-adjusting PPS cushioning
- [2] Easy-to-clean cylinder profile without corners and indents
- [3] Corrosion-resistant cylinder surface
- [4] Standard dimensions and mounting accessories to ISO 15552
- [5] NSF-H1 lubricant and special wiper seal (characteristic A3) suitable for contact in the food area. Long service life even with insufficient lubrication due to frequent cleaning processes

Longer service life with bellows kit DADB

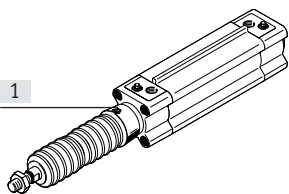













The bellows protects the piston rod, the seal and the bearing from the effects of a wide range of media, which has a positive impact on the service life of these components.

The bellows kit is a leak-free system. To prevent unwanted media from being drawn in, the supply and exhaust air for the kit must be ducted via a pressure compensation hole in the connection part [1].

The kit protects the piston rod, seal and bearing against a wide variety of media, for example:

- Dust
- Chippings
- Oil
- Grease
- Fuel

Characteristics

Variants from the modular product system		
Symbol	Characteristics	Description
	L Low friction	<ul style="list-style-type: none"> • Break-away pressure: high • Dynamic response: very fast • Resistance: minimal resistance during movement, maximum stick-slip Application example: belt tensioner <ul style="list-style-type: none"> • Suitable for applications that require dynamic movement • Efficient at speeds above 50 mm/s
	U Constant, slow movement	<ul style="list-style-type: none"> • Break-away pressure: low • Dynamic response: slow and constant • Resistance: strong resistance during movement, minimal stick-slip Application example: slow feed motion <ul style="list-style-type: none"> • Suitable for slow movements at a constant speed over the stroke range
	T Through piston rod	For working at both ends with the same force in the forward and return stroke, for attaching external stops
	F Female piston rod thread	–
	T1 Heat-resistant seals	Temperature range 0 ... +120°C
	T3 Low temperature	Temperature range –40 ... +80°C
	T4 Heat-resistant seals	Temperature range 0 ... +150°C
	A1 Wiper seal variant	Increased chemical resistance: for longer service life, e.g. when using cooling lubricants.
	A2 Wiper seal variant	Hard wiper: The cylinder is equipped with a hard-chromium plated piston rod and a hard wiper seal, which protects against dry, dusty media
	A3 Wiper seal variant	Unlubricated operation: Cleaning processes degrease the piston rod. A special piston rod seal designed for unlubricated operation permits a longer service life compared to the standard seal
	...E Extended piston rod	–
	...L Extended piston rod thread	–

Product range overview

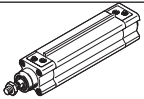
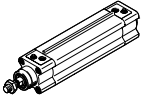
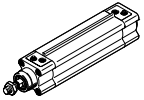
Function	Design	Type	Piston diameter	Stroke	Through piston rod	Female piston rod thread	Cushioning			
			[mm]	[mm]						T
Double-acting	DSBF-...									
		DSBF-...	32, 40, 50, 63, 80, 100, 125	1 ... 2800	■	■	■	■	■	
	DSBF-...-L, low friction									
		DSBF-...-L	32, 40, 50, 63, 80, 100	1 ... 2800	-	■	■	■	■	
DSBF-...-U, constant, slow movement										
		DSBF-...-U	32, 40, 50, 63, 80, 100, 125	1 ... 2800	-	■	■	■	■	

Product range overview

Type	Position sensing	Temperature range 0 ... +120°C	Temperature range -40 ... +80°C	Temperature range 0 ... +150°C	Wiper seal variant: increased chemical resistance	Wiper seal variant: hard wiper seal	Wiper seal variant for unlubricated operation	EU certification	Extended piston rod	Extended piston rod thread	Sensor mounting
	A	T1	T3	T4	A1	A2	A3	EX4	...E	...L	R
DSBF-...											
DSBF-...	■	■	■	■	■	■	■	■	■	■	■
DSBF-...-L, low friction											
DSBF-...-L	■	-	-	-	-	-	-	-	■	■	■
DSBF-...-U, constant, slow movement											
DSBF-...-U	■	-	-	-	-	-	-	-	■	■	■

Peripherals overview

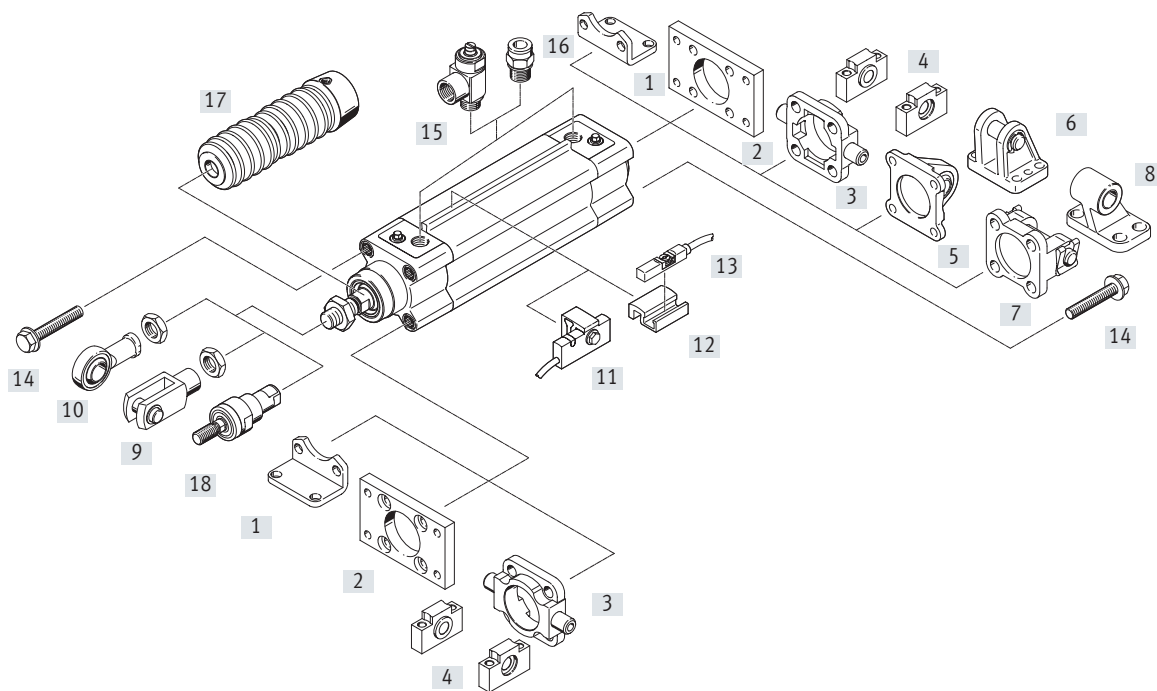

Mounting components and accessories		Description	→ Page/Internet
[1]	Foot mounting CRHNC	For bearing and end caps	20
[2]	Flange mounting CRFNG	<ul style="list-style-type: none"> For bearing or end caps Cannot be used on the bearing cap in combination with the bellows kit DADB 	20
[3]	Trunnion flange CRZNG	<ul style="list-style-type: none"> For bearing or end caps in combination with trunnion supports CRLNZG Cannot be used on the bearing cap in combination with the bellows kit DADB 	21
[4]	Trunnion support CRLNZG	For swivel mounting CRZNG	21
[5]	Swivel flange SNCS/CRSNCS/SNCS- ... -R3	With spherical bearing for end caps	23
[6]	Clevis foot LBG/LBG-R3	–	24
[7]	Swivel flange SNCB- ... -R3	For end caps	22
[8]	Clevis foot CRLNG	For swivel flange SNCB- ... -R3	24
[9]	Rod clevis CRSG	Permits a swivelling movement of the cylinder in one plane	24
[10]	Rod eye CRSGS	With spherical bearing	24
[11]	Proximity switch SMT-C1	<ul style="list-style-type: none"> For sensing the piston rod position Proximity switch is mounted on the sensor mounting rail 	29
[12]	Mounting kit SMB-8-C	<ul style="list-style-type: none"> For mounting the proximity switch CRSMT-8M Mounting kit is mounted on the sensor mounting rail 	29
[13]	Proximity switch CRSMT-8M	For sensing the piston rod position	29
[14]	Plug screw DAMD	For covering unused mounting threads	31
[15]	One-way flow control valve CRGRLA	For speed regulation	31
[16]	Push-in fitting NPQH/CRQS/CRQSL	For connecting compressed air tubing with standard O.D.	30
[17]	Bellows kit DADB	<ul style="list-style-type: none"> Protects the cylinder (piston rod, seal and bearing) against a wide range of media and thus prevents premature wear The kit can only be used in combination with an extended piston rod (characteristic: ...E) 	25
[18]	Self-aligning rod coupler CRFK	For compensating radial and angular deviations	24

Type codes

001	Series	
DSBF	Standards-based cylinder, double-acting, based on ISO 15552, clean design	
002	Product version	
C	Easy-to-clean design	
003	Running characteristics	
	Standard	
L	Low friction	
U	Uniform, slow movement	
004	Piston diameter	
32	32	
40	40	
50	50	
63	63	
80	80	
100	100	
125	125	
005	Stroke	
...	25 ... 500	
006	Piston rod type	
	At one end	
T	Through piston rod	
007	Piston rod thread type	
	Male thread	
F	Female thread	
008	Cushioning	
P	Elastic cushioning rings/plates on both sides	
PPV	Pneumatic cushioning, adjustable at both ends	
PPS	Pneumatic cushioning, self-adjusting at both ends	
009	Position sensing	
A	For proximity sensor	
010	Standard	
	Not according to standard	
N3	Conforms to ISO 15552	
011	Temperature range	
	Standard	
T1	Heat-resistant seals max. 120°C	
T3	-40 ... +80°C	
T4	0 ... +150°C	
012	Scraper variant	
	None	
A1	Increased chemical resistance	
A2	Hard scraper	
A3	For unlubricated operation	
013	EU certification	
	None	
EX4	II 2GD	
014		
	None	
...E	1...500 mm	
015	Piston rod thread extension	
	None	
...L	1...70 mm	
016	Sensor mounting, external	
R	Mounting rail for sensors	

Data sheet

Function
Elastic cushioning

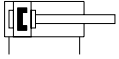

PPV cushioning

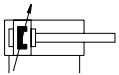

PPS cushioning

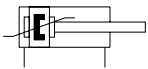

⌀ - Diameter
32 ... 125 mm

- | - Stroke length 1 ... 2800 mm

 www.festo.com

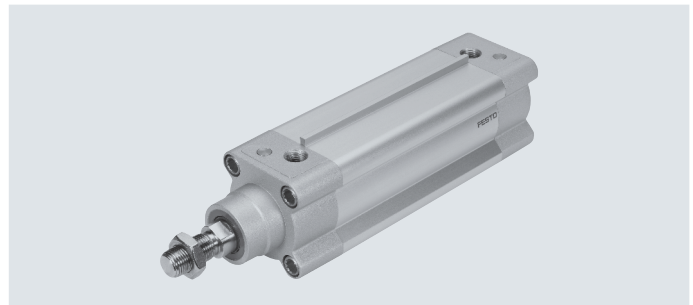

General technical data								
Piston diameter		32	40	50	63	80	100	125
Pneumatic connection		G1/8	G1/4	G1/4	G3/8	G3/8	G1/2	G1/2
Piston rod thread		M10x1.25	M12x1.25	M16x1.5	M16x1.5	M20x1.5	M20x1.5	M27x2
Stroke								
DSBF...	[mm]	1 ... 2800						
DSBF...-...E	[mm]	1 ... 2000						
DSBF...-...L	[mm]	1 ... 2000						
Design		Piston						
		Piston rod						
		Profile barrel						
Mode of operation		Double-acting						
Cushioning								
DSBF...-P		Elastic cushioning rings/plates at both ends						
DSBF...-PPS		Pneumatic cushioning, self-adjusting at both ends						
DSBF...-PPV		Pneumatic cushioning, adjustable at both ends						
Cushioning length								
DSBF...-PPV	[mm]	17	19	22	22	31	31	45
Position sensing		Via proximity switch						
Type of mounting		Via female thread						
		Via accessories						
Mounting position		Any						

Data sheet

Operating and environmental conditions								
Piston diameter		32	40	50	63	80	100	125
Operating medium		Compressed air to ISO 8573-1:2010 [7:4:4]						
Note on the operating/pilot medium		Lubricated operation possible (in which case lubricated operation will always be required)						
Operating pressure								
DSBF...	[MPa]	0.06 ... 1.2		0.04 ... 1.2		0.02 ... 1.0		
	[bar]	0.6 ... 12		0.4 ... 12		0.2 ... 10		
DSBF...-L ¹⁾	[MPa]	0.025 ... 1.2		0.02 ... 1.2	0.015 ... 1.2	0.01 ... 1.2		
	[bar]	0.25 ... 12		0.2 ... 12	0.15 ... 12	0.1 ... 12		
DSBF...-U ¹⁾	[MPa]	0.01 ... 1.2		0.005 ... 1.2		0.005 ... 1.0		
	[bar]	0.1 ... 12		0.05 ... 12		0.05 ... 10		
DSBF...-T3/-A2	[MPa]	0.1 ... 1.2				0.1 ... 1.0		
	[bar]	1 ... 12				1 ... 10		
DSBF...-A3	[MPa]	0.15 ... 1.2		0.1 ... 1.2	0.06 ... 1.2		0.06 ... 1.0	
	[bar]	1.5 ... 12		1 ... 12	0.6 ... 12		0.6 ... 10	
Ambient temperature ²⁾								
DSBF...	[°C]	-20 ... +80						
DSBF...-L/-A1	[°C]	0 ... +80						
DSBF...-T1	[°C]	0 ... +120						
DSBF...-T3	[°C]	-40 ... +80						
DSBF...-T4	[°C]	0 ... +150						
DSBF...-EX4	[°C]	-20 ... +60						
Food-safe ³⁾		→ supplementary material information						
Corrosion resistance CRC ⁴⁾		3						

1) Values apply only for strokes ≤ 500 mm and after 10 double strokes.

In combination with cushioning PPV/PPS, the specifications only apply outside the cushioning range

2) Note operating range of proximity switches.

3) Additional information is available at www.festo.com/sp → Certificates.

4) Corrosion resistance class CRC 3 to Festo standard FN 940070

High corrosion stress. Outdoor exposure under moderate corrosive conditions. Externally visible parts with primarily functional surface requirements which are in direct contact with a normal industrial environment.

ATEX ¹⁾	
ATEX category for gas	II 2G
Type of ignition protection for gas	Ex h IIC T4 Gb
ATEX category for dust	II 2D
Type of ignition protection for dust	Ex h IIIC T120°C Db
Explosion-proof ambient temperature	-20°C ≤ Ta ≤ +60°C
CE marking (see declaration of conformity)	To EU Explosion Protection Directive (ATEX)
UKCA marking (see declaration of conformity)	To UK EX instructions
Explosion protection certification outside the EU	EPL Gb (GB)
	EPL Db (GB)

1) Note the ATEX certification of the accessories.

Forces [N] and impact energy [J]								
Piston diameter		32	40	50	63	80	100	125
Theoretical force at 6 bar, advancing		483	754	1178	1870	3016	4712	7363
Theoretical force at 6 bar, retracting		415	633	990	1682	2721	4418	6881
Max. impact energy in the end positions								
DSBF...		0.4	0.7	1.0	1.3	1.8	2.5	3.3
DSBF...-L/-U/-T1/-T3/-T4		0.2	0.35	0.5	0.65	0.9	1.25	1.65

Permissible impact velocity:
$$V = \sqrt{\frac{2 \times E}{m_1 + m_2}}$$

Maximum permissible mass:
$$m_2 = \frac{2 \times E}{v^2} - m_1$$

V Permissible impact velocity
E Max. impact energy
m1 Moving mass (drive)
m2 Moving payload

Data sheet

Weight [g]							
Piston diameter	32	40	50	63	80	100	125
DSBF...							
Product weight with 0 mm stroke	472	778	1241	1803	3131	4551	6928
Additional weight per 10 mm stroke	28	40	58	65	95	106	163
Moving mass with 0 mm stroke	108	204	363	460	800	1045	2245
Moving mass per 10 mm stroke	9	16	25	25	39	39	63
DSBF...-T							
Product weight with 0 mm stroke	588	962	1574	2166	3714	5239	7767
Additional weight per 10 mm stroke	35	53	83	89	136	146	226
Moving mass with 0 mm stroke	179	338	611	714	1282	1561	3084
Moving mass per 10 mm stroke	18	32	50	50	78	78	126

Materials

Sectional view

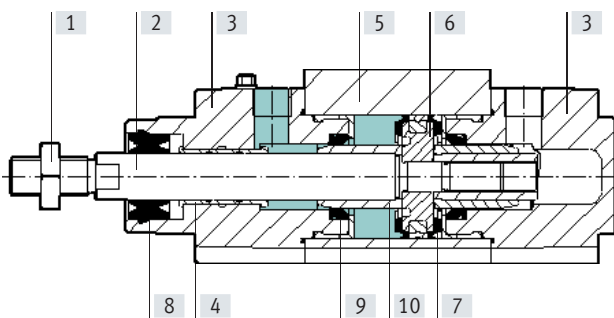

Standards-based cylinder

[1] Nut	High-alloy stainless steel
[2] Piston rod	High-alloy stainless steel
[3] Cover	Coated die-cast aluminium
[4] Bearing	
DSBF...	POM
DSBF...-A2	Bronze
DSBF...-L/-U/-T1/-T4	Metal polymer compound
[5] Cylinder barrel	Anodised wrought aluminium alloy
[6] Piston	Anodised wrought aluminium alloy
[7] Piston seal	
DSBF...	TPE-U(PU)
DSBF...-L/-U/-T1/-T4	FPM
DSBF...-T3	TPE-U(PU) (suitable for low temperatures)
[8] Piston rod wiper seal	
DSBF...	TPE-U (PU) media seal (modified for resistance to hydrolysis and cleaning)
DSBF...-L/-U/-T1/-T4/-A1	FPM
DSBF...-T3	TPE-U (PU) (suitable for low temperatures)
DSBF...-A3	UHMW-PE
[9] Buffer seal	
DSBF...	TPE-U (PU)
DSBF...-U/-T1/-T4/-A1	FPM
DSBF...-T3	TPE-U (PU) (suitable for low temperatures)
[10] Cushion piston	
DSBF...	POM
DSBF...-T1/-T3/-T4	Aluminium
- Flange screw	Galvanised steel
Note on materials	
DSBF...	RoHS-compliant
DSBF...-L/-U/-T1/-T3/-T4/-A1/-A3	Contains paint-wetting impairment substances

Data sheet

Max. transverse load F_q as a function of stroke length l

Horizontal installation

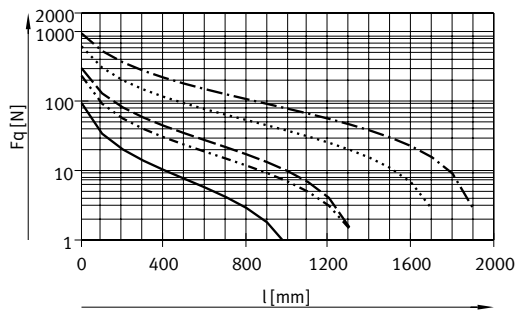

- Diameter 32
- · - · - · Diameter 40
- - - - - Diameter 50/63
- · · · · Diameter 80/100
- · - · - · Diameter 125

Vertical installation

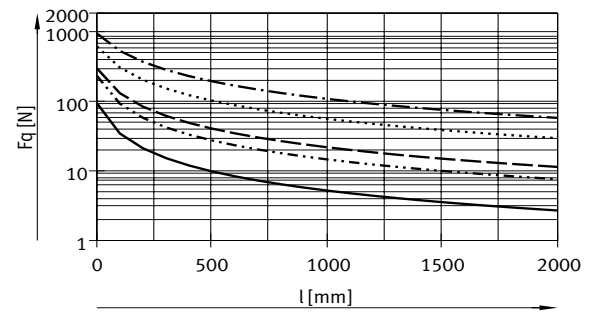

- Diameter 32
- · - · - · Diameter 40
- - - - - Diameter 50/63
- · · · · Diameter 80/100
- · - · - · Diameter 125

End-position sensing

A minimum stroke is required to be able to sense both end positions at the cylinder. [1] Position of the proximity switch within the housing.

With proximity switch SMT-C1

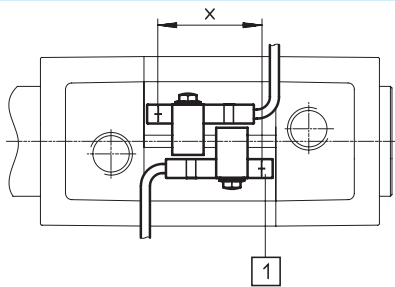

Piston diameter		32	40	50	63 ... 125
Minimum stroke x	[mm]	18	17	13	10

With mounting kit SMB-8-C and proximity switch CRSMT-8M

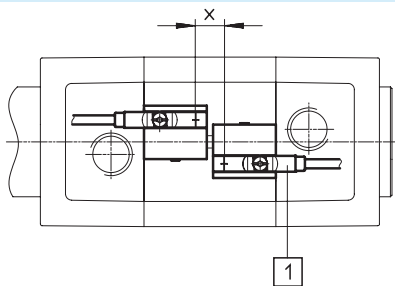

Piston diameter		32 ... 125
Minimum stroke x	[mm]	10

Data sheet

Dimensions

Download CAD data → www.festo.com

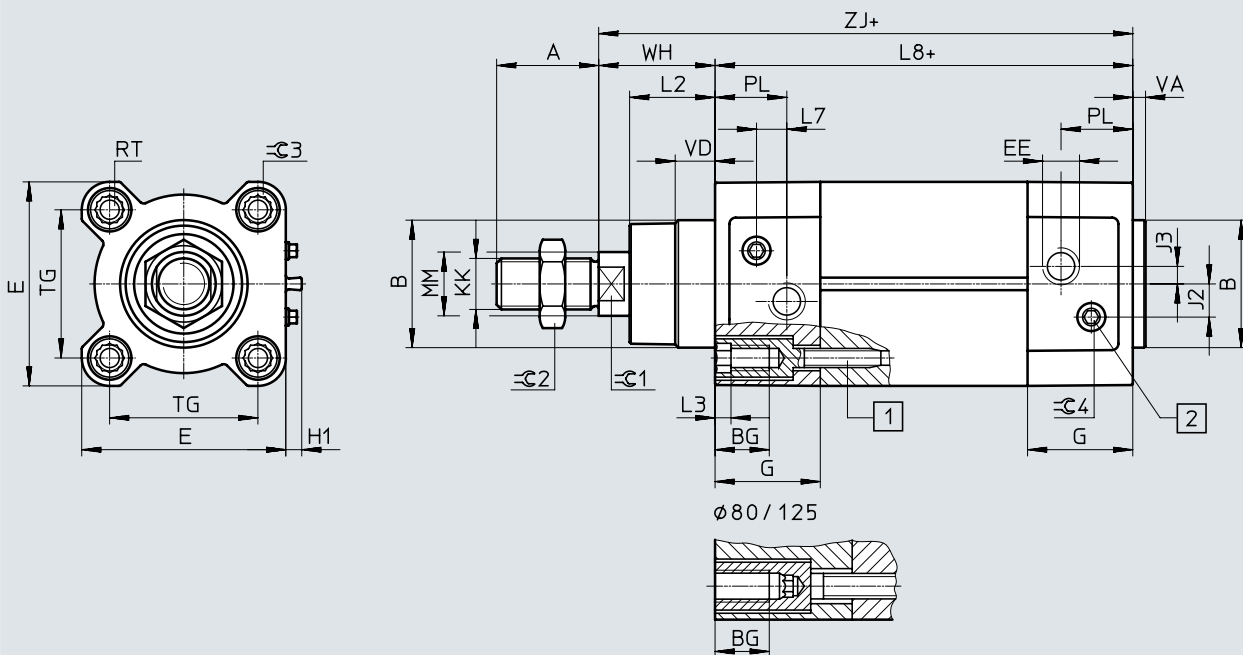

- + = plus stroke length
- [1] Socket head screw with female thread for mounting components
- [2] Adjusting screw for adjustable end-position cushioning

Data sheet

∅ [mm]	A -0.5	B ∅ d11	BG min.	E +0.5	EE	G -0.2	H1 ±0.2	J2 ±0.1	J3 ±0.1
32	22	30	16	45	G1/8	28	5	5.7	5.3
40	24	35	16	54	G1/4	33	5	8	4
50	32	40	16	64	G1/4	33	5	10.4	5.5
63	32	45	16	75	G3/8	40.5	5	12.75	6.3
80	40	45	17	93	G3/8	43	5	12.5	8
100	40	55	17	110	G1/2	48	5	13.5	10
125	54	60	20	136	G1/2	44.7	5	13	8

∅ [mm]	KK	L2	L3 max.	L7	L8 ±0.4	MM ∅	PL ±0.1	RT	TG ±0.3
32	M10x1.25	18 _{-0.2}	5	6.5	94	12	19.5	M6	32.5
40	M12x1.25	21.3 _{-0.2}	5	7.5	105	16	22.5	M6	38
50	M16x1.5	26.8 _{-0.2}	5	9.5	106	20	22.5	M8	46.5
63	M16x1.5	27 _{-0.2}	5	9	121	20	27.5	M8	56.5
80	M20x1.5	34.2 _{-0.2}	-	11	128	25	30	M10	72
100	M20x1.5	38 _{-0.2}	-	7.5	138	25	31.5	M10	89
125	M27x2	45.5 _{-0.3}	-	10	160	32	22.5	M12	110

∅ [mm]	VA	VD +0.5	WH +2.2	ZJ +1.8	≅G1	≅G2	≅G3	≅G4
32	4 _{-0.2}	10	25	119.1	10	17	6	4
40	4 _{-0.2}	10.5	28.7	133.9	13	19	6	4
50	4 _{-0.2}	11.5	35.6	141.8	17	24	8	4
63	4 _{-0.2}	15	35.9	157.1	17	24	8	4
80	4 _{-0.2}	15.7	45.4	173.6	22	30	6	4
100	4 _{-0.2}	19.2	49.3	187.5	22	30	6	5
125	6 _{-0.3}	20.5	64.1	225	27	41	8	5

Data sheet

Dimensions – Variants

Download CAD data → www.festo.com

T – Through piston rod

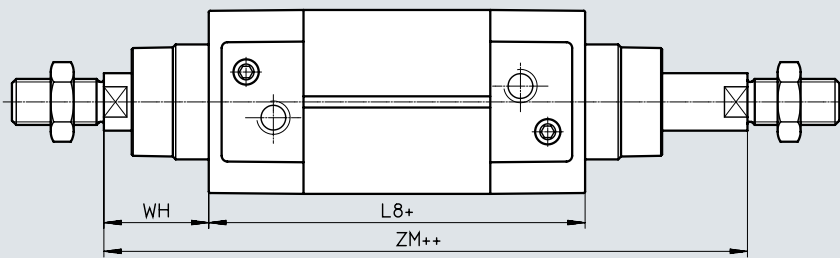

+ = plus stroke length
++ = plus 2x stroke length

F – Female piston rod thread

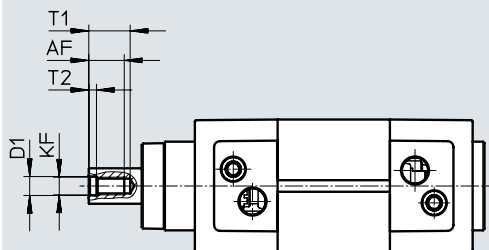

-  - **Note**

In combination with variant T, the piston rod has female threads at both ends.

...E – Extended piston rod

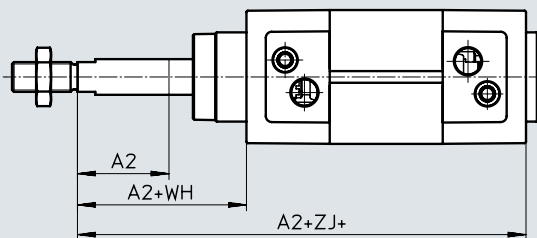

-  - **Note**

In combination with variant T, the piston rod is extended at one end.

...L – Extended piston rod thread

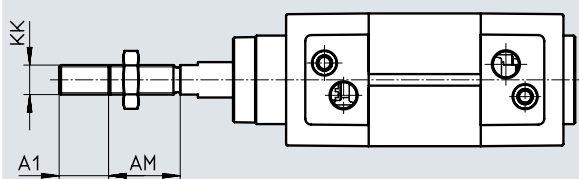

-  - **Note**

In combination with variant T, the piston rod thread is extended at both ends.

Data sheet

∅ [mm]	A1 max.	A2 max.	AM -0.5	AF	D1	KF
32	35	500	22	12	6.4 ^{+0.2}	M6
40			24	12	8.4 ^{+0.2}	M8
50	70		32	16	10.5 ^{+0.2}	M10
63			32	16	10.5 ^{+0.2}	M10
80			40	20	13 ^{+0.1}	M12
100			40	20	13 ^{+0.1}	M12
125			54	32	17 ^{+0.1}	M16

∅ [mm]	KK	L8 ±0.4	T1	T2 +0.2	WH +2.2	ZJ +1.8	ZM +1
32	M10x1.25	94	16	2.6	26	119.1	146.1
40	M12x1.25	105	16	3.3	28.7	133.9	164.8
50	M16x1.5	106	21	4.7	35.6	141.8	179.8
63	M16x1.5	121	21	4.7	35.9	157.1	195.4
80	M20x1.5	128	26.5	6.1	45.4	173.6	221
100	M20x1.5	138	26.5	6.1	49.3	187.5	238.8
125	M27x2	160	40	8	65	225	290

Data sheet

Ordering data		PPS – Pneumatic cushioning, self-adjusting at both ends		PPV – Pneumatic cushioning, adjustable at both ends	
Piston diameter	Stroke	A – With position sensing		A – With position sensing	
[mm]	[mm]	Part no.	Type	Part no.	Type
Basic type					
32	25	1778834	DSBF-C-32-25-PPSA-N3-R	1773752	DSBF-C-32-25-PPVA-N3-R
	40	1778835	DSBF-C-32-40-PPSA-N3-R	1773753	DSBF-C-32-40-PPVA-N3-R
	50	1778836	DSBF-C-32-50-PPSA-N3-R	1773754	DSBF-C-32-50-PPVA-N3-R
	80	1778837	DSBF-C-32-80-PPSA-N3-R	1773755	DSBF-C-32-80-PPVA-N3-R
	100	1778838	DSBF-C-32-100-PPSA-N3-R	1773756	DSBF-C-32-100-PPVA-N3-R
	125	1778839	DSBF-C-32-125-PPSA-N3-R	1773757	DSBF-C-32-125-PPVA-N3-R
	160	1778840	DSBF-C-32-160-PPSA-N3-R	1773758	DSBF-C-32-160-PPVA-N3-R
	200	1778841	DSBF-C-32-200-PPSA-N3-R	1773759	DSBF-C-32-200-PPVA-N3-R
	250	1778842	DSBF-C-32-250-PPSA-N3-R	1773760	DSBF-C-32-250-PPVA-N3-R
	320	1778843	DSBF-C-32-320-PPSA-N3-R	1773761	DSBF-C-32-320-PPVA-N3-R
	400	1778844	DSBF-C-32-400-PPSA-N3-R	1773762	DSBF-C-32-400-PPVA-N3-R
500	1778845	DSBF-C-32-500-PPSA-N3-R	1773763	DSBF-C-32-500-PPVA-N3-R	
40	25	1779431	DSBF-C-40-25-PPSA-N3-R	1774259	DSBF-C-40-25-PPVA-N3-R
	40	1779432	DSBF-C-40-40-PPSA-N3-R	1774260	DSBF-C-40-40-PPVA-N3-R
	50	1779433	DSBF-C-40-50-PPSA-N3-R	1774261	DSBF-C-40-50-PPVA-N3-R
	80	1779434	DSBF-C-40-80-PPSA-N3-R	1774262	DSBF-C-40-80-PPVA-N3-R
	100	1779435	DSBF-C-40-100-PPSA-N3-R	1774263	DSBF-C-40-100-PPVA-N3-R
	125	1779436	DSBF-C-40-125-PPSA-N3-R	1774264	DSBF-C-40-125-PPVA-N3-R
	160	1779437	DSBF-C-40-160-PPSA-N3-R	1774265	DSBF-C-40-160-PPVA-N3-R
	200	1779438	DSBF-C-40-200-PPSA-N3-R	1774266	DSBF-C-40-200-PPVA-N3-R
	250	1779439	DSBF-C-40-250-PPSA-N3-R	1774267	DSBF-C-40-250-PPVA-N3-R
	320	1779440	DSBF-C-40-320-PPSA-N3-R	1774268	DSBF-C-40-320-PPVA-N3-R
	400	1779441	DSBF-C-40-400-PPSA-N3-R	1774269	DSBF-C-40-400-PPVA-N3-R
500	1779442	DSBF-C-40-500-PPSA-N3-R	1774270	DSBF-C-40-500-PPVA-N3-R	
50	25	1780283	DSBF-C-50-25-PPSA-N3-R	1775258	DSBF-C-50-25-PPVA-N3-R
	40	1780284	DSBF-C-50-40-PPSA-N3-R	1775259	DSBF-C-50-40-PPVA-N3-R
	50	1780285	DSBF-C-50-50-PPSA-N3-R	1775260	DSBF-C-50-50-PPVA-N3-R
	80	1780286	DSBF-C-50-80-PPSA-N3-R	1775261	DSBF-C-50-80-PPVA-N3-R
	100	1780287	DSBF-C-50-100-PPSA-N3-R	1775262	DSBF-C-50-100-PPVA-N3-R
	125	1780288	DSBF-C-50-125-PPSA-N3-R	1775263	DSBF-C-50-125-PPVA-N3-R
	160	1780289	DSBF-C-50-160-PPSA-N3-R	1775264	DSBF-C-50-160-PPVA-N3-R
	200	1780290	DSBF-C-50-200-PPSA-N3-R	1775265	DSBF-C-50-200-PPVA-N3-R
	250	1780291	DSBF-C-50-250-PPSA-N3-R	1775266	DSBF-C-50-250-PPVA-N3-R
	320	1780292	DSBF-C-50-320-PPSA-N3-R	1775267	DSBF-C-50-320-PPVA-N3-R
	400	1780293	DSBF-C-50-400-PPSA-N3-R	1775268	DSBF-C-50-400-PPVA-N3-R
500	1780294	DSBF-C-50-500-PPSA-N3-R	1775269	DSBF-C-50-500-PPVA-N3-R	
63	25	1780905	DSBF-C-63-25-PPSA-N3-R	1776043	DSBF-C-63-25-PPVA-N3-R
	40	1780906	DSBF-C-63-40-PPSA-N3-R	1776044	DSBF-C-63-40-PPVA-N3-R
	50	1780907	DSBF-C-63-50-PPSA-N3-R	1776045	DSBF-C-63-50-PPVA-N3-R
	80	1780908	DSBF-C-63-80-PPSA-N3-R	1776046	DSBF-C-63-80-PPVA-N3-R
	100	1780909	DSBF-C-63-100-PPSA-N3-R	1776047	DSBF-C-63-100-PPVA-N3-R
	125	1780910	DSBF-C-63-125-PPSA-N3-R	1776048	DSBF-C-63-125-PPVA-N3-R
	160	1780911	DSBF-C-63-160-PPSA-N3-R	1776049	DSBF-C-63-160-PPVA-N3-R
	200	1780912	DSBF-C-63-200-PPSA-N3-R	1776050	DSBF-C-63-200-PPVA-N3-R
	250	1780913	DSBF-C-63-250-PPSA-N3-R	1776051	DSBF-C-63-250-PPVA-N3-R
	320	1780914	DSBF-C-63-320-PPSA-N3-R	1776052	DSBF-C-63-320-PPVA-N3-R
	400	1780915	DSBF-C-63-400-PPSA-N3-R	1776053	DSBF-C-63-400-PPVA-N3-R
500	1780916	DSBF-C-63-500-PPSA-N3-R	1776054	DSBF-C-63-500-PPVA-N3-R	

Data sheet

Ordering data		PPS – Pneumatic cushioning, self-adjusting at both ends		PPV – Pneumatic cushioning, adjustable at both ends	
Piston diameter	Stroke	A – With position sensing		A – With position sensing	
[mm]	[mm]	Part no.	Type	Part no.	Type
Basic type					
80	25	1781061	DSBF-C-80-25-PPSA-N3-R	1778429	DSBF-C-80-25-PPVA-N3-R
	40	1781062	DSBF-C-80-40-PPSA-N3-R	1778430	DSBF-C-80-40-PPVA-N3-R
	50	1781063	DSBF-C-80-50-PPSA-N3-R	1778431	DSBF-C-80-50-PPVA-N3-R
	80	1781064	DSBF-C-80-80-PPSA-N3-R	1778432	DSBF-C-80-80-PPVA-N3-R
	100	1781065	DSBF-C-80-100-PPSA-N3-R	1778433	DSBF-C-80-100-PPVA-N3-R
	125	1781066	DSBF-C-80-125-PPSA-N3-R	1778434	DSBF-C-80-125-PPVA-N3-R
	160	1781067	DSBF-C-80-160-PPSA-N3-R	1778435	DSBF-C-80-160-PPVA-N3-R
	200	1781068	DSBF-C-80-200-PPSA-N3-R	1778436	DSBF-C-80-200-PPVA-N3-R
	250	1781069	DSBF-C-80-250-PPSA-N3-R	1778437	DSBF-C-80-250-PPVA-N3-R
	320	1781070	DSBF-C-80-320-PPSA-N3-R	1778438	DSBF-C-80-320-PPVA-N3-R
	400	1781071	DSBF-C-80-400-PPSA-N3-R	1778439	DSBF-C-80-400-PPVA-N3-R
	500	1781072	DSBF-C-80-500-PPSA-N3-R	1778440	DSBF-C-80-500-PPVA-N3-R
100	25	1782823	DSBF-C-100-25-PPSA-N3-R	1782253	DSBF-C-100-25-PPVA-N3-R
	40	1782824	DSBF-C-100-40-PPSA-N3-R	1782254	DSBF-C-100-40-PPVA-N3-R
	50	1782825	DSBF-C-100-50-PPSA-N3-R	1782255	DSBF-C-100-50-PPVA-N3-R
	80	1782826	DSBF-C-100-80-PPSA-N3-R	1782256	DSBF-C-100-80-PPVA-N3-R
	100	1782827	DSBF-C-100-100-PPSA-N3-R	1782257	DSBF-C-100-100-PPVA-N3-R
	125	1782828	DSBF-C-100-125-PPSA-N3-R	1782258	DSBF-C-100-125-PPVA-N3-R
	160	1782829	DSBF-C-100-160-PPSA-N3-R	1782259	DSBF-C-100-160-PPVA-N3-R
	200	1782830	DSBF-C-100-200-PPSA-N3-R	1782260	DSBF-C-100-200-PPVA-N3-R
	250	1782831	DSBF-C-100-250-PPSA-N3-R	1782261	DSBF-C-100-250-PPVA-N3-R
	320	1782832	DSBF-C-100-320-PPSA-N3-R	1782262	DSBF-C-100-320-PPVA-N3-R
	400	1782833	DSBF-C-100-400-PPSA-N3-R	1782263	DSBF-C-100-400-PPVA-N3-R
	500	1782834	DSBF-C-100-500-PPSA-N3-R	1782264	DSBF-C-100-500-PPVA-N3-R
125	25	1792953	DSBF-C-125-25-PPSA-N3-R	1785012	DSBF-C-125-25-PPVA-N3-R
	40	1792954	DSBF-C-125-40-PPSA-N3-R	1785013	DSBF-C-125-40-PPVA-N3-R
	50	1792955	DSBF-C-125-50-PPSA-N3-R	1785014	DSBF-C-125-50-PPVA-N3-R
	80	1792956	DSBF-C-125-80-PPSA-N3-R	1785015	DSBF-C-125-80-PPVA-N3-R
	100	1792957	DSBF-C-125-100-PPSA-N3-R	1785016	DSBF-C-125-100-PPVA-N3-R
	125	1792958	DSBF-C-125-125-PPSA-N3-R	1785017	DSBF-C-125-125-PPVA-N3-R
	160	1792959	DSBF-C-125-160-PPSA-N3-R	1785018	DSBF-C-125-160-PPVA-N3-R
	200	1792960	DSBF-C-125-200-PPSA-N3-R	1785019	DSBF-C-125-200-PPVA-N3-R
	250	1792961	DSBF-C-125-250-PPSA-N3-R	1785020	DSBF-C-125-250-PPVA-N3-R
	320	1792962	DSBF-C-125-320-PPSA-N3-R	1785021	DSBF-C-125-320-PPVA-N3-R
	400	1792963	DSBF-C-125-400-PPSA-N3-R	1785022	DSBF-C-125-400-PPVA-N3-R
	500	1792964	DSBF-C-125-500-PPSA-N3-R	1785023	DSBF-C-125-500-PPVA-N3-R

 **Note**

Other variants in the modular product system → page 19

Data sheet

Ordering data			
Piston diameter	Stroke	PPS – Pneumatic cushioning, self-adjusting at both ends A – With position sensing	PPV – Pneumatic cushioning, adjustable at both ends A – With position sensing
[mm]	[mm]	Part no. Type	Part no. Type
Variable stroke			
32	1 ... 2800	1778516 DSBF-C-32-...-PPSA-N3-R	1772262 DSBF-C-32-...-PPVA-N3-R
40	1 ... 2800	1779309 DSBF-C-40-...-PPSA-N3-R	1774182 DSBF-C-40-...-PPVA-N3-R
50	1 ... 2800	1779742 DSBF-C-50-...-PPSA-N3-R	1774418 DSBF-C-50-...-PPVA-N3-R
63	1 ... 2800	1780600 DSBF-C-63-...-PPSA-N3-R	1775324 DSBF-C-63-...-PPVA-N3-R
80	1 ... 2800	1780945 DSBF-C-80-...-PPSA-N3-R	1778184 DSBF-C-80-...-PPVA-N3-R
100	1 ... 2800	1781567 DSBF-C-100-...-PPSA-N3-R	1781598 DSBF-C-100-...-PPVA-N3-R
125	1 ... 2800	1792703 DSBF-C-125-...-PPSA-N3-R	1784637 DSBF-C-125-...-PPVA-N3-R

 **Note**

Other variants in the modular product system → page 19

Ordering data – Modular product system

	32	40	50	63	80	100	125	Condi- tions	Code	Enter code	
Module no.	570077	570078	570079	570080	570081	570082	1755169				
Function	Standards-based cylinder, clean design								DSBF	DSBF	
Product version	Easy-to-clean design								-C	-C	
Running characteristics	Standard										
	Low friction							–	[1]	L	
	Constant, slow movement								[1]	U	
Piston diameter [mm]	32	40	50	63	80	100	125		-...		
Stroke [mm]	1 ... 2800									-...	
Piston rod type	At one end										
	Through piston rod									-T	
Piston rod thread type	Male thread										
	Female thread								[2]	F	
Cushioning	Elastic cushioning rings/plates at both ends									-P	
	Pneumatic cushioning, self-adjusting at both ends								[3]	-PPS	
	Pneumatic cushioning, adjustable at both ends									-PPV	
Position sensing	Via proximity switch									A	A
Standard	Conforms to ISO15552									-N3	
Temperature range	Standard –20 ... +80°C										
	Heat-resistant seals 0 ... +120°C								[4]	T1	
	–40 ... +80°C								[4]	T3	
	0 ... +150°C								[4]	T4	
Wiper seal variant	None										
	Increased chemical resistance								[5]	A1	
	Hard wiper									A2	
	For unlubricated operation								[5]	A3	
EU certification	None										
	II 2GD							–		EX4	
Extended piston rod [mm]	1 ... 500								[6]	-...E	
Extended piston rod thread [mm]	1 ... 35			1 ... 70					[6]	-...L	
Sensor mounting	Mounting rail for sensors									-R	-R

[1] L, U Not with T, T1, T3, T4, A1, A2, A3 and EX4

[2] F Not with ...L

[3] PPS Not with T1, T3, T4, A1

[4] T1, T3, T4 Not with A1, A2, A3, EX4

[5] A1, A3 Not with EX4

[6] ...E, ...L Only up to stroke 2000 mm

Not with N3

Accessories

Foot mounting CRHNC

Material:
High-alloy steel
Free of copper and PTFE

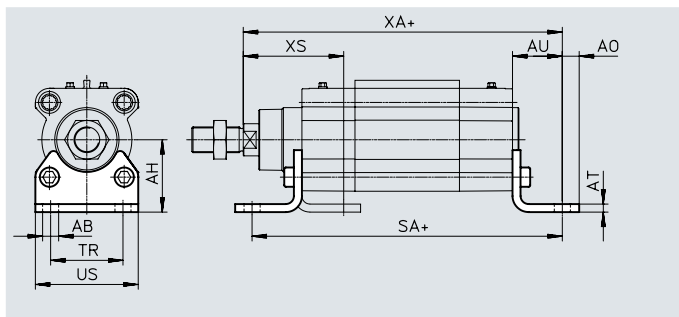

Dimensions and ordering data

For \varnothing [mm]	AB \varnothing	AH	AO	AT	AU	SA	TR	US	XA	XS	CRC ¹⁾	Weight [g]	Part no.	Type ²⁾
32	7	32	6.5	4	24	142	32	45	143.1	46	4	139	176937	CRHNC-32
40	10	36	9	4	28	161	36	54	161.9	52.7	4	188	176938	CRHNC-40
50	10	45	9.5	5	32	170	45	64	173.8	62.6	4	341	176939	CRHNC-50
63	10	50	12.5	5	32	185	50	75	189.1	62.9	4	424	176940	CRHNC-63
80	12	63	15	6	41	210	63	93	214.6	80.4	4	810	176941	CRHNC-80
100	14.5	71	17.5	6	41	220	75	110	228.5	84.3	4	990	176942	CRHNC-100
125	16.5	90	22	8	45	250	90	131	270	102	4	1920	176943	CRHNC-125

- 1) Corrosion resistance class CRC 4 to Festo standard FN 940070
Particularly high corrosion stress. Outdoor exposure under extreme corrosive conditions. Parts exposed to aggressive media, e.g. in the chemical or food industries. Such applications may need to be safeguarded by special tests (→ also FN 940082), using appropriate media.
- 2) Suitable for ATEX

Flange mounting CRFNG

Material:
High-alloy steel
Free of copper and PTFE

Cannot be used on the bearing cap in combination with the bellows kit DADB.

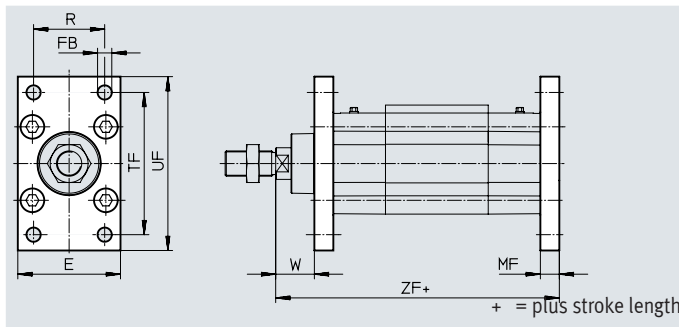
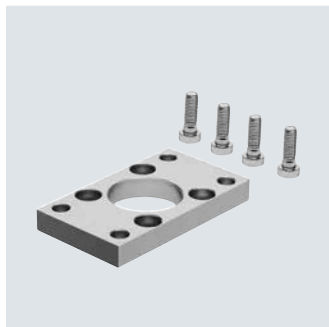

Dimensions and ordering data

For \varnothing [mm]	E	FB \varnothing	MF	R	TF	UF	W	ZF	CRC ¹⁾	Weight [g]	Part no.	Type ²⁾
32	45	7	10	32	64	80	16	129.1	4	220	161846	CRFNG-32
40	54	9	10	36	72	90	18.7	143.9	4	291	161847	CRFNG-40
50	64	9	12	45	90	110	23.6	153.8	4	526	161848	CRFNG-50
63	75	9	12	50	100	120	23.9	169.1	4	680	161849	CRFNG-63
80	93	12	16	63	126	150	29.4	189.6	4	1508	161850	CRFNG-80
100	110	14	16	75	150	175	33.3	203.5	4	2054	161851	CRFNG-100
125	132	16	20	90	180	210	45	245	4	3787	185363	CRFNG-125

- 1) Corrosion resistance class CRC 4 to Festo standard FN 940070
Particularly high corrosion stress. Outdoor exposure under extreme corrosive conditions. Parts exposed to aggressive media, e.g. in the chemical or food industries. Such applications may need to be safeguarded by special tests (→ also FN 940082), using appropriate media.
- 2) Suitable for ATEX

Accessories

Trunnion flange CRZNG

Material:
High-alloy steel
Free of copper and PTFE

Cannot be used on the bearing cap in combination with the bellows kit DADB.

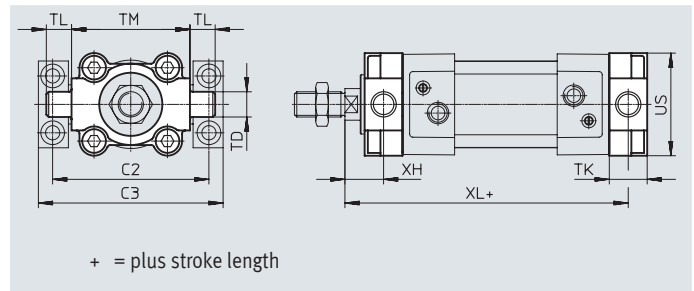

Dimensions and ordering data													
For \varnothing [mm]	C2	C3	TD \varnothing e9	TK	TL	TM	UW	XH	XL	CRC ¹⁾	Weight [g]	Part no.	Type ²⁾
32	71	86	12	16	12	50	45	18	127.1	4	150	161852	CRZNG-32
40	87	105	16	20	16	63	54	18.7	143.9	4	285	161853	CRZNG-40
50	99	117	16	24	16	75	64	23.6	153.8	4	473	161854	CRZNG-50
63	116	136	20	24	20	90	75	23.9	169.1	4	687	161855	CRZNG-63
80	136	156	20	28	20	110	93	31.4	187.6	4	1296	161856	CRZNG-80
100	164	189	25	38	25	132	110	30.3	206.5	4	2254	161857	CRZNG-100
125	192	217	25	50	25	160	131	40	250	4	3484	185362	CRZNG-125

1) Corrosion resistance class CRC 4 to Festo standard FN 940070

Particularly high corrosion stress. Outdoor exposure under extreme corrosive conditions. Parts exposed to aggressive media, e.g. in the chemical or food industries. Such applications may need to be safeguarded by special tests (→ also FN 940082), using appropriate media.

2) Suitable for ATEX

Trunnion supports CRLNZG

Material:
High-alloy steel
Free of copper and PTFE

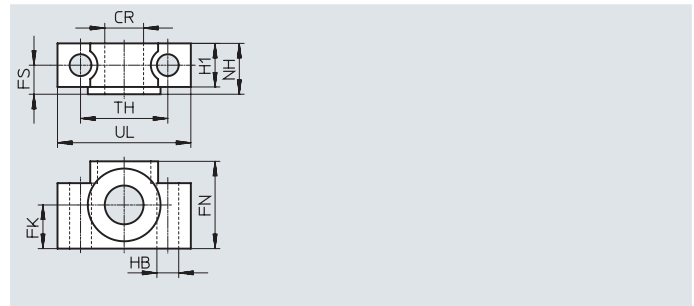
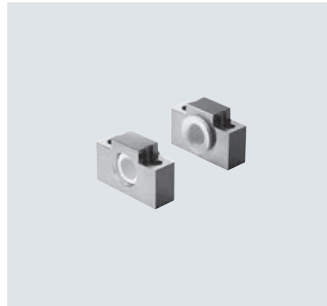

Dimensions and ordering data													
For \varnothing [mm]	CR \varnothing D11	FK \varnothing ± 0.1	FN	FS	H1	HB \varnothing H13	NH	TH ± 0.2	UL	CRC ¹⁾	Weight [g]	Part no.	Type
32	12	15	30	10.5	15	6.6	18	32	46	4	205	161874	CRLNZG-32
40, 50	16	18	36	12	18	9	21	36	55	4	323	161875	CRLNZG-40/50
63, 80	20	20	40	13	20	11	23	42	65	4	435	161876	CRLNZG-63/80
100, 125	25	25	50	16	24.5	14	28.5	50	75	4	739	161877	CRLNZG-100/125

1) Corrosion resistance class CRC 4 to Festo standard FN 940070

Particularly high corrosion stress. Outdoor exposure under extreme corrosive conditions. Parts exposed to aggressive media, e.g. in the chemical or food industries. Such applications may need to be safeguarded by special tests (→ also FN 940082), using appropriate media.

Accessories

Swivel flange SNCB-R3

Material:
Die-cast aluminium with protective coating
Free of copper and PTFE

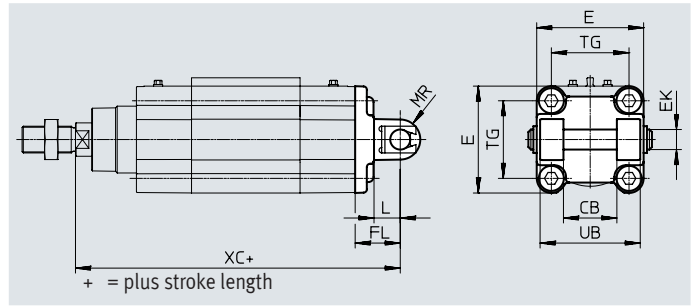
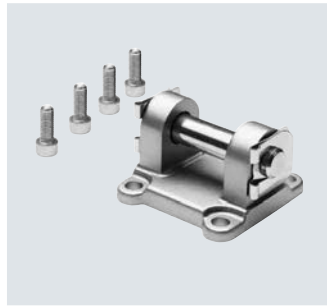

Dimensions and ordering data

For \varnothing [mm]	CB	E	EK \varnothing H9/e8	FL ± 0.2	L	MR -0.5	UB h14	TG	XC	CRC ¹⁾	Weight [g]	Part no.	Type
32	26	45 ^{+0.2/-0.5}	10	22	13	8.5	45	32.5	141.1	3	100	176944	SNCB-32-R3
40	28	54 ^{-0.5}	12	25	16	12	52	38	158.9	3	151	176945	SNCB-40-R3
50	32	64 ^{-0.6}	12	27	16	12	60	46.5	168.8	3	228	176946	SNCB-50-R3
63	40	75 ^{-0.6}	16	32	21	16	70	56.5	189.1	3	371	176947	SNCB-63-R3
80	50	93 ^{-0.8}	16	36	22	16	90	72	209.6	3	632	176948	SNCB-80-R3
100	60	110 ^{+0.3/-0.8}	20	41	27	20	110	89	228.5	3	986	176949	SNCB-100-R3
125	70	131 ^{-0.8}	25	50	30	25	130	110	275	3	1776	176950	SNCB-125-R3

1) Corrosion resistance class CRC 3 to Festo standard FN 940070

High corrosion stress. Outdoor exposure under moderate corrosive conditions. Externally visible parts with primarily functional surface requirements which are in direct contact with a normal industrial environment.

Accessories

Swivel flange

SNCS/CRSNCS/SNCS-...-R3

Material:

SNCS 32 ... 50:

Die-cast aluminium

SNCS 63 ... 125:

Wrought aluminium alloy

CRSNCS 32 ... 80:

High-alloy stainless steel

SNCS-...-R3 100 ... 125:

Wrought aluminium alloy with

protective coating

RoHS-compliant

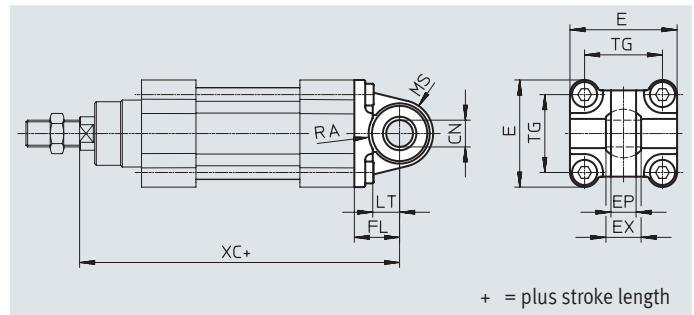
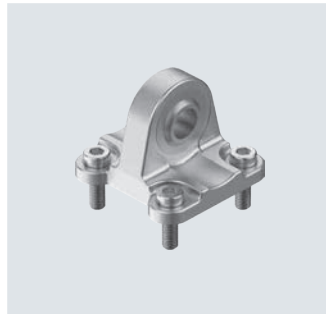

+ = plus stroke length

Dimensions and ordering data

For \varnothing [mm]	CN \varnothing		E		EP	EX	FL
	DSBF-C-...	DSBF-C-...-R3	DSBF-C-...	DSBF-C-...-R3	± 0.2		± 0.2
32	10 ^{+0.013}	10+0.015/-0.04	45+0.2/-0.5	45-0.5	10.5	14	22
40	12 ^{+0.015}	12+0.018/-0.04	54 _{-0.5}	54 _{-0.5}	12	16	25
50	16 ^{+0.015}	16+0.018/-0.04	64 _{-0.6}	64 _{-0.6}	15	21	27
63	16 ^{+0.015}	16+0.018/-0.04	74.5+0.5	75 _{-0.6}	15	21	32
80	20 ^{+0.018}	20+0.021/-0.04	92.2+0.8	93 _{-0.8}	18	25	36
100	20 ^{+0.018}	20+0.021/-0.04	109+1/-0.7	109+1/-0.7	18	25	41
125	30 ^{+0.018}	30+0.021/-0.04	132+1/-0.7	132+1/-0.7	25	37	50

For \varnothing [mm]	LT	MS		RA		TG	XC
		DSBF-C-...	DSBF-C-...-R3	DSBF-C-... +1	DSBF-C-...-R3 +1		
32	13	15 ^{+0.5}	15 ^{+0.5}	14.5	14.5	32.5	141.1
40	16	17 ^{+0.5}	17 ^{+0.5}	17.5	17.5	38	158.9
50	16	20 ^{+0.5}	20 ^{+0.5}	18.5	19	46.5	168.8
63	21	23 _{-0.5}	22 ^{+0.5}	23	23	56.5	189.1
80	22	28 _{-0.5}	27 ^{+0.5}	25	25	72	209.6
100	27	30 ± 0.5	30 ± 0.5	95	100	89	228.5
125	30	39 ± 0.5	39 ± 0.5	100	100	110	275

For \varnothing [mm]	Basic type				High corrosion protection			
	CRC ¹⁾	Weight [g]	Part no.	Type	CRC ¹⁾	Weight [g]	Part no.	Type
32	1	86	174397	SNCS-32	4	161	2895920	CRSNCS-32
40	1	122	174398	SNCS-40	4	239	2895921	CRSNCS-40
50	1	216	174399	SNCS-50	4	403	2895922	CRSNCS-50
63	2	281	174400	SNCS-63	4	576	2895923	CRSNCS-63
80	2	557	174401	SNCS-80	4	1173	2895924	CRSNCS-80
100	2	683	174402	SNCS-100	3	684	2895925	SNCS-100-R3
125	2	1369	174403	SNCS-125	3	1369	2895926	SNCS-125-R3

1) Corrosion resistance class CRC 1 to Festo standard FN 940070

Low corrosion stress. Dry internal application or transport and storage protection. Also applies to parts behind coverings, in the non-visible interior area, and parts which are covered in the application (e.g. drive trunnions).

Corrosion resistance class CRC 2 to Festo standard FN 940070

Moderate corrosion stress. Indoor applications in which condensation can occur. External visible parts with primarily decorative surface requirements which are in direct contact with a normal industrial environment.

Corrosion resistance class CRC 3 to Festo standard FN 940070

High corrosion stress. Outdoor exposure under moderate corrosive conditions. Externally visible parts with primarily functional surface requirements which are in direct contact with a normal industrial environment.

Corrosion resistance class CRC 4 to Festo standard FN 940070

Particularly high corrosion stress. Outdoor exposure under extreme corrosive conditions. Parts exposed to aggressive media, e.g. in the chemical or food industries. Such applications may need to be safeguarded by special tests

(→ also FN 940082), using appropriate media.

Accessories

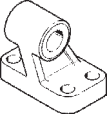
Ordering data – Mounting components, corrosion-resistant			
Designation	For \varnothing	Part no.	Type
Clevis foot CRLNG			
	32	161840	CRLNG-32
	40	161841	CRLNG-40
	50	161842	CRLNG-50
	63	161843	CRLNG-63
	80	161844	CRLNG-80
	100	161845	CRLNG-100
	125	176951	CRLNG-125

Ordering data – Mounting components, high corrosion protection				Data sheets → Internet: clevis foot
Designation	For diameter	Part no.	Type	
Clevis foot LBG-R3				
	32	2078790	LBG-32-R3	
	40	2078792	LBG-40-R3	
	50	2078794	LBG-50-R3	
	63	2078795	LBG-63-R3	
	80	2078797	LBG-80-R3	
	100	2078799	LBG-100-R3	
	125	2078837	LBG-125-R3	

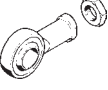
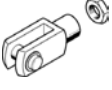
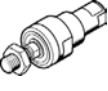
Ordering data – Piston rod attachments, corrosion-resistant				Data sheets → Internet: piston rod attachment					
		For diameter	Part no.	Type			For diameter	Part no.	Type
Rod eye CRSGS				Rod clevis CRSG¹⁾					
	32	195582	CRSGS-M10x1.25		32	13569	CRSG-M10x1.25		
	40	195583	CRSGS-M12x1.25		40	13570	CRSG-M12x1.25		
	50, 63	195584	CRSGS-M16x1.5		50, 63	13571	CRSG-M16x1.5		
	80, 100	195585	CRSGS-M20x1.5		80, 100	13572	CRSG-M20x1.5		
	125	195586	CRSGS-M27x2		125	185361	CRSG-M27x2		
Self-aligning rod coupler CRFK¹⁾									
	32	2305778	CRFK-M10x1.25						
	40	2305779	CRFK-M12x1.25						
	50, 63	2490673	CRFK-M16x1.5						
	80, 100	2545677	CRFK-M20x1.5						

1) Suitable for ATEX

Accessories

Bellows kit DADB



General technical data

Type DADB-V6-	32	40	50	63	80	100
Max. stroke range of the cylinder ¹⁾	[mm]	10 ... 500	10 ... 500	10 ... 500	10 ... 500	10 ... 500
Type of mounting	Via threaded pin					
Mounting position	Any					
Media resistance	Dust, chippings, oil, grease, fuel (→ Internet: media resistance)					
Ambient temperature ²⁾	[°C]	-10 ... +80				
Degree of protection	IP54					
Corrosion resistance CRC ³⁾	3					

1) In combination with the bellows kit DADB

2) Note operating range of proximity switches and cylinder

3) Corrosion resistance class CRC 3 to Festo standard FN 940070

High corrosion stress. Outdoor exposure under moderate corrosive conditions. Externally visible parts with primarily functional surface requirements which are in direct contact with a normal industrial environment.

Materials

Sectional view

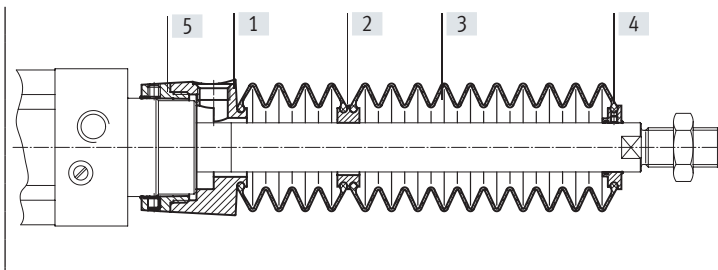

Bellows

[1]	Connection	Polyamide
[2]	Adapter	Polyamide
[3]	Bellows	NBR
[4]	End piece	Polyamide
[5]	Connector	Polyamide
-	O-ring	NBR
Note on materials		Free of copper and PTFE RoHS-compliant

Weight [g]

Type DADB-V6- Stroke [mm]	32	40	50	63	80	100
10 ... 50	29	42	71	69	99	124
51 ... 125	41	56	91	89	127	152
126 ... 175	52	68	105	103	140	165
176 ... 250	66	85	129	127	193	218
251 ... 300	79	100	147	145	231	255
301 ... 350	92	115	166	164	268	293
351 ... 375	92	115	167	165	259	284
376 ... 425	104	129	185	183	296	321
426 ... 475	117	144	204	202	334	359
476 ... 500	117	144	205	203	324	349

Accessories

Travel speed v as a function of tubing length l

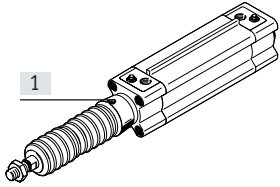

The bellows kit is a leak-free system. To prevent unwanted media from being drawn in, the supply and exhaust air for the kit must be ducted via a pressure

compensation hole in the connection part [1]. The pressure generated in the bellows kit by the positioning motion is primarily defined by the travel speed and tubing length.

The recommended tubing length based on the travel speed of the drive can be read from the graph.

Advancing

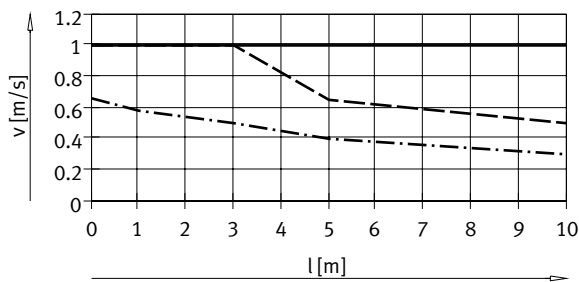

— Diameter 32/ 50/63
 Diameter 40
 - - - Diameter 80/100

Retracting

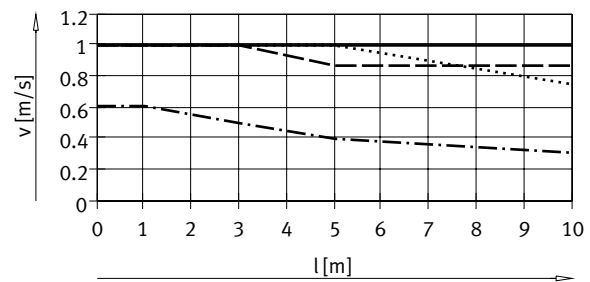

— Diameter 32
 Diameter 40
 - - - Diameter 50/63
 - · - · - Diameter 80/100

Note
 The push-in fittings in the adjacent table must be used for the pressure compensation hole. Silencers can be used as an alternative. This reduces the travel speed slightly.

Tube size and push-in fitting for pressure compensation hole

∅ [mm]	Tubing O.D. [mm]	Push-in fitting	
		Part no.	Type
32, 40	8	186109	QS-G1/8-8-I
		578376	NPQH-DK-G18-Q8-P10
		578362	NPQH-D-G18-S8-P10
50, 63, 80, 100	12	186350	QS-G1/4-12
		578344	NPQH-D-G14-Q12-P10
		578366	NPQH-D-G14-S12-P10

Accessories

Dimensions

Download CAD data → www.festo.com

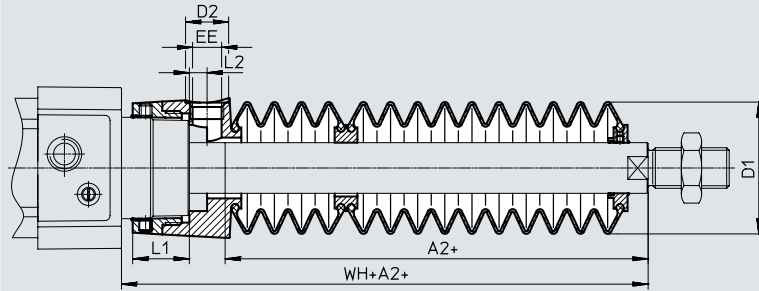

+ = plus stroke length

∅ Stroke [mm]	32							40						
	A2 ¹⁾	D1 max.	D2	EE	L1	L2	WH+A2	A2 ¹⁾	D1 max.	D2	EE	L1	L2	WH+A2
10 ... 50	29	38	14	G1/8	12.9	5.4	55	28	46	14	G1/8	16.3	5.4	56.7
51 ... 125	47						73	43						71.7
126 ... 175	61						87	56						84.7
176 ... 250	80						106	72						100.7
251 ... 300	96						122	86						114.7
301 ... 350	112						138	100						128.7
351 ... 375	114						140	101						129.7
376 ... 425	130						156	115						143.7
426 ... 475	145						171	130						158.7
476 ... 500	147	173	131	159.7										

∅ Stroke [mm]	50							63						
	A2 ¹⁾	D1 max.	D2	EE	L1	L2	WH+A2	A2 ¹⁾	D1 max.	D2	EE	L1	L2	WH+A2
10 ... 50	28	57	17	G1/4	22.35	7	63.6	28	57	17	G1/4	22.4	7	63.9
51 ... 125	46						81.6	46						81.9
126 ... 175	56						91.6	56						91.9
176 ... 250	73						108.6	73						108.9
251 ... 300	86						121.6	86						121.9
301 ... 350	97						132.6	97						132.9
351 ... 375	105						140.6	105						140.9
376 ... 425	116						151.6	116						151.9
426 ... 475	126						161.6	126						161.9
476 ... 500	134	169.6	134	169.9										

∅ Stroke [mm]	80							100						
	A2 ¹⁾	D1 max.	D2	EE	L1	L2	WH+A2	A2 ¹⁾	D1 max.	D2	EE	L1	L2	WH+A2
10 ... 50	25	93	17	G1/4	28	4	70.4	25	93	17	G1/4	28	4	74.3
51 ... 125	37						82.4	37						86.3
126 ... 175	49						94.4	49						98.3
176 ... 250	62						107.4	62						111.3
251 ... 300	74						119.4	74						123.3
301 ... 350	86						131.4	86						135.3
351 ... 375	87						132.4	87						136.3
376 ... 425	98						143.4	98						147.3
426 ... 475	110						155.4	110						159.3
476 ... 500	111	156.4	111	160.3										

1) The dimension corresponds to the E value (extended piston rod) of the drive

Accessories

Ordering data – Bellows kit

An extended piston rod (order code ...E) → page 19 is absolutely essential if a bellows kit is to be used.

The following table specifies the required dimension for E as a function of piston diameter and stroke of the cylinder as well as the associated bellows kit:

Order example:

Selected standards-based cylinder:

DSBF-C-32-320-PPV-A-N3-...E-R

The dimension for the corresponding E value (see table):

112 mm

Complete order reference for standards-based cylinder:

DSBF-C-32-320-PPV-A-N3-112E-R

The corresponding bellows kit:

DADB-V6-32-S301-350

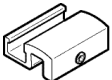

Cylinder data			Bellows kit		Cylinder data			Bellows kit	
∅	Stroke	Dimension for E	Part no.	Type	∅	Stroke	Dimension for E	Part no.	Type
[mm]	[mm]	[mm]			[mm]	[mm]	[mm]		
32	10 ... 50	29	553271	DADB-V6-32-S10-50	40	10 ... 50	28	553291	DADB-V6-40-S10-50
	51 ... 125	47	553273	DADB-V6-32-S51-125		51 ... 125	43	553293	DADB-V6-40-S51-125
	126 ... 175	61	553275	DADB-V6-32-S126-175		126 ... 175	56	553295	DADB-V6-40-S126-175
	176 ... 250	80	553277	DADB-V6-32-S176-250		176 ... 250	72	553297	DADB-V6-40-S176-250
	251 ... 300	96	553279	DADB-V6-32-S251-300		251 ... 300	86	553299	DADB-V6-40-S251-300
	301 ... 350	112	553281	DADB-V6-32-S301-350		301 ... 350	100	553301	DADB-V6-40-S301-350
	351 ... 375	114	553283	DADB-V6-32-S351-375		351 ... 375	101	553303	DADB-V6-40-S351-375
	376 ... 425	130	553285	DADB-V6-32-S376-425		376 ... 425	115	553305	DADB-V6-40-S376-425
	426 ... 475	145	553287	DADB-V6-32-S426-475		426 ... 475	130	553307	DADB-V6-40-S426-475
476 ... 500	147	553289	DADB-V6-32-S476-500	476 ... 500	131	553309	DADB-V6-40-S476-500		
50	10 ... 50	28	553311	DADB-V6-50-S10-50	63	10 ... 50	28	553331	DADB-V6-63-S10-50
	51 ... 125	46	553313	DADB-V6-50-S51-125		51 ... 125	46	553333	DADB-V6-63-S51-125
	126 ... 175	56	553315	DADB-V6-50-S126-175		126 ... 175	56	553335	DADB-V6-63-S126-175
	176 ... 250	73	553317	DADB-V6-50-S176-250		176 ... 250	73	553337	DADB-V6-63-S176-250
	251 ... 300	86	553319	DADB-V6-50-S251-300		251 ... 300	86	553339	DADB-V6-63-S251-300
	301 ... 350	97	553321	DADB-V6-50-S301-350		301 ... 350	97	553341	DADB-V6-63-S301-350
	351 ... 375	105	553323	DADB-V6-50-S351-375		351 ... 375	105	553343	DADB-V6-63-S351-375
	376 ... 425	116	553325	DADB-V6-50-S376-425		376 ... 425	116	553345	DADB-V6-63-S376-425
	426 ... 475	126	553327	DADB-V6-50-S426-475		426 ... 475	126	553347	DADB-V6-63-S426-475
476 ... 500	134	553329	DADB-V6-50-S476-500	476 ... 500	134	553349	DADB-V6-63-S476-500		
80	10 ... 50	25	553351	DADB-V6-80-S10-50	100	10 ... 50	25	553371	DADB-V6-100-S10-50
	51 ... 125	37	553353	DADB-V6-80-S51-125		51 ... 125	37	553373	DADB-V6-100-S51-125
	126 ... 175	49	553355	DADB-V6-80-S126-175		126 ... 175	49	553375	DADB-V6-100-S126-175
	176 ... 250	62	553357	DADB-V6-80-S176-250		176 ... 250	62	553377	DADB-V6-100-S176-250
	251 ... 300	74	553359	DADB-V6-80-S251-300		251 ... 300	74	553379	DADB-V6-100-S251-300
	301 ... 350	86	553361	DADB-V6-80-S301-350		301 ... 350	86	553381	DADB-V6-100-S301-350
	351 ... 375	87	553363	DADB-V6-80-S351-375		351 ... 375	87	553383	DADB-V6-100-S351-375
	376 ... 425	98	553365	DADB-V6-80-S376-425		376 ... 425	98	553385	DADB-V6-100-S376-425
	426 ... 475	110	553367	DADB-V6-80-S426-475		426 ... 475	110	553387	DADB-V6-100-S426-475
476 ... 500	111	553369	DADB-V6-80-S476-500	476 ... 500	111	553389	DADB-V6-100-S476-500		

Accessories

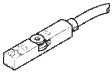

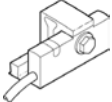



Ordering data – Mounting kit					
	Description	Part no.	Type		
	For mounting the proximity switch CRSMT-8M on the mounting rail	1806790	SMB-8-C		

Ordering data – Proximity switches for T-slot, magneto-resistive						Data sheets →	Internet: smt
	Type of mounting	Switching output	Electrical connection	Cable length [m]	Part no.	Type	
N/O contact							
	Insertable in the slot from above, flush with the mounting kit	PNP	Cable, 3-wire	5.0	574380	CRSMT-8M-PS-24V-K-5.0-OE	
			Cable, 3-wire	10.0	574381	CRSMT-8M-PS-24V-K-10.0-OE	
			Plug M8x1, 3-pin	0.3	574383	CRSMT-8M-PS-24V-K-0.3-M8D	
			Plug M12x1, 3-pin	0.3	574382	CRSMT-8M-PS-24V-K-0.3-M12	

Ordering data – Proximity switches for T-slot, magneto-resistive						Data sheets →	Internet: smt
	Type of mounting	Switching output	Electrical connection	Cable length [m]	Part no.	Type	
N/O contact							
	Is mounted on the mounting rail	PNP	Cable, 3-wire	5.0	571339	SMT-C1-PS-24V-K-5.0-OE	
			Plug M8x1, 3-pin	0.3	571342	SMT-C1-PS-24V-K-0.3-M8D	
			Plug M12x1, 3-pin	0.3	571341	SMT-C1-PS-24V-K-0.3-M12	

Ordering data – Connecting cables						Data sheets →	Internet: nebu
	Electrical connection, left	Electrical connection, right	Cable length [m]	Part no.	Type		
	Straight socket, M8x1, 3-pin	Cable, open end, 3-wire	2.5	541333	NEBU-M8G3-K-2.5-LE3		
			5	541334	NEBU-M8G3-K-5-LE3		
	Straight socket, M12x1, 5-pin	Cable, open end, 3-wire	2.5	541363	NEBU-M12G5-K-2.5-LE3		
5			541364	NEBU-M12G5-K-5-LE3			
	Angled socket, M8x1, 3-pin	Cable, open end, 3-wire	2.5	541338	NEBU-M8W3-K-2.5-LE3		
			5	541341	NEBU-M8W3-K-5-LE3		
	Angled socket, M12x1, 5-pin	Cable, open end, 3-wire	2.5	541367	NEBU-M12W5-K-2.5-LE3		
5			541370	NEBU-M12W5-K-5-LE3			

Accessories

Ordering data – Push-in fittings			Material	Weight [g]	Part no.	Type	Data sheets → Internet: qs			
Connection		PU ¹⁾								
Thread	Tubing O.D.									
With external hex										
	G1/8	6	High-alloy stainless steel	14.1	1366257	NPCK-C-D-G18-K6	1			
		8		13.4	1490383	NPCK-C-D-G18-K8				
	G1/4	8		28.85	1691701	NPCK-C-D-G14-K8				
		10		32.9	1489336	NPCK-C-D-G14-K10				
	G3/8	10		51.15	1489614	NPCK-C-D-G38-K10				
	G1/8	4	Brass, nickel-plated, with sealing ring	6.3	578338	NPQH-D-G18-Q4-P10	10			
		6		9.2	578339	NPQH-D-G18-Q6-P10				
		8		11.9	578340	NPQH-D-G18-Q8-P10				
	G1/4	6		13.1	578341	NPQH-D-G14-Q6-P10				
		8		14.1	578342	NPQH-D-G14-Q8-P10				
		10		17.5	578343	NPQH-D-G14-Q10-P10				
	G3/8	8		20.6	578345	NPQH-D-G38-Q8-P10				
		10		22.7	578346	NPQH-D-G38-Q10-P10				
	G1/2	10		35.4	578349	NPQH-D-G12-Q10		1		
		12		37.1	578350	NPQH-D-G12-Q12				
		R1/8		6	Stainless steel, with PTFE coating	9.9		162862	CRQS-1/8-6	1
				8		12		162863	CRQS-1/8-8	
R1/4		8	18	162864		CRQS-1/4-8				
		10	22	162865		CRQS-1/4-10				
R3/8		10	29	162866		CRQS-3/8-10				
		12	37	162867		CRQS-3/8-12				
R1/2		12	55	162868		CRQS-1/2-12				
		16	59	162869		CRQS-1/2-16				
With internal hex										
	G1/8	4	Brass, nickel-plated, with sealing ring	6.2	578374	NPQH-DK-G18-Q4-P10	10			
		6		9.1	578375	NPQH-DK-G18-Q6-P10				
		8		12.8	578376	NPQH-DK-G18-Q8-P10				
	G1/4	8		14.4	578377	NPQH-DK-G14-Q8-P10				
		10		18.6	578378	NPQH-DK-G14-Q10-P10				
	G3/8	12		28.2	578379	NPQH-DK-G38-Q12-P10				
With external hex										
	G1/8	4	Brass, nickel-plated, with sealing ring	16.3	578280	NPQH-L-G18-Q4-P10	10			
		6		19.3	578281	NPQH-L-G18-Q6-P10				
		8		22.2	578282	NPQH-L-G18-Q8-P10				
	G1/4	6		22.4	578283	NPQH-L-G14-Q6-P10				
		8		25.8	578284	NPQH-L-G14-Q8-P10				
		10		33.1	578285	NPQH-L-G14-Q10-P10				
	G3/8	8		36.7	578287	NPQH-L-G38-Q8-P10				
		10		38.2	578288	NPQH-L-G38-Q10-P10				
	G1/2	10		42.6	578291	NPQH-L-G12-Q10		1		
		12		66.3	578292	NPQH-L-G12-Q12				
		R1/8		6	Stainless steel, with PTFE coating	19		162872	CRQSL-1/8-6	1
				8		26		162873	CRQSL-1/8-8	
R1/4		8	30	162874		CRQSL-1/4-8				
		10	42	162875		CRQSL-1/4-10				
R3/8		10	49	162876		CRQSL-3/8-10				
		12	65	162877		CRQSL-3/8-12				
R1/2		12	85	162878		CRQSL-1/2-12				
		16	99	162879		CRQSL-1/2-16				

1) Packaging unit

Accessories

Ordering data – Plastic tubing, standard O.D.		Type	Data sheets → Internet: tubing
	Good resistance to chemicals and hydrolysis	PLN	
	Pneumatic tubing with resistance to high temperatures and chemicals	PFAN	
	Approved for use in the food area and resistant to hydrolysis	PUN-H	

Ordering data – One-way flow control valves				Part no.	Type	Data sheets → Internet: crgla
Connection Thread	For push-in fitting	Material	Weight [g]			
	G1/8	CRQS/CRQSL/CRQST, QS	Electropolished stainless steel casting	37.8	161404	CRGRLA-1/8-B
	G1/4			71.6	161405	CRGRLA-1/4-B
	G3/8			126.9	161406	CRGRLA-3/8-B
	G1/2			262.3	161407	CRGRLA-1/2-B

Ordering data – Plug screws, corrosion-resistant							
	For diameter	Material	CRC ¹⁾	Weight [g]	Part no.	Type ³⁾	PU ²⁾
	32, 40	High-alloy steel	3	6.5	1355016	DAMD-PS-M6-12-R1	4
	50, 63		3	14	650121	DAMD-PS-M8-16-R1	
	80, 100		3	23	1355026	DAMD-PS-M10-16-R1	

1) Corrosion resistance class CRC 3 to Festo standard FN 940070

High corrosion stress. Outdoor exposure under moderate corrosive conditions. Externally visible parts with primarily functional surface requirements which are in direct contact with a normal industrial environment.

2) Packaging unit

3) Suitable for ATEX

Festo - Your Partner in Automation



1 Festo Inc.
5300 Explorer Drive
Mississauga, ON L4W 5G4
Canada

Festo Customer Interaction Center
Tel: 1 877 463 3786
Fax: 1 877 393 3786
Email: customer.service.ca@festo.com

2 Festo Pneumatic
Av. Ceylán 3,
Col. Tequesquináhuac
54020 Tlalneantla,
Estado de México

Multinational Contact Center
01 800 337 8669
ventas.mexico@festo.com

3 Festo Corporation
1377 Motor Parkway
Suite 310
Islandia, NY 11749

Festo Customer Interaction Center
1 800 993 3786
1 800 963 3786
customer.service.us@festo.com

4 Regional Service Center
7777 Columbia Road
Mason, OH 45040

Connect with us



www.festo.com/socialmedia



www.festo.com

Subject to change