

## Guided drives DGRF-C, clean design

**FESTO**

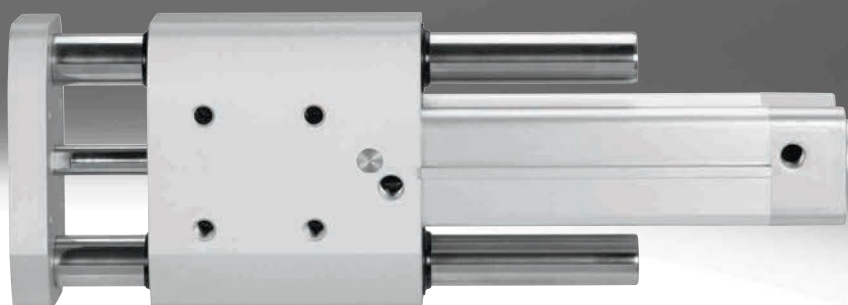

## Key features and product range overview

### At a glance

- The guided drive is used wherever hygiene, ease of cleaning and resistance are important, predominantly in dry and splash zones in the food and packaging industry.
- Corrosion-resistant in harsh environmental conditions
- Easy-to-clean design
- NSF H1-compliant lubrication
- Resistant to conventional cleaning agents
- For hygiene reasons, the threads on the end caps should be sealed with suitable plug screws
- With a dry-running seal (A3), the drive will continue to function reliably even if the lubricant has been washed away due to frequent cleaning.

### Areas of application:

- Bottling systems in the beverage industry
  - Labelling and palletising machines
- Milk processing
  - Filling ice cream and yoghurt containers, etc.
- Meat processing
- Confectionery production
- Production of baked goods
- Packaging industry
  - Food, pharmaceuticals, cosmetics, chemicals, beverages and tobacco

### Mounting options

#### From underneath

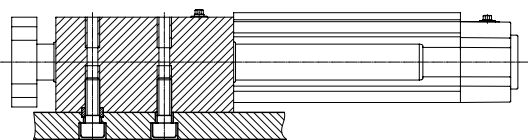

#### From above

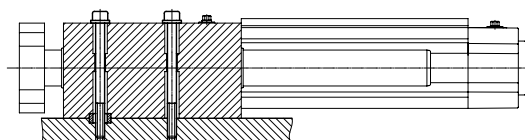

#### On the yoke plate

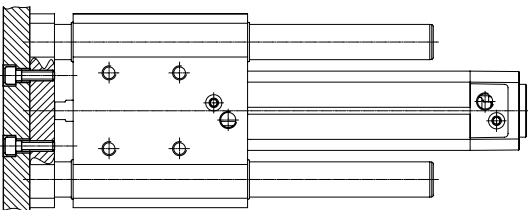

### Product range overview

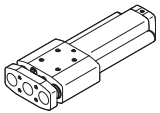
Function	Type	Piston diameter	Stroke	Cushioning			Position sensing A	Mounting rail R	Unlubricated operation A3
				P	PPV	PPS			
Double-acting		20, 25	10 ... 400	■	–	–	–	–	■
		32	10 ... 400	■	■	■	■	■	■
		40, 50, 63	10 ... 400	–	■	■	■	■	■

## Peripherals overview

Piston diameter 20, 25

Piston diameter 32, 40, 50, 63

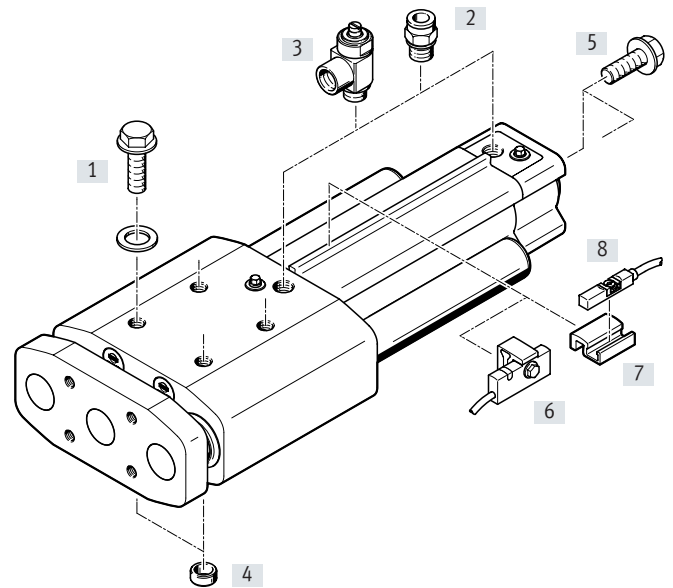
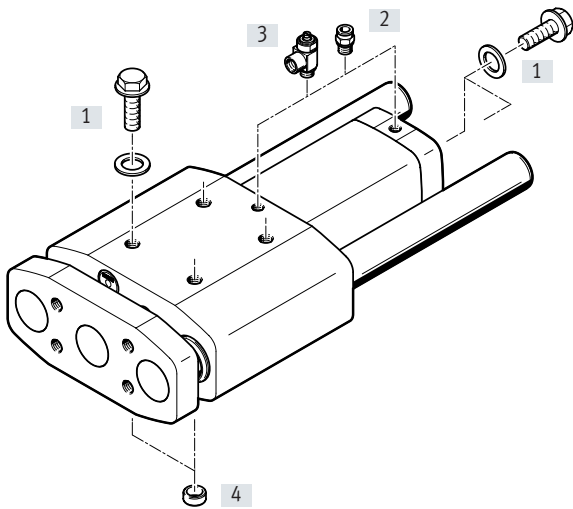

Accessories		Description	DGRF...-			→ Page/ Internet
			P	PPV	PPS	
[1]	Plug screw DAMD	<ul style="list-style-type: none"> <li>For sealing unused mounting threads</li> <li>Screws are not included in the scope of delivery of the drive</li> <li>Cover plate is included in scope of delivery of the screw</li> </ul>	■	■	■	15
[2]	Push-in fitting NPQH/CRQS/CRQSL/NPQP	<ul style="list-style-type: none"> <li>For connecting compressed air tubing with standard O.D.</li> </ul>	■	■	■	13
[3]	One-way flow control valve CRGRLA/VFOH	<ul style="list-style-type: none"> <li>For regulating speed</li> </ul>	■	■	■	14
[4]	Centring sleeve ZBH	<ul style="list-style-type: none"> <li>For centring the guided drive</li> <li>Two centring sleeves included in the scope of delivery</li> </ul>	■	■	■	15
[5]	Plug screw DAMD	<ul style="list-style-type: none"> <li>For sealing unused mounting threads</li> <li>Screws are not included in the scope of delivery of the drive</li> </ul>	■	■	■	15
[6]	Proximity sensor SMT-C1	<ul style="list-style-type: none"> <li>For sensing the piston rod position</li> <li>Proximity sensor is fitted on the sensor mounting rail</li> </ul>	■	■	■	12
[7]	Mounting kit SMB-8-C	<ul style="list-style-type: none"> <li>For fitting the proximity sensor CRSMT-8M</li> <li>Mounting kit is fitted on the sensor mounting rail</li> </ul>	–	■ <sup>1)</sup>	■	12
[8]	Proximity sensor CRSMT-8M	<ul style="list-style-type: none"> <li>For sensing the piston rod position</li> </ul>	–	■ <sup>1)</sup>	■	12

1) Possible when ordering drives from 02/2014 (series E2).

## Type codes

001	Series	
DGRF	Guided drive, double-acting, clean design	

002	Product version	
C	Easy-to-clean design	

003	Guide	
GF	Plain bearing	

004	Piston diameter	
20	20	
25	25	
32	32	
40	40	
50	50	
63	63	

005	Stroke	
...	10 ... 400	

006	Cushioning	
P	Elastic cushioning rings/plates on both sides	
PPS	Pneumatic cushioning, self-adjusting at both ends	
PPV	Pneumatic cushioning, adjustable at both ends	

007	Position sensing	
	None	
A	For proximity sensor	

008	Sensor mounting, external	
	None	
R	Mounting rail for sensors	

009	Scraper variant	
	None	
A3	For unlubricated operation	

## Data sheet

## P cushioning

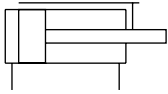

 Diameter  
 20 ... 63 mm

 Stroke length  
 10 ... 400 mm

## PPV cushioning

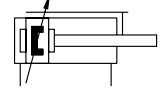

 [www.festo.com](http://www.festo.com)

## PPS cushioning

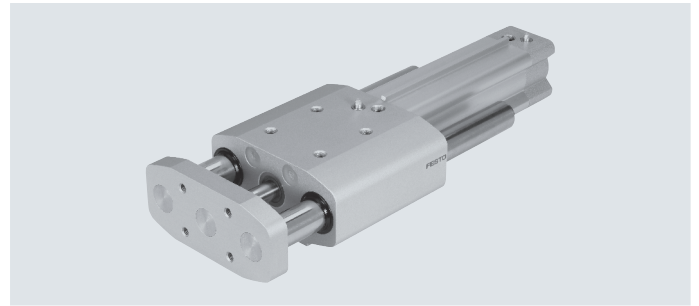
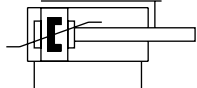

General technical data		20	25	32	40	50	63	
Piston diameter		20	25	32	40	50	63	
Pneumatic connection		M5	M5	G1/8	G1/4	G1/4	G3/8	
Mode of operation		Double-acting						
Design		Guide						
		Guide rods with yoke						
Guide		Plain-bearing guide						
Cushioning	P	Elastic cushioning rings at both ends			-			
	PPV	-			Pneumatic cushioning, adjustable at both ends			
	PPS	-			Pneumatic cushioning, self-adjusting at both ends			
Cushioning length	[mm]	-		20	20	22	22	
Position sensing		-			Via proximity sensor			
Type of mounting		With through-hole						
		Via female thread						
Mounting position		Any						
Torsional backlash <sup>1)</sup>	[°]	0.13	0.11	0.10	0.09	0.07	0.06	

1) Retracted state, without load

Operating and environmental conditions		20	25	32	40	50	63
Piston diameter		20	25	32	40	50	63
Variant				P	PPV/PPS		
Operating medium		Compressed air to ISO 8573-1:2010 [7:4:4]					
Note on the operating/pilot medium		Lubricated operation possible (in which case lubricated operation will always be required)					
Operating pressure	[MPa]	0.25 ... 1		0.2 ... 1	0.2 ... 1.2	0.2 ... 1.2	0.15 ... 1.2
	A3 [MPa]	0.2 ... 1			0.2 ... 1.2	0.15 ... 1.2	
Operating pressure	[bar]	2.5 ... 10		2 ... 10	2 ... 12	2 ... 12	1.5 ... 12
	A3 [bar]	2 ... 10			2 ... 12	1.5 ... 12	
Ambient temperature	[°C]	-20 ... +80					
Food-safe <sup>1)</sup>		→ Supplementary information on materials					
Corrosion resistance class CRC <sup>2)</sup>		3					

1) Additional information is available at [www.festo.com/sp](http://www.festo.com/sp) → Certificates.

2) Corrosion resistance class CRC 3 to Festo standard FN 940070

High corrosion stress. Outdoor exposure under moderate corrosive conditions. Externally visible parts with primarily functional surface requirements which are in direct contact with a normal industrial environment.

## Data sheet

Forces [N] and impact energy [J]						
Piston diameter	20	25	32	40	50	63
Theoretical force at 0.6 MPa (6 bar), advancing	189	295	483	754	1178	1870
Theoretical force at 0.6 MPa (6 bar), retracting	141	247	415	633	990	1682
Max. impact energy in the end positions with P cushioning	0.2	0.3	0.4	–	–	–

Permissible impact velocity:  $v_{perm.}$  Permissible impact velocity  
 $E$  Max. impact energy  
 $m_1$  Moving mass (drive)  
 $m_2$  Moving payload

Maximum permissible mass:

$$m_2 = \frac{2 \cdot E}{v^2} - m_1$$

 **Note**  
 These specifications represent the maximum values that can be achieved. The maximum permissible impact energy must be observed.

Weight [g]							
Piston diameter Variant	20	25	32		40	50	63
			P	PPV/PPS			
Product weight with 0 mm stroke	885	1199	2090	2305	3000	4800	6405
Additional weight per 10 mm stroke	52	55	80	78	90	140	143
Moving mass with 0 mm stroke	417	486	902	904	1065	1792	2114
Moving mass per 10 mm stroke	38	38	58	58	65	102	102

### Materials

#### Sectional view

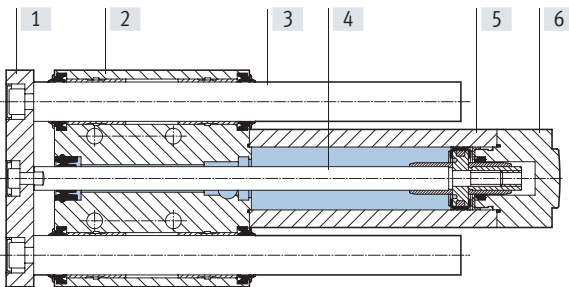

Guided drive	
[1] Yoke plate	Anodised wrought aluminium alloy
[2] Housing	Anodised wrought aluminium alloy
[3] Guide rod	High-alloy stainless steel
[4] Piston rod	High-alloy stainless steel
[5] Cylinder barrel	Anodised wrought aluminium alloy
[6] Cover	
DGRF...-20/-25/-32-P	Anodised wrought aluminium alloy
DGRF...-32-PPV/-PPS	Coated die-cast aluminium
DGRF...-40/-50/-63	Coated die-cast aluminium
– Seal	
DGRF...	TPE-U (PUR) media seal (modified for resistance to hydrolysis and cleaning)
DGRF...-A3	PE
PWIS conformity	VDMA24364-B2-L
Note on materials	RoHS-compliant

## Data sheet

### Max. effective load F as a function of stroke l

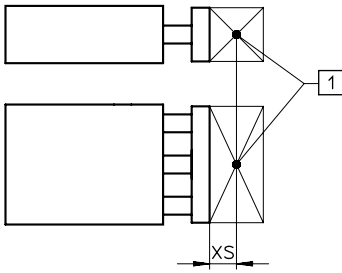

- Load data is based on a distance from the centre of gravity of  $X_S = 50\text{ mm}$
  - Load data can be requested for larger distances
- [1] Centre of gravity of payload

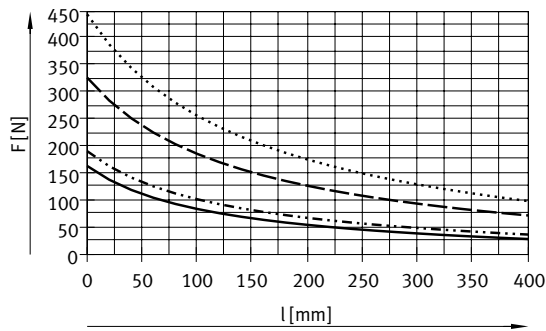

- ø 20
- ø 25
- - - ø 32/40
- · - · ø 50/63

### Max. torque load M as a function of stroke l

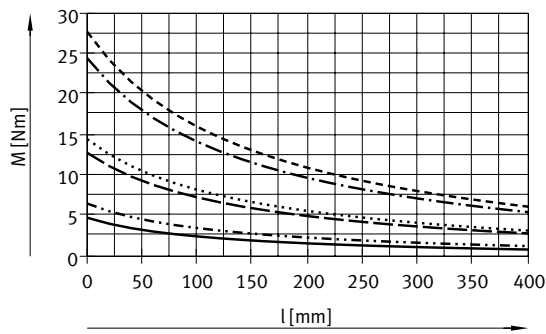
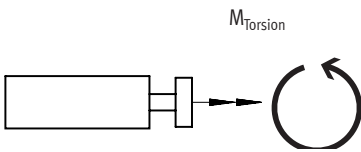

- ø 20
- ø 25
- - - ø 32
- · - · ø 40
- - - - ø 50
- - - - ø 63

## Data sheet

### Deflection of the piston rod

Deflection  $f_1$  due to bearing clearance as a function of stroke  $l$

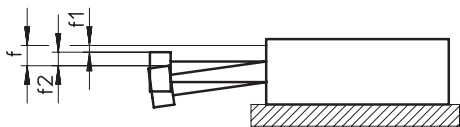

$$f = f_1 + f_2$$

$f$  = Total deflection of the piston rod

$f_1$  = Deflection due to bearing clearance

$f_2$  = Deflection due to transverse load

Deflection  $f_1$ ,  
due to bearing clearance as a function of stroke  $l$

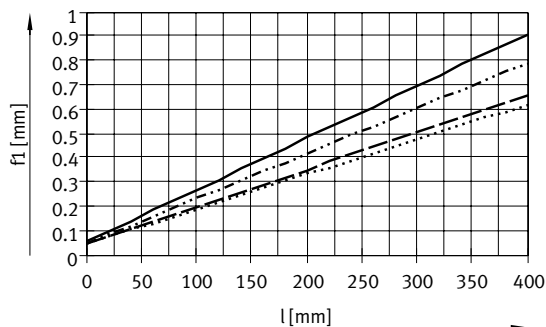

- $\varnothing 20$
- .....  $\varnothing 25$
- - -  $\varnothing 32/40$
- · - ·  $\varnothing 50/63$

Deflection  $f_2$ ,  
due to payload  $F$  and rigidity  $c$  as a function of stroke  $l$

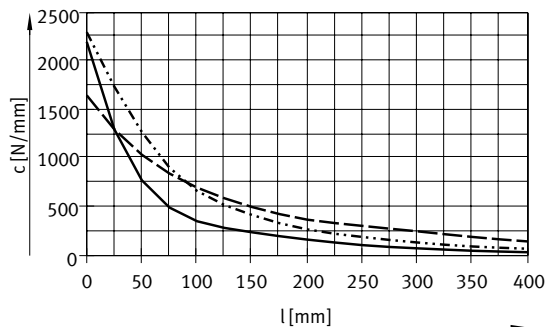

- $\varnothing 20/25$
- .....  $\varnothing 32/40$
- - -  $\varnothing 50/63$
- · - ·  $\varnothing 20/25$

### End-position sensing

With proximity sensor SMT-C1

A minimum stroke is required to be able to sense both end positions at the cylinder.

- [1] Position of the proximity sensor within the housing.

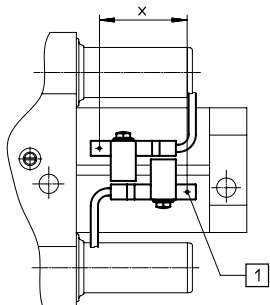

Piston diameter	32	40	50	63
Minimum stroke x [mm]	35	35	35	30

With mounting kit SMB-8-C and proximity sensor CRSMT-8M

A minimum stroke is required to be able to sense both end positions at the cylinder.

- [1] Position of the proximity sensor within the housing.

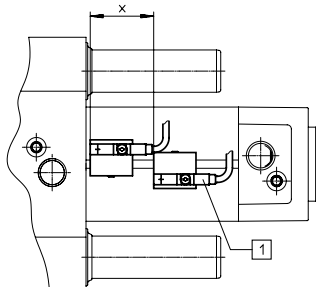

Piston diameter	32	40	50	63
Minimum stroke x [mm]	30	30	30	30



# Data sheet

## Dimensions

Download CAD data → [www.festo.com](http://www.festo.com)

DGRF...-P – Elastic cushioning rings at both ends

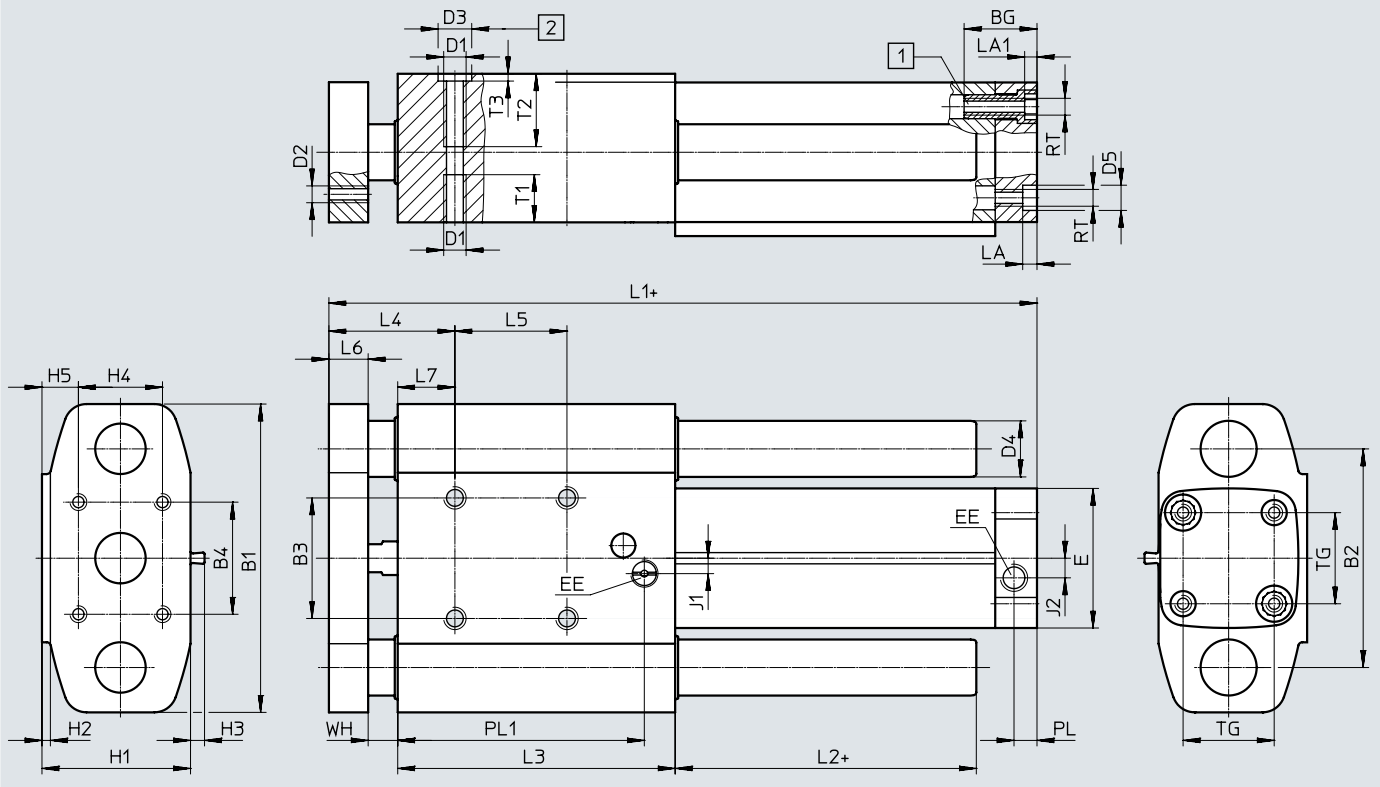

+ = plus stroke length

[1] Socket head screw with female thread

[2] Centring holes for centring sleeve ZBH

∅	BG	B1	B2	B3 <sup>2)</sup>	B4	D1	D2	D3 <sup>3)</sup>	D4	D5	E	EE
[mm]								∅ H7	∅	∅ F9		
20	19.5	83	58	30	30	M6	M5	9	16	9	37	M5
25	19.5	95	68	35	40	M6	M6	9	16	9	42	M5
32	26	110	78	43	40	M8	M6	12	20	9	50	G1/8

∅	H1	H2	H3 <sup>1)</sup>	H4	H5	J1	J2	L1	L2	L3	L4	L5
[mm]												
20	39	2	-	20	10.5	0	0	115 +1.4/-0.8	7	68	40 +1/-0.9	30
25	44	2	-	20	13	0	0	126 +1.4/-0.8	7	77	40 +1/-0.9	40
32	53	3	5	30	13	5.5	7	152.8 ±1.1	7.4	99	45 +0.9/-1	40

∅	L6	L7	LA	LA1	PL	PL1	RT	T1	T2	T3	TG	WH
[mm]												
20	12	18	4.9	4.6	6	62	M5	13	20	2.1	22	10 +0.5/-0.7
25	12	18	4.9	4.6	6	71	M5	13	25	2.1	26	10 +0.5/-0.7
32	14	20.4	5.1	4.6	8.2	88	M6	17	26	2.6	32.5	10.7 +0.3/-0.9

1) Only in combination with sensor mounting rail (DGRF-32...-R)

2) Tolerance between the centring holes ±0.02 mm

3) Two centring sleeves included in the scope of delivery

Data sheet

Dimensions

Download CAD data → [www.festo.com](http://www.festo.com)

DGRF-...-PPV – Pneumatic cushioning, adjustable at both ends,

DGRF-...-PPS – Pneumatic cushioning, self-adjusting at both ends

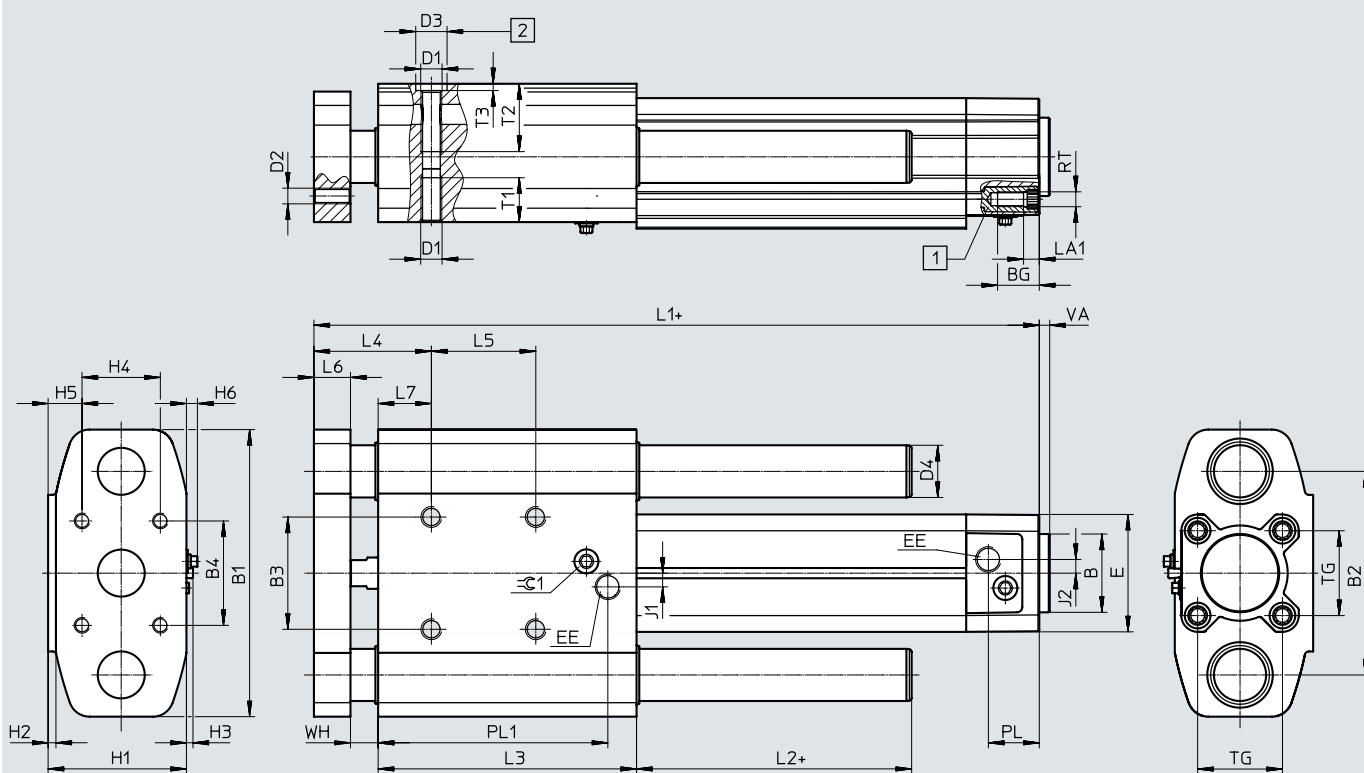

+ = plus stroke length

[1] Socket head screw with female thread

[2] Centring holes for centring sleeve ZBH

∅	B ∅ d11	BG	B1	B2	B3 <sup>2)</sup>	B4	D1	D2	D3 <sup>3)</sup> ∅ H7	D4 ∅	E	EE	H1	H2
32	30	16	110	78	43	40	M8	M6	12	20	45	G1/8	53	3
40	35	16	120	88	51	50	M8	M6	12	20	54	G1/4	61	3
50	40	17	148	110	64	60	M8	M8	12	25	64	G1/4	73	3
63	45	17	162	125	80	80	M10	M8	12	25	75	G3/8	84	3

∅	H3 <sup>1)</sup>	H4	H5	H6	J1	J2	L1	L2	L3	L4	L5
32	2.5	30	13	5.6	5.3	5.3	177.6 +1.9/-1.2	7.4	99	45 +1.5/-1.1	40
40	3	30	17	5.6	4	4	183.5 +1.9/-1.3	7.5	99	45 +1.5/-1.1	40
50	2	40	18	7.5	5.5	5.5	193.5 +1.7/-1.3	7.7	105	50 +1.3/-1.2	40
63	2	40	23.5	9.3	6.3	6.3	207.3 +1.7/-1.3	7.5	105	50 +1.3/-1.2	40

∅	L6	L7	LA1	PL	PL1	RT	T1	T2	T3	TG	VA	WH	⊙ 1
32	14	20.4	5.6	19.5	88	M6	17	26	2.6	32.5	4	10.6 +1/-0.9	4
40	14	20.5	5.6	22.5	83	M6	17	26	2.6	38	4	10.5 ±1/-1	4
50	16	22.7	6.1	22.5	89	M8	17	20	2.6	46.5	4	11.3 +0.8/-1	4
63	20	18.5	6.1	27.5	88	M8	17	24	2.6	56.5	4	11.5 +0.8/-1	4

1) Only in combination with sensor mounting rail (DGRF-...-R)

2) Tolerance between the centring holes ±0.02 mm

3) Two centring sleeves included in the scope of delivery

## Ordering data – Modular product system

Ordering table									
Size	20	25	32	40	50	63	Condi- tions	Code	Enter code
Module no.	<b>562216</b>	<b>562217</b>	<b>563366</b>	<b>562219</b>	<b>562220</b>	<b>562221</b>			
Function	Guided drive							<b>DGRF</b>	DGRF
Product version	Easy-to-clean design							<b>-C</b>	-C
Guide	Plain-bearing guide							<b>-GF</b>	-GF
Piston diameter [mm]	20	25	32	40	50	63		<b>-...</b>	
Stroke [mm]	10 ... 400							<b>-...</b>	
Cushioning	Elastic cushioning rings at both ends			-				<b>-P</b>	
	-			Pneumatic cushioning, adjustable at both ends				<b>-PPV</b>	
	-			Pneumatic cushioning, self-adjusting at both ends				<b>-PPS</b>	
Position sensing	-		Via proximity sensor				[1]	<b>A</b>	
Sensor mounting, external	-		Mounting rail for proximity sensor				[1]	<b>-R</b>	
Wiper variant	Standard								
	For unlubricated operation							<b>-A3</b>	

[1] A, R Always present with piston diameter 32 ... 63.

## Accessories

Permissible with DGRF-...-PPV<sup>1)</sup>/-PPS:

Ordering data – Proximity sensor for T-slot, magneto-resistive

Data sheets → Internet: smt

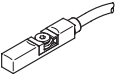
	Type of mounting	Switching output	Electrical connection	Cable length [m]	Part no.	Type
<b>N/O contact</b>						
	Inserted in the slot from above, flush with the mounting kit	PNP	Cable, 3-wire	5.0	574380	CRSMT-8M-PS-24V-K-5.0-OE
			Cable, 3-wire	10.0	574381	CRSMT-8M-PS-24V-K-10.0-OE
			Plug M8x1, 3-pin	0.3	574383	CRSMT-8M-PS-24V-K-0.3-M8D
			Plug M12x1, 3-pin	0.3	574382	CRSMT-8M-PS-24V-K-0.3-M12

1) Possible when ordering drives from 02/2014 (series E2).

Ordering data – Mounting kit

	Description	Part no.	Type
	For fitting the proximity sensor CRSMT-8M on the mounting rail	1806790	SMB-8-C

Permissible with DGRF-...-P/-PPV/-PPS:

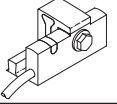

Ordering data – Proximity sensor for T-slot, magneto-resistive

Data sheets → Internet: smt







	Type of mounting	Switching output	Electrical connection	Cable length [m]	Part no.	Type
<b>N/O contact</b>						
	Fitted on the mounting rail	PNP	Cable, 3-wire	5.0	571339	SMT-C1-PS-24V-K-5.0-OE
			Plug M8x1, 3-pin	0.3	571342	SMT-C1-PS-24V-K-0.3-M8D
			Plug M12x1, 3-pin	0.3	571341	SMT-C1-PS-24V-K-0.3-M12

Ordering data – Connecting cables for SMT-C1-...

Data sheets → Internet: nebu



	Electrical connection, left	Electrical connection, right	Cable length [m]	Part no.	Type
	Straight socket, M8x1, 3-pin	Cable, open end, 3-wire	2.5	541333	NEBU-M8G3-K-2.5-LE3
			5	541334	NEBU-M8G3-K-5-LE3
	Straight socket, M12x1, 5-pin	Cable, open end, 3-wire	2.5	541363	NEBU-M12G5-K-2.5-LE3
			5	541364	NEBU-M12G5-K-5-LE3
	Angled socket, M8x1, 3-pin	Cable, open end, 3-wire	2.5	541338	NEBU-M8W3-K-2.5-LE3
			5	541341	NEBU-M8W3-K-5-LE3
	Angled socket, M12x1, 5-pin	Cable, open end, 3-wire	2.5	541367	NEBU-M12W5-K-2.5-LE3
			5	541370	NEBU-M12W5-K-5-LE3

## Accessories

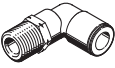

Ordering data – Push-in fittings							Data sheets → Internet: qs			
	Connection Thread	Tubing O.D.	Material	Weight [g]	Part no.	Type	PU <sup>2)</sup>			
<b>With external hex</b>										
	M5	4	High-alloy stainless steel	4.2	1857681	NPCK-C-D-M5-K4	1			
		G1/8		6	14.1	1366257		NPCK-C-D-G18-K6		
				8	13.4	1490383		NPCK-C-D-G18-K8		
	G1/4	8		28.85	1691701	NPCK-C-D-G14-K8				
		10		32.9	1489336	NPCK-C-D-G14-K10				
	G3/8	10		51.15	1489614	NPCK-C-D-G38-K10				
	M5	4	Nickel-plated brass, with sealing ring	5.8	578334	NPQH-D-M5-Q4-P10	10			
		G1/8		6	11.2	578335		NPQH-D-M5-Q6-P10		
				6	6.3	578338		NPQH-D-G18-Q4-P10		
	8				9.2	578339		NPQH-D-G18-Q6-P10		
	G1/4	8		11.9	578340	NPQH-D-G18-Q8-P10				
		10		13.1	578341	NPQH-D-G14-Q6-P10				
		14.1		578342	NPQH-D-G14-Q8-P10					
	G3/8	10		17.5	578343	NPQH-D-G14-Q10-P10				
		8		20.6	578345	NPQH-D-G38-Q8-P10				
		10		22.7	578346	NPQH-D-G38-Q10-P10				
	12	29.8		578347	NPQH-D-G38-Q12-P10					
		M5		4	Stainless steel	6.0		162860	CRQS-M5-4 <sup>1)</sup>	1
R1/8			6	8.4		162861	CRQS-M5-6 <sup>1)</sup>			
			4	8.7		132643	CRQS-1/8-4			
		6	9.9	162862		CRQS-1/8-6				
R1/4		8	12	162863		CRQS-1/8-8				
		6	18	132644		CRQS-1/4-6				
		8	18	162864		CRQS-1/4-8				
R3/8		10	22	162865		CRQS-1/4-10				
		10	29	162866		CRQS-3/8-10				
		12	37	162867		CRQS-3/8-12				
		R1/8	4	Polypropylene		2.5	133041	NPQP-D-R18-Q4-FD-P10	10	
			6			3.0	133043	NPQP-D-R18-Q6-FD-P10		
	8				4.5	133045	NPQP-D-R18-Q8-FD-P10			
	R1/4	6	3.5		133044	NPQP-D-R14-Q6-FD-P10				
		8	4.5		133046	NPQP-D-R14-Q8-FD-P10				
		10	7.0		133047	NPQP-D-R14-Q10-FD-P10				
	R3/8	10	8.0		133048	NPQP-D-R38-Q10-FD-P10				
		12	12.0		133049	NPQP-D-R38-Q12-FD-P10				
<b>With internal hex</b>										
	M5	4	Nickel-plated brass, with sealing ring	4.5	578370	NPQH-DK-M5-Q4-P10	10			
		6		8.8	578371	NPQH-DK-M5-Q6-P10				
				4	6.2	578374		NPQH-DK-G18-Q4-P10		
	G1/8	8		9.1	578375	NPQH-DK-G18-Q6-P10				
		12.8		578376	NPQH-DK-G18-Q8-P10					
	G1/4	8		14.4	578377	NPQH-DK-G14-Q8-P10				
G3/8	10	18.6	578378	NPQH-DK-G14-Q10-P10						
	12	28.2	578379	NPQH-DK-G38-Q12-P10						
	M5	4	Stainless steel	5	132328	CRQS-M5-4-1 <sup>1)</sup>	1			
		6		7.7	132329	CRQS-M5-6-1 <sup>1)</sup>				
	R1/8	6		8.4	132330	CRQS-1/8-6-I				
		8		12	132331	CRQS-1/8-8-I				
	R1/4	8		15	132332	CRQS-1/4-8-I				
		10		21	132333	CRQS-1/4-10-I				
	R3/8	10		24	132334	CRQS-3/8-10-I				

- 1) With sealing ring
- 2) Packaging unit

## Accessories

Ordering data – Push-in L-fittings						Data sheets → Internet: qs	
	Connection Thread	Tubing O.D.	Material	Weight [g]	Part no.	Type	PU <sup>2)</sup>
<b>With external hex</b>							
	M5	4	Nickel-plated brass, with sealing ring	8.9	578276	NPQH-L-M5-Q4-P10	10
		6		12.2	578277	NPQH-L-M5-Q6-P10	
	G1/8	4		16.3	578280	NPQH-L-G18-Q4-P10	
		6		19.3	578281	NPQH-L-G18-Q6-P10	
		8		22.2	578282	NPQH-L-G18-Q8-P10	
	G1/4	6		22.4	578283	NPQH-L-G14-Q6-P10	
		8		25.8	578284	NPQH-L-G14-Q8-P10	
		10		33.1	578285	NPQH-L-G14-Q10-P10	
		12		59.6	578286	NPQH-L-G14-Q12-P10	
	G3/8	8		36.7	578287	NPQH-L-G38-Q8-P10	
		10		38.2	578288	NPQH-L-G38-Q10-P10	
		12		58.2	578289	NPQH-L-G38-Q12-P10	
	M5	4	Stainless steel	12	162870	CRQSL-M5-4 <sup>1)</sup>	1
		6		18	162871	CRQSL-M5-6 <sup>1)</sup>	
	R1/8	4		14	132598	CRQSL-1/8-4	
		6		19	162872	CRQSL-1/8-6	
		8		26	162873	CRQSL-1/8-8	
	R1/4	6		26	132599	CRQSL-1/4-6	
		8		30	162874	CRQSL-1/4-8	
		10		42	162875	CRQSL-1/4-10	
	R3/8	10		49	162876	CRQSL-3/8-10	
		12		65	162877	CRQSL-3/8-12	
		R1/8		4	Polypropylene	4.0	
6			5.0	133053		NPQP-L-R18-Q6-FD-P10	
8			7.0	133055		NPQP-L-R18-Q8-FD-P10	
R1/4		6	5.5	133054		NPQP-L-R14-Q6-FD-P10	
		8	7.5	133056		NPQP-L-R14-Q8-FD-P10	
		10	12	133057		NPQP-L-R14-Q10-FD-P10	
R3/8		10	13	133058		NPQP-L-R38-Q10-FD-P10	
		12	18	133059		NPQP-L-R38-Q12-FD-P10	



- 1) With sealing ring  
2) Packaging unit

Ordering data – One-way flow control valves						Data sheets → Internet: crgria	
	Connection Thread	For push-in fitting	Material	Part no.	Type	PU <sup>1)</sup>	
	M5	CRQS/CRQSL/CRQST, QS	Electropolished stainless steel casting	161403	CRGRIA-M5-B	1	
	G1/8			161404	CRGRIA-1/8-B		
	G1/4			161405	CRGRIA-1/4-B		
	G3/8			161406	CRGRIA-3/8-B		
	G1/8	Push-in connector is integrated	Nickel-plated brass	578797	VFOH-LE-A-G18-Q4	1	
				578798	VFOH-LE-A-G18-Q6		
				578799	VFOH-LE-A-G18-Q8		
	G1/4			578800	VFOH-LE-A-G14-Q8		
				578801	VFOH-LE-A-G14-Q10		

- 1) Packaging unit

## Accessories

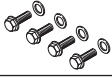
Ordering data – Plastic tubing, standard O.D.		Type	Data sheets → Internet: tubing
	Approved for use in the food zone and resistant to hydrolysis	<b>PUN-H</b>	
	Good resistance to chemicals and hydrolysis	<b>PLN</b>	
	Pneumatic tubing with resistance to high temperatures and chemicals	<b>PFAN</b>	

Ordering data – Plug screws, corrosion-resistant					PU <sup>1)</sup>
	For Ø	Description	Part no.	Type	
<b>For mounting thread on the guide</b>					
	20, 25	With cover plate	<b>543715</b>	<b>DAMD-P-M6-12-R1</b>	4
	32, 40, 50		<b>543716</b>	<b>DAMD-P-M8-16-R1</b>	
	63		<b>543717</b>	<b>DAMD-P-M10-16-R1</b>	
<b>For mounting thread on the end cap</b>					
	20, 25	With cover plate	<b>543714</b>	<b>DAMD-P-M5-10-R1</b>	4
	32 <sup>2)</sup>		<b>543715</b>	<b>DAMD-P-M6-12-R1</b>	
	32 <sup>3)</sup> , 40	–	<b>1355016</b>	<b>DAMD-PS-M6-12-R1</b>	
	50, 63		<b>650121</b>	<b>DAMD-PS-M8-16-R1</b>	

1) Packaging unit

2) For drives with P cushioning

3) For drives with PPV/PPS cushioning

Ordering data – Centring sleeves		Type	Data sheets → Internet: zbh
	For Ø	Part no.	PU <sup>1)</sup>
	20, 25	<b>8137184</b>	10
	32, 40, 50, 63	<b>8137185</b>	

1) Packaging unit

# Festo - Your Partner in Automation



**1 Festo Inc.**  
 5300 Explorer Drive  
 Mississauga, ON L4W 5G4  
 Canada

**Festo Customer Interaction Center**  
 Tel: 1 877 463 3786  
 Fax: 1 877 393 3786  
 Email: [customer.service.ca@festo.com](mailto:customer.service.ca@festo.com)



**2 Festo Pneumatic**  
 Av. Ceylán 3,  
 Col. Tequesquináhuac  
 54020 Tlalnepantla,  
 Estado de México

**Multinational Contact Center**  
 01 800 337 8669  
[ventas.mexico@festo.com](mailto:ventas.mexico@festo.com)



**3 Festo Corporation**  
 1377 Motor Parkway  
 Suite 310  
 Islandia, NY 11749

**Festo Customer Interaction Center**  
 1 800 993 3786  
 1 800 963 3786  
[customer.service.us@festo.com](mailto:customer.service.us@festo.com)



**4 Regional Service Center**  
 7777 Columbia Road  
 Mason, OH 45040

Connect with us



[www.festo.com/socialmedia](http://www.festo.com/socialmedia)



[www.festo.com](http://www.festo.com)

Subject to change