

Angle seat valves VZXF

FESTO



Festo core product range
Covers 80% of your automation tasks

Worldwide:

Always in stock

Superb:

Festo quality at an attractive price

Easy:

Simplified procurement and warehousing

★ Generally ready for dispatch from the factory within 24 hours

In stock at 13 Service Centres worldwide

More than 2200 products

★ Generally ready for dispatch from the factory within 5 days

Assembled for you at 4 Service Centres worldwide

Up to 6×10^{12} variants per product family

Just look
for the
star!

Characteristics



Function

Angle seat valves are externally controlled valves. They are directly actuated using compressed air supply. In this process, the seat of the process valve is raised by a pneumatic actuator. In the normal position, the valve is closed by a spring. When the

actuator is supplied with operating pressure, it raises the control piston as well as the valve disc – the valve opens. The valve seat is slanted at an angle of approx. 50° in relation to the media flow. The flow direction is determined by the design of the valve.

Angle seat valves are used in applications in which absolute purity of the medium cannot be ensured, in which high-viscosity media are to be controlled or in vapour applications.

Design

-  - Connecting thread
G1/2 ... G2
-  - Flow rate Kv
3.3 ... 47.5 m³/h

- Gunmetal (red brass) variant
- Stainless steel casting variant
- Stainless steel casting variant, nickel-plated actuator head

General information

- Angle seat valves are simple and sturdy and are thus perfectly suitable for almost all media with a viscosity of up to 600 mm²/s
- Angle seat valves control suitable gaseous and liquid media in rigid piping systems without the need for any pressure differential
- No differential pressure required between the input and output
- Low flow resistance
- Insensitive to vapour or slightly contaminated media
- Long service life
- Low maintenance
- The valves have a high chemical and thermal resistance thanks to their design
- The NC function ensures that the valve is closed in the event of pressure loss in the control circuit
- Angle seat valves are available in different designs depending on the pressure of the medium
- There is a choice of two versions: "closing in the direction of media flow" is used for gaseous media. "Closing against the direction of media flow" is used for liquid media

PWIS-free

- PWIS-free is chosen for use in production areas in which the influence of paint-wetting impairment substances must be avoided at all costs

Vacuum version

- The version that is suitable for vacuum is used in packaging machines which need to generate a vacuum

Characteristics

Examples of versions, each available with G or NPT thread

VZXF-L...-M-A...112-350-H3B1-50-8

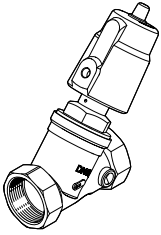

VZXF-L...-M-A...112-350-M1-V4V4T-50-7

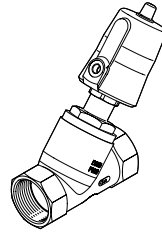

VZXF-L...-M-A...12-120-M1-H3B1-50-16

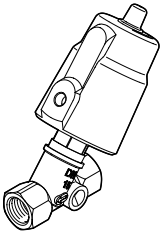

VZXF-L...-M-B...12-130-M1-V4V4T-50-40

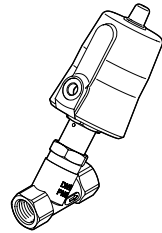

VZXF-L...-M-B...2-430-H3B1-50-3

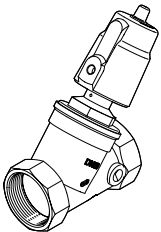

VZXF-L...-M-B...2-450-M1-V4V4T-50-3

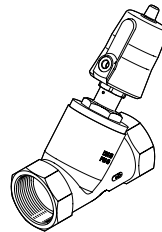

Product range overview

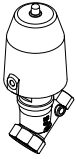
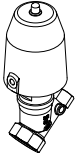
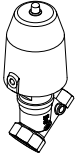
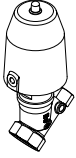
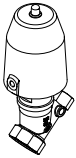
Version with G thread	Type	Valve connection	Nominal width DN	Temperature of medium [°C]	Flow rate Kv [m³/h]	Valve nom. pressure PN	→ Page/Internet	
Gunmetal (red brass)	Temperature of medium –10 ... +80°C							
		VZXF-L...-H3B1-...	G1/2	15	–10 ... +80	3.5 ... 28	16	7
			G3/4	20				
			G1	25				
			G1 1/4	32				
			G1 1/2	40				
			G2	50				
	Temperature of medium –40 ... +200°C							
		VZXF-L...-H3B1T-..., VZXF-L...-H3ALT-...	G1/2	15	–40 ... +200	3.5 ... 40	16	10
			G3/4	20				
			G1	25				
			G1 1/4	32				
			G1 1/2	40				
			G2	50				
	Vacuum version							
		VZXF-L...-H3B1V-..., VZXF-L...-H3ALV-...	G1/2	15	–10 ... +80	3.5 ... 40	16	14
			G3/4	20				
			G1	25				
G1 1/4			32					
G1 1/2			40					
G2			50					
PWIS-free								
	VZXF-L...-H3B1V-...	G1/2	15	–10 ... +80	3.7 ... 16.5	16	16	
		G3/4	20					
		G1	25					
		G1 1/2	40					
Gunmetal (red brass)	Temperature of medium –10 ... +80°C							
		VZXF-L...-H3B1-...	1/2 NPT	15	–10 ... +80	3.5 ... 28	16	26
			3/4 NPT	20				
			1 NPT	25				
			1 1/4 NPT	32				
			1 1/2 NPT	40				
			2 NPT	50				

Product range overview

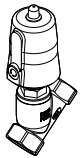
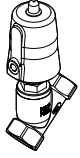
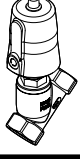
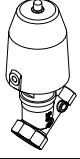
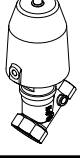
Version with G thread	Type	Valve connection	Nominal width DN	Temperature of medium [°C]	Flow rate Kv [m³/h]	Valve nom. pressure PN	→ Page/Internet	
Stainless steel casting	Temperature of medium –40 ... +200°C							
		VZXF-L...-V4V4T...	G1/2	15	–40 ... +200	3.3 ... 43	40	18
			G3/4	20				
			G1	25				
			G1 1/4	32				
			G1 1/2	40				
			G2	50				
	Nickel-plated actuator head							
		VZXF-L...-V4B2T..., VZXF-L...-V4ANT...	G1/2	15	–40 ... +200	3.3 ... 43	40	21
			G3/4	20				
			G1	25				
			G1 1/4	32				
			G1 1/2	40				
			G2	50				
	Vacuum version							
		VZXF-L...-V4B2V..., VZXF-L...-V4ANV...	G1/2	15	–10 ... +80	3.8 ... 43	40	24
			G3/4	20				
			G1	25				
G1 1/4			32					
G1 1/2			40					
G2			50					
Version with NPT thread	Temperature of medium –40 ... +200°C							
		VZXF-L...-V4V4T...	1/2 NPT	15	–40 ... +200	3.3 ... 43	40	28
			3/4 NPT	20				
			1 NPT	25				
			1 1/4 NPT	32				
			1 1/2 NPT	40				
			2 NPT	50				
	Nickel-plated actuator head							
		VZXF-L...-V4B2T...	1/2 NPT	15	–40 ... +200	3.3 ... 34.5	40	32
			3/4 NPT	20				
			1 NPT	25				
			1 1/4 NPT	32				
			1 1/2 NPT	40				
			2 NPT	50				

Type codes

001	Series	
VZXF	Angle seat valve	

002	Directional control valve type	
L	In-line valve	

003	Valve function	
M22C	2/2-way valve, normally closed	

004	Reset method for monostable/single solenoid valves	
M	Mechanical spring	

005	Flow direction	
A	Above valve seat, for gaseous media	
B	Below valve seat, for gaseous and liquid media	

006	Process valve connection	
G12	G1/2	
G34	G3/4	
G1	G1	
G114	G1 1/4	
G112	G1 1/2	
G2	G2	
N12	1/2 NPT	
N34	3/4 NPT	
N1	1 NPT	
N114	1 1/4 NPT	
N112	1 1/2 NPT	
N2	2 NPT	

007	Nominal width	
120	12 mm	
130	13 mm	
160	16 mm	
180	18 mm	
230	23 mm	
240	24 mm	
290	29 mm	
310	31 mm	
350	35 mm	
430	43 mm	
450	45 mm	

008	Temperature of medium	
	Standard	
M1	-40 ... 200°C	

009	Housing material	
H3	Gunmetal (red brass)	
V4	Stainless steel (chrome-nickel-molybdenum, austenitic/1.4401, 1.4404 (AISI 316L), 1.4408)	

010	Drive housing material	
AL	Aluminium	
AN	Aluminium, nickel-plated	
B1	Brass	
B2	Brass, nickel-plated	
V4	Stainless steel 1.4408	

011	Spindle seal material	
	Standard (NBR)	
T	PTFE	
V	FPM	

012	Drive size	
50	50 mm	
80	80 mm	

013	Medium pressure	
V	-0.9 ... 0 bar	
3	0 ... 3 bar	
4	0 ... 4 bar	
5	0 ... 5 bar	
6	0 ... 6 bar	
7	0 ... 7 bar	
8	0 ... 8 bar	
9	0 ... 9 bar	
10	0 ... 10 bar	
12	0 ... 12 bar	
16	0 ... 16 bar	
20	0 ... 20 bar	
22	0 ... 22 bar	
40	0 ... 40 bar	

014	PWIS content	
	Standard	
C	Free of PWIS	

Gunmetal (red brass), temperature of medium –10 ... +80°C

Function

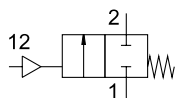

-  - Flow rate Kv
3.5 ... 28 m³/h

-  - Connecting thread
G1/2 ... G2



General technical data		G1/2	G3/4	G1	G1 1/4	G1 1/2	G2
Line connection		G1/2	G3/4	G1	G1 1/4	G1 1/2	G2
Nominal width DN	[mm]	12	16	23	29	35	43
Design	Poppet valve with piston drive						
Actuation type	Pneumatic						
Type of mounting	In-line installation						
Line connection	Threaded coupling to DIN ISO 228-1						
Sealing principle	Soft						
Mounting position	Any						
Valve function	2/2-way, closed, monostable						
Pneumatic connection	Female thread G1/8						
Flow direction	Non-reversible						
Type of control	Externally piloted						
Reset method	Mechanical spring						
Exhaust air function	Cannot be throttled						
Flow direction	VZXF-...-A-...	Over valve seat, for gaseous media					
	VZXF-...-B-...	Under valve seat, for gaseous and liquid media					

Operating and environmental conditions		G1/2	G3/4	G1	G1 1/4	G1 1/2	G2
Line connection		G1/2	G3/4	G1	G1 1/4	G1 1/2	G2
Valve nominal pressure PN		16					
Operating medium		Compressed air to ISO 8573-1:2010 [7:4:4]					
Operating pressure	[bar]	6 ... 10					
Medium		Vapour					
		Inert gases					
		Filtered compressed air, grade of filtration 200 µm					
	VZXF-...-B-... additionally	Mineral oil-based hydraulic fluid					
		Mineral oil					
		Neutral fluids					
		Water					
Max. viscosity	[mm ² /s]	600					
Ambient temperature	[°C]	–10 ... +60					
Temperature of medium	[°C]	–10 ... +80					
CE marking (see declaration of conformity) ¹⁾		–				To EU Pressure Equipment Directive	

1) Additional information is available at www.festo.com/sp → Certificates.

Materials	Material number
Valve housing	Gunmetal (red brass) CC499K
Actuator housing	Brass
Spindle seal	NBR
Seat seal	PTFE
Note on materials	Contains paint-wetting impairment substances RoHS-compliant

Angle seat valves VZXF

Gunmetal (red brass), temperature of medium –10 ... +80°C

Dimensions

Download CAD data → www.festo.com

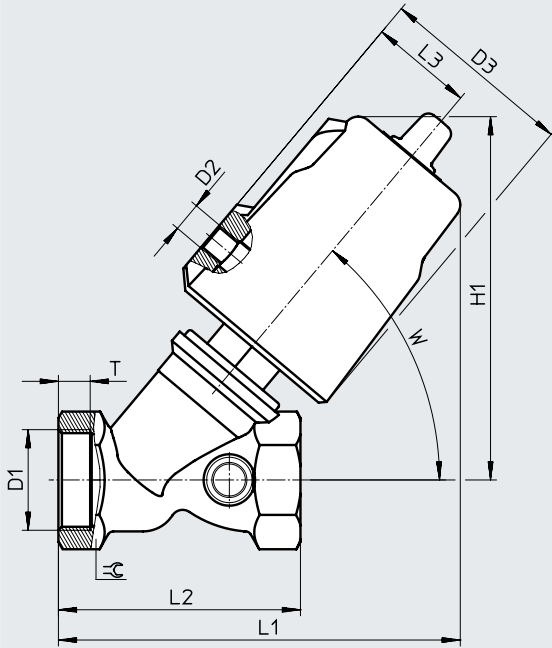

Type	D1	D2	D3 ∅	H1	L1	L2	L3	T	W	∠
VZXF-L-...-G12-...	G1/2	G1/8	62	112	123	66	34	8	50°	27
VZXF-L-...-G34-...	G3/4			117	130	75		9		33
VZXF-L-...-G1-...	G1			121	133	80		10.5		41
VZXF-L-...-G114-...	G1 1/4			139	154	97		12.5		50
VZXF-L-...-G112-...	G1 1/2			145	161	107		14.5		56
VZXF-L-...-G2-...	G2			154	171	124		16.5		68

Gunmetal (red brass), temperature of medium –10 ... +80°C

★ Core product range

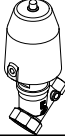
Ordering data							
	Line connection	Flow rate Kv [m³/h]	Pressure of medium [bar]	Corrosion resistance CRC ¹⁾	Product weight [g]	Part no.	Type
	G1/2	3.7	0 ... 16	1	1200	★ 1002501	VZXF-L-M22C-M-B-G12-120-H3B1-50-16
	G3/4	5.2	0 ... 16		1300	★ 1002503	VZXF-L-M22C-M-B-G34-160-H3B1-50-16
	G1	9.6	0 ... 10		1500	★ 1002505	VZXF-L-M22C-M-B-G1-230-H3B1-50-10

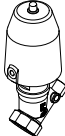
Ordering data							
	Line connection	Flow rate Kv [m³/h]	Pressure of medium [bar]	Corrosion resistance CRC ¹⁾	Product weight [g]	Part no.	Type
	G1/2	3.5	0 ... 16	1	1200	1002500	VZXF-L-M22C-M-A-G12-120-H3B1-50-16
	G3/4	6.7	0 ... 16		1300	1002502	VZXF-L-M22C-M-A-G34-160-H3B1-50-16
	G1	10.8	0 ... 16		1500	1002504	VZXF-L-M22C-M-A-G1-230-H3B1-50-16
	G1 1/4	6	0 ... 7		1900	1002507	VZXF-L-M22C-M-B-G114-290-H3B1-50-7
		19	0 ... 10			1002506	VZXF-L-M22C-M-A-G114-290-H3B1-50-10
	G1 1/2	16.5	0 ... 6		2300	1002509	VZXF-L-M22C-M-B-G112-350-H3B1-50-6
		23				1002508	VZXF-L-M22C-M-A-G112-350-H3B1-50-8
	G2	23	0 ... 3		2800	1002511	VZXF-L-M22C-M-B-G2-430-H3B1-50-3
		28	0 ... 4			1002510	VZXF-L-M22C-M-A-G2-430-H3B1-50-4

1) Corrosion resistance class CRC 1 to Festo standard FN 940070

Low corrosion stress. Dry internal application or transport and storage protection. Also applies to parts behind coverings, in the non-visible interior area, and parts which are covered in the application (e.g. drive trunnions).

Festo core product range



Generally ready for dispatch from the factory within 24 hours

Generally ready for dispatch from the factory within 5 days

Angle seat valves VZXF

Gunmetal (red brass), temperature of medium –40 ... +200°C

Function

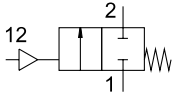

-  - Flow rate Kv
3.5 ... 40 m³/h

-  - Connecting thread
G1/2 ... G2

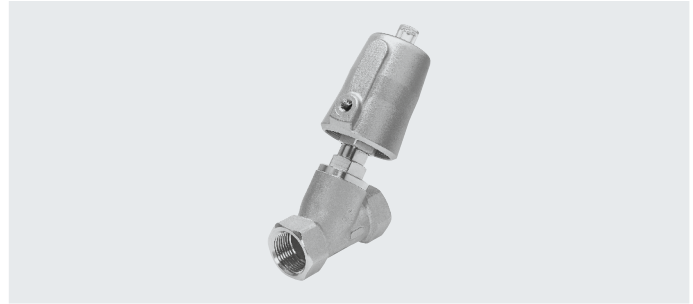

General technical data

Line connection	G1/2	G3/4	G1	G1 1/4	G1 1/2	G2
Nominal width DN [mm]	12	16	23	29	35	43
Design	Poppet valve with piston drive					
Actuation type	Pneumatic					
Type of mounting	In-line installation					
Line connection	Threaded coupling to DIN ISO 228-1					
Sealing principle	Soft					
Mounting position	Any					
Valve function	2/2-way, closed, monostable					
Pneumatic connection	Female thread G1/8					
Flow direction	Non-reversible					
Type of control	Externally piloted					
Reset method	Mechanical spring					
Exhaust air function	Cannot be throttled					
Flow direction	VZXF-...-A-...	Over valve seat, for gaseous media				
	VZXF-...-B-...	Under valve seat, for gaseous and liquid media				

Gunmetal (red brass), temperature of medium –40 ... +200°C

Operating and environmental conditions		G1/2	G3/4	G1	G1 1/4	G1 1/2	G2	
Line connection								
Valve nominal pressure PN		16						
Operating medium		Compressed air to ISO 8573-1:2010 [7:4:4]						
Operating pressure	[bar]	6 ... 10						
Medium		Vapour						
		Inert gases						
		Filtered compressed air, grade of filtration 200 µm						
	VZXF...-B... additionally	Mineral oil-based hydraulic fluid						
		Mineral oil						
		Neutral fluids						
		Water						
Max. viscosity	[mm ² /s]	600						
Ambient temperature	[°C]	–10 ... +60						
Temperature of medium	[°C]	–40 ... +200						
CE marking (see declaration of conformity) ¹⁾		–					To EU Pressure Equipment Directive	

1) Additional information is available at www.festo.com/sp → Certificates.

Materials		Material number
Valve housing		Gunmetal (red brass)
Actuator housing	...-H3ALT...	Aluminium
	...-H3B1T...	Brass
Spindle seal		PTFE
Seat seal		PTFE
Note on materials		Contains paint-wetting impairment substances
		RoHS-compliant

Gunmetal (red brass), temperature of medium -40 ... +200°C

Dimensions

Download CAD data → www.festo.com

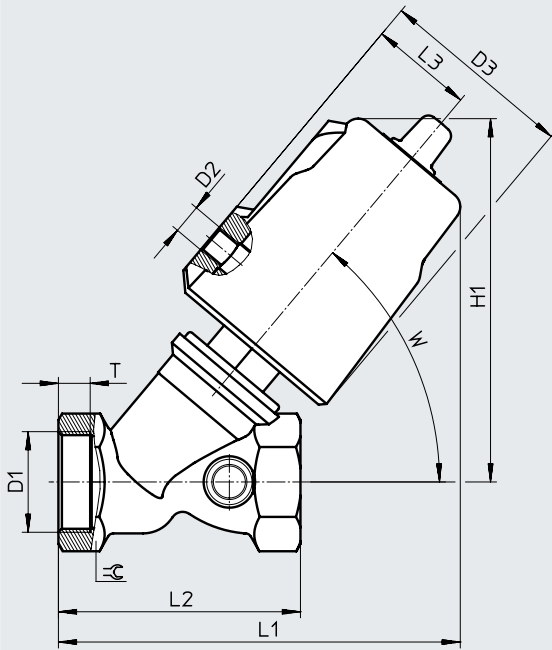

Type	D1	D2	D3 ∅	H1	L1	L2	L3	T	W	∠
VZXF-L-...-G12-...-H3B1T-50-...	G1/2	G1/8	62	130	135.5	66	34	13	50°	27
VZXF-L-...-G34-...-H3B1T-50-...	G3/4			130	140	75		14.5		32
VZXF-L-...-G1-...-H3B1T-50-...	G1			133	143	80		10.5		41
VZXF-L-...-G114-...-H3B1T-50-...	G1 1/4			148	160	97		12.5		50
VZXF-L-...-G114-...-H3ALT-80-...	G1 1/4		94	180	190	97	49	12.5		50
VZXF-L-...-G112-...-H3B1T-50-...	G1 1/2		62	152.5	167	107	34	14.5		55
VZXF-L-...-G112-...-H3ALT-80-...	G1 1/2		94	186	197	107	49	14.5		55
VZXF-L-...-G2-...-H3B1T-50-...	G2		62	162	178	124	34	16.5		67
VZXF-L-...-G2-...-H3ALT-80-...	G2		94	196	207.5	124	49	16.5		67

Gunmetal (red brass), temperature of medium $-40 \dots +200^{\circ}\text{C}$

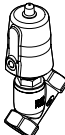
Ordering data							
	Line connection	Flow rate Kv [m ³ /h]	Pressure of medium [bar]	Corrosion resistance CRC ¹⁾	Product weight [g]	Part no.	Type
	G1/2	3.5	0 ... 16	1	1200	3535619	VZXF-L-M22C-M-A-G12-120-M1-H3B1T-50-16
		3.7				3535620	VZXF-L-M22C-M-B-G12-120-M1-H3B1T-50-16
	G3/4	5.2	0 ... 16	1	1300	3535644	VZXF-L-M22C-M-B-G34-160-M1-H3B1T-50-16
		6.7				3535643	VZXF-L-M22C-M-A-G34-160-M1-H3B1T-50-16
	G1	9.6	0 ... 10	1	1500	3535665	VZXF-L-M22C-M-B-G1-230-M1-H3B1T-50-10
		10.8	0 ... 16	1		3535664	VZXF-L-M22C-M-A-G1-230-M1-H3B1T-50-16
		14.5	0 ... 16	0	2000	3540768	VZXF-L-M22C-M-B-G1-230-M1-H3ALT-80-16
	G1 1/4	6	0 ... 7	1	1900	3535689	VZXF-L-M22C-M-B-G114-290-M1-H3B1T-50-7
		19	0 ... 10	1		3535684	VZXF-L-M22C-M-A-G114-290-M1-H3B1T-50-10
		19	0 ... 12	0	2300	3535712	VZXF-L-M22C-M-B-G114-290-M1-H3ALT-80-12
		21.5	0 ... 16	0		3535711	VZXF-L-M22C-M-A-G114-290-M1-H3ALT-80-16
	G1 1/2	16.5	0 ... 6	1	2300	3535721	VZXF-L-M22C-M-B-G112-350-M1-H3B1T-50-6
		23	0 ... 7	1		3535720	VZXF-L-M22C-M-A-G112-350-M1-H3B1T-50-7
		29.5	0 ... 8	0	2600	3535825	VZXF-L-M22C-M-B-G112-350-M1-H3ALT-80-8
		30.5	0 ... 16	0		3535824	VZXF-L-M22C-M-A-G112-350-M1-H3ALT-80-16
	G2	23	0 ... 3	1	2800	3535838	VZXF-L-M22C-M-B-G2-430-M1-H3B1T-50-3
		28	0 ... 4	1		3535837	VZXF-L-M22C-M-A-G2-430-M1-H3B1T-50-4
		30	0 ... 5	0	2900	3536436	VZXF-L-M22C-M-B-G2-430-M1-H3ALT-80-5
		40	0 ... 16	0		3536435	VZXF-L-M22C-M-A-G2-430-M1-H3ALT-80-16

1) Corrosion resistance class CRC 0 to Festo standard FN 940070

No corrosion stress. Applies to small, visually unimportant standard parts such as threaded pins, circlips and clamping sleeves which are usually only available on the market in a phosphated or burnished version (and possibly oiled) as well as to ball bearings (for components < CRC 3) and plain bearings.

Corrosion resistance class CRC 1 to Festo standard FN 940070

Low corrosion stress. Dry internal application or transport and storage protection. Also applies to parts behind coverings, in the non-visible interior area, and parts which are covered in the application (e.g. drive trunnions).

Angle seat valves VZXF

Gunmetal (red brass), vacuum version

Function

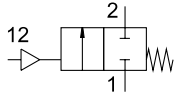

-  - Flow rate Kv
3.5 ... 40 m³/h

-  - Connecting thread
G1/2 ... G2



General technical data

Line connection	G1/2	G3/4	G1	G1 1/4	G1 1/2	G2
Nominal width DN [mm]	12	16	23	29	35	43
Design	Poppet valve with piston drive					
Actuation type	Pneumatic					
Type of mounting	In-line installation					
Line connection	Threaded coupling to DIN ISO 228-1					
Sealing principle	Soft					
Mounting position	Any					
Valve function	2/2-way, closed, monostable					
Pneumatic connection	Female thread G1/8					
Flow direction	Non-reversible					
Type of control	Externally piloted					
Reset method	Mechanical spring					
Exhaust air function	Cannot be throttled					
Flow direction	Over valve seat, for gaseous media					

Operating and environmental conditions

Line connection	G1/2	G3/4	G1	G1 1/4	G1 1/2	G2
Valve nominal pressure PN	16					
Operating medium	Compressed air to ISO 8573-1:2010 [7:4:4]					
Operating pressure [bar]	6 ... 10					
Medium	Vapour					
	Inert gases					
	Filtered compressed air, grade of filtration 200 µm					
Max. viscosity [mm ² /s]	600					
Ambient temperature [°C]	-10 ... +60					
Temperature of medium [°C]	-10 ... +80					

Materials

	Material number
Valve housing	Gunmetal (red brass) CC499K
Actuator housing	Aluminium ...-H3ALV-... Brass ...-H3B1V-...
Spindle seal	FPM
Seat seal	FPM
Note on materials	Contains paint-wetting impairment substances RoHS-compliant

Gunmetal (red brass), vacuum version

Dimensions

Download CAD data → www.festo.com

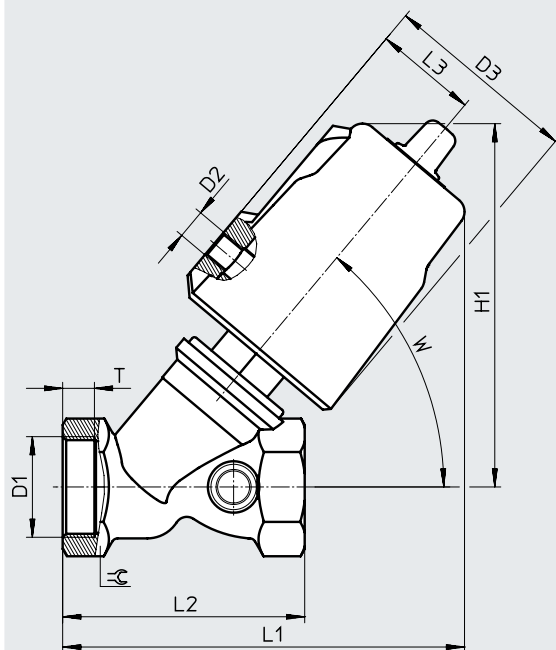

Type	D1	D2	D3 ∅	H1	L1	L2	L3	T	W	∠
VZXF-L-...-G12-...-H3B1V-50-...	G1/2	G1/8	62	113.5	123	66	34	13	50°	27
VZXF-L-...-G34-...-H3B1V-50-...	G3/4			118	130	75	34	14.5		32
VZXF-L-...-G1-...-H3B1V-50-...	G1			121	133	80	34	10.5		41
VZXF-L-...-G1-...-H3ALV-80-...	G1		94	168	174.5	80	49	10.5		41
VZXF-L-...-G114-...-H3B1V-50-...	G1 1/4		62	138.5	153.5	97	34	12.5		50
VZXF-L-...-G114-...-H3ALV-80-...	G1 1/4		94	174.5	185	97	49	12.5		50
VZXF-L-...-G112-...-H3B1V-50-...	G1 1/2		62	146	160	107	34	14.5		55
VZXF-L-...-G112-...-H3ALV-80-...	G1 1/2		94	180.5	192	107	49	14.5		55
VZXF-L-...-G2-...-H3ALV-80-...	G2		94	190	202.5	124	49	16.5		68

Ordering data

	Line connection	Flow rate Kv [m³/h]	Pressure of medium [bar]	Corrosion resistance CRC ¹⁾	Product weight [g]	Part no.	Type
	G1/2	3.5	-0.9	1	1200	3538869	VZXF-L-M22C-M-A-G12-120-H3B1V-50-V
	G3/4	6.7		1	1300	3539178	VZXF-L-M22C-M-A-G34-160-H3B1V-50-V
	G1	10.8		1	1500	3539247	VZXF-L-M22C-M-A-G1-230-H3B1V-50-V
		12		0	2000	3536819	VZXF-L-M22C-M-A-G1-230-H3ALV-80-V
	G1 1/4	19		1	1900	3539352	VZXF-L-M22C-M-A-G114-290-H3B1V-50-V
		21.5		0	2300	3536830	VZXF-L-M22C-M-A-G114-290-H3ALV-80-V
	G1 1/2	23		1	2300	3539367	VZXF-L-M22C-M-A-G112-350-H3B1V-50-V
		30.5		0	2600	3536850	VZXF-L-M22C-M-A-G112-350-H3ALV-80-V
	G2	40		0	2900	3540796	VZXF-L-M22C-M-A-G2-430-H3ALV-80-V

1) Corrosion resistance class CRC 0 to Festo standard FN 940070

No corrosion stress. Applies to small, visually unimportant standard parts such as threaded pins, circlips and clamping sleeves which are usually only available on the market in a phosphated or burnished version (and possibly oiled) as well as to ball bearings (for components < CRC 3) and plain bearings.

Corrosion resistance class CRC 1 to Festo standard FN 940070

Low corrosion stress. Dry internal application or transport and storage protection. Also applies to parts behind coverings, in the non-visible interior area, and parts which are covered in the application (e.g. drive trunnions).

Angle seat valves VZXF

Gunmetal (red brass), PWIS-free

Function

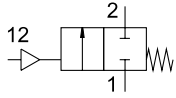

-  - Flow rate Kv
3.7 ... 16.5 m³/h

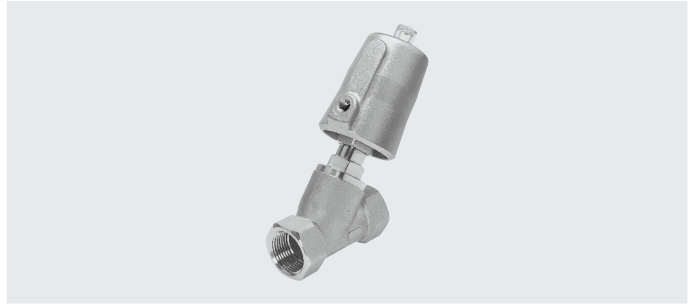

-  - Connecting thread
G1/2 ... G1 1/2

General technical data

Line connection	G1/2	G3/4	G1	G1 1/2
Nominal width DN [mm]	12	16	23	35
Design	Poppet valve with piston drive			
Actuation type	Pneumatic			
Type of mounting	In-line installation			
Line connection	Threaded coupling to DIN ISO 228-1			
Sealing principle	Soft			
Mounting position	Any			
Valve function	2/2-way, closed, monostable			
Pneumatic connection	Female thread G1/8			
Flow direction	Non-reversible			
Type of control	Externally piloted			
Reset method	Mechanical spring			
Exhaust air function	Cannot be throttled			
Flow direction	Under valve seat, for gaseous and liquid media			

Operating and environmental conditions

Line connection	G1/2	G3/4	G1	G1 1/2
Valve nominal pressure PN	16			
Operating medium	Compressed air to ISO 8573-1:2010 [7:4:4]			
Operating pressure [bar]	6 ... 10			
Medium	Vapour Inert gases Filtered compressed air, grade of filtration 200 µm Mineral oil-based hydraulic fluid Mineral oil Neutral fluids Water			
Max. viscosity [mm ² /s]	600			
Ambient temperature [°C]	-10 ... +60			
Temperature of medium [°C]	-10 ... +80			
CE marking (see declaration of conformity) ¹⁾	-			To EU Pressure Equipment Directive

1) Additional information is available at www.festo.com/sp → Certificates.

Materials

		Material number
Valve housing	Gunmetal (red brass)	CC499K
Actuator housing	Brass	
Spindle seal	FPM	
Seat seal	FPM	
Note on materials	RoHS-compliant	

Gunmetal (red brass), PWIS-free

Dimensions

Download CAD data → www.festo.com

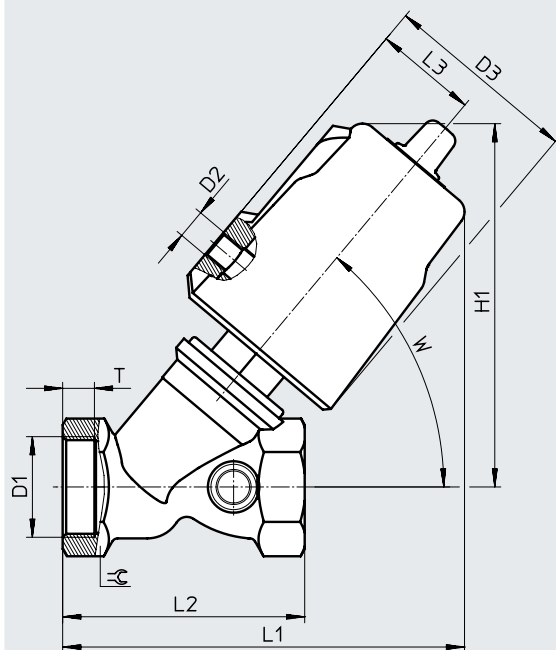

Type	D1	D2	D3 ∅	H1	L1	L2	L3	T	W	∠
VZXF-L...-G12-...	G1/2	G1/8	62	113.5	123	66	34	13	50°	27
VZXF-L...-G34-...	G3/4			118	130	75	34	14.5		32
VZXF-L...-G1-...	G1			121	133	80	34	10.5		41
VZXF-L...-G112-...	G1 1/2		62	146	160	107	34	14.5		55

Ordering data

	Line connection	Flow rate Kv [m³/h]	Pressure of medium [bar]	Corrosion resistance CRC ¹⁾	Product weight [g]	Part no.	Type
	G1/2	3.7	0 ... 16	1	1200	3539036	VZXF-L-M22C-M-B-G12-120-H3B1V-50-16-C
	G3/4	5.2	0 ... 16		1300	3539179	VZXF-L-M22C-M-B-G34-160-H3B1V-50-16-C
	G1	9.6	0 ... 10		1500	3539248	VZXF-L-M22C-M-B-G1-230-H3B1V-50-10-C
	G1 1/2	16.5	0 ... 6		2300	3539368	VZXF-L-M22C-M-B-G112-350-H3B1V-50-6-C

1) Corrosion resistance class CRC 1 to Festo standard FN 940070

Low corrosion stress. Dry internal application or transport and storage protection. Also applies to parts behind coverings, in the non-visible interior area, and parts which are covered in the application (e.g. drive trunnions).

Angle seat valves VZXF

Stainless steel casting, temperature of medium –40 ... +200°C

Function

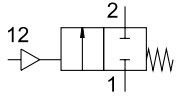

-  - Flow rate Kv
3.3 ... 43 m³/h

-  - Connecting thread
G1/2 ... G2

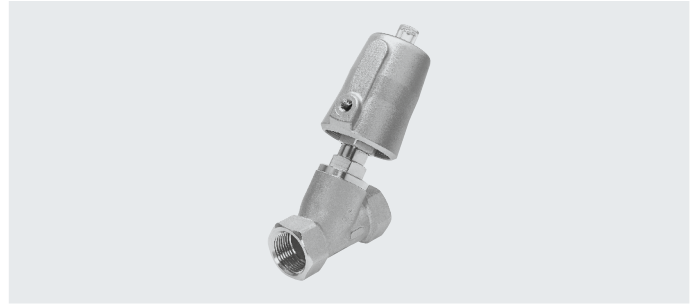

General technical data

Line connection	G1/2	G3/4	G1	G1 1/4	G1 1/2	G2
Nominal width DN [mm]	13	18	24	31	35	45
Design	Poppet valve with piston drive					
Actuation type	Pneumatic					
Type of mounting	In-line installation					
Line connection	Threaded coupling to DIN ISO 228-1					
Sealing principle	Soft					
Mounting position	Any					
Valve function	2/2-way, closed, monostable					
Pneumatic connection	Female thread G1/8					
Flow direction	Non-reversible					
Type of control	Externally piloted					
Reset method	Mechanical spring					
Exhaust air function	Cannot be throttled					
Flow direction	VZXF-...-A-...	Over valve seat, for gaseous media				
	VZXF-...-B-...	Under valve seat, for gaseous and liquid media				

Operating and environmental conditions

Line connection	G1/2	G3/4	G1	G1 1/4	G1 1/2	G2
Valve nominal pressure PN	40					
Operating medium	Compressed air to ISO 8573-1:2010 [7:4:4]					
Operating pressure [bar]	6 ... 10					
Medium	Vapour					
	Inert gases					
	Filtered compressed air, grade of filtration 200 µm					
	VZXF-...-B-... additionally	Mineral oil-based hydraulic fluid				
		Mineral oil				
		Neutral fluids				
		Water				
Max. viscosity [mm ² /s]	600					
Ambient temperature [°C]	–10 ... +60					
Temperature of medium [°C]	–40 ... +200					
CE marking (see declaration of conformity) ¹⁾	–					To EU Pressure Equipment Directive

1) Additional information is available at www.festo.com/sp → Certificates.

Materials

	Material number
Valve housing	Stainless steel casting 1.4408
Actuator housing	High-alloy stainless steel
Spindle seal	PTFE
Seat seal	PTFE
Note on materials	Contains paint-wetting impairment substances RoHS-compliant

Stainless steel casting, temperature of medium -40 ... +200°C

Dimensions

Download CAD data → www.festo.com

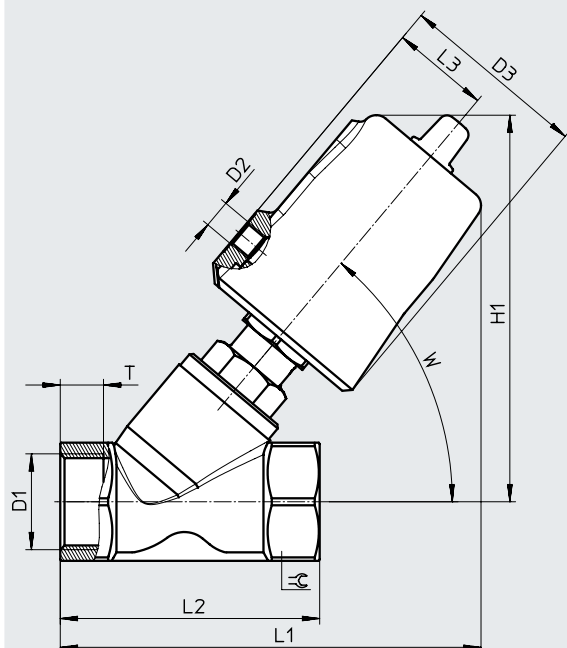

Type	D1	D2	D3 ∅	H1	L1	L2	L3	T	W	⊕
VZXF-L...-G12...-V4V4T-50-...	G1/2	G1/8	62	129	135	65	34	12	50°	27
VZXF-L...-G34...-V4V4T-50-...	G3/4		62	130	138	75	34	13		32
VZXF-L...-G1...-V4V4T-50-...	G1		62	135	146	90	34	15		42
VZXF-L...-G1...-V4V4T-80-...	G1		94	177	184		48			50
VZXF-L...-G114...-V4V4T-50-...	G1 1/4		62	151	155	110	34	17		50
VZXF-L...-G114...-V4V4T-80-...	G1 1/2		94	183	194		48			55
VZXF-L...-G112...-V4V4T-50-...	G1 1/2		62	155	174	120	34	19		55
VZXF-L...-G112...-V4V4T-80-...	G1 1/2		94	187	202		48			70
VZXF-L...-G2...-V4V4T-50-...	G2		62	167	193	150	34	21		70
VZXF-L...-G2...-V4V4T-80-...	G2		94	199	222		48			

Stainless steel casting, temperature of medium –40 ... +200°C

★ Core product range

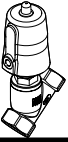
Ordering data							
	Line connection	Flow rate Kv [m³/h]	Pressure of medium [bar]	Corrosion resistance CRC ¹⁾	Product weight [g]	Part no.	Type
	G1/2	3.3	0 ... 40	3	1300	★ 1002513	VZXF-L-M22C-M-B-G12-130-M1-V4V4T-50-40
G3/4	6.5	0 ... 20	1400		★ 1002515	VZXF-L-M22C-M-B-G34-180-M1-V4V4T-50-20	
G1	11	0 ... 10	1600		★ 1002517	VZXF-L-M22C-M-B-G1-240-M1-V4V4T-50-10	

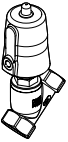
Ordering data							
	Line connection	Flow rate Kv [m³/h]	Pressure of medium [bar]	Corrosion resistance CRC ¹⁾	Product weight [g]	Part no.	Type
	G1/2	3.8	0 ... 16	3	1300	1002512	VZXF-L-M22C-M-A-G12-130-M1-V4V4T-50-16
G3/4	7.5	0 ... 16	1400		1002514	VZXF-L-M22C-M-A-G34-180-M1-V4V4T-50-16	
G1	12	0 ... 16	1600		1002516	VZXF-L-M22C-M-A-G1-240-M1-V4V4T-50-16	
	12	0 ... 22	3600		1002526	VZXF-L-M22C-M-B-G1-240-M1-V4V4T-80-22	
	12.5	0 ... 16	3600		1002525	VZXF-L-M22C-M-A-G1-240-M1-V4V4T-80-16	
G1 1/4	10.7	0 ... 7	2200		1002519	VZXF-L-M22C-M-B-G114-310-M1-V4V4T-50-7	
	17.5	0 ... 10	3800		1002528	VZXF-L-M22C-M-B-G114-310-M1-V4V4T-80-10	
	18.5	0 ... 9	2200		1002518	VZXF-L-M22C-M-A-G114-310-M1-V4V4T-50-9	
	19	0 ... 16	3800		1002527	VZXF-L-M22C-M-A-G114-310-M1-V4V4T-80-16	
G1 1/2	17.5	0 ... 6	2500		1002521	VZXF-L-M22C-M-B-G112-350-M1-V4V4T-50-6	
	25	0 ... 7	4300		1002520	VZXF-L-M22C-M-A-G112-350-M1-V4V4T-50-7	
	28	0 ... 8	4300		1002530	VZXF-L-M22C-M-B-G112-350-M1-V4V4T-80-8	
	29	0 ... 16	4300		1002529	VZXF-L-M22C-M-A-G112-350-M1-V4V4T-80-16	
G2	19.5	0 ... 3	3500		1002523	VZXF-L-M22C-M-B-G2-450-M1-V4V4T-50-3	
	34.5	0 ... 4	5400		1002522	VZXF-L-M22C-M-A-G2-450-M1-V4V4T-50-4	
	39	0 ... 5	5400		1002532	VZXF-L-M22C-M-B-G2-450-M1-V4V4T-80-5	
	43	0 ... 12	5400		1002531	VZXF-L-M22C-M-A-G2-450-M1-V4V4T-80-12	

1) Corrosion resistance class CRC 3 to Festo standard FN 940070

High corrosion stress. Outdoor exposure under moderate corrosive conditions. Externally visible parts with primarily functional surface requirements which are in direct contact with a normal industrial environment.



Stainless steel casting, nickel-plated actuator head

Function

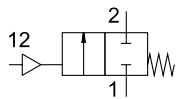

-  - Flow rate Kv
3.3 ... 43 m³/h

-  - G1/2 ... G2



General technical data		G1/2	G3/4	G1	G1 1/4	G1 1/2	G2
Line connection		G1/2	G3/4	G1	G1 1/4	G1 1/2	G2
Nominal width DN	[mm]	13	18	24	31	35	45
Design	Poppet valve with piston drive						
Actuation type	Pneumatic						
Type of mounting	In-line installation						
Line connection	Threaded coupling to DIN ISO 228-1						
Sealing principle	Soft						
Mounting position	Any						
Valve function	2/2-way, closed, monostable						
Pneumatic connection	Female thread G1/8						
Flow direction	Non-reversible						
Type of control	Externally piloted						
Reset method	Mechanical spring						
Exhaust air function	Cannot be throttled						
Flow direction	VZXF-...-A-...	Over valve seat, for gaseous media					
	VZXF-...-B-...	Under valve seat, for gaseous and liquid media					

Operating and environmental conditions		G1/2	G3/4	G1	G1 1/4	G1 1/2	G2
Line connection		G1/2	G3/4	G1	G1 1/4	G1 1/2	G2
Valve nominal pressure PN		40					
Operating medium		Compressed air to ISO 8573-1:2010 [7:4:4]					
Operating pressure	[bar]	6 ... 10					
Medium		Vapour					
		Inert gases					
		Filtered compressed air, grade of filtration 200 µm					
	VZXF-...-B-... additionally	Mineral oil-based hydraulic fluid					
		Mineral oil					
		Neutral fluids					
		Water					
Max. viscosity	[mm ² /s]	600					
Ambient temperature	[°C]	-10 ... +60					
Temperature of medium	[°C]	-40 ... +200					
CE marking (see declaration of conformity) ¹⁾		-				To EU Pressure Equipment Directive	

1) Additional information is available at www.festo.com/sp → Certificates.

Materials		Material number
Valve housing	Stainless steel casting	1.4408
Actuator housing	...-V4ANTF ...	Nickel-plated aluminium
	...-V4B2T ...	Nickel-plated brass
Spindle seal	PTFE	
Seat seal	PTFE	
Note on materials	Contains paint-wetting impairment substances	
	RoHS-compliant	

Stainless steel casting, nickel-plated actuator head

Dimensions

Download CAD data → www.festo.com

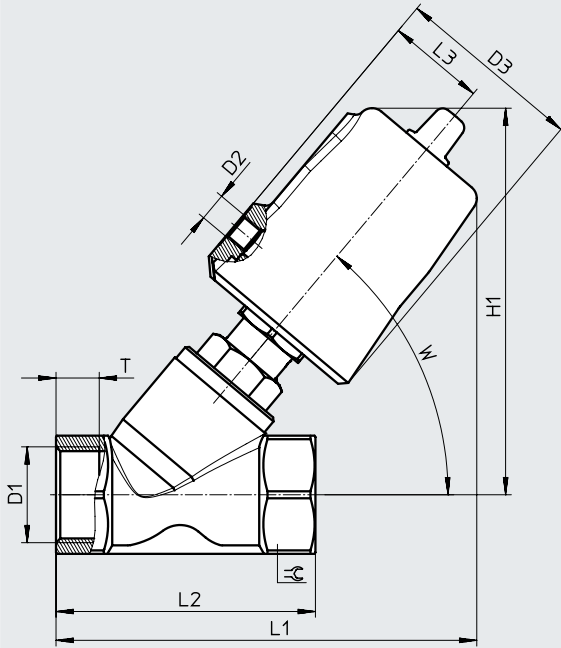

Type	D1	D2	D3 ∅	H1	L1	L2	L3	T	W	∠
VZXF-L-...-G12-...-V4B2T-50-...	G1/2	G1/8	62	128	133	65	34	12	50°	27
VZXF-L-...-G34-...-V4B2T-50-...	G3/4		62	128	136.5	75		13		32
VZXF-L-...-G1-...-V4B2T-50-...	G1		62	133	145	90		15		41
VZXF-L-...-G1-...-V4ANT-80-...			94	176.5	183	90	49	15		41
VZXF-L-...-G114-...-V4B2T-50-...	G1 1/4		62	150	163.5	110	34	17		50
VZXF-L-...-G114-...-V4ANT-80-...			94	183	193	110		17		50
VZXF-L-...-G112-...-V4B2T-50-...	G1 1/2		62	153	172	120		19		55
VZXF-L-...-G112-...-V4ANT-80-...			94	187	202	120		19		55
VZXF-L-...-G2-...-V4B2T-50-...	G2		62	167	193	150		21		70
VZXF-L-...-G2-...-V4ANT-80-...			94	199	221.5	150		49		21

Stainless steel casting, nickel-plated actuator head

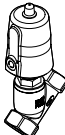
Ordering data							
Line connection	Flow rate Kv [m ³ /h]	Pressure of medium [bar]	Corrosion resistance CRC ¹⁾	Product weight [g]	Part no.	Type	
	G1/2	3.3	0 ... 40	2	1300	3539720	VZXF-L-M22C-M-B-G12-130-M1-V4B2T-50-40
	G3/4	6.5	0 ... 20	2	1400	3538842	VZXF-L-M22C-M-B-G34-180-M1-V4B2T-50-20
		7.5	0 ... 16			3539745	VZXF-L-M22C-M-A-G34-180-M1-V4B2T-50-16
	G1	11	0 ... 10	2	1600	3539783	VZXF-L-M22C-M-B-G1-240-M1-V4B2T-50-10
		12	0 ... 16	2	1600	3539782	VZXF-L-M22C-M-A-G1-240-M1-V4B2T-50-16
		12	0 ... 22	1	3600	3540198	VZXF-L-M22C-M-B-G1-240-M1-V4ANT-80-22
	G1 1/4	10.7	0 ... 7	2	2200	3539816	VZXF-L-M22C-M-B-G114-310-M1-V4B2T-50-7
		17.5	0 ... 10	1	3800	3540818	VZXF-L-M22C-M-B-G114-310-M1-V4ANT-80-10
		18.5	0 ... 9	2	2200	3539815	VZXF-L-M22C-M-A-G114-310-M1-V4B2T-50-9
		19	0 ... 16	1	3800	3540817	VZXF-L-M22C-M-A-G114-310-M1-V4ANT-80-16
	G1 1/2	17.5	0 ... 6	2	2500	3539927	VZXF-L-M22C-M-B-G112-350-M1-V4B2T-50-6
		25	0 ... 7	2	2500	3539926	VZXF-L-M22C-M-A-G112-350-M1-V4B2T-50-7
		28	0 ... 8	1	4300	3540250	VZXF-L-M22C-M-B-G112-350-M1-V4ANT-80-8
		29	0 ... 16	1	4300	3540248	VZXF-L-M22C-M-A-G112-350-M1-V4ANT-80-16
	G2	19.5	0 ... 3	2	3500	3540146	VZXF-L-M22C-M-B-G2-450-M1-V4B2T-50-3
		34.5	0 ... 4	2	3500	3540145	VZXF-L-M22C-M-A-G2-450-M1-V4B2T-50-4
		39	0 ... 5	1	5400	3540277	VZXF-L-M22C-M-B-G2-450-M1-V4ANT-80-5
		43	0 ... 12	1	5400	3540276	VZXF-L-M22C-M-A-G2-450-M1-V4ANT-80-12

1) Corrosion resistance class CRC 1 to Festo standard FN 940070

Low corrosion stress. Dry internal application or transport and storage protection. Also applies to parts behind coverings, in the non-visible interior area, and parts which are covered in the application (e.g. drive trunnions).

Corrosion resistance class CRC 2 to Festo standard FN 940070

Moderate corrosion stress. Indoor applications in which condensation can occur. External visible parts with primarily decorative surface requirements which are in direct contact with a normal industrial environment.

Stainless steel casting, vacuum version

Function

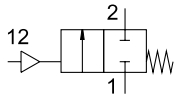

-  - Flow rate Kv
3.8 ... 43 m³/h

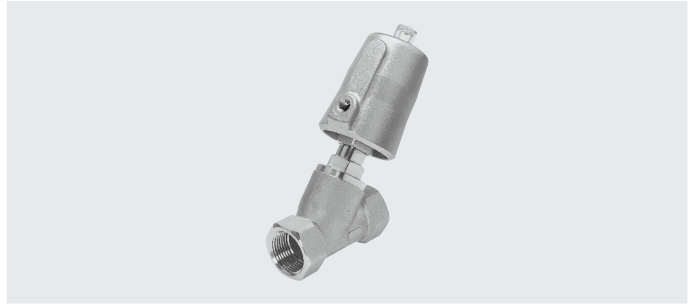

-  - G1/2 ... G2

General technical data

Line connection	G1/2	G3/4	G1	G1 1/4	G1 1/2	G2
Nominal width DN [mm]	13	18	24	31	35	45
Design	Poppet valve with piston drive					
Actuation type	Pneumatic					
Type of mounting	In-line installation					
Line connection	Threaded coupling to DIN ISO 228-1					
Sealing principle	Soft					
Mounting position	Any					
Valve function	2/2-way, closed, monostable					
Pneumatic connection	Female thread G1/8					
Flow direction	Non-reversible					
Type of control	Externally piloted					
Reset method	Mechanical spring					
Exhaust air function	Cannot be throttled					
Flow direction	Over valve seat, for gaseous media					

Operating and environmental conditions

Line connection	G1/2	G3/4	G1	G1 1/4	G1 1/2	G2
Valve nominal pressure PN	40					
Operating medium	Compressed air to ISO 8573-1:2010 [7:4:4]					
Operating pressure [bar]	6 ... 10					
Medium	Vapour Inert gases Filtered compressed air, grade of filtration 200 µm					
Max. viscosity [mm ² /s]	600					
Ambient temperature [°C]	-10 ... +60					
Temperature of medium [°C]	-10 ... +80					

Materials

Material number

Valve housing	Stainless steel casting	1.4408
Actuator housing	...-V4ANV-... ...-V4B2V-...	Nickel-plated aluminium Nickel-plated brass
Spindle seal	FPM	
Seat seal	FPM	
Note on materials	Contains paint-wetting impairment substances RoHS-compliant	

Stainless steel casting, vacuum version

Dimensions

Download CAD data → www.festo.com

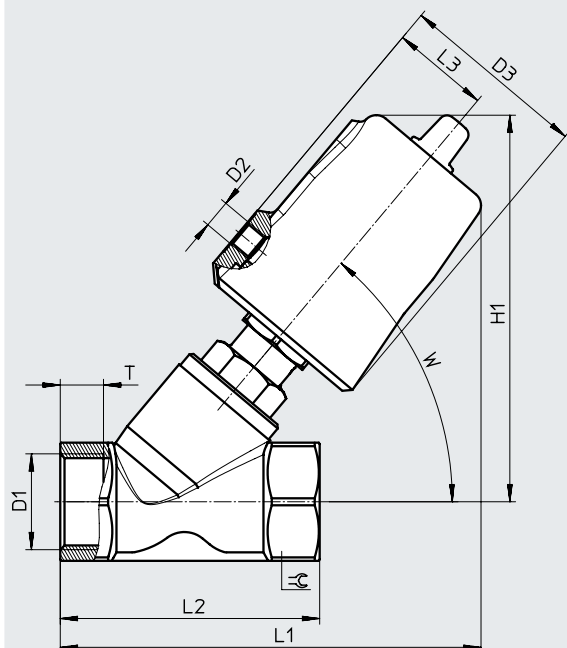

Type	D1	D2	D3 ∅	H1	L1	L2	L3	T	W	∠
VZXF-L...-G12...-V4B2V-50...	G1/2	G1/8	62	112	119	65	34	12	50°	27
VZXF-L...-G34...-V4B2V-50...	G3/4		62	118	126.5	75	34	13		32
VZXF-L...-G1...-V4B2V-50...	G1		62	121.5	135	90	34	15		41
VZXF-L...-G1...-V4ANV-80...			94	169	176	90	49	15		41
VZXF-L...-G114...-V4B2V-50...	G1 1/4		62	142.5	156.5	110	34	17		50
VZXF-L...-G114...-V4ANV-80...			94	177	188	110	49	17		50
VZXF-L...-G112...-V4B2V-50...	G1 1/2		62	146	165	120	34	19		55
VZXF-L...-G112...-V4ANV-80...			94	181	197	120	49	19		55
VZXF-L...-G2...-V4ANV-80...	G2	94	193	216.5	150	49	21	70		

Ordering data

	Line connection	Flow rate Kv [m³/h]	Pressure of medium [bar]	Corrosion resistance CRC ¹⁾	Product weight [g]	Part no.	Type
	G1/2	3.8	-0.9	2	1300	3536502	VZXF-L-M22C-M-A-G12-130-V4B2V-50-V
	G3/4	7.5		2	1400	3536650	VZXF-L-M22C-M-A-G34-180-V4B2V-50-V
	G1	12		2	1600	3536659	VZXF-L-M22C-M-A-G34-180-V4B2V-50-V
				1	3600	3536677	VZXF-L-M22C-M-A-G1-240-V4ANV-80-V
	G1 1/4	18.5		2	2200	3536686	VZXF-L-M22C-M-A-G114-310-V4B2V-50-V
				1	3800	3536711	VZXF-L-M22C-M-A-G114-310-V4ANV-80-V
	G1 1/2	25		2	2500	3536717	VZXF-L-M22C-M-A-G112-350-V4B2V-50-V
				1	4300	3536771	VZXF-L-M22C-M-A-G112-350-V4ANV-80-V
G2	43	1	5400	3536786	VZXF-L-M22C-M-A-G2-450-V4ANV-80-V		

1) Corrosion resistance class CRC 1 to Festo standard FN 940070
 Low corrosion stress. Dry internal application or transport and storage protection. Also applies to parts behind coverings, in the non-visible interior area, and parts which are covered in the application (e.g. drive trunnions).
 Corrosion resistance class CRC 2 to Festo standard FN 940070
 Moderate corrosion stress. Indoor applications in which condensation can occur. External visible parts with primarily decorative surface requirements which are in direct contact with a normal industrial environment.

Angle seat valves VZXF, NPT

Gunmetal (red brass), temperature of medium –10 ... +80°C

Function

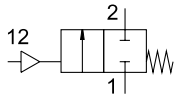

-  - Flow rate Kv
3.5 ... 28 m³/h

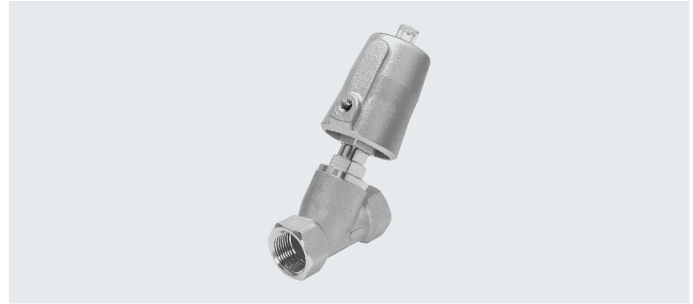

-  - 1/2 NPT ... 2 NPT

General technical data

Line connection	1/2 NPT	3/4 NPT	1 NPT	1 1/4 NPT	1 1/2 NPT	2 NPT
Nominal width DN [mm]	12	16	23	29	35	43
Design	Poppet valve with piston drive					
Actuation type	Pneumatic					
Type of mounting	In-line installation					
Line connection	Threaded coupling to ANSI/ASME B 1.20.1					
Sealing principle	Soft					
Mounting position	Any					
Valve function	2/2-way, closed, monostable					
Pneumatic connection	Female thread G1/8					
Flow direction	Non-reversible					
Type of control	Externally piloted					
Reset method	Mechanical spring					
Exhaust air function	Cannot be throttled					
Flow direction	VZXF-...-A-...	Over valve seat, for gaseous media				
	VZXF-...-B-...	Under valve seat, for gaseous and liquid media				

Operating and environmental conditions

Line connection	1/2 NPT	3/4 NPT	1 NPT	1 1/4 NPT	1 1/2 NPT	2 NPT
Valve nominal pressure PN	16					
Operating medium	Compressed air to ISO 8573-1:2010 [7:4:4]					
Operating pressure [bar]	6 ... 10					
Medium	Vapour					
	Inert gases					
	Filtered compressed air, grade of filtration 200 µm					
	VZXF-...-B-... additionally	Mineral oil-based hydraulic fluid				
		Mineral oil				
		Neutral fluids				
		Water				
Max. viscosity [mm ² /s]	600					
Ambient temperature [°C]	–10 ... +60					
Temperature of medium [°C]	–10 ... +80					
CE marking (see declaration of conformity) ¹⁾	-				To EU Pressure Equipment Directive	

1) Additional information is available at www.festo.com/sp → Certificates.

Materials

Materials	Material number
Valve housing	Gunmetal (red brass) CC499K
Actuator housing	Brass
Spindle seal	NBR
Seat seal	PTFE
Note on materials	Contains paint-wetting impairment substances RoHS-compliant

Gunmetal (red brass), temperature of medium -10 ... +80°C

Dimensions

Download CAD data → www.festo.com

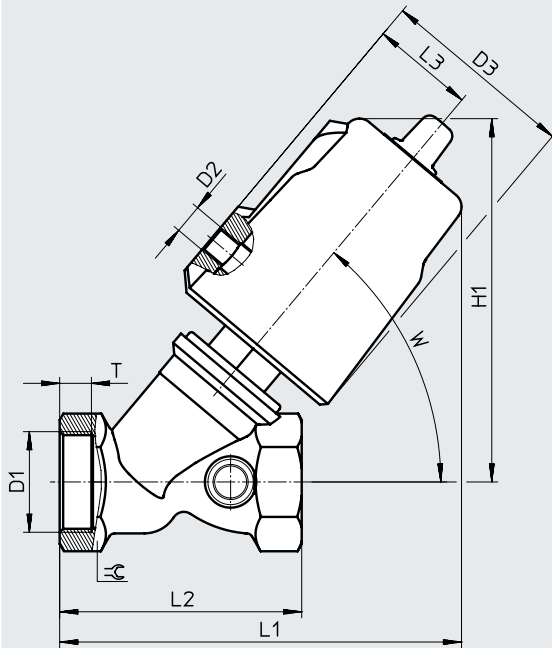

Type	D1	D2	D3 ∅	H1	L1	L2	L3	T	W	∠
VZXF-L-...-N12-...-H3B1-50-...	1/2 NPT	G1/8	62	112	123	66	34	8	50°	27
VZXF-L-...-N34-...-H3B1-50-...	3/4 NPT			117	130	75		9		33
VZXF-L-...-N1-...-H3B1-50-...	1 NPT			121	133	80		10.5		41
VZXF-L-...-N114-...-H3B1-50-...	1 1/4 NPT			139	154	97		12.5		50
VZXF-L-...-N112-...-H3B1-50-...	1 1/2 NPT			145	161	107		14.5		56
VZXF-L-...-N2-...-H3B1-50-...	2 NPT			154	171	124		16.5		68

Ordering data

	Line connection	Flow rate Kv [m³/h]	Pressure of medium [bar]	Corrosion resistance CRC ¹⁾	Product weight [g]	Part no.	Type
	1/2 NPT	3.5	0 ... 16	1	1200	1002533	VZXF-L-M22C-M-A-N12-120-H3B1-50-16
		3.7				1002534	VZXF-L-M22C-M-B-N12-120-H3B1-50-16
	3/4 NPT	6.7	0 ... 16		1300	1002535	VZXF-L-M22C-M-A-N34-160-H3B1-50-16
		5.2				1002536	VZXF-L-M22C-M-B-N34-160-H3B1-50-16
	1 NPT	10.8	0 ... 16		1500	1002537	VZXF-L-M22C-M-A-N1-230-H3B1-50-16
		9.6				1002538	VZXF-L-M22C-M-B-N1-230-H3B1-50-10
	1 1/4 NPT	19	0 ... 10		1900	1002539	VZXF-L-M22C-M-A-N114-290-H3B1-50-10
		6				1002540	VZXF-L-M22C-M-B-N114-290-H3B1-50-7
	1 1/2 NPT	23	0 ... 8		2300	1002541	VZXF-L-M22C-M-A-N112-350-H3B1-50-8
		16.5				1002542	VZXF-L-M22C-M-B-N112-350-H3B1-50-6
	2 NPT	28	0 ... 4		2800	1002543	VZXF-L-M22C-M-A-N2-430-H3B1-50-4
		23				1002544	VZXF-L-M22C-M-B-N2-430-H3B1-50-3

1) Corrosion resistance class CRC 1 to Festo standard FN 940070

Low corrosion stress. Dry internal application or transport and storage protection. Also applies to parts behind coverings, in the non-visible interior area, and parts which are covered in the application (e.g. drive trunnions).

Angle seat valves VZXF, NPT

Stainless steel casting, temperature of medium –40 ... +200°C

Function

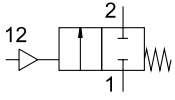

-  - Flow rate Kv
3.3 ... 43 m³/h



-  - 1/2 NPT ... 2 NPT

General technical data

Line connection	1/2 NPT	3/4 NPT	1 NPT	1 1/4 NPT	1 1/2 NPT	2 NPT
Nominal width DN [mm]	13	18	24	31	35	45
Design	Poppet valve with piston drive					
Actuation type	Pneumatic					
Type of mounting	In-line installation					
Line connection	Threaded coupling to ANSI/ASME B 1.20.1					
Sealing principle	Soft					
Mounting position	Any					
Valve function	2/2-way, closed, monostable					
Pneumatic connection	Female thread G1/8					
Flow direction	Non-reversible					
Type of control	Externally piloted					
Reset method	Mechanical spring					
Exhaust air function	Cannot be throttled					
Flow direction	VZXF-...-A...	Over valve seat, for gaseous media				
	VZXF-...-B...	Under valve seat, for gaseous and liquid media				

Stainless steel casting, temperature of medium –40 ... +200°C

Operating and environmental conditions		1/2 NPT	3/4 NPT	1 NPT	1 1/4 NPT	1 1/2 NPT	2 NPT
Line connection							
Valve nominal pressure PN		40					
Operating medium		Compressed air to ISO 8573-1:2010 [7:4:4]					
Operating pressure	[bar]	6 ... 10					
Medium		Vapour					
		Inert gases					
		Filtered compressed air, grade of filtration 200 µm					
	VZXF-...-B-... additionally	Mineral oil-based hydraulic fluid					
		Mineral oil					
		Neutral fluids					
		Water					
Max. viscosity	[mm ² /s]	600					
Ambient temperature	[°C]	–10 ... +60					
Temperature of medium	[°C]	–40 ... +200					
CE marking (see declaration of conformity) ¹⁾		–				To EU Pressure Equipment Directive	

1) Additional information is available at www.festo.com/sp → Certificates.

Materials	Material number
Valve housing	Stainless steel casting 1.4408
Actuator housing	High-alloy stainless steel
Spindle seal	PTFE
Seat seal	PTFE
Note on materials	Contains paint-wetting impairment substances
	RoHS-compliant

Stainless steel casting, temperature of medium -40 ... +200°C

Dimensions

Download CAD data → www.festo.com

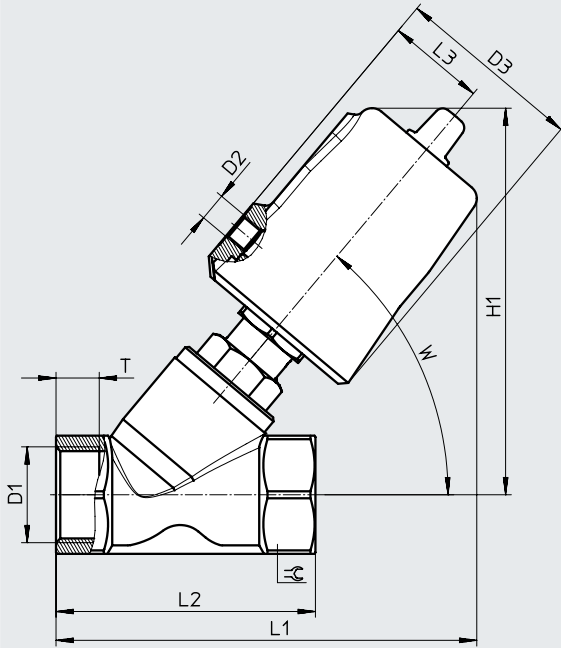

Type	D1	D2	D3 ∅	H1	L1	L2	L3	T	W	⊖
VZXF-L-...-N12-...-V4V4T-50-...	1/2 NPT	G1/8	62	129	135	65	34	12	50°	27
VZXF-L-...-N34-...-V4V4T-50-...	3/4 NPT			130	138	75		13		32
VZXF-L-...-N1-...-V4V4T-50-...	1 NPT			135	146	90		15		42
VZXF-L-...-N1-...-V4V4T-80-...	1 NPT		94	177	184	48	50			
VZXF-L-...-N114-...-V4V4T-50-...	1 1/4 NPT		62	151	155	110		34		17
VZXF-L-...-N114-...-V4V4T-80-...	1 1/4 NPT		94	183	194	48	55			
VZXF-L-...-N112-...-V4V4T-50-...	1 1/2 NPT		62	155	174	120		34		19
VZXF-L-...-N112-...-V4V4T-80-...	1 1/2 NPT		94	187	202	48	70			
VZXF-L-...-N2-...-V4V4T-50-...	2 NPT		62	167	193	150		34		21
VZXF-L-...-N2-...-V4V4T-80-...	2 NPT		94	199	222	48				

Stainless steel casting, temperature of medium $-40 \dots +200^{\circ}\text{C}$

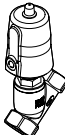
Ordering data								
	Line connection	Flow rate Kv [m ³ /h]	Pressure of medium [bar]	Corrosion resistance CRC ¹⁾	Product weight [g]	Part no.	Type	
	1/2 NPT	3.8	0 ... 16	3	1300	1002545	VZXF-L-M22C-M-A-N12-130-M1-V4V4T-50-16	
		3.3	0 ... 40			1002546	VZXF-L-M22C-M-B-N12-130-M1-V4V4T-50-40	
	3/4 NPT	7.5	0 ... 16		1400	1002547	VZXF-L-M22C-M-A-N34-180-M1-V4V4T-50-16	
		6.5	0 ... 20			1002548	VZXF-L-M22C-M-B-N34-180-M1-V4V4T-50-20	
	1 NPT	12	0 ... 16		1600	1002549	VZXF-L-M22C-M-A-N1-240-M1-V4V4T-50-16	
		11	0 ... 10			1002550	VZXF-L-M22C-M-B-N1-240-M1-V4V4T-50-10	
		12.5	0 ... 16			3600	1002551	VZXF-L-M22C-M-A-N1-240-M1-V4V4T-80-16
		12	0 ... 22				1002552	VZXF-L-M22C-M-B-N1-240-M1-V4V4T-80-22
	1 1/4 NPT	18.5	0 ... 9		2200	1002553	VZXF-L-M22C-M-A-N114-310-M1-V4V4T-50-9	
		10.7	0 ... 7			1002554	VZXF-L-M22C-M-B-N114-310-M1-V4V4T-50-7	
		19	0 ... 16		3800	1002555	VZXF-L-M22C-M-A-N114-310-M1-V4V4T-80-16	
		17.5	0 ... 10			1002556	VZXF-L-M22C-M-B-N114-310-M1-V4V4T-80-10	
	1 1/2 NPT	25	0 ... 7		2500	1002557	VZXF-L-M22C-M-A-N112-350-M1-V4V4T-50-7	
		17.5	0 ... 6			1002558	VZXF-L-M22C-M-B-N112-350-M1-V4V4T-50-6	
		29	0 ... 16		4300	1002559	VZXF-L-M22C-M-A-N112-350-M1-V4V4T-80-16	
		28	0 ... 8			1002560	VZXF-L-M22C-M-B-N112-350-M1-V4V4T-80-8	
	2 NPT	34.5	0 ... 4		3500	1002561	VZXF-L-M22C-M-A-N2-450-M1-V4V4T-50-4	
		19.5	0 ... 3			1002562	VZXF-L-M22C-M-B-N2-450-M1-V4V4T-50-3	
		43	0 ... 12		5400	1002563	VZXF-L-M22C-M-A-N2-450-M1-V4V4T-80-12	
		39	0 ... 5			1002564	VZXF-L-M22C-M-B-N2-450-M1-V4V4T-80-5	

1) Corrosion resistance class CRC 3 to Festo standard FN 940070

High corrosion stress. Outdoor exposure under moderate corrosive conditions. Externally visible parts with primarily functional surface requirements which are in direct contact with a normal industrial environment.

Angle seat valves VZXF, NPT

Stainless steel casting, nickel-plated actuator head

Function

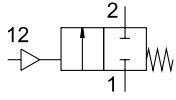

-  - Flow rate Kv
3.3 ... 34.5 m³/h



-  - 1/2 NPT ... 2 NPT

General technical data		1/2 NPT	3/4 NPT	1 NPT	1 1/4 NPT	1 1/2 NPT	2 NPT
Line connection		1/2 NPT	3/4 NPT	1 NPT	1 1/4 NPT	1 1/2 NPT	2 NPT
Nominal width DN	[mm]	13	18	24	31	35	45
Design	Poppet valve with piston drive						
Actuation type	Pneumatic						
Type of mounting	In-line installation						
Line connection	Threaded coupling to ANSI/ASME B 1.20.1						
Sealing principle	Soft						
Mounting position	Any						
Valve function	2/2-way, closed, monostable						
Pneumatic connection	Female thread G1/8						
Flow direction	Non-reversible						
Type of control	Externally piloted						
Reset method	Mechanical spring						
Exhaust air function	Cannot be throttled						
Flow direction	VZXF-...-A-...	Over valve seat, for gaseous media					
	VZXF-...-B-...	Under valve seat, for gaseous and liquid media					

Operating and environmental conditions		1/2 NPT	3/4 NPT	1 NPT	1 1/4 NPT	1 1/2 NPT	2 NPT
Line connection		1/2 NPT	3/4 NPT	1 NPT	1 1/4 NPT	1 1/2 NPT	2 NPT
Valve nominal pressure PN		40					
Operating medium		Compressed air to ISO 8573-1:2010 [7:4:4]					
Operating pressure	[bar]	6 ... 10					
Medium		Vapour					
		Inert gases					
		Filtered compressed air, grade of filtration 200 µm					
	VZXF-...-B-... additionally	Mineral oil-based hydraulic fluid					
		Mineral oil					
		Neutral fluids					
		Water					
Max. viscosity	[mm ² /s]	600					
Ambient temperature	[°C]	-10 ... +60					
Temperature of medium	[°C]	-40 ... +200					
CE marking (see declaration of conformity) ¹⁾		-				To EU Pressure Equipment Directive	

1) Additional information is available at www.festo.com/sp → Certificates.

Materials	Material number
Valve housing	Stainless steel casting 1.4408
Actuator housing	Nickel-plated brass
Spindle seal	PTFE
Seat seal	PTFE
Note on materials	Contains paint-wetting impairment substances RoHS-compliant

Stainless steel casting, nickel-plated actuator head

Dimensions

Download CAD data → www.festo.com

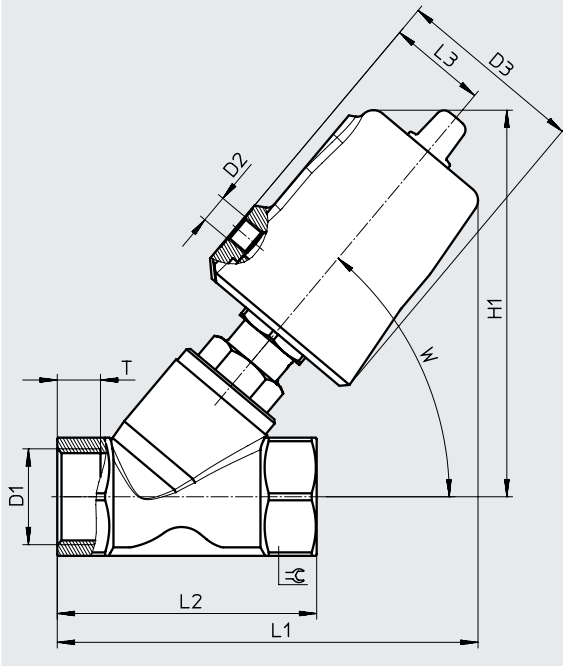

Type	D1	D2	D3 ∅	H1	L1	L2	L3	T	W	∠
VZXF-L...-N12...-V4B2T-50...	1/2 NPT	G1/8	62	128	133	65	34	12	50°	27
VZXF-L...-N34...-V4B2T-50...	3/4 NPT			128	136.5	75		13		32
VZXF-L...-N1...-V4B2T-50...	1 NPT			133	145	90		15		41
VZXF-L...-N114...-V4B2T-50...	1 1/4 NPT			150	163.5	110		17		50
VZXF-L...-N112...-V4B2T-50...	1 1/2 NPT			153	172	120		19		55
VZXF-L...-N2...-V4B2T-50...	2 NPT			167	193	150		21		70

Ordering data

	Line connection	Flow rate Kv [m³/h]	Pressure of medium [bar]	Corrosion resistance CRC ¹⁾	Product weight [g]	Part no.	Type
	1/2 NPT	3.3	0 ... 40	2	1300	3539722	VZXF-L-M22C-M-B-N12-130-M1-V4B2T-50-40
	3/4 NPT	7.5	0 ... 16		1400	3539746	VZXF-L-M22C-M-A-N34-180-M1-V4B2T-50-16
		6.5	0 ... 20		1400	3539747	VZXF-L-M22C-M-B-N34-180-M1-V4B2T-50-20
		1 NPT	12			0 ... 16	1600
	1 NPT	11	0 ... 10		1600	3539785	VZXF-L-M22C-M-B-N1-240-M1-V4B2T-50-10
		1 1/4 NPT	18.5			0 ... 9	2200
	1 1/4 NPT	10.7	0 ... 7		2200	3539818	VZXF-L-M22C-M-B-N114-310-M1-V4B2T-50-7
		1 1/2 NPT	25			0 ... 7	2500
	1 1/2 NPT	17.5	0 ... 6		2500	3539929	VZXF-L-M22C-M-B-N112-350-M1-V4B2T-50-6
		2 NPT	34.5			0 ... 4	3500
	2 NPT	19.5	0 ... 3		3500	3540144	VZXF-L-M22C-M-B-N2-450-M1-V4B2T-50-3

1) Corrosion resistance class CRC 2 to Festo standard FN 940070

Moderate corrosion stress. Indoor applications in which condensation can occur. External visible parts with primarily decorative surface requirements which are in direct contact with a normal industrial environment.