

Flow control and one-way flow control valves VFFF/VFOF



Flow control and one-way flow control valves VFFF/VFOF

Key features

Function

Flow control or one-way flow control valves regulate the piston speed of pneumatic drives during advance and return strokes. This is done through suitable restriction of the flow rate of compressed air in exhaust air or supply air direction. With the one-way

flow control valve VFOF, the flow control function works in one direction only (exhaust air or supply air); the non-return function works in the opposite direction. With the flow control valve VFFF, the flow control function is active in both directions.



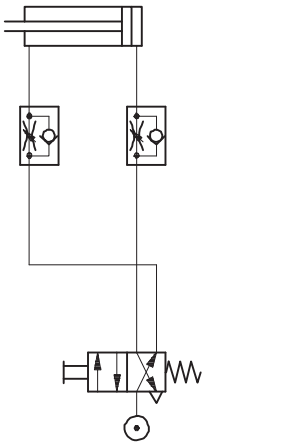
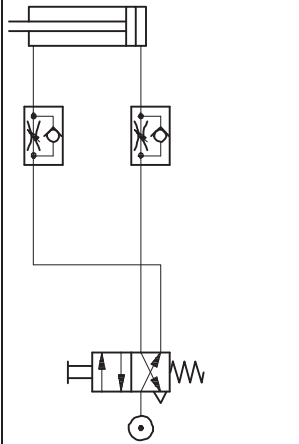
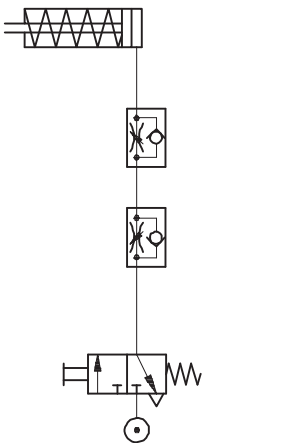
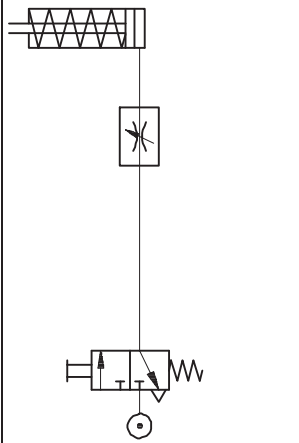

The flow control function creates an adjustable annular gap in the VFOF/VFFF. This gap can be increased or decreased by turning the regulating screw with internal hex. The required restriction can be set with the help of an Allen key.

- Features:
- Minimal height
 - High flow rate
 - Same tool for adjusting the VFFF/VFOF and positioning the position sensors SME/SMT
 - Can be rotated through 360° in assembled state (continuous rotation of the connection must, however, be avoided)

Flow control functions and range of applications			
Application	Description	Application	Description
Double-acting drive with one-way flow control valve			
Exhaust air one-way flow control function		Supply air one-way flow control function	
	Speed adjustment through exhaust air flow control. Uncontrolled supply air and controlled exhaust air move the piston between air cushions (improves motion, even with load changes).		Adjustable speed during advance and return strokes. The flow rate is identical in both directions.
Single-acting drive with one-way flow control valve		Single-acting drive with flow control valve	
Exhaust air and supply air one-way flow control function		Flow control function, in both directions	
	Adjustable speed during advance and return strokes. The flow rate can be adjusted differently for both directions.		Speed adjustment through flow control in both directions is often used with single-acting or small drives. The benefit of this application lies in its simplicity.

Flow control and one-way flow control valves VFFF/VFOF

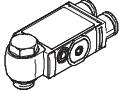
Product range overview

Function	Version	Type	Valve function	Pneumatic connection		→ Page/Internet
				1 (valve)	2 (drive)	
One-way flow control valves 	Standard					
		VFOF	Exhaust air one-way flow control function	QS-6	G $\frac{1}{8}$	4
			Supply air one-way flow control function	QS-6	G $\frac{1}{8}$	
	Function combination					
	VFOF	Exhaust air one-way flow control function	QS-6	G $\frac{1}{8}$	7	
Flow control valves 	Standard					
		VFFF	Flow control function	QS-6	G $\frac{1}{8}$	10

One-way flow control valves VFOF

Type codes

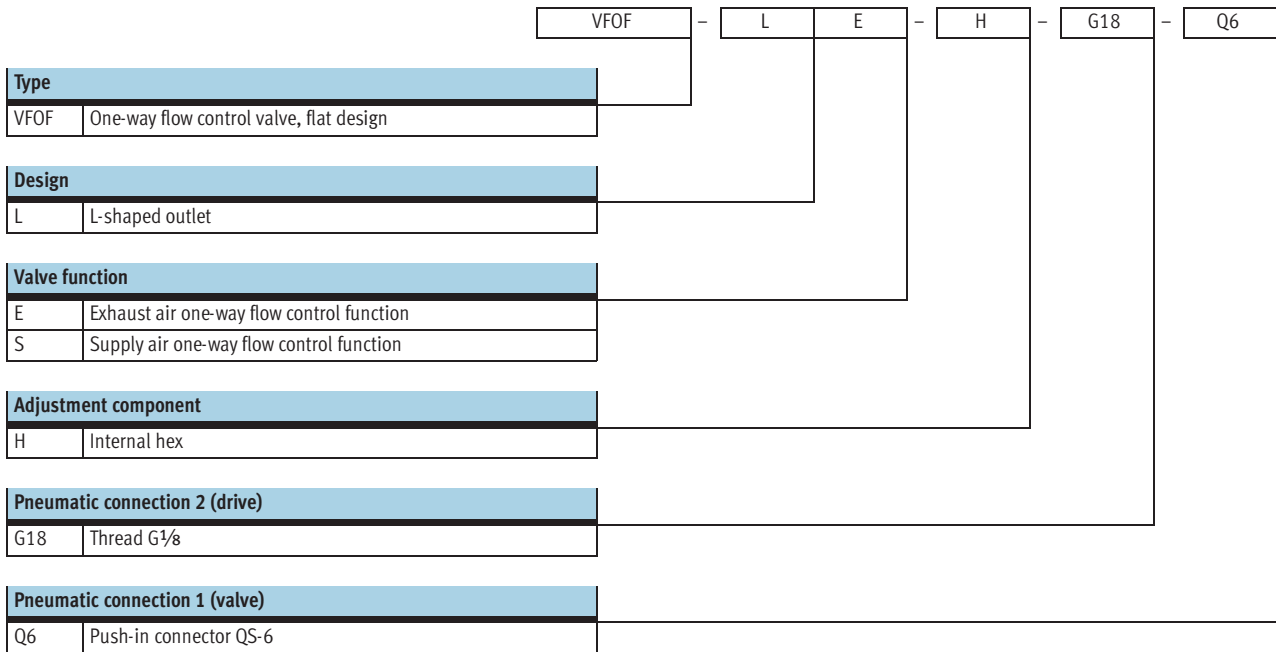

One-way flow control valves VFOF



Technical data

One-way flow control function

Exhaust air

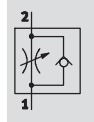
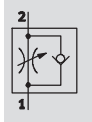
Supply air



-  Flow rate
250 l/min
-  Temperature range
-10 ... +60 °C
-  Operating pressure
0.2 ... 10 bar



General technical data		
Type	VFOF-LE	VFOF-LS
Pneumatic connection 1 (valve)	QS-6	QS-6
Pneumatic connection 2 (drive)	G1/8	G1/8
Valve function	Exhaust air one-way flow control function	Supply air one-way flow control function
Adjustment component	Internal hex	
Actuation type	Manual	
Type of mounting	Screw-in	
Mounting position	Any	

Flow rate characteristic values	
Standard nominal flow rate q_{nN} [l/min] at 6 bar → 5 bar	
Flow control direction	250
Non-return direction	190 ... 300
Standard flow rate q_N [l/min] at 6 bar → 0 bar	
Flow control direction	400
Non-return direction	440 ... 500

Operating and environmental conditions		
Operating pressure	[bar]	0.2 ... 10
Operating medium		Filtered compressed air, lubricated or unlubricated, grade of filtration 40 µm
Ambient temperature	[°C]	-10 ... +60
Temperature of medium	[°C]	-10 ... +60
Storage temperature	[°C]	-10 ... +60

Materials	
Housing, release ring	POM
Threaded plug, hollow bolt, regulating screw	Wrought aluminium alloy
Seals	NBR
Note on materials	RoHS-compliant

One-way flow control valves VFOF

Technical data

Standard nominal flow rate q_{nN} [l/min] and standard flow rate q_N [l/min] as a function of turns of the adjusting screw n

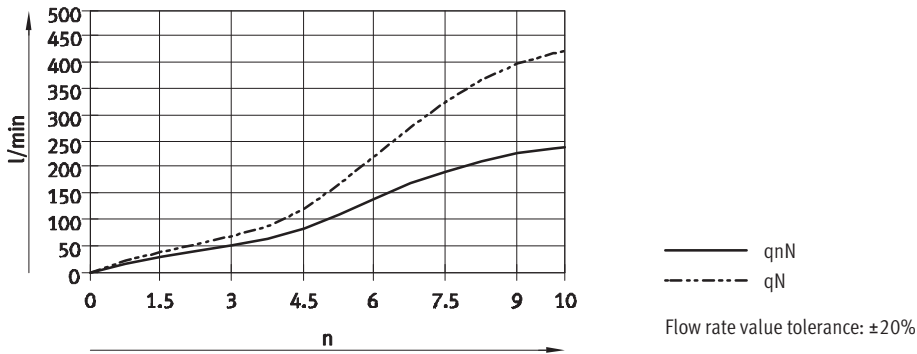

Dimensions

Download CAD data [→ www.festo.com](http://www.festo.com)

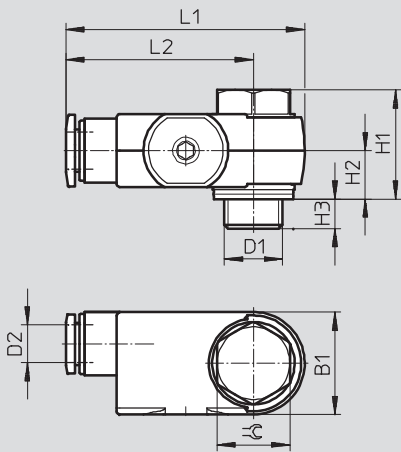

 Note
Max. tightening torque: 3.0 Nm

B1	D1	D2	H1	H2	H3	L1	L2	\approx
17	G $\frac{1}{8}$	QS-6	18	8	5	40	31.5	12

Ordering data

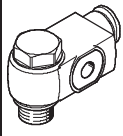
Version	Valve function	Pneumatic connection		Weight [g]	Part No.	Type
		1 (valve)	2 (drive)			
	Exhaust air one-way flow control function	QS-6	G $\frac{1}{8}$	14	547257	VFOF-LE-H-G18-Q6
	Supply air one-way flow control function	QS-6	G $\frac{1}{8}$	14	547258	VFOF-LS-H-G18-Q6

One-way flow control valves VFOF, function combination

Type codes

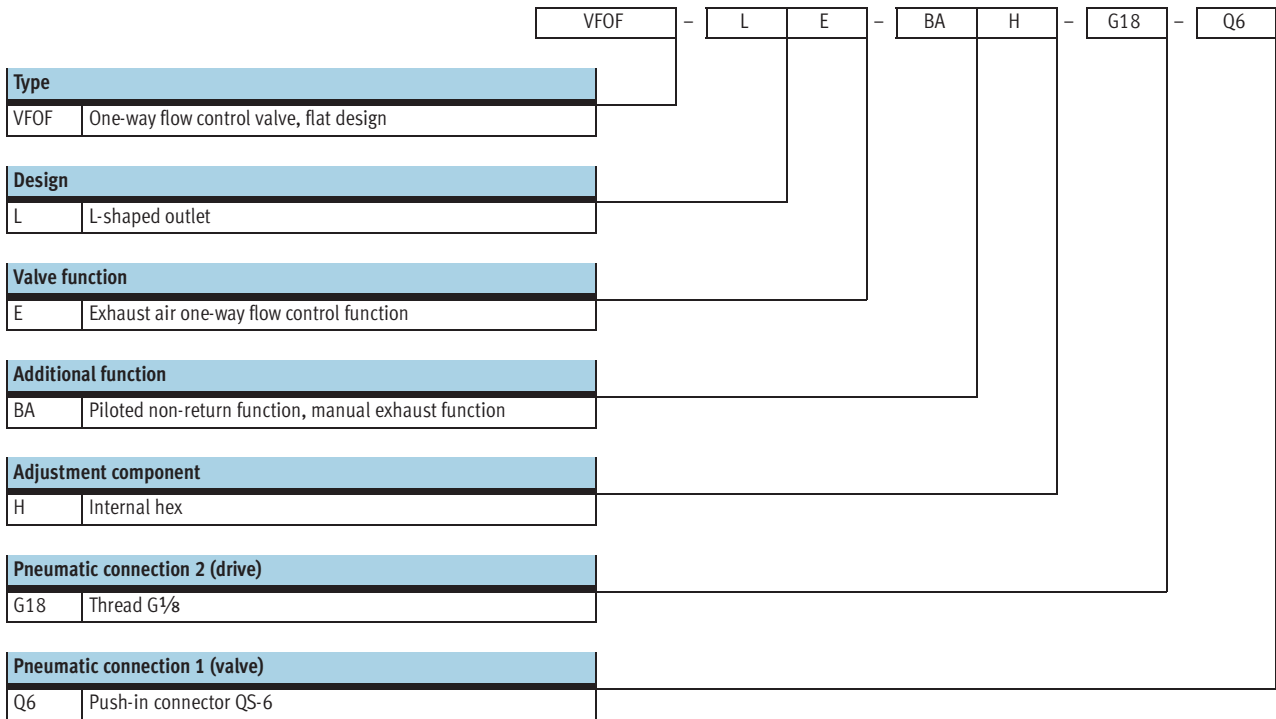



One-way flow control valves VFOF, function combination

Technical data

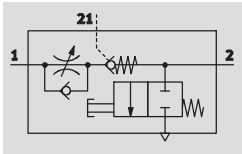
One-way flow control function



-  - Flow rate
200 l/min
-  - Temperature range
-10 ... +60 °C
-  - Operating pressure
0.5 ... 10 bar



The function combination consists of a one-way flow control valve and a piloted non-return valve. It is used to set the advance/return speed of a drive with a temporary intermediate stop.

Exhaust air flow control is active as long as a pilot signal is applied. If no pilot signal is applied, the valve shuts off the exhaust air from the drive. The valve can thus be used for short-duration positioning and braking functions.

- Integrated manual override for exhausting an air volume trapped in the drive
- Pre-assembled sealing ring at pneumatic connection 2 (drive)

General technical data			
Pneumatic connection 1 (valve)	QS-6		
Pneumatic connection 2 (drive)	G1/8		
Pilot air connection 21	QS-6		
Valve function	One-way flow control function		
Adjustment component	Internal hex		
Actuation type	Manual		
Type of mounting	Screw-in		
Mounting position	Any		
Switching time	On	[ms]	5
	Off	[ms]	9

Flow rate characteristic values	
Standard nominal flow rate q_{nN} [l/min] at 6 bar → 5 bar	
Flow control direction	200
Non-return direction, actuated	160 ... 250
Non-return direction, unactuated	160 ... 250
Standard flow rate q_N [l/min] at 6 bar → 0 bar	
Flow control direction	300
Non-return direction, actuated	200 ... 300
Non-return direction, unactuated	200 ... 300

Operating and environmental conditions		
Operating pressure	[bar]	0.5 ... 10
Pilot pressure	[bar]	2 ... 10
Operating/pilot medium	Filtered compressed air, lubricated or unlubricated, grade of filtration 40 µm	
Ambient temperature	[°C]	-10 ... +60
Temperature of medium	[°C]	-10 ... +60
Storage temperature	[°C]	-10 ... +60

Materials	
Housing, swivel connection, release ring	POM
Hollow bolt, regulating screw	Anodised wrought aluminium alloy
Seals	NBR
Note on materials	RoHS-compliant

One-way flow control valves VFOF, function combination

Technical data

Dimensions

Download CAD data → www.festo.com

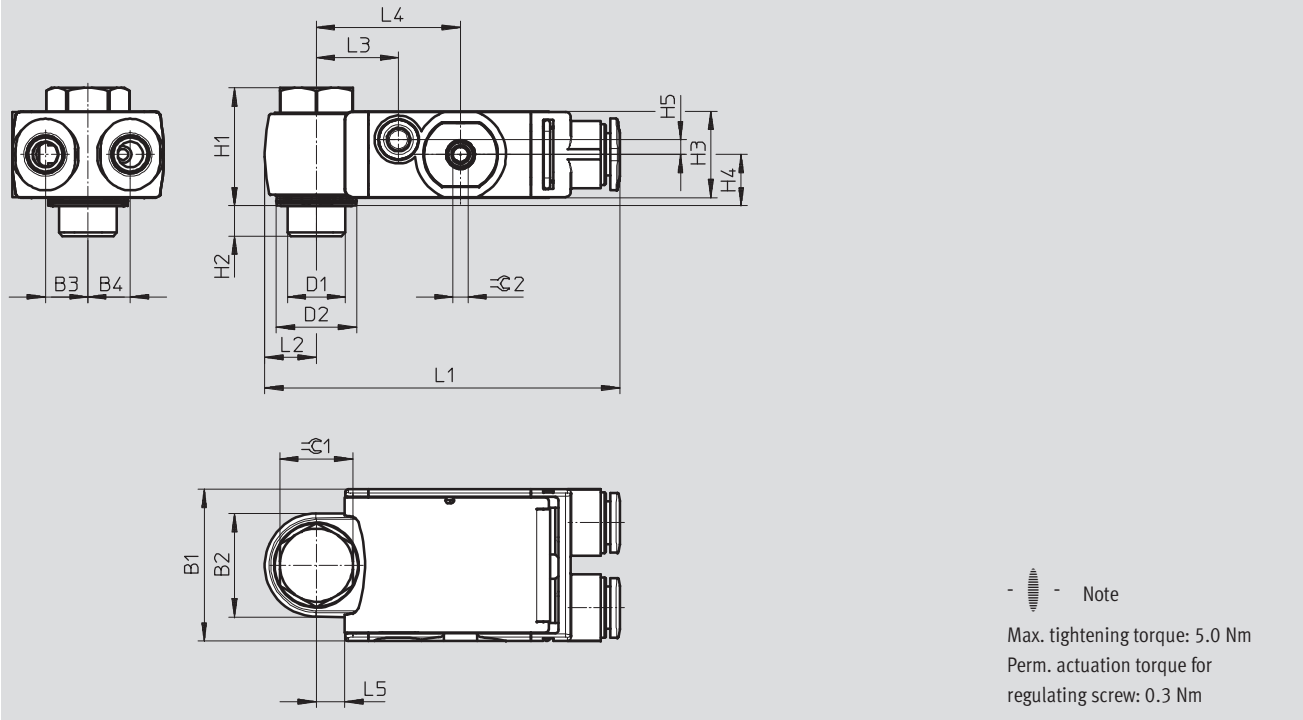

B1	B2	B3	B4	D1	D2	H1	H2	H3	H4	H5	L1	L2	L3	L4	L5	$\varnothing 1$	$\varnothing 2$
25	17.1	7	7	G1/8	13.2	19.4	5	14.2	8.5	2.5	58.5	8.5	13.6	23.8	4.7	12	2.5

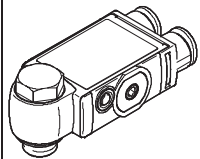
Ordering data						
Version	Valve function	Pneumatic connection		Weight [g]	Part No.	Type
		1 (valve)	2 (drive)			
	One-way flow control function	QS-6	G1/8	27	547884	VFOF-LE-BAH-G18-Q6

Flow control valves VFFF

Type codes

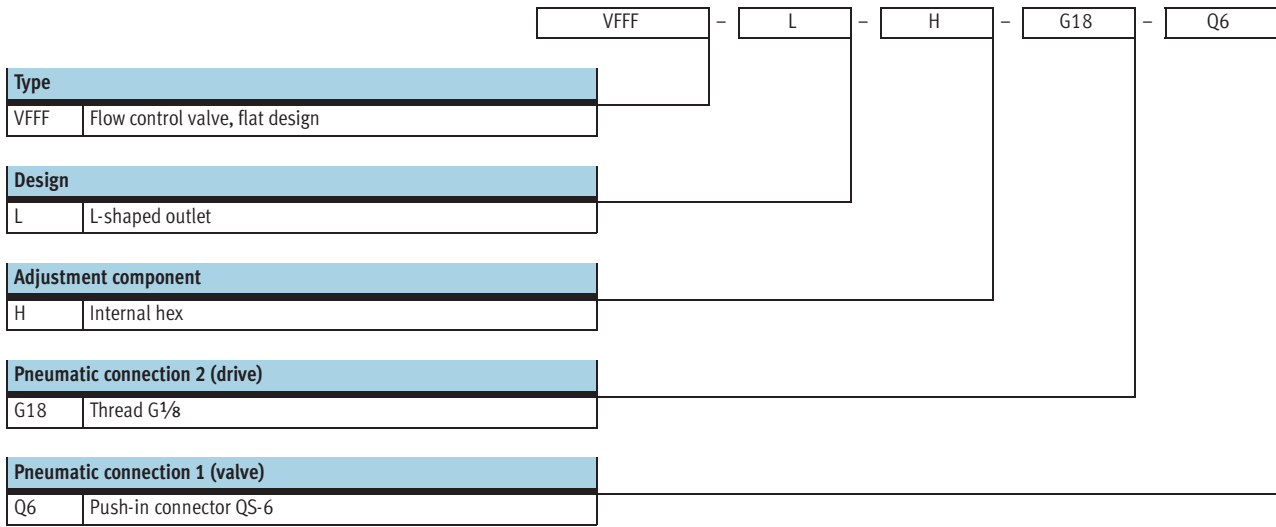



Flow control valves VFFF

Technical data

Flow control function



-  - Flow rate
250 l/min
-  - Temperature range
-10 ... +60 °C
-  - Operating pressure
0.2 ... 10 bar



General technical data	
Pneumatic connection 1 (valve)	QS-6
Pneumatic connection 2 (drive)	G1/8
Valve function	Flow control function
Adjustment component	Internal hex
Actuation type	Manual
Type of mounting	Screw-in
Mounting position	Any

Flow rate characteristic values	
Standard nominal flow rate q _{nN} [l/min] at 6 bar → 5 bar	
Flow control direction	250
Standard flow rate q _N [l/min] at 6 bar → 0 bar	
Flow control direction	0 ... 400

Operating and environmental conditions		
Operating pressure	[bar]	0.2 ... 10
Operating medium		Filtered compressed air, lubricated or unlubricated, grade of filtration 40 µm
Ambient temperature	[°C]	-10 ... +60
Temperature of medium	[°C]	-10 ... +60
Storage temperature	[°C]	-10 ... +60

Materials	
Housing, release ring	POM
Threaded plug, hollow bolt, regulating screw	Wrought aluminium alloy
Seals	NBR
Note on materials	RoHS-compliant

Flow control valves VFFF

Technical data

Standard nominal flow rate q_{nN} [l/min] and standard flow rate q_N [l/min] as a function of turns of the adjusting screw n

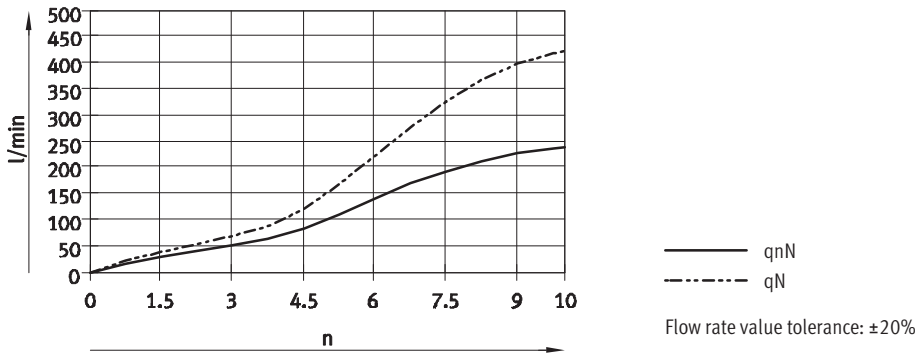

Dimensions

Download CAD data [→ www.festo.com](http://www.festo.com)

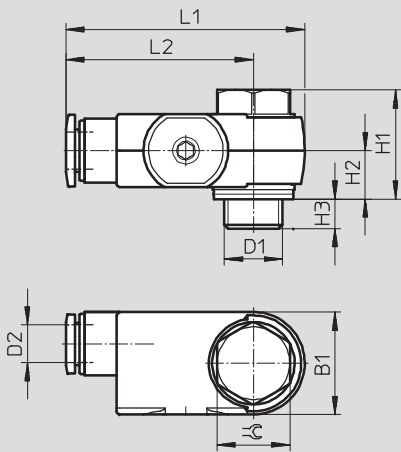

 Note
Max. tightening torque: 3.0 Nm

B1	D1	D2	H1	H2	H3	L1	L2	$\approx \text{C}$
17	G $\frac{1}{8}$	QS-6	18	8	5	40	31.5	12

Ordering data

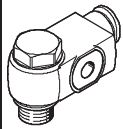
Version	Valve function	Pneumatic connection		Weight [g]	Part No.	Type
		1 (valve)	2 (drive)			
	Flow control function	QS-6	G $\frac{1}{8}$	14	547259	VFFF-L-H-G18-Q6