

- ISO valve terminal
- High flow rates up to 1000 l/min
- Operating voltage either 12 V DC or 230 V AC
- Two valve sizes on the terminal
- Sturdy metal design

- 1 - Type discontinued
Available up until 2010

Valve terminal type 14 VDMA-01/02, ISO 15 407-1

Key features

FESTO

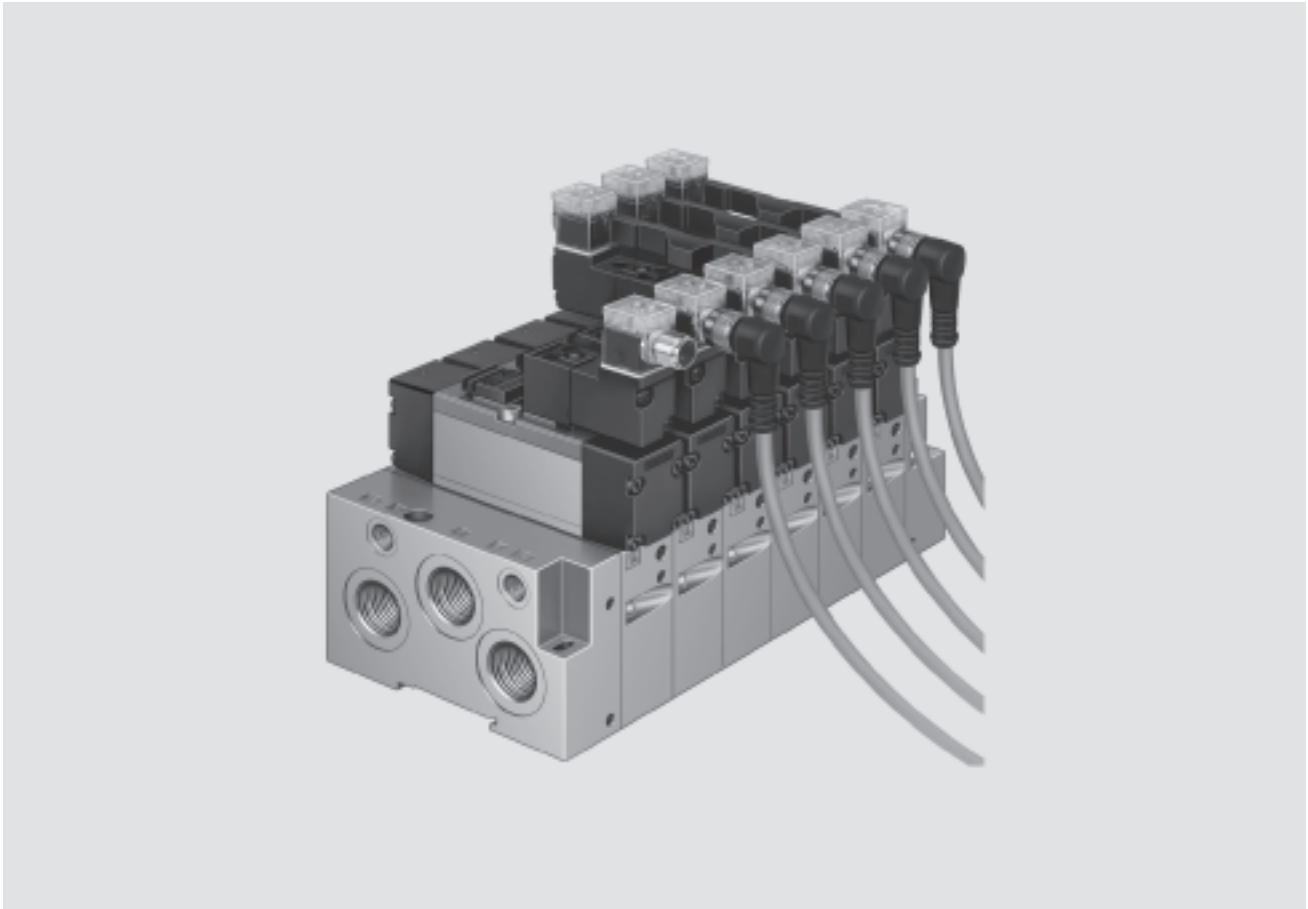

Modular

Festo valve terminals for VDMA 24 563 are of modular design and can be equipped with 2 to 16 standard valves. Fewer valves may also be installed, in which case vacant positions are sealed with blanking plates.

Various electrical connection options such as

- 5-pin central plug M12 to EN 60 947-5-2
- 4-pin central plug M8
- Standard connection (square plug) can be selected.

Flexible

- A valve terminal can have multiple pressure zones and vacuum operation.
- Conversions and extensions are possible at any time.
- Wide range of valve functions, for example 2x 3/2-way valves, in one housing.
- The new generation of valve housings are all the same size. The valve terminals are therefore capable of providing versatile and flexible solutions to a variety of pneumatic control technology requirements.

Reliable

- Sturdy and durable components made of high-quality metal/plastic with IP65 protection.
- The new generation of valves are made of flame-retardant materials.
- Fast error diagnosis thanks to LEDs on the valves or via connector plugs.
- All valves feature manual override.
- Reliability of service through replaceable valves.
- Labelling systems for valves, connection plugs and cables.

Easy to assemble

- Fully assembled and tested unit.
- Captive screws and seals.
- Valves are replaced by undoing just two screws.
- No tube removal required for valve replacement.
- Mounting on H-rail.
- Lower costs for selection, ordering, assembly and commissioning.

Valve terminal configurator

A valve terminal configurator is available to help you select a suitable valve terminal. This makes it much easier for you to find the right product.

Valve terminals are equipped and assembled according to customer requirements. This results in minimal installation time. They are also fully inspected before shipment.



Online via: → www.festo.com

Valve terminal type 14 VDMA-01/02, ISO 15 407-1

Peripherals overview

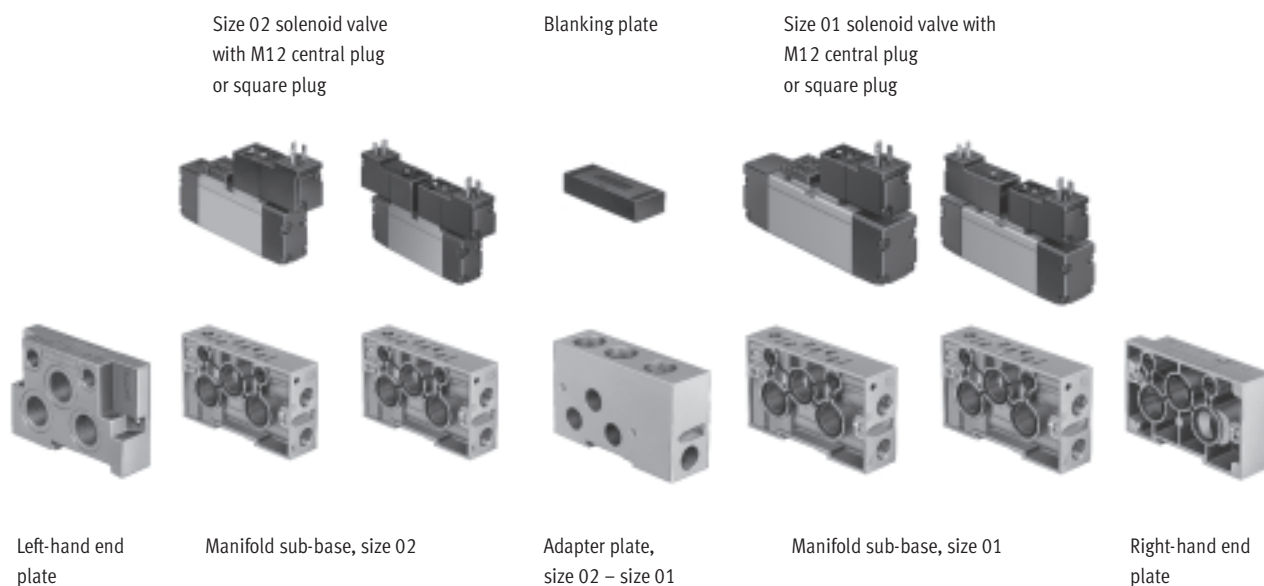

Pneumatic components

The valve terminals include common supply ports and exhausts for all valves. The bus lines can be connected to the end plates, or via adapter plates.

The valve terminals are available in 2 sizes with corresponding flow rates:

- Size 01: 1000 l/min
- Size 02: 500 l/min

It is also possible to combine both sizes.

A wide range of valve types is available:

- 2 x 3/2-way valve
2x closed, 2x open or
1x closed and 1x open
- 5/2-way valve, single solenoid
- 5/2-way valve, double solenoid
- 5/2-way valve, double solenoid, with dominating signal

- 5/3-way valve, mid-position exhausted, pressurised or closed
- Two pressure zones with different pressures (three with mixed sizes) can be created with the help of isolating discs for the supply and exhaust lines.

The standard model valve terminal is equipped with an M8 or M12 central plug. Connection is also possible by means of individual standard plugs upon request.

Terminals are available in sizes 01 and 02. An adapter plate can be used to mix sizes, in which case assembly is started at the left with size 02.

Blanking plates

Blanking plates are used to seal off vacant valve positions.

Creating pressure zones

Different supply pressures are made possible within a single valve terminal by installing an isolating disc between two sub-bases. In doing so, the isolating disc must be inserted from the left into the sub-base. Supply and exhaust are on the right. Usually, only line 1 has to be isolated. In special cases, isolating discs may also be inserted into exhaust lines 3 and 5.

Pilot control

Solenoid actuated valves are used. The standard voltage is 24 V DC. Other voltages are possible (12 V DC, 24 V AC, 110 V AC and 230 V AC). The square plug must be selected for 110 V AC and 230 V AC.

The selection of auxiliary pilot air for the entire valve terminal is made with the corresponding code letter in the order code. This assures selection of the correct valves.

Supply air can be taken from the main line, or from a separate air supply. A separate air supply is required in any event if supply pressure is less than 3 bar (including vacuum). In this case it is advisable to restrict pilot air to 6 bar with a suitable regulator.



Note

The various components which can be installed are included in the order tables.

→ Internet: type 14

- 1 - Type discontinued
Available up until 2010

FESTO

Valve terminal type 14 VDMA-01/02, ISO 15 407-1

Key features – Pneumatic components

Port identification for pneumatic connections

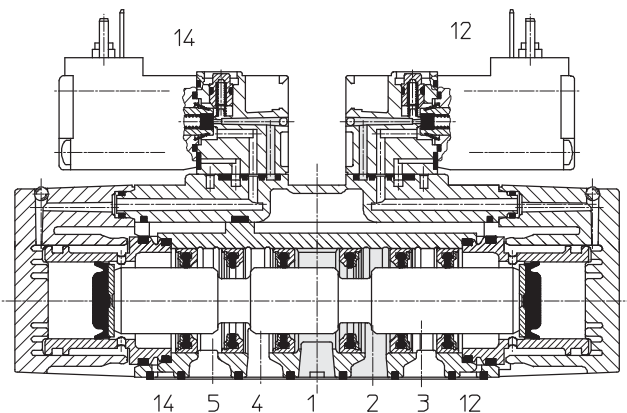

- 1 Compressed air supply
- 2 Working line
- 3 Exhaust, port 2
- 4 Working line
- 5 Exhaust, port 4
- 12 Pilot control exhaust (83, previously 82/84)
- 14 External supply of pilot air (81, previously 12/14)

Port 12 at the end plates is used for exhausting pilot air (83, previously 82/84). Even if pilot air is supplied internally this port must remain open or must be fitted with a silencer.

 Note
Never plug port 12 (83).

Valve terminal with mixed sizes

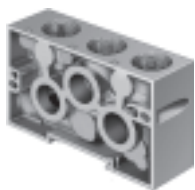

Lines 12 and 14 are interrupted within the adapter plate for adapting size 02 to size 01. These must therefore be fed to both sides of the valve terminal if pilot air is supplied externally.

Isolating discs

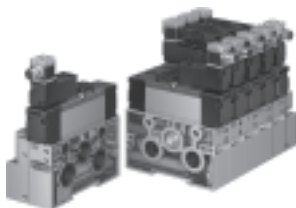

Isolating discs allow for the creation of different pressure zones within a single valve terminal, or separate the exhaust lines in order to prevent the cylinders from influencing one another.

The isolating disc is inserted from the left, so that the valve mounted on the affected sub-base is supplied from, and exhausted to the right.

Manual override

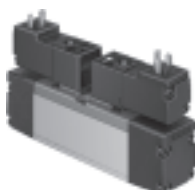

The standard manual override is push-in, and is equipped with spring return.



A detenting manual override can be created with the help of a tool which can be attached to the respective valve as required.

Valve terminal type 14 VDMA-01/02, ISO 15 407-1

Key features – Pneumatic components

Valve function				
Code	Circuit symbol	ISO		Description
		Size 01	Size 02	
without auxiliary pilot air				
K		■	■	<ul style="list-style-type: none"> • 2x 3/2-way valve • Normally closed
N		■	■	<ul style="list-style-type: none"> • 2x 3/2-way valve • Normally open
H		■	■	<ul style="list-style-type: none"> • 2x 3/2-way valve • Normal position 1x closed 1x open
M		■	■	<ul style="list-style-type: none"> • 5/2-way valve, single solenoid • Pneumatic spring
F		■	■	<ul style="list-style-type: none"> • 5/2-way valve, single solenoid • Spring return
J		■	■	<ul style="list-style-type: none"> • 5/2-way valve, double solenoid
D		■	■	<ul style="list-style-type: none"> • 5/2-way valve, double solenoid • Dominating signal at 14
B		■	■	<ul style="list-style-type: none"> • 5/3-way valve • Mid-position pressurised
E		■	■	<ul style="list-style-type: none"> • 5/3-way valve • Mid-position exhausted
G		■	■	<ul style="list-style-type: none"> • 5/3-way valve • Mid-position closed

-  - Type discontinued
Available up until 2010

Valve terminal type 14 VDMA-01/02, ISO 15 407-1

FESTO

Key features – Pneumatic components

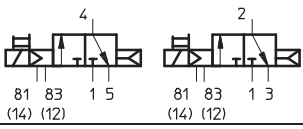
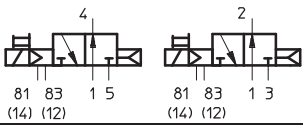
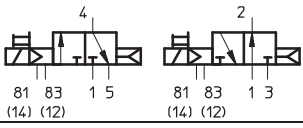
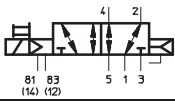
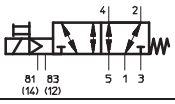
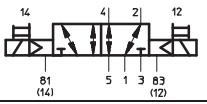
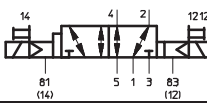
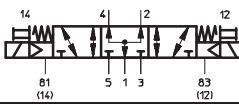
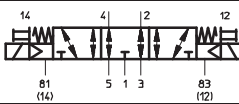
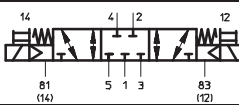
Valve function				
Code	Circuit symbol	ISO		Description
		Size 01	Size 02	
with auxiliary pilot air				
K		■	■	<ul style="list-style-type: none"> • 2x 3/2-way valve • Normally closed
N		■	■	<ul style="list-style-type: none"> • 2x 3/2-way valve • Normally open
H		■	■	<ul style="list-style-type: none"> • 2x 3/2-way valve • Normal position • 1x closed • 1x open
M		■	■	<ul style="list-style-type: none"> • 5/2-way valve, single solenoid • Pneumatic spring
F		■	■	<ul style="list-style-type: none"> • 5/2-way valve, single solenoid • Spring return
J		■	■	<ul style="list-style-type: none"> • 5/2-way valve, double solenoid
D		■	■	<ul style="list-style-type: none"> • 5/2-way valve, double solenoid • Dominating signal at 14
B		■	■	<ul style="list-style-type: none"> • 5/3-way valve • Mid-position pressurised
E		■	■	<ul style="list-style-type: none"> • 5/3-way valve • Mid-position exhausted
G		■	■	<ul style="list-style-type: none"> • 5/3-way valve • Mid-position closed

-  - Note





For vacuum operation valves require a filter. This is to avoid that foreign matter is drawn into the valve (e.g. when using a suction cup).

- 1 - Type discontinued
Available up until 2010

FESTO

Valve terminal type 14 VDMA-01/02, ISO 15 407-1

Key features – Pneumatic components

Horizontal linking				
Code		ISO		Description
		Size 01	Size 02	
A		■	■	Blanking plate
W		■	■	Intermediate plate, size 02/size 01
U		■	■	Isolating discs, line 3/5
V		■	■	Isolating disc, line 1

- 1 - Type discontinued
Available up until 2010

FESTO

Valve terminal type 14 VDMA-01/02, ISO 15 407-1

Key features – Assembly

H-rail mounting of valve terminal

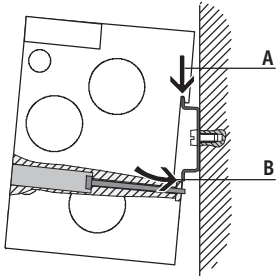

The valve terminal is attached to the H-rail (see arrow A).

The terminal is then rotated on the H-rail and secured by tightening the retaining screw (see arrow B).

-  - Note

Avoid dynamic loads when using H-rail mounting. Otherwise the valve terminal can detach from the H-rail.

Valve terminal type 14 VDMA-01/02, ISO 15 407-1

Key features – Electrical components

Electrical connection

M12 central plug

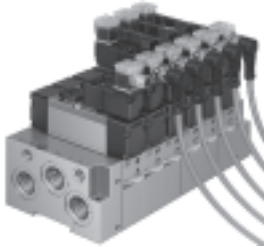

Standard connection

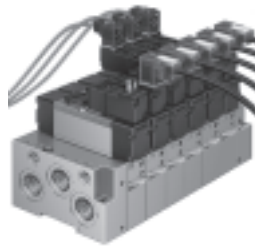

The electrical side of the valve terminal type 14 is established using pre-assembled cables.

The connection to the controller can be established with individual cables.

Pin allocation for M12 central plug

Connection diagrams	Pin	Electrical connection	Cable colour ¹⁾	Designation
2-pin				
	1	–	brown	unused
	2	–	white	unused
	3	com (–)	blue	0 V
	4	Signal (+) Solenoid 14 ²⁾	black	Pilot solenoid coil 14
3-pin				
	1		brown	unused
	2	Signal (+) Solenoid 12 ²⁾	white	Pilot solenoid coil 12
	3	com (–)	blue	0 V
	4	Signal (+) Solenoid 14 ²⁾	black	Pilot solenoid coil 14

1) When using the socket with cable MSSD-EB-M12... or KMEB-1...

2) Connect max. 24 V (–15%/+10%)

Electrical accessories

Code		Description
M12 central plug		
S		Plug socket M12, 4-pin, angled, Pg7
K		Pre-assembled cable with socket M12, 1 m long
Standard connection		
E		Standard plug socket
F		Plug socket with LED and cable, 2.5 m long
G		Plug socket with LED and cable, 5 m long
I		Plug socket for 230 V with cable, 2.5 m long
J		Plug socket for 230 V with cable, 5 m long

-  - Type discontinued
Available up until 2010

Valve terminal type 14 VDMA-01/02, ISO 15 407-1

FESTO

Technical data

-  - Flow rate
VDMA size 01: 1000 l/min
VDMA size 02: 500 l/min

-  - Valve width
Size 01: 26 mm
Size 02: 18 mm

-  - Voltage
24 V DC
12 V DC
24 V AC
110 V AC
230 V AC

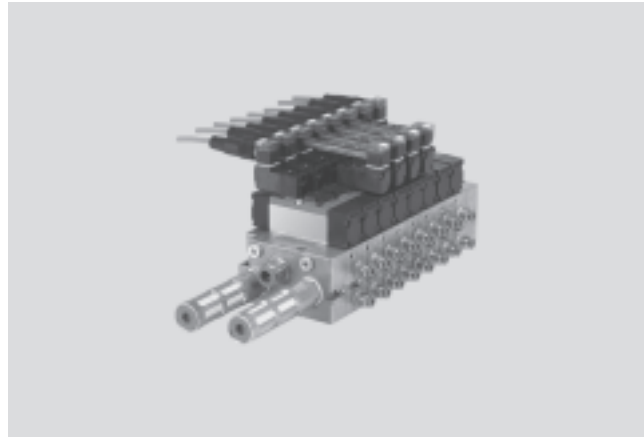

General technical data			
ISO	Size 01	Size 02	
Constructional design, valves	Piston spool valve with sealing ring cartridge		
Width [mm]	27	19	
Nominal size [mm]	8	6	
Type of mounting, valve	On sub-base with connection to VDMA 24 563		
Mounting position	Any		
Manual override	Push-type, self-resetting/detenting (tool)		
Pneumatic connections			
Supply port	1	G $\frac{1}{4}$ (sub-base)	G $\frac{1}{8}$ (sub-base)
Exhaust port	3/5	G $\frac{1}{4}$ (sub-base)	G $\frac{1}{8}$ (sub-base)
Working lines	2/4	G $\frac{1}{4}$ (sub-base)	G $\frac{1}{8}$ (sub-base)
Pilot air port	12/14	M5 (sub-base)	
Pilot exhaust air port	82/84	M5 (sub-base), only valves with code K, N, H	

Pressure range [bar]												
Valve function order code		K	N	H	M	F	J	D	B	E	G	
Operating pressure	Size 01	2 ... 10			-0.9 ... +16							
	Size 02	2 ... 10			-0.9 ... +10							
Operating pressure for valve terminal with internal pilot air supply	Size 01	2 ... 10			2 ... 10				3 ... 10			
	Size 02	2 ... 10			2 ... 10				3 ... 10			
Pilot pressure		2 ... 10			2 ... 10		2 ... 10		3 ... 10			

Minimal pilot pressure p₁₂ as a function of the operating pressure p₁ (with auxiliary pilot air)

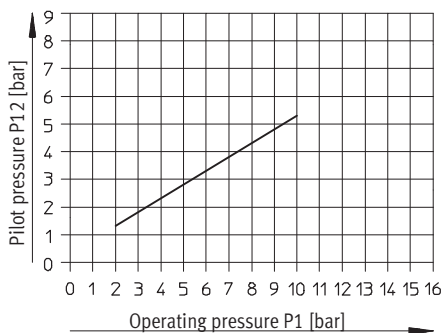

Valve terminal type 14 VDMA-01/02, ISO 15 407-1

Technical data

Valve response times [ms]											
Valve function order code		K	N	H	M	F	J	D	B	E	G
Size 01	on	22	22	22	31	31	–	16	23	23	23
	off	33	33	33	43	43	–	18	52	52	52
	change-over	–	–	–	–	–	18	–	–	–	–
Size 02	on	15	15	15	23	23	–	–	18	18	17
	off	16	16	16	27	27	–	–	30	28	22
	change-over	–	–	–	–	–	16	16	–	–	–

Operating and environmental conditions											
Valve function order code		K	N	H	M	F	J	D	B	E	G
Operating medium		Filtered compressed air, lubricated or unlubricated, or vacuum → 25									
Ambient temperature [°C]		–10 ... +50									
Temperature of medium [°C]		–5 ... +50									
Storage temperature [°C]		–20 ... +40									
Corrosion resistance class CRC ¹⁾		2									

- 1) Corrosion resistance class 2 according to Festo standard 940 070
Components requiring moderate corrosion resistance. Externally visible parts with primarily decorative surface requirements which are in direct contact with a surrounding industrial atmosphere or media such as cooling or lubricating agents.

Electrical data											
Valve function order code		K	N	H	M	F	J	D	B	E	G
Electromagnetic compatibility		Interference emission tested to EN 61 000-6-4, industry Interference immunity ¹⁾ tested to EN 61 000-6-2, industry									
Protection against electric shock (protection against direct and indirect contact to EN 60204-1/IEC 204)		By means of PELV power supply unit (12/14 V DC)									
Operating voltage [V]		<ul style="list-style-type: none"> D.C. voltage: 12, 24 +10%/–15% A.C. voltage: 24, 110/230 ±10%, 50 ... 60 Hz 									
Electrical power consumption [W]		<ul style="list-style-type: none"> D.C. voltage: 1.5 A.C. voltage: Pull: 3, Hold: 2.4 									
Duty cycle		100%									
Protection class to EN 60 529		IP65 (with plug socket)									

Materials											
Valve function order code		K	N	H	M	F	J	D	B	E	G
Valve		Die-cast aluminium, polyacetate (POM)									
Seal		Nitrile rubber (perbunan)									

Product weight [g]		Approx. weights											
Valve function order code		K	N	H	M	F	J	D	B	E	G		
Size 01		320			340			320			270		
Size 02		210			220			210			160		

Nominal flow rate [l/min]													
Valve function order code		K	N	H	M	F	J	D	B	E	G		
Size 01		950			1000								
Size 02		490			500								

-  - Type discontinued
Available up until 2010

Valve terminal type 14 VDMA-01/02, ISO 15 407-1

Technical data

FESTO

Dimensions

Download CAD data → www.festo.com

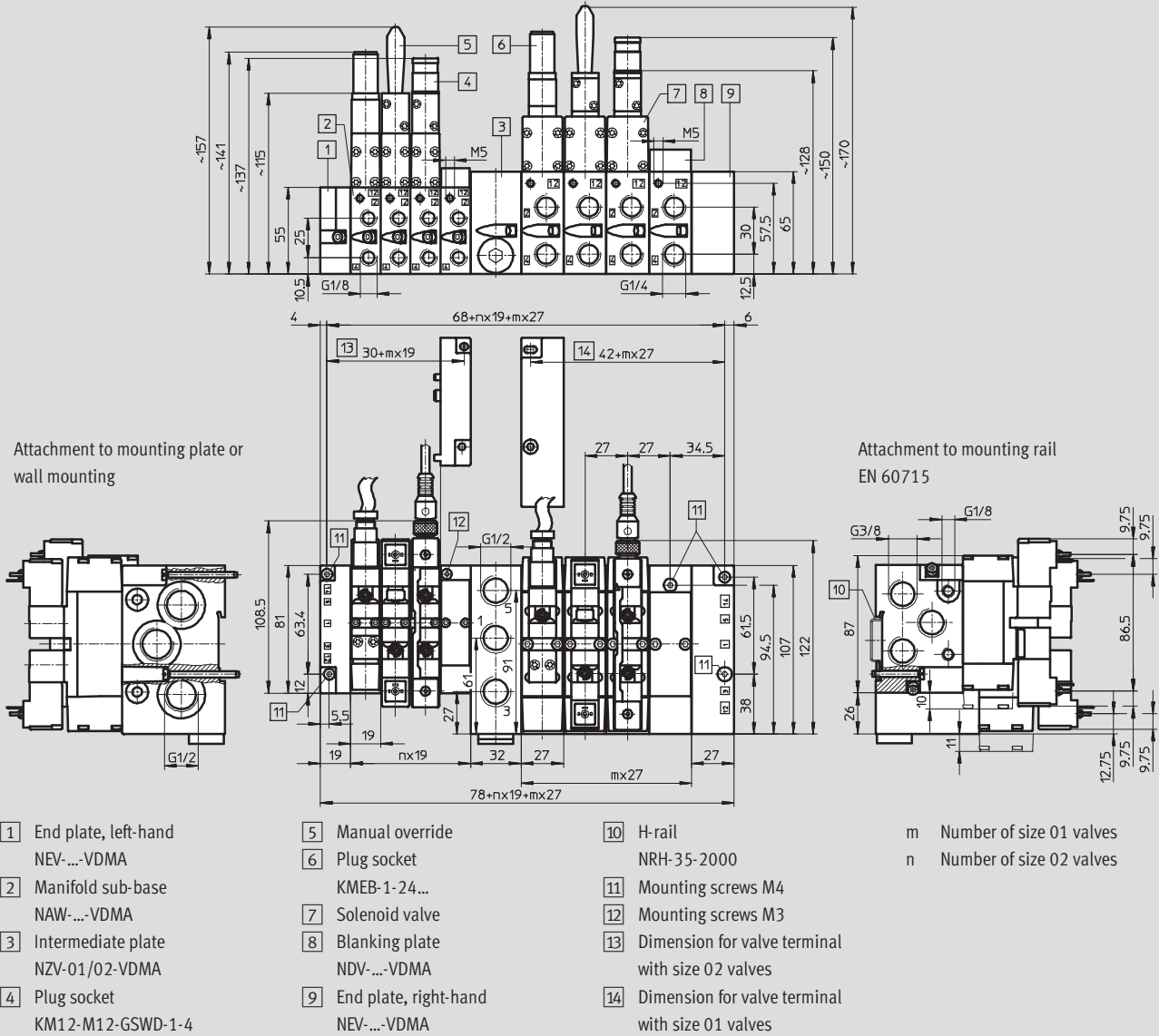

Valve terminal type 14 VDMA-01/02, ISO 15 407-1

Ordering data – Individual valve

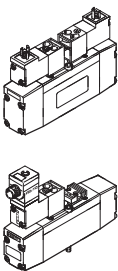
Ordering data						
Valves on individual sub-base						
	Code	Valve function	ISO	Voltage	Type	Part No.
without auxiliary pilot air						
	K	<ul style="list-style-type: none"> • 2x 3/2-way valve • Normally closed 	01	24 V DC	MN2H-2x3G-01	187 970
				12 V DC, 24 V AC	MN2H-2x3G-01-12DCA	191 342
				110 V AC	MN2H-2x3G-01-110VAC	191 344
				230 V AC	MN2H-2x3G-01-230AC	191 346
				24 V DC, central plug	MN2H-2x3G-01-ZSR	191 340
			02	24 V DC	MN2H-2x3G-02	187 976
				12 V DC, 24 V AC	MN2H-2x3G-02-12DCA	191 372
				110 V AC	MN2H-2x3G-02-110VAC	191 374
				230 V AC	MN2H-2x3G-02-230AC	191 376
				24 V DC, central plug	MN2H-2x3G-02-ZSR	191 370
	N	<ul style="list-style-type: none"> • 2x 3/2-way valve • Normally open 	01	24 V DC	MN2H-2x3O-01	187 971
				12 V DC, 24 V AC	MN2H-2x3O-01-12DCA	191 350
				110 V AC	MN2H-2x3O-01-110VAC	191 352
				230 V AC	MN2H-2x3O-01-230VAC	191 354
				24 V DC, central plug	MN2H-2x3O-01-ZSR	191 348
			02	24 V DC	MN2H-2x3O-02	187 977
				12 V DC, 24 V AC	MN2H-2x3O-02-12DCA	191 380
				110 V AC	MN2H-2x3O-02-110VAC	191 382
				230 V AC	MN2H-2x3O-02-230VAC	191 384
				24 V DC, central plug	MN2H-2x3O-02-ZSR	191 378
H	<ul style="list-style-type: none"> • 2x 3/2-way valve • Normal position 1x open 1x closed 	01	24 V DC	MN2H-2x3O-G-01	187 972	
			12 V DC, 24 V AC	MN2H-2x3O-G-01-12DCA	191 358	
			110 V AC	MN2H-2x3O-G-01-110VAC	191 360	
			230 V AC	MN2H-2x3O-G-01-230AC	191 362	
			24 V DC, central plug	MN2H-2x3O-G-01-ZSR	191 356	
		02	24 V DC	MN2H-2x3O-G-02	187 978	
			12 V DC, 24 V AC	MN2H-2x3O-G-02-12DCA	191 388	
			110 V AC	MN2H-2x3O-G-02-110VAC	191 390	
			230 V AC	MN2H-2x3O-G-02-230AC	191 392	
			24 V DC, central plug	MN2H-2x3O-G-02-ZSR	191 386	

- 1 - Type discontinued
Available up until 2010

FESTO

Valve terminal type 14 VDMA-01/02, ISO 15 407-1

Ordering data – Individual valve

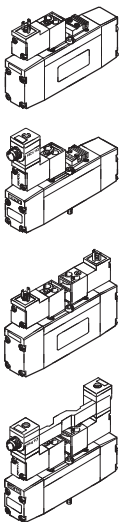
Ordering data						
Valves on individual sub-base						
	Code	Valve function	ISO	Voltage	Type	Part No.
without auxiliary pilot air						
	M	<ul style="list-style-type: none"> • 5/2-way valve, single solenoid 	01	24 V DC	MN2H-5/2-D-01	161 067
				12 V DC, 24 V AC	MN2H-5/2-01-12DCA	187 876
				110 V AC	MN2H-5/2-D-01-110AC	161 880
				230 V AC	MN2H-5/2-D-01-230AC	161 894
				24 V DC, central plug	MN2H-5/2-01-ZSR	191 309
			02	24 V DC	MN2H-5/2-D-02	161 088
				12 V DC, 24 V AC	MN2H-5/2-02-12DCA	187 890
				110 V AC	MN2H-5/2-D-02-110AC	161 908
				230 V AC	MN2H-5/2-D-02-230AC	161 922
				24 V DC, central plug	MN2H-5/2-02-ZSR	191 323
	F	<ul style="list-style-type: none"> • 5/2-way valve, single solenoid • Spring return 	01	24 V DC	MN2H-5/2-D-01-FR	161 069
				12 V DC, 24 V AC	MN2H-5/2-01-FR-12DCA	187 878
				110 V AC	MN2H-5/2-D-01-FR-110AC	161 882
				230 V AC	MN2H-5/2-D-01-FR-230AC	161 896
				24 V DC, central plug	MN2H-5/2-01-FR-ZSR	191 311
			02	24 V DC	MN2H-5/2-D-02-FR	161 090
				12 V DC, 24 V AC	MN2H-5/2-02-FR-12DCA	187 926
				110 V AC	MN2H-5/2-D-02-FR-110AC	161 910
				230 V AC	MN2H-5/2-D-02-FR-230AC	161 924
				24 V DC, central plug	MN2H-5/2-02-FR-ZSR	191 325
J	<ul style="list-style-type: none"> • 5/2-way valve, double solenoid 	01	24 V DC	JMN2H-5/2-D-01	161 071	
			12 V DC, 24 V AC	JMN2H-5/2-01-12DCA	187 880	
			110 V AC	JMN2H-5/2-D-01-110AC	161 884	
			230 V AC	JMN2H-5/2-D-01-230AC	161 898	
			24 V DC, central plug	JMN2H-5/2-01-ZSR	191 319	
		02	24 V DC	JMN2H-5/2-D-02	161 092	
			12 V DC, 24 V AC	JMN2H-5/2-02-12DCA	187 928	
			110 V AC	JMN2H-5/2-D-02-110AC	161 912	
			230 V AC	JMN2H-5/2-D-02-230AC	161 926	
			24 V DC, central plug	JMN2H-5/2-02-ZSR	191 333	
D	<ul style="list-style-type: none"> • 5/2-way valve, double solenoid • Dominating signal 	01	24 V DC	JMN2DH-5/2-D-01	161 073	
			12 V DC, 24 V AC	JMN2DH-5/2-01-12DCA	187 882	
			110 V AC	JMN2DH-5/2-D-01-110AC	161 886	
			230 V AC	JMN2DH-5/2-D-01-230AC	161 900	
			24 V DC, central plug	JMN2DH-5/2-01-ZSR	191 321	
		02	24 V DC	JMN2DH-5/2-D-02	161 094	
			12 V DC, 24 V AC	JMN2DH-5/2-02-12DCA	187 930	
			110 V AC	JMN2DH-5/2-D-02-110AC	161 914	
			230 V AC	JMN2DH-5/2-D-02-230AC	161 928	
			24 V DC, central plug	JMN2DH-5/2-02-ZSR	191 335	

Valve terminal type 14 VDMA-01/02, ISO 15 407-1

Ordering data – Individual valve

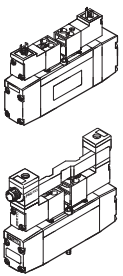
Ordering data									
Valves on individual sub-base									
	Code	Valve function	ISO	Voltage	Type	Part No.			
without auxiliary pilot air									
	B	<ul style="list-style-type: none"> • 5/3-way valve • Mid-position pressurised 	01	24 V DC	MN2H-5/3B-D-01	161 079			
				12 V DC, 24 V AC	MN2H-5/3B-01-12DCA	187 888			
				110 V AC	MN2H-5/3B-D-01-110AC	161 892			
				230 V AC	MN2H-5/3B-D-01-230AC	161 906			
				24 V DC, central plug	MN2H-5/3B-01-ZSR	191 317			
				24 V DC	MN2H-5/3B-D-02	161 100			
			02	12 V DC, 24 V AC	MN2H-5/3B-02-12DCA	187 936			
				110 V AC	MN2H-5/3B-D-02-110AC	161 920			
				230 V AC	MN2H-5/3B-D-02-230AC	161 934			
				24 V DC, central plug	MN2H-5/3B-02-ZSR	191 331			
				E	<ul style="list-style-type: none"> • 5/3-way valve • Mid-position exhausted 	01	24 V DC	MN2H-5/3E-D-01	161 077
							12 V DC, 24 V AC	MN2H-5/3E-01-12DCA	187 886
	110 V AC	MN2H-5/3E-D-01-110AC	161 890						
	230 V AC	MN2H-5/3E-D-01-230AC	161 905						
	02	24 V DC, central plug	MN2H-5/3E-01-ZSR			191 315			
		24 V DC	MN2H-5/3E-D-02			161 098			
		12 V DC, 24 V AC	MN2H-5/3E-02-12DCA			187 934			
		110 V AC	MN2H-5/3E-D-02-110AC			161 918			
	G	<ul style="list-style-type: none"> • 5/3-way valve • Mid-position closed 	01	230 V AC	MN2H-5/3E-D-02-230AC	161 932			
				24 V DC, central plug	MN2H-5/3E-02-ZSR	191 329			
24 V DC				MN2H-5/3G-D-01	161 075				
12 V DC, 24 V AC				MN2H-5/3G-01-12DCA	187 884				
02			110 V AC	MN2H-5/3G-D-01-110AC	161 888				
			230 V AC	MN2H-5/3G-D-01-230AC	161 902				
			24 V DC, central plug	MN2H-5/3G-01-ZSR	191 313				
			24 V DC	MN2H-5/3G-D-02	161 096				
02	12 V DC, 24 V AC	MN2H-5/3G-02-12DCA	187 932						
	110 V AC	MN2H-5/3G-D-02-110AC	161 916						
	230 V AC	MN2H-5/3G-D-02-230AC	161 930						
	24 V DC, central plug	MN2H-5/3G-02-ZSR	191 327						

- 1 - Type discontinued
Available up until 2010

FESTO

Valve terminal type 14 VDMA-01/02, ISO 15 407-1

Ordering data – Individual valve

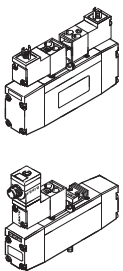
Ordering data									
Valves on individual sub-base									
	Code	Valve function	ISO	Voltage	Type	Part No.			
with auxiliary pilot air									
	K	<ul style="list-style-type: none"> • 2x 3/2-way valve • Normally closed 	01	24 V DC	MN2H-2x3G-01-S	187 973			
				12 V DC, 24 V AC	MN2H-2x3G-01-S-12DCA	191 343			
				110 V AC	MN2H-2x3G-01-S-110AC	191 345			
				230 V AC	MN2H-2x3G-01-S-230AC	191 347			
				24 V DC, central plug	MN2H-2x3G-01-S-ZSR	191 341			
				24 V DC	MN2H-2x3G-02-S	187 979			
			02	12 V DC, 24 V AC	MN2H-2x3G-02-S-12DCA	191 373			
				110 V AC	MN2H-2x3G-02-S-110AC	191 375			
				230 V AC	MN2H-2x3G-02-S-230AC	191 377			
				24 V DC, central plug	MN2H-2x3G-02-S-ZSR	191 371			
				N	<ul style="list-style-type: none"> • 2x 3/2-way valve • Normally open 	01	24 V DC	MN2H-2x30-01-S	187 974
							12 V DC, 24 V AC	MN2H-2x30-01-S-12DCA	191 351
	110 V AC	MN2H-2x30-01-S-110VAC	191 353						
	230 V AC	MN2H-2x30-01-S-230VAC	191 355						
	24 V DC, central plug	MN2Hx-2x30-01-S-ZSR	191 349						
	24 V DC	MN2H-2x30-02-S	187 980						
	02	12 V DC, 24 V AC	MN2H-2x30-02-S-12DCA			191 381			
		110 V AC	MN2H-2x30-02-S-110VAC			191 383			
		230 V AC	MN2H-2x30-02-S-230VAC			191 385			
		24 V DC, central plug	MN2Hx-2x30-02-S-ZSR			191 379			
		H	<ul style="list-style-type: none"> • 2x 3/2-way valve • Normal position 1x open 1x closed 			01	24 V DC	MN2H-2x30-G-01-S	187 975
							12 V DC, 24 V AC	MN2H-2x30-G-01-S-12DCA	191 359
	110 V AC			MN2H-2x30-G-01-S-110AC	191 361				
	230 V AC			MN2H-2x30-G-01-S-230AC	191 363				
24 V DC, central plug	MN2H-2x30-G-01-S-ZSR			191 357					
24 V DC	MN2H-2x30-G-02-S			187 981					
02	12 V DC, 24 V AC			MN2H-2x30-G-02-S-12DCA	191 389				
	110 V AC			MN2H-2x30-G-02-S-110AC	191 391				
	230 V AC			MN2H-2x30-G-02-S-230AC	191 393				
	24 V DC, central plug			MN2H-2x30-G-02-S-ZSR	191 387				

Valve terminal type 14 VDMA-01/02, ISO 15 407-1

Ordering data – Individual valve

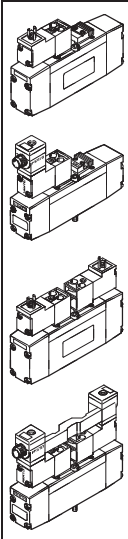
Ordering data						
Valves on individual sub-base						
	Code	Valve function	ISO	Voltage	Type	Part No.
with auxiliary pilot air						
	M	<ul style="list-style-type: none"> 5/2-way valve, single solenoid 	01	24 V DC	MN2H-5/2-D-01-S	161 068
				12 V DC, 24 V AC	MN2H-5/2-01-S-12DCA	187 877
				110 V AC	MN2H-5/2-D-01-S-110AC	161 881
				230 V AC	MN2H-5/2-D-01-S-230AC	161 895
				24 V DC, central plug	MN2H-5/2-01-S-ZSR	191 310
			02	24 V DC	MN2H-5/2-D-02-S	161 089
				12 V DC, 24 V AC	MN2H-5/2-02-S-12DCA	187 891
				110 V AC	MN2H-5/2-D-02-S-110AC	161 909
				230 V AC	MN2H-5/2-D-02-S-230AC	161 923
				24 V DC, central plug	MN2H-5/2-02-S-ZSR	191 324
	F	<ul style="list-style-type: none"> 5/2-way valve, single solenoid Spring return 	01	24 V DC	MN2H-5/2-D-01-FR-S	161 070
				12 V DC, 24 V AC	MN2H-5/2-01-FR-S-12DCA	187 879
				110 V AC	MN2H-5/2-D-01-FR-S-110AC	161 883
				230 V AC	MN2H-5/2-D-01-FR-S-230AC	161 897
				24 V DC, central plug	MN2H-5/2-01-FR-S-ZSR	191 312
			02	24 V DC	MN2H-5/2-D-02-FR-S	161 090
				12 V DC, 24 V AC	MN2H-5/2-02-FR-S-12DCA	187 926
				110 V AC	MN2H-5/2-D-02-FR-S-110AC	161 910
				230 V AC	MN2H-5/2-D-02-FR-S-230AC	161 924
				24 V DC, central plug	MN2H-5/2-02-FR-S-ZSR	191 325
J	<ul style="list-style-type: none"> 5/2-way valve, double solenoid 	01	24 V DC	JMN2H-5/2-D-01-S	161 072	
			12 V DC, 24 V AC	JMN2H-5/2-01-S-12DCA	187 881	
			110 V AC	JMN2H-5/2-D-01-S-110AC	161 885	
			230 V AC	JMN2H-5/2-D-01-S-230AC	161 899	
			24 V DC, central plug	JMN2H-5/2-01-S-ZSR	191 320	
		02	24 V DC	JMN2H-5/2-D-02-S	161 093	
			12 V DC, 24 V AC	JMN2H-5/2-02-S-12DCA	187 929	
			110 V AC	JMN2H-5/2-D-02-S-110AC	161 913	
			230 V AC	JMN2H-5/2-D-02-S-230AC	161 927	
			24 V DC, central plug	JMN2H-5/2-02-S-ZSR	191 334	
D	<ul style="list-style-type: none"> 5/2-way valve, double solenoid Dominating signal 	01	24 V DC	JMN2DH-5/2-D-01-S	161 074	
			12 V DC, 24 V AC	JMN2DH-5/2-01-S-12DCA	187 883	
			110 V AC	JMN2DH-5/2-D-01-S-110AC	161 887	
			230 V AC	JMN2DH-5/2-D-01-S-230AC	161 901	
			24 V DC, central plug	JMN2DH-5/2-01-S-ZSR	191 322	
		02	24 V DC	JMN2DH-5/2-D-02-S	161 095	
			12 V DC, 24 V AC	JMN2DH-5/2-02-S-12DCA	187 931	
			110 V AC	JMN2DH-5/2-D-02-S-110AC	161 915	
			230 V AC	JMN2DH-5/2-D-02-S-230AC	161 929	
			24 V DC, central plug	JMN2DH-5/2-02-S-ZSR	191 336	

- 1 - Type discontinued
Available up until 2010

Valve terminal type 14 VDMA-01/02, ISO 15 407-1





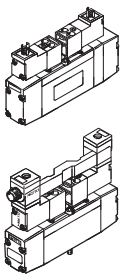





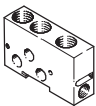

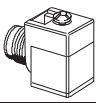
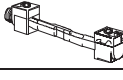

FESTO

Ordering data – Individual valve

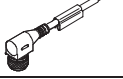
Ordering data								
Valves on individual sub-base								
	Code	Valve function	ISO	Voltage	Type	Part No.		
with auxiliary pilot air								
	B	<ul style="list-style-type: none"> • 5/3-way valve • Mid-position pressurised 	01	24 V DC	MN2H-5/3B-D-01-S	161 080		
				12 V DC, 24 V AC	MN2H-5/3B-01-S-12DCA	187 889		
				110 V AC	MN2H-5/3B-D-01-S-110AC	161 893		
				230 V AC	MN2H-5/3B-D-01-S-230AC	161 907		
			24 V DC, central plug	MN2H-5/3B-01-S-ZSR	191 318			
			02	24 V DC	MN2H-5/3B-D-02-S	161 101		
				12 V DC, 24 V AC	MN2H-5/3B-02-S-12DCA	187 937		
				110 V AC	MN2H-5/3B-D-02-S-110AC	161 921		
				230 V AC	MN2H-5/3B-D-02-S-230AC	161 935		
			24 V DC, central plug	MN2H-5/3B-02-S-ZSR	191 332			
			E	<ul style="list-style-type: none"> • 5/3-way valve • Mid-position exhausted 	01	24 V DC	MN2H-5/3E-D-01-S	161 078
						12 V DC, 24 V AC	MN2H-5/3E-01-S-12DCA	187 887
	110 V AC	MN2H-5/3E-D-01-S-110AC				161 891		
	230 V AC	MN2H-5/3E-D-01-S-230AC				161 905		
	24 V DC, central plug	MN2H-5/3E-01-S-ZSR			191 316			
	02	24 V DC			MN2H-5/3E-D-02-S	161 099		
		12 V DC, 24 V AC			MN2H-5/3E-02-S-12DCA	187 935		
		110 V AC			MN2H-5/3E-D-02-S-110AC	161 919		
		230 V AC			MN2H-5/3E-D-02-S-230AC	161 933		
	24 V DC, central plug	MN2H-5/3E-02-S-ZSR			191 330			
	G	<ul style="list-style-type: none"> • 5/3-way valve • Mid-position closed 			01	24 V DC	MN2H-5/3G-D-01	161 076
						12 V DC, 24 V AC	MN2H-5/3G-01-12DCA	187 885
			110 V AC	MN2H-5/3G-D-01-110AC		161 889		
			230 V AC	MN2H-5/3G-D-01-230AC		161 903		
24 V DC, central plug			MN2H-5/3G-01-ZSR	191 314				
02			24 V DC	MN2H-5/3G-D-02	161 097			
			12 V DC, 24 V AC	MN2H-5/3G-02-12DCA	187 933			
			110 V AC	MN2H-5/3G-D-02-110AC	161 917			
			230 V AC	MN2H-5/3G-D-02-230AC	161 931			
24 V DC, central plug			MN2H-5/3G-02-ZSR	191 328				

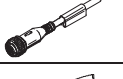
Valve terminal type 14 VDMA-01/02, ISO 15 407-1

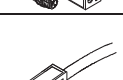
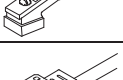
Accessories

Ordering data				
Designation		ISO	Type	Part No.
	Blanking plate	01	NDV-01-VDMA	161 107
		02	NDV-02-VDMA	161 114
	Intermediate plate, size 02/size 01		NZV-01/02-VDMA	161 108
	Isolating discs	01	NSC-1/2-01-VDMA	161 105
		02	NSC-3/8-01-VDMA	161 113
	Identification clip – holder		MN2H-BTZ-10x	161 936
	Inscription label 9x17		IBS-9x17	161 937
	Inscription label 9x20		IBS-9x20	250 702
	Manual override tool, detenting	02	AHB-MEB	157 601
	Plug socket, VDMA valves with central plug, for self-assembly		MSSD-EB	151 687
	Plug socket, VDMA valves with central plug M12 (MONO)		MSSD-EB-M12-MONO	188 024
	Plug socket, VDMA valves with central plug M12 (DUO)	02	MSSD-EB-M12-DUO	188 025
	Cable with socket, angled supply socket M12, 4-pin, 5 m cable		SIM-M12-4WD-5-PU	164 258
	Connecting cable, angled supply socket M12, 5-pin, 5 m cable		NEBU-M12W5-K-5-LE3	541 370
	Cable with socket, plug socket straight M12, 4-pin, 5 m cable		SIM-M12-4GD-5-PU	164 259
	Connecting cable, plug socket straight M12, 5-pin, 5 m cable		NEBU-M12G5-K-5-LE3	541 364
	Cable with socket, plug socket straight M12, 5-pin, 2.5 m cable		SIM-M12-5GD-2,5-PU	175 715
	Cable with socket, plug socket straight M12, 5-pin, 5 m cable		SIM-M12-5GD-5-PU	175 716
	Connecting cable, plug socket straight M12, 5-pin, 2.5 m cable		NEBU-M12G5-K-2,5-LE3	541 330
	Connecting cable, plug socket straight M12, 5-pin, 5 m cable		NEBU-M12G5-K-5-LE3	541 331
	Cable with socket, Cable with socket, M12 cube, 0.5 m		KMEB-2-24-M12-0,5-LED	177 677
	Cable with socket, Cable with socket, M12 cube, 2.5 m		KMEB-2-24-M12-2,5-LED	177 679
	Cable with socket, cube 24 V DC, PUR, 2.5m		KMEB-2-24-2,5-LED	174 844
	Cable with socket, cube 24 V DC, PUR, 5m		KMEB-2-24-5-LED	174 845
	Cable with socket, cube 0 ... 240 V AC, PUR, 2.5m		KMEB-2-230-2,5	174 846
	Cable with socket, cube 0 ... 240 V AC, PUR, 5m		KMEB-2-230-5	174 847
	Connecting cable, M12, 4-pin, 2.5 m		KM12-M12-GSGD-2,5	18 684
	Connecting cable, M12, 4-pin, 5 m		KM12-M12-GSGD-5,0	18 686