

Sensor boxes SRBP, binary

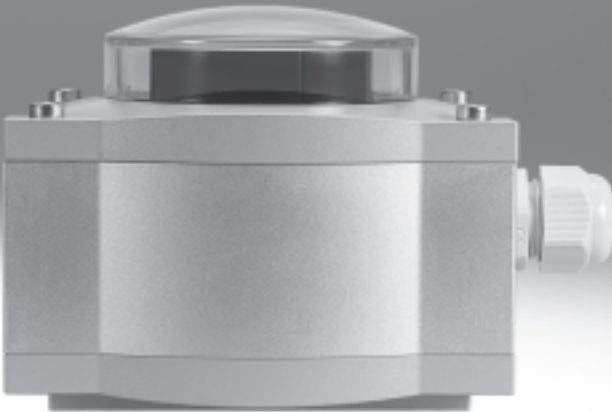

Sensor boxes SRBP, binary

Key features

FESTO

General information

- Whether for transporting, metering or bottling gaseous, paste and liquid media or bulk materials, sensor boxes are used in the process industry as position indicators for the end positions of the semi-rotary actuator
- The binary sensor boxes SRBP not only convert the mechanical open and closed position of the actuator or process valve into electrical output signals, but also permit the optional sensing of a mid-position

Advantages

- Sturdy aluminium housing to IP65 and CRC 3 also enables use in harsh environments
- Mounting on DFPB without additional adapter kit as well as mounting on other actuators via adapter kits as per VDI/VDE 3845
- Clearly visible 3D position indicator offers the option of fast recognition of the current position of the semi-rotary actuator, including from a distance
- Correct indication of the flow direction (I, L, T) of the medium, even with 3-way valves
- Captive screws and name plates offer trouble-free assembly and ordering
- Version available for the ATEX zone 2/22
- Just one product for multiple applications thanks to the wide, adjustable swivel range of up to 270°
- Integrated reed contacts in N/O or changeover contact versions
- The innovative design makes setting the two end positions as well as the mid-position within the wide swivel range of up to 270° quick and easy
- Internal LEDs as setting aid during commissioning
- Optional sensing of the mid-position
- You can find information on the media resistance of the product at → www.festo.com

1 cable connector

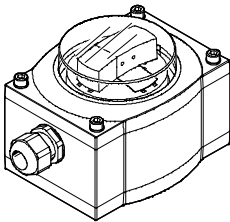

- Power supply for sensor box only

2 cable connectors

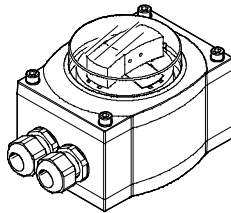

- Common power supply for sensor box and solenoid valve

Sensor boxes SRBP, binary

Peripherals overview

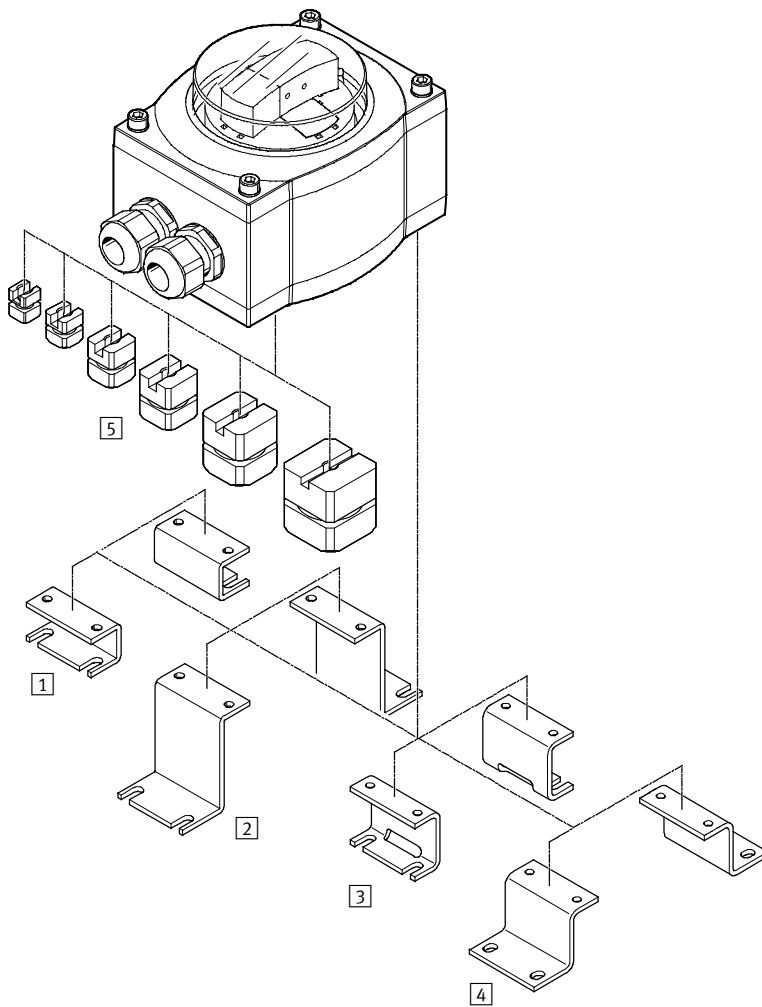

Mounting attachments and accessories		
	Brief description	→ Page/Internet
1	Adapter kit DASB-P1-HA-SB ¹⁾	Hole pattern 30x80 mm, height 20 mm dasb
2	Adapter kit DASB-P1-HL-SB	Hole pattern 30x130 mm, height 50 mm dasb
3	Adapter kit DASB-P1-HB-SB	Hole pattern 30x80 mm, height 30 mm dasb
4	Adapter kit DASB-P1-HC-SB	Hole pattern 30x130 mm, height 30 mm dasb
5	Coupling DARQ-C-S9	For direct mounting on semi-rotary actuators DFPB darq
	Coupling DARQ-C-S11	For direct mounting on semi-rotary actuators DFPB darq
	Coupling DARQ-C-S14	For direct mounting on semi-rotary actuators DFPB darq
	Coupling DARQ-C-S17	For direct mounting on semi-rotary actuators DFPB darq
	Coupling DARQ-C-S22	For direct mounting on semi-rotary actuators DFPB darq
	Coupling DARQ-C-S27	For direct mounting on semi-rotary actuators DFPB darq

1) The adapter kit DASB-P1-HA-SB can optionally be used for all DFPB actuators.

Sensor boxes SRBP, binary

Type codes

SRBP - M - CA1 - BB270 - MSA - 1U - T2P20 - EX2

Function

SRBP	Binary sensor box
------	-------------------

Product version

M	Primarily metal
---	-----------------

Design

C	Sensor box
---	------------

Mechanical interface

A1	Direct mounting, hole pattern 30x80 mm
----	---

Indicator type

BB	Blue/black position indicator
GR	Green/red position indicator
YB	Yellow/black position indicator

Measuring range

270	0 ... 270°
-----	------------

Sensor principle

MS	Floating contact, N/O contact
MW	Floating contact, changeover contact

Mid-position sensing

	None
A	With sensing

Nominal operating voltage

20N	8.2 V DC
1U	24 V AC/DC

Electrical connection

T	Terminal box
---	--------------

Valve connection

	None
2	With valve connection

Cable connector

P20	M20x1.5, polymer
-----	------------------

Temperature range

	Standard -20 ... +80 °C
--	-------------------------

EU certification

	None
EX2	II 3GD

Sensor boxes SRBP, binary

Technical data

- The binary sensor box is a so-called position sensor for semi-rotary actuators and reports the open and closed position of the actuator
- Sensors are based on reed technology



General technical data			... -20N	... -1U
Adjustment range for angle detection	[°]		0 ... 270	
Based on standard			VDI/VDE 3845 (NAMUR)	
Design			Angular	
Mounting position			Any	
Measured variable			Swivel angle	
Measuring principle			Magnetic reed	
Switching element function			→ Page 8	
Mid-position			→ Page 8	
Switching status display			→ Page 8	
Max. output current	[mA]		→ Page 8	
Idle current	[mA]		→ Page 8	
Position indicator			→ Page 8	
Reproducibility of switching point			+/- 1 deg	
Max. switching capacity	Direct voltage DC	[W]	-	10
	Alternating voltage AC	[VA]	-	10
Operating voltage range	Direct voltage DC	[V]	7.8 ... 8.6	19.2 ... 28.8
	Alternating voltage AC	[V]	-	19.2 ... 28.8
Insulation voltage	[V]		50	
Surge capacity	[kV]		0.8	
Voltage drop	[V]		-	0 ... 0.2
Protection against short circuit			No	
Protection against overloading			No	
Output signal			Digital	
Reverse polarity protection			For operating voltage	
Electrical connection			9-pin	
			Screw terminal	
			Plug-in	
Cable connector			M20x1.5	
Max. cable length	[m]		30	
Permissible cable diameter	[mm]		5 ... 13	
Connectable nominal conductor cross section	[mm ²]		2.5	
Product weight	[g]		1,000	
Housing material			Wrought aluminium alloy	
Note on materials			RoHS-compliant	

Sensor boxes SRBP, binary

Technical data

Operating and environmental conditions		... -20N	... -1U
Certification		C-Tick	
		c UL us - Recognized (OL)	
Ambient temperature	[°C]	-20 ... +80 °C	
Protection class		IP65	
CE mark (see declaration of conformity)		To EU EMC Directive	
Electrical protection class		III	
Degree of contamination		3	
Corrosion resistance class CRC ¹⁾		3	

1) Corrosion resistance class 3 according to Festo standard 940 070: Components subject to high corrosion stress. External visible parts in direct contact with industrial atmospheres or media such as solvents and cleaning agents, with a predominantly functional requirement for the surface.

Operating and environmental conditions with explosion protection		... -20N	... -1U
Certification		C-Tick	
		c UL us - Recognized (OL)	
Ambient temperature	[°C]	-20 ... +80 °C	
Protection class		IP65	
CE mark (see declaration of conformity)		To EU EMC Directive	
		To EU Explosion Protection Directive (ATEX)	
ATEX category for gas		II 3G	
Explosion ignition protection type for gas		Ex nA IIC T5 X Gc	
ATEX category for dust		II 3D	
Explosion ignition protection type for dust		Ex tc IIIC T90°C X Dc IP65	
Explosion-proof ambient temperature		-20 °C ≤ Ta ≤ +80 °C	
Explosion protection certification outside the EU		EPL Dc (RU)	
		EPL Gc (RU)	
Electrical protection class		III	
Degree of contamination		3	
Corrosion resistance class CRC ¹⁾		3	

1) Corrosion resistance class 3 according to Festo standard 940 070
Components subject to high corrosion stress. External visible parts in direct contact with industrial atmospheres or media such as solvents and cleaning agents, with a predominantly functional requirement for the surface.

Sensor boxes SRBP, binary

Technical data

Dimensions – Sensor boxes SRBP, binary

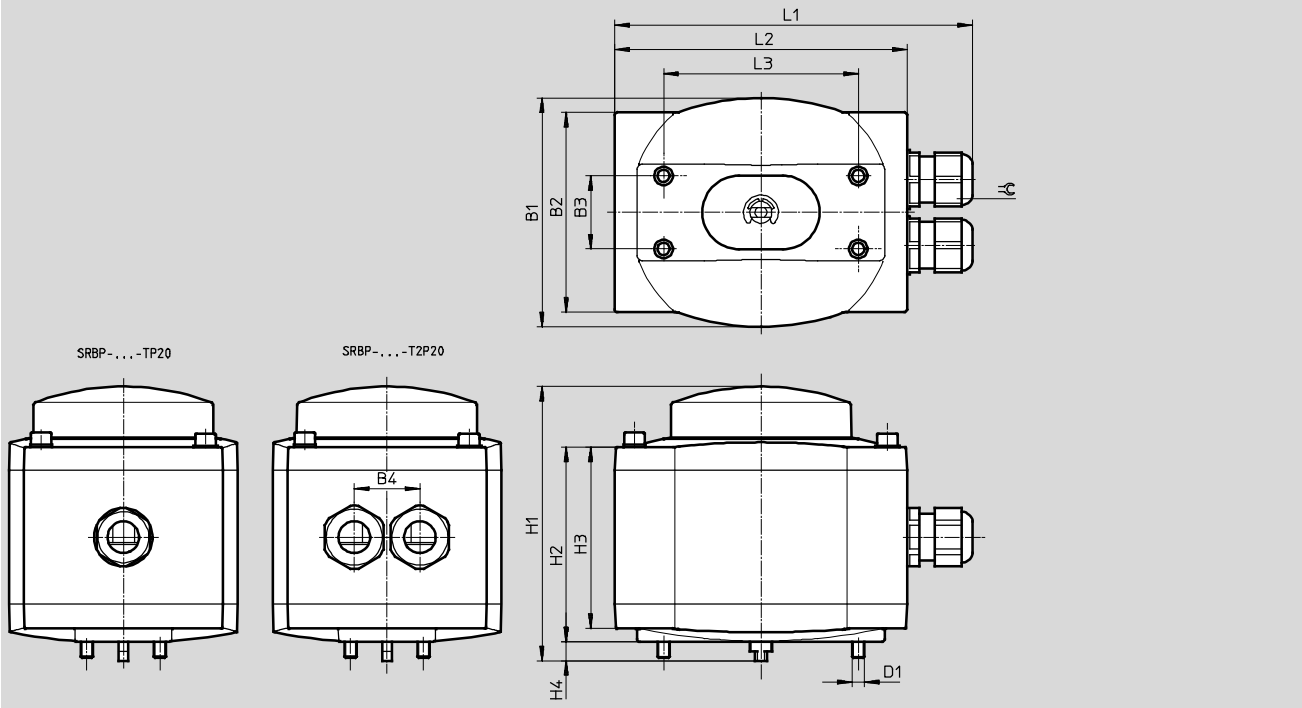

Download CAD data → www.festo.com





Type	B1	B2	B3 ±1	B4	D1	H1	H2	H3	H4	L1	L2 ±1	L3	⌀
SRBP- ...	94	82	30	–	M5	112.7	80	74.5	7.8	148	120	80	24
SRBP- ... -T2P20	94	82	30	27	M5	112.7	80	74.5	7.8	148	120	80	24

Sensor boxes SRBP, binary

Technical data





Ordering data – Sensor boxes SRBP, binary without explosion protection								
	Switching element function	Mid-position	Switching status	Max. output current [mA]	Idle current [mA]	Position indicator	Part No.	Type
	N/O contact	–	LED	500	0 ... 10	Green/red	570402	SRBP-M-CA1-GR270-MS-1U-TP20
	N/O contact	Yes	LED	500	0 ... 10	Green/red	570403	SRBP-M-CA1-GR270-MSA-1U-TP20
	N/O contact	–	LED	500	0 ... 10	Yellow/black	570404	SRBP-M-CA1-YB270-MS-1U-TP20
	N/O contact	Yes	LED	500	0 ... 10	Yellow/black	570405	SRBP-M-CA1-YB270-MSA-1U-TP20
	Changeover switch	–	LED	500	0 ... 10	Green/red	570406	SRBP-M-CA1-GR270-MW-1U-TP20
	Changeover switch	Yes	LED	500	0 ... 10	Green/red	570407	SRBP-M-CA1-GR270-MWA-1U-TP20
	Changeover switch	–	LED	500	0 ... 10	Yellow/black	570408	SRBP-M-CA1-YB270-MW-1U-TP20
	Changeover switch	Yes	LED	500	0 ... 10	Yellow/black	570409	SRBP-M-CA1-YB270-MWA-1U-TP20
	N/O contact	–	LED	500	0 ... 10	Green/red	570410	SRBP-M-CA1-GR270-MS-1U-T2P20
	N/O contact	–	LED	500	0 ... 10	Yellow/black	570411	SRBP-M-CA1-YB270-MS-1U-T2P20

Ordering data – Sensor boxes SRBP, binary with explosion protection								
	Switching element function	Mid-position	Switching status	Max. output current [mA]	Idle current [mA]	Position indicator	Part No.	Type
	N/O contact	–	LED	500	0 ... 10	Blue/black	568249	SRBP-M-CA1-BB270-MS-1U-TP20-Ex2
	N/O contact	–	–	–	–	Green/red	568250	SRBP-M-CA1-GR270-MS-20N-TP20-Ex2
	N/O contact	Yes	–	–	–	Green/red	568251	SRBP-M-CA1-GR270-MSA-20N-TP20-Ex2
	N/O contact	Yes	LED	500	0 ... 10	Green/red	568254	SRBP-M-CA1-GR270-MSA-1U-TP20-Ex2
	N/O contact	–	LED	500	0 ... 10	Green/red	568255	SRBP-M-CA1-GR270-MS-1U-TP20-Ex2
	N/O contact	–	–	–	–	Yellow/black	568256	SRBP-M-CA1-YB270-MS-20N-TP20-Ex2
	N/O contact	Yes	–	–	–	Yellow/black	568257	SRBP-M-CA1-YB270-MSA-20N-TP20-Ex2
	N/O contact	–	LED	500	0 ... 10	Yellow/black	568261	SRBP-M-CA1-YB270-MS-1U-TP20-Ex2
	N/O contact	Yes	LED	500	0 ... 10	Yellow/black	568262	SRBP-M-CA1-YB270-MSA-1U-TP20-Ex2
	Changeover switch	Yes	LED	500	0 ... 10	Green/red	568266	SRBP-M-CA1-GR270-MWA-1U-TP20-Ex2
	Changeover switch	–	LED	500	0 ... 10	Green/red	568267	SRBP-M-CA1-GR270-MW-1U-TP20-Ex2
	Changeover switch	–	LED	500	0 ... 10	Yellow/black	568271	SRBP-M-CA1-YB270-MW-1U-TP20-Ex2
	Changeover switch	Yes	LED	500	0 ... 10	Yellow/black	568272	SRBP-M-CA1-YB270-MWA-1U-TP20-Ex2
	N/O contact	–	LED	500	0 ... 10	Green/red	568274	SRBP-M-CA1-GR270-MS-1U-T2P20-Ex2

Sensor boxes SRBP, binary

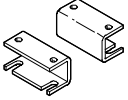
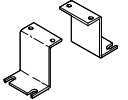
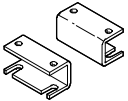
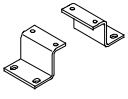
Accessories

FESTO

Dimensions and ordering data			
	Brief description	Part No.	Type
Adapter kit			
	Adapter kit for DRD/DRE, DAPS and DFPB, shaft height 20 mm, hole patterns 80x30 mm	568275	DASB-P1-HA-SB
	Adapter kit for third-party drives, shaft height 50 mm, hole patterns 130x30 mm	568276	DASB-P1-HL-SB
	Adapter kit for DRD/DRE and DAPS, shaft height 30 mm, hole patterns 80x30 mm	572418	DASB-P1-HB-SB
	Adapter kit for DRD/DRE and DAPS, shaft height 30 mm, hole patterns 130x30 mm	572419	DASB-P1-HC-SB
Couplings			
	Couplings for direct mounting of sensor boxes SRBP/SRAP on quarter turn actuators DFPB. Technical data → Internet: dfpb	568674	DARQ-C-S9
		568675	DARQ-C-S11
		568676	DARQ-C-S14
		568677	DARQ-C-S17
		568678	DARQ-C-S22
		568679	DARQ-C-S27
Cable connector			
	Polymer cable connector M20x1.5	568278	NETC-P-M20-P4
	Metal cable connector M20x1.5	568279	NETC-M-M20-P4